

SUMMER/FALL '87 CATALOG  
INCLUDES NEW PRODUCTS!



APPLIED ENGINEERING™  
APPLE PERIPHERALS



## Why Are Apple Owners So Loyal?

People who have the best often are, but in the case of Apple there's more. Apple owners think back to how Apple got started in 1977, just two people working out of a garage and what happened is the talk of Wall Street and the computer industry as well. Many like the fact that Apple only makes computers. Unlike their competition, they don't make typewriters, copiers or telephones. They do just one thing and that's one reason they do it so well.

At Applied Engineering we think the same way. You see, Applied Engineering is the only major hardware manufacturer totally dedicated to the Apple computer. Whereas most of our competitors must divide their time between IBM, Atari, Radio Shack or other computers, our engineers only design products for the Apple. This dedication allows us to be much more familiar with the Apple and those who use them.

We don't expect you to buy an Applied Engineering peripheral on loyalty alone, but when you compare our products to those made by QUADRAM, MICROSOFT, AST and others you'll find out why Applied Engineering means a quality design, innovation, craftsmanship and total Apple compatibility.

The other guys do pretty well considering how busy they are with IBM. But at Applied Engineering, ALL of our work involves the Apple. In fact, all of our employees were Apple owners before they came to work for us. The people in shipping, engineering, quality control and order entry all use Apples at work and at home.

This one track mindedness of ours allows us to offer the largest storage with AppleWorks and Supercalc and our Z-80 card now includes the new 5.1 operating system. We can expand the Apple IIe to over 16 MEGABYTES of memory and the IIc to 1 MEGABYTE, we've got clock cards, music cards, A to D converters, digital controllers, and a BSR system so your Apple can control your whole house with no additional wiring!

Applied Engineering recognizes that we've got to do a better job than our IBM counterparts because we know you're smarter than the average computer buyer, you bought an Apple. You see, our competition has it a little easier, their customers aren't as smart as you. After all, they bought the wrong computer.

So if you need more memory, or 80 columns, or RGB color, or double hi res graphics, if you want to know the time and temperature or other "real world" conditions, if you'd like to run CP/M software, have a RAM disk, increase the storage of AppleWorks or Visicalc, if you want your Apple to play music, talk and sing, if you'd like your Apple to control the lights and appliances in your house, then do what NASA does, what Steve Wozniak does, what Ford does, what the U.S. Government, Hughes Aircraft, Honeywell, Westinghouse, AT&T, and even what Apple computer does, call Applied Engineering. Then you will discover what thousands of companies and over a hundred thousand Apple owners already know, that you can be smart and loyal all at the same time.



**We Set the Standard**

# GS-RAM

## COMPATIBLE WITH IIgs

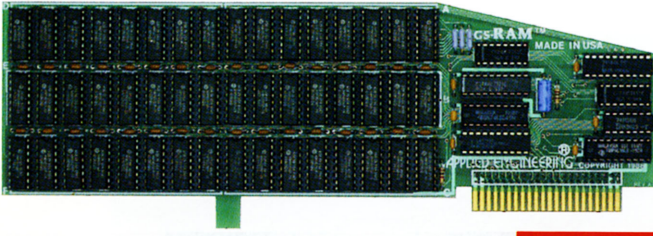

**GS-RAM**  
Up to 1.5 MEG on one card

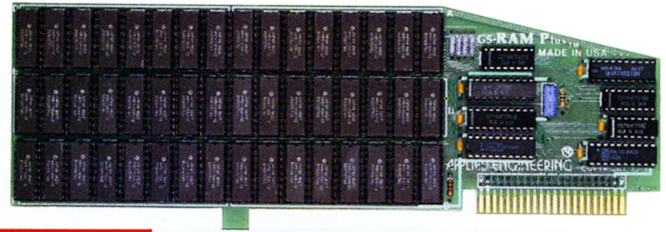

**GS-RAM Plus**  
Up to 6 MEG on one card

**Now the Fastest Memory Card for IIgs with New Disk-Caching Feature**

Remember the 16K cards for the II+ and the 64K cards for the IIe? At the time, that much memory seemed like a lot. But when the owners of these memory cards came to us for more memory, many had to throw away their smaller Apple memory cards or try to sell them. Most of our customers told us that had they known about Applied Engineering's larger memory cards when they bought their Apple, they would have purchased them at the same time.

GS-RAM and GS-RAM Plus are available now, allowing up to 8 MEG of memory expansion. That's 8 times the memory capacity of Apple's card and just look at the benefits that only GS-RAM and GS-RAM Plus have over Apple's card:

- Lower cost
- Has 6 RAM banks (Apple's card has 4)
- Has memory expansion port
- Has ROM expansion port
- No soldered-in RAM chips
- Expandable to 8 MEG
- Expands AppleWorks internal limits
- Built-in Hi-Res self-diagnostic software
- 5 year hassle free warranty (Apple has a 90 day warranty)
- Made in USA

### GS-RAM for More AppleWorks Power

Only GS-RAM and GS-RAM Plus eliminate AppleWorks internal memory limits, increasing the maximum number of records available from 6,350 to over 22,000 and only GS-RAM and GS-RAM Plus increase the number of lines permitted in the word processing mode from 7,250 to over 22,000. And only GS-RAM and GS-RAM Plus offer a built-in printer buffer so you can continue using AppleWorks while your printer is printing. GS-RAM and GS-RAM Plus even expand the number of lines in the clipboard from 255 to 2,042 and will auto segment large files so they can be saved on two or more disks. You can even have Pinpoint of Macroworks and your favorite spelling checker in RAM for instant response. GS-RAM and GS-RAM Plus will even display the time and date right on the AppleWorks screen. Nothing comes close to enhancing AppleWorks so much.

### Turn Your IIgs into a Giant

Simply plug GS-RAM into the IIgs memory expansion slot and you've got up to 8 megabytes of RAM at your fingertips—all of it instantly and automatically recognized by the IIgs. GS-RAM is compatible with all IIgs software, including AppleWorks.

### Grow by Bytes or Megabytes

We offer GS-RAM in two configurations so you can increase your memory 256K at a time (GS-RAM) or a megabyte at a time (GS-RAM Plus). Both offer compatibility, lower cost than other boards, and easy expandability. And both are extremely low in power consumption. A fully expanded GS-RAM operates at only 375 ma, and GS-RAM Plus at only 270 ma (even with 6 megabytes on board!)

### GS-RAM—for Normal Memory Requirements

GS-RAM is available with 256K, 512K, 1 MEG or 1.5 MEG of memory already on board. If you don't need the full 1.5 MEG now, you can choose a GS-RAM with less memory and expand it up to 1.5 MEG in the future—or upgrade to GS-RAM Plus for a small charge.

With an optional piggyback card, you can expand GS-RAM even higher than 1.5 MEG! (Other cards are only expandable to 1 MEG.)

### GS-RAM Plus—for Growing by Leaps and Bounds

GS-RAM Plus is the first Apple memory card to use 1 MEG RAM chips on the main board. It's available with 1 to 6 MEG on board. If you don't need the whole 6 MEG now, you can buy a GS-RAM Plus with less memory and easily expand it in the future.

GS-RAM Plus can be expanded up to 8 MEG with an optional piggyback card.

### Easy Expansion

Both GS-RAM and GS-RAM Plus use standard RAM chips that are readily available and just plug right in. So unlike other cards, you'll find expanding your GS-RAM or GS-RAM Plus easy, convenient and very economical. And with our optional ROM expansion module you can even increase the IIgs's ROM space and all in just one slot.

GS-RAM with 256K .....	<b>\$169</b>
GS-RAM with 512K .....	<b>\$219</b>
GS-RAM with 1 MEG .....	<b>\$299</b>
GS-RAM with 1.5 MEG .....	<b>\$379</b>
GS-RAM Plus with 1 MEG .....	<b>\$459</b>
GS-RAM Plus with 2 MEG .....	<b>\$759</b>
GS-RAM Plus with 3 MEG .....	<b>\$1059</b>
GS-RAM Plus with 4 MEG .....	<b>\$1359</b>
GS-RAM Plus with 5 MEG .....	<b>\$1659</b>
GS-RAM Plus with 6 MEG .....	<b>\$1959</b>
2 MEG RAM/ROM Piggyback .....	<b>CALL</b>



and C.O.D. 214/241-6060

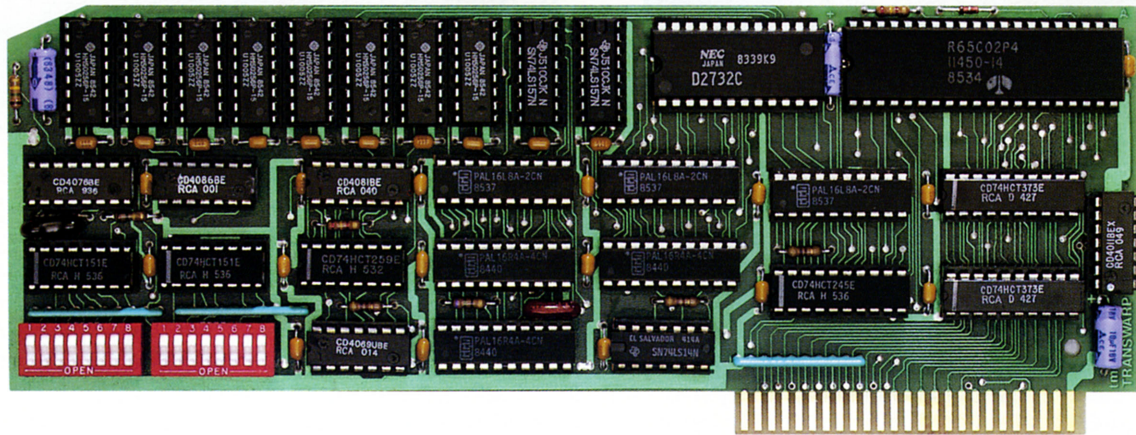

**TransWarp™ . The fastest accelerator you can buy for your Apple™ IIe, II, or II+**

**Computing at warp speed!**

It's an experience you shouldn't miss. And with TransWarp, you won't have to. Because TransWarp will run your software up to 3.6 *times faster* — leaving other accelerators in the stardust! In fact, with the TransWarp accelerator, your IIe or II+ runs about 30% faster than the IIgs.

No more yawning while your Apple™ slowly re-arranges text or calculates spreadsheets. With ultra-fast RAM, TransWarp speeds up *all* Apple software — including AppleWorks, Supercalc 3a, Visicalc and all educational software, graphics and games. And it's compatible with all standard peripheral cards (such as RamWorks and Apple memory cards), Profile and Sider hard disks, 3½" UniDisks, 80-column cards, modems, clock cards, mice and more! You name it, TransWarp accelerates it. There's even a 16 bit upgrade chip available.

**An important difference**

Only TransWarp accelerates your Apple's main memory, ROM *and auxiliary memory*. And with more and more programs residing in auxiliary memory, buying anyone else's accelerator makes less and less sense. TransWarp even works with most D.M.A. devices including the Swyft™ card.

There's one more difference. Since TransWarp doesn't use memory caching, it accelerates *all* software — and not just most of it.

**A cinch to use**

Simply plug TransWarp into any slot in your Apple II, II+ or IIe — including slot 3 in the IIe.

Instantly you'll be computing at speeds you only dreamed about before. And should you ever wish to run at normal speed, simply press the ESC key while turning your Apple on.

Since TransWarp is completely transparent, you won't need pre-boot disks or special software. It's ready to go right out of the package!

**Speed = Productivity**

Imagine the productivity gains you'll achieve when your programs are running over three times faster. TransWarp is so powerful, your Apple will make IBM PCs™ and even ATs™ look like slowpokes — whether you're planning taxes, plotting charts or playing games! Take a look at a few of the features that set TransWarp apart:

- 3.6 MHZ 65C02
- Ultra-fast on-board RAM
- Accelerates main *and* auxiliary memory
- Low power consumption for cool operation
- Totally transparent operation with all software
- Plugs into any slot, including slot 3 on the Apple IIe
- Accelerated 16 bit option available
- 5 year no hassle warranty

TransWarp Accelerator ..... **\$279**  
 16 bit upgrade (may add later) ..... **\$69**

# RAMFACTOR™

**COMPATIBLE WITH IIe, II+ and IIgs**

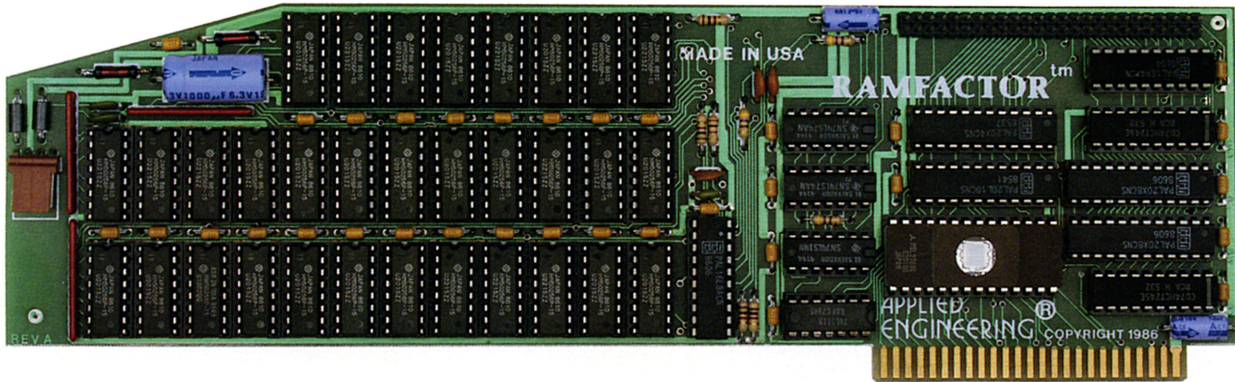

**All the performance, speed, and software compatibility of RamWorks™ in a slot 1 through 7 card**

That's right! Applied Engineering offers you a choice. While RamWorks is the clear winner for the auxiliary slot in a IIe, RamFactor is the standard for slots 1 through 7. Anyone with an Apple II+, Franklin, Laser 128, Apple IIe or IIgs preferring to use slots 1 through 7 can enjoy the speed and performance that until now was only available with RamWorks and GS-RAM.

With RamFactor, you'll be able to instantly add another 256K, 512K, or a full 1 MEG on the main board. And since virtually all software is automatically compatible with RamFactor, you'll immediately be able to load programs into RamFactor for instantaneous access to information. You'll also be able to store more data for larger word processing documents, bigger data bases, and expanded spreadsheets.

### Very Compatible

All the leading software is already compatible with RamFactor. Programs like AppleWorks, Pinpoint, BPI, Managing Your Money, Dollars and Sense, SuperCalc 3A, PFS, MouseWrite, MouseDesk, MouseCalc, Sensible Speller, Applewriter IIe, Business Works, ReportWorks, Catalyst 3.0 and more. And RamFactor is fully ProDos, Dos 3.3, Pascal 1.3 and CP/M compatible. In fact, no other slot 1-7 memory card is more compatible with commercial software.

### AppleWorks Power

There are other slot 1-7 cards that give AppleWorks a larger desktop but, that's the end of their story. RamFactor is the only slot 1-7 card that increases AppleWorks internal memory limits, increasing the records in the database and the maximum number of lines permitted in the word processor, and RamFactor is the only standard slot card that will automatically load AppleWorks into RAM dramatically increasing speed and eliminating the time required to access the program disk. It will even display the time and the date on the AppleWorks screen with any ProDos clock. RamFactor will automatically segment large files so they can be saved on 5¼", 3½", and hard disks. All this performance is available to anyone with an Apple IIe, IIgs, or II+ with an 80 column card. RamFactor, no other standard slot card comes close to enhancing AppleWorks so much.

### The "Instant On" Apple

With the RamCharger battery back-up option, RamFactor will retain programs and data during power failures or even when you turn your computer off. And because RamFactor plugs into slots 1-7, it's the only memory card that can cold boot an Apple without using slow floppy or hard disks. An available "Y" cable allows one RamCharger to power two RamFactors.



### Powerful Program Switcher

With RamFactor, you can organize memory into multiple work areas and switch between them. Each work area can contain different programs and even different operating systems. And with our Battery Back-up option, you can have permanent storage for up to 20 years.

### FEATURES

- 256K to 1 MEG on main board. Expansion connector for possible future expansion to 16 MEG.
  - Fully Apple II Memory Expansion compatible
  - Compatible with Apple IIe, IIgs, II+, Franklin and Laser 128
  - Battery back-up—turn on your Apple and run your favorite programs in less than 1 second!
  - Automatically recognized by ProDos and DOS 3.3, Pascal, and standard CP/M
  - Built-in RamDrive™ and ProDrive™ software—a true RAMdrive not disk caching
  - Systems are directly bootable from RamFactor if desired
  - Built-in self diagnostic software
  - Automatic expansion with AppleWorks 1.3 or 2.0
  - Allows Apple IIe, IIgs and II+ to run your AppleWorks without buying additional software
  - Accelerates AppleWorks
  - Fits any I/O except slot 3
  - Fully socketed and user upgradeable
  - 5 year no hassle warranty
- |                              |              |
|------------------------------|--------------|
| RamFactor with 256K .....    | <b>\$239</b> |
| RamFactor with 512K .....    | <b>\$289</b> |
| RamFactor with 1 MEG .....   | <b>\$369</b> |
| "Y" cable .....              | <b>\$24</b>  |
| Battery Back-up Option ..... | <b>\$179</b> |
| 65C816 16 Bit Card .....     | <b>\$159</b> |

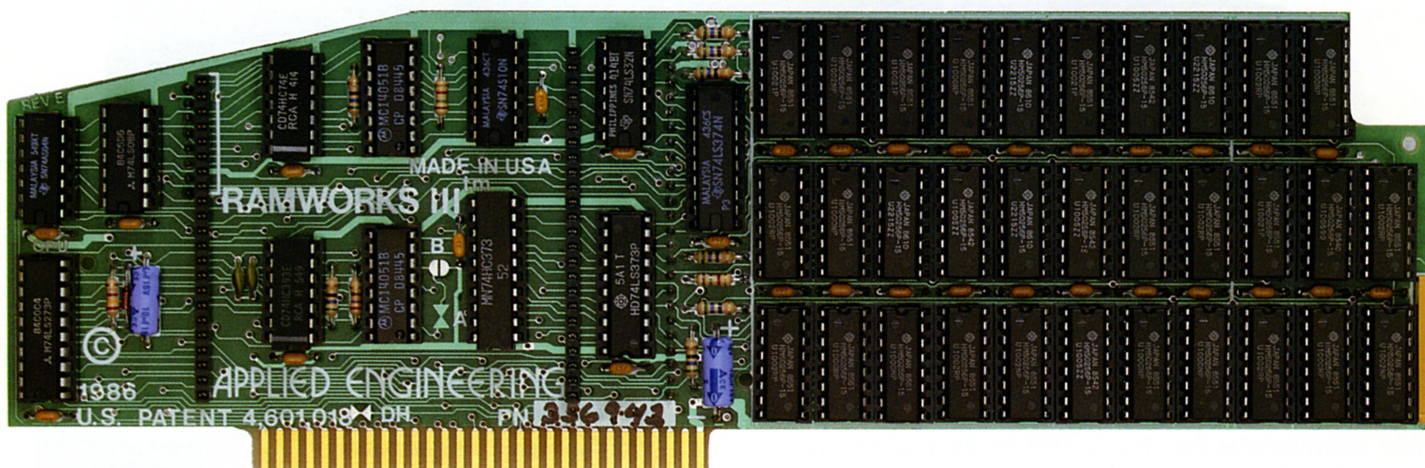

**The best selling, most compatible, most recommended, most expandable card available**

Applied Engineering has solved the most common problem that computer owners have—running out of memory. RamWorks III is the perfect solution because it offers the widest and biggest memory sizes available anywhere.

RamWorks III—A card that plugs into the Apple IIe auxiliary slot and functions EXACTLY like Apple's extended 80 column card but with RamWorks III you get more memory, 80 column text, a 5 year warranty and most importantly, room to grow without using more slots. A design so advanced there's a patent on it (U.S. Patent #4601018).

With the included RamDrive™ software, RamWorks III can also be used as an ultra high speed RAM disk. Depending on the memory size of the RamWorks III card, you can emulate up to 4 disk drives with one RamWorks III card. All at about 20 times faster than mechanical floppy drives and about 5 times faster than a hard disk.

RamWorks III can be used as a solid state disk with DOS 3.3, PASCAL, CP/M and ProDos (up to 5,700 blocks free)!

RamWorks III can be purchased in a wide range of sizes and is user upgradeable using either 64K RAMS or the new 256K RAMS. If you already have an extended 80 column card, no problem. Just unplug the 64K RAMS and plug them into the RamWorks III for an additional 64K. An RGB option is also available, you can order it with your RamWorks III card or add it on at a later date.

RamWorks III saves you time, money, slots and hassle. You'll have additional memory NOW and in the future.

### **The AppleWorks Amplifier**

While RamWorks III is recognized by all memory intensive programs, NO other expansion card (Ram-

Factor excepted) comes close to offering the multitude of enhancements to AppleWorks that RamWorks III does. Naturally, you'd expect RamWorks III to expand the available desktop, after all Applied Engineering was a year ahead of everyone else *including Apple* in offering more than 55K in AppleWorks and we still provide the largest AppleWorks desktops available. But a larger desktop is just part of the story. Just look at all the AppleWorks enhancements that even Apple's own card does not provide and RamWorks III does. With a 256K or larger RamWorks III, all of AppleWorks will automatically load itself into RAM dramatically increasing speed by eliminating all the time required to access the program disk drive. Now switch from word processing to spreadsheet to database at the speed of light with no wear on disk drives.

RamWorks III eliminates AppleWorks' internal memory limits, increasing the maximum number of records available from 1,350 to over 22,000. RamWorks III increases the number of lines permitted in the word processing mode from 2,250 to over 22,000. And RamWorks III (256K or larger) offers a built-in buffer, so you won't have to wait for your printer to stop before returning to AppleWorks. RamWorks III even expands the clipboard from 250 to 2,042 lines. And auto segments large files so they can be saved on two or more disks.

RamWorks III, nothing comes close to enhancing AppleWorks so much.

### **The Most Friendly, Most Compatible Card Available**

Using RamWorks III couldn't be easier because it's compatible with more off-the-shelf software than most other RAM cards (RamFactor and GS-RAM excepted). Popular programs like AppleWorks, Pinpoint, Catalyst,

*More on next page*

MacroWorks, HowardSoft, FlashCalc, The VIP Professional, Managing Your Money, and SuperCalc 3a to name a few (and most hardware add on's like ProFile and Sider hard disks). RamWorks III is even compatible with software written for Apple cards. But unlike other cards, RamWorks III plugs into the IIe auxiliary slot providing our super sharp 80 column text in a completely integrated system while leaving expansion slots 1 through 7 available for other peripheral cards.

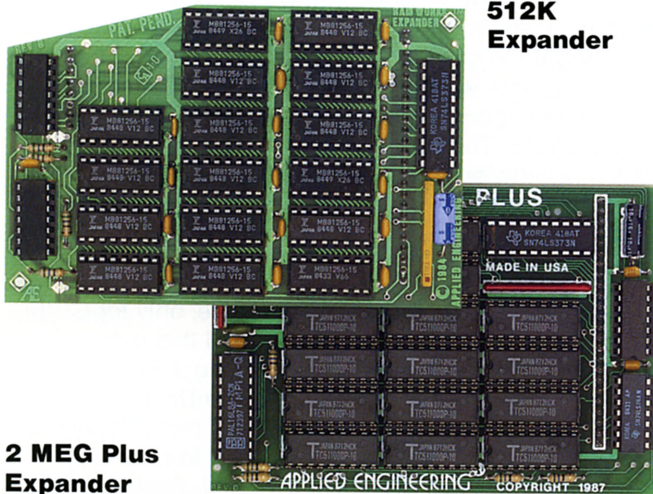

**512K Expander**

**2 MEG Plus Expander**

Should you ever run low on memory with RamWorks III (unlikely) you can add these expander cards to your RamWorks III at any time. And of course, the above expander cards are compatible with the original RamWorks too.

**True 65C816 Bit Power**

RamWorks III has a built-in 65C816 CPU port for direct connection to our optional 65C816 card. The only one capable of linearly addressing more than 1 MEG of memory for power applications like running the Lotus 1-2-3™ compatible program, VIP Professional. Our 65C816 card does not use another slot but replaces the 65C02 yet maintains full 8 bit compatibility.

**It's Popular**

Popularity translates into great software support because software companies can't support all RAM cards, they can only support the ones their customers are likely to own. And software companies appreciate the fact that when they write software for RamWorks II in the IIe, they're also writing software for our memory expansion card for the IIc, Z-RAM. And our customer list reads like the Who's Who of Apple computing with just about every software company in the land buying one, including Apple Computer.

**It's Reasonable**

Applied Engineering's years of experience and wide product line really pays off, and because of our high sales levels we buy most of our I.C. chips factory

direct. So don't let our low prices fool you, they're caused by high volume production. That's why we can offer the most memory for the least money.

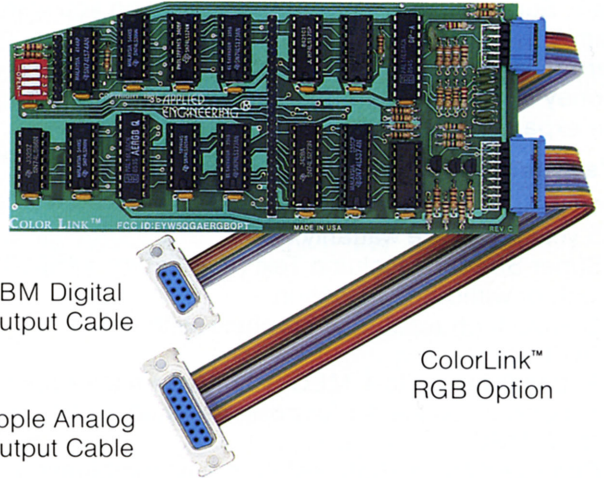

IBM Digital Output Cable

Apple Analog Output Cable

ColorLink™ RGB Option

**It's In Color**

The same slot that's used for memory expansion is also the slot that's used for RGB color display. RamWorks III lets you decide later to add RGB color. For only \$129, an RGB option can be added to RamWorks III to give you double high resolution color graphics and 80 column text. All with razor sharp, vivid brilliance that's unsurpassed in the industry. The RGB option does not waste another valuable slot, but rather plugs into the back of RamWorks III with no slot 1 interference (works on the original RamWorks too).

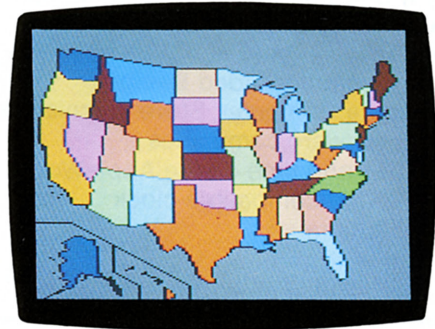

You'll appreciate the multiple text colors (others only have green) that come standard. But the RamWorks III RGB option is more than just the ultimate in color output because unlike others, it's fully compatible with all the Apple standards for RGB output control, making it more compatible with off-the-shelf software. With its FCC certified design, you can use almost any RGB monitor because only the new RamWorks III RGB option provides both Apple standard analog and IBM standard digital outputs (cables included). And remember, you can order the RGB option with your RamWorks III or add it on at a later date.

*More on next page*

**It Corrects Mistakes**

Let's say you bought some other RAM card (and that's a mistake) and your RAM card is not being recognized by AppleWorks, Advanced VisiCalc, FlashCalc, Supercalc 3A, or other programs and you want RamWorks III. No problem. The memory chips on the card that you have now, which is where most of the money is, can be unplugged and then plugged into the expansion sockets on RamWorks III.

**It's Got It All**

- 15 Day Money Back Guarantee
- 5 year no hassle warranty
- Super Sharp 80 Column Text (U.S. Patent #4601018) with or without RGB option
- Double high resolution graphics (with or without RGB option)
- Expandable up to 1 MEG (1024K) on main board
- Expansion Connector for possible future expansion to 16 MEG
- Can use 64K or 256K RAMS in any combination
- Linear Addressing Co-Processor Port
- Automatic AppleWorks Expansion up to 3017K desktop
- Accelerates AppleWorks
- Built-in AppleWorks printer buffer
- 100% compatible with all standard IIe software
- RamDrive™ and ProDrive™, the ultimate disk emulator software, included free
- Compatible, RGB option featuring ultra high resolution color graphics and multiple text colors, with cables for both Apple and IBM type monitors
- Built-in self-diagnostic software
- Lowest power consumption (U.S. Patent #4601018)
- Takes only one slot—No slot 1 interference
- Software industry standard
- 16 bit option
- Advanced Computer Aided Design
- Used by Apple Computer, Steve Wozniak and virtually all software companies
- Displays date and time on the AppleWorks screen with any ProDos compatible clock
- Much, much more!

RamWorks III with 64K .....	\$179
RamWorks III with 256K .....	\$199
RamWorks III with 512K .....	\$249
RamWorks III with 1 MEG .....	\$329
RamWorks III with 1.5 MEG .....	\$489
RamWorks III with 3 MEG .....	\$1499
512K Expander .....	\$199
2 MEG Plus Expander with 1 MEG .....	\$499
2 MEG Plus Expander .....	\$799
RGB Option (can be added later) .....	\$129
16 Bit Option, 65C802 (can be added later) ...	\$69
16 Bit Option, 65C816 (can be added later) ..	\$159

**LOW COST SOFTWARE OPTIONS  
RamDrive™ (now included FREE!)**

RamDrive will give you a high speed solid state disk drive. The RamDrive software features audio-visual access indicators, easy setup for turnkey operation, and easy menu driven documentation. The program can be modified and is copyable. If you have a 64K RamWorks III, RamDrive will act as half a disk drive. If you have a 128K RamWorks III, RamDrive will act as a full disk drive. As you go past 128K of memory, RamWorks III will act as multiple disks, so all one megabyte can be as a solid state disk. Either way, your programs will load and save over 20 times faster. RamDrive is compatible with APPLESOFT, ProDos and DOS 3.3. The disk also includes a high speed RAM copying program. RamDrive is another disk drive only 20 times faster and no whirring, clicking or waiting!

**CP/M RamDrive™**

CP/M RamDrive is just like RamDrive, only for CP/M. CP/M RamDrive runs on any Z-80 card that runs standard CP/M, i.e. Applied Engineering Z-80 Plus, Microsoft Soft Card of PCPI. CP/M RamDrive will dramatically speed up the operation of most CP/M software because CP/M normally goes to disk fairly often. Fast acting software like dBase II, Wordstar and Turbo Pascal becomes virtually instantaneous when used with CP/M RamDrive.

- Z-80 Plus, Microsoft version ..... **\$29**
- PCPI APPLI-CARD version ..... **\$29**

**VC IIe Expander**

VC IIe Expander gives owners of Visicalc IIe and Advanced Visicalc IIe increased storage. When used with VC IIe you'll get 141K workspace (128K RamWorks III or larger required). When used with Advanced VC IIe you'll get 131K with a 128K RamWorks III, 253K with a 256 RamWorks III and 437K with a 512K RamWorks III.

**VIP Professional**

A new generation spreadsheet, with almost unlimited memory and unlimited power and a real Macintosh style interface. VIP Professional has the same commands and features as Lotus 1-2-3™. No other spreadsheet even compares. \$249 list price.

- Enhanced Apple IIe/IIc  
(requires 256K min. RamWorks or Z-RAM .... **\$219**
- Apple IIgs ..... **\$269**

**Pinpoint's AppleWorks Accessories with Ram Enhancement Software for 128K Enhanced IIe/IIc**

Together a \$118 value..... **\$79**



and C.O.D. 214/241-6060



## COMPARISON BETWEEN RAMWORKS, RAMFACTOR and GS-RAM

Many of the features and benefits of RamWorks III, RamFactor, and GS-RAM are the same; however, there are differences that we would like to point out so that you can make the best choice.

Most importantly, RamWorks III is specially designed for the Apple IIe and GS-RAM is specially designed for the Apple IIgs. These cards will not work on a II+, Franklin or other compatibles. RamFactor is compatible with the IIe, II+, IIgs, Franklin, Laser 128 and most compatibles.

All three cards are equally compatible with commercially prepared programs. However, RamWorks and GS-RAM offer more power with AppleWorks but RamFactor can be battery backed-up in smaller sizes. If your primary application is AppleWorks and you have a IIe or a IIgs you may prefer RamWorks or GS-RAM respectively. But, if you prefer to use slots 1-7, RamFactor would be the better choice. All three products are so good you'll be happy no matter which one you choose.

<b>Capability</b>	<b>RamWorks® III</b>	<b>RamFactor™</b>	<b>GS-RAM™ GS-RAM Plus™</b>
Computer compatibility	Apple IIe	Apple II+, IIe, IIgs and compatibles	Apple IIgs
Maximum memory on main card	1 Megabyte	1 Megabyte	1.5 MEG GS-RAM 6 MEG GS-RAM Plus
Expander cards (for expansion beyond main card)	512K, 2 MEG (custom 16 MEG)	None, "Y" connector for 2 RamFactors (custom to 16 MEG)	2 MEG RAM/ROM Card
Compatible slot	Auxiliary slot	Slots 1-7 except 3	Memory expansion
RAM disk	Disk based	EPROM/disk based	IIgs control panel
Software standard	Yes	Yes	Yes
Battery back-up	No (custom on 4 to 16 MEG)	Yes	No on main board Yes on 2 MEG expander
AppleWorks compatibility	All versions	Versions 1.3 or 2.0	Versions 1.3 or 2.0
Maximum number of records in database	22,600	22,600	22,600
Maximum number of lines in word processor	22,600	22,600	22,600
Lines in WP and DB clipboard	2042	2042	2042
Autoload AppleWorks	Yes	Yes	Yes
Displays time on screen with ProDos clock	Yes	Yes	Yes
Auto-segments large files	Yes	Yes	Yes
AppleWorks printer buffer	Yes	No	Yes
Fully socketed and user upgradeable	Yes	Yes	Yes
16 bit option (65C816)	Yes	No	No

Comparisons made using AppleWorks 2.0, however similar performance is obtained using older AppleWorks versions.

## AE EXTENDED 80 COLUMN CARD

COMPATIBLE WITH IIe

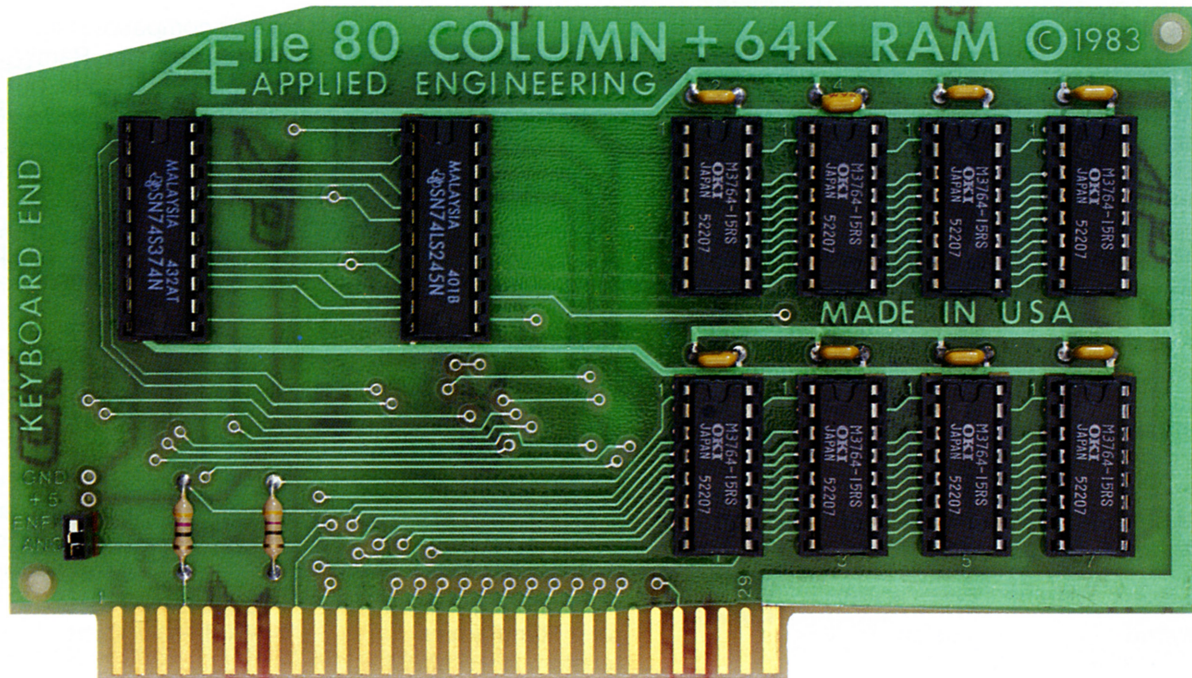

### FEATURES

- Plugs into the Apple IIe auxiliary slot and functions EXACTLY like Apple's Extended 80 Column Card
- Expands your Apple IIe to 128K memory
- Provides an 80 column text display
- Compatible with Apple IIe 80 column and extended 80 column card software
- Can be used as a solid state disk drive to make your programs run up to 20 times FASTER (will act as half a drive)
- Permits your IIe to use the new double high resolution graphics
- Automatically expands Appleworks to 55K available
- Automatically expands Visicalc to 95K storage in 80 columns!
- ProDos will use the AE Extended 80 Column Card as a high speed disk drive
- Documentation included, we show you how to use all 128K
- 5 year no hassle warranty

**\$99**

## 16K RAMCARD

COMPATIBLE WITH APPLE II AND II+

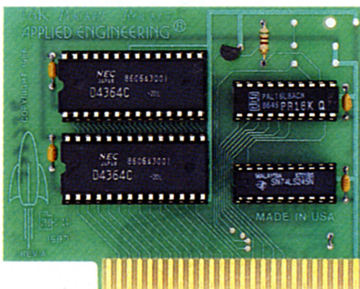

### 16K Pocket Rocket

- 16K memory expansion card for the Apple II and II+ fully compatible with Applesoft, CP/M and Pascal. Plugs into slot 0.
- Low power - reduced chip count
- Allows II+ to run ProDos
- No jumper cable or chips to remove
- 5 year no hassle warranty

**\$79**

# VIEWMASTER 80™

COMPATIBLE WITH II+ and FRANKLIN

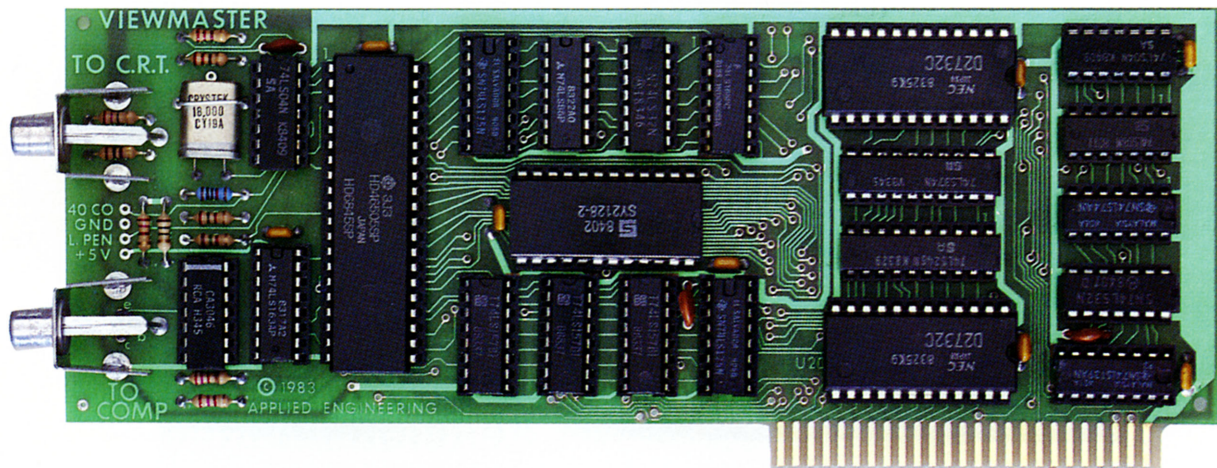

**There used to be about a dozen 80 column cards for the Apple, Now There's Only ONE!**

	BUILT-IN SOFTSWITCH	SHIFT KEY SUPPORT	LOW POWER DESIGN	80 COLUMN HOME	7X9 DOT MATRIX	LIGHT PEN INPUTS	40 COLUMN OVERRIDE	INVERSE CHARACTERS
<b>VIEWMASTER 80</b>	<b>YES</b>	<b>YES</b>	<b>YES</b>	<b>YES</b>	<b>YES</b>	<b>YES</b>	<b>YES</b>	<b>YES</b>
SUPRTERM	NO	YES	NO	NO	NO	NO	YES	YES
WIZARD 80	NO	NO	NO	NO	YES	NO	YES	YES
VISION 80	YES	YES	NO	NO	YES	NO	NO	NO
OMNIVISION	NO	YES	NO	NO	NO	NO	YES	YES
VIEWMAX 80	YES	YES	NO	NO	YES	NO	NO	YES
SMARTERM	YES	YES	NO	NO	NO	YES	YES	NO
VIDEOTERM	NO	YES	YES	NO	YES	YES	NO	YES

Each Viewmaster 80 includes our powerful AppleWorks expand software, allowing AppleWorks to run on the II+ with only 64K (or more) memory. (We recommend the RamFactor memory card, but most compatible Apple memory cards will work.) The software provides our full range of AppleWorks enhancements, including expanded records and word processor lines, multi-disk saving, time and date display on screen with any ProDos clock, and more!

## FEATURES

- All new design
- 80 characters by 24 lines
- Fully compatible with all Apple languages and software. Includes AppleWorks enhancement software
- Very sharp 7X9 character matrix with true descenders
- Highest compatibility with existing 80 column software
- Power and input connector for light pen
- Very low power consumption through the use of CMOS devices
- High speed (18 MHZ) scroll rate
- Upper and lower case characters with true descenders, both inverse and normal
- All on-screen editing functions are supported
- User defineable cursor shape
- Compatible with Apple II, II+ and IIe
- 5 year no hassle warranty

TOTAL compatibility is the secret to the Viewmaster 80's great success. The Viewmaster 80 works with all 80 column applications including CP/M, Pascal, Wordstar, Format II, Easywriter, Applewriter II, Supertext 80, Zardax, Apple PI, Letter Perfect, dBase II, Visicalc, Multiplan, and hundreds of others.

Viewmaster 80 delivers a super sharp, state of the art display, with a 7x9 character matrix giving you a clear, easily readable character.

Whether you're buying your first 80 column card or replacing a less powerful one, you'll appreciate the many extra features built in to the Viewmaster 80. There are no options available for the Viewmaster 80 because every feature of every 80 column card is already in the Viewmaster 80. The Viewmaster 80 is compatible with the Apple II, II+, and Franklin computers.

**\$149**



and C.O.D. 214/241-6060

COMPATIBLE WITH IIe, II+ and IIgs

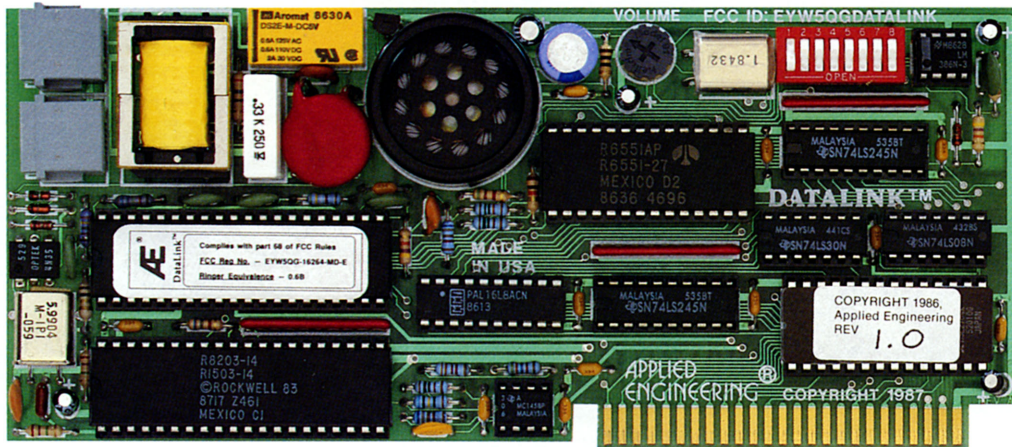

Now you can tap into a world of information—without draining your resources. Our DataLink™ modem lets your Apple II+, IIe or IIgs communicate with other computers, download free software from networks and bulletin boards, access database services and more. For a remarkably low price.

**The world at your fingertips**

With the DataLink modem, you'll be able to draw information from thousands of databases. Send and receive electronic mail—even overseas. Join clubs and bulletin boards to exchange software or solve computing problems with other Apple users. Download free public domain software. And share files with personal computers and mainframes.

DataLink offers high speed, reliable telecommunications for your Apple IIe, IIgs or II+. DataLink is the newest, most advanced internal 1200 BAUD modem available for the Apple. A design so advanced it couldn't have been made before mid 1987.

**There's nothing missing on DataLink**

Unlike most other modems, DataLink comes with its own easy-to-use communications software in ROM and on disk that supports macros, file transfers, on-line time display, data capture and datascopes mode. The software also allows you to store hundreds of phone numbers for auto dialing and log on.

A compact design allows DataLink to fit in any slot—including slots 1 and 2 of the IIgs with a cooling fan installed. DataLink operates at 1200 or 300 baud. Built-in diagnostics check for accuracy of data transmission, and DataLink lets you track the progress of calls either electronically or via an on-board speaker.

**Introductory offers from popular networks included**

When you purchase DataLink, you'll get a fee-waived membership to The Source worth \$49.95. \$60.00 worth of free on-line time from News Net. A free \$50.00

subscription to the Official Airline Guide. A free subscription to the GENie network worth \$18.00! And information on MCI Mail.

**FEATURES**

- 1200 and 300 baud
- Hayes® "AT" command compatible but with more commands
- 1200 or 300 BPS half or full duplex
- Bell 212A and 103 compatible
- Communications software in ROM and on disk
- Works in any slot of the IIe, IIgs or II+ (except 0)
- Auto-dial, auto-answer
- Call progress detection electronically or with speaker (speaker has volume control)
- Built-in self test
- Two built-in phone connectors
- Phone cable included
- 5 year no hassle warranty

**\$219**



and C.O.D. 214/241-6060

# SERIAL PRO

COMPATIBLE WITH IIe, II+ and IIgs

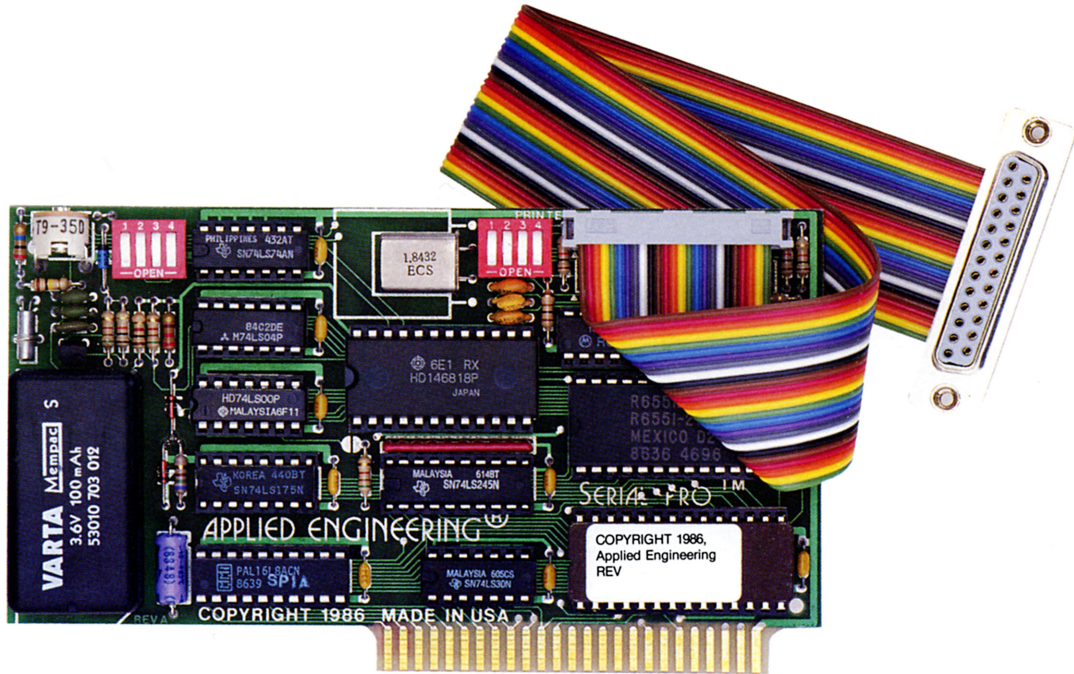

Serial Pro is a powerful multifunction card for the Apple IIe, II+, IIgs and Franklin computers. Serial Pro combines a powerful serial port for interfacing to either a printer, or a modem or other serial device, with a full function clock/calendar card. Serial Pro's serial port is compatible with virtually all letter quality and dot matrix printers, including Apple's Imagewriter and Imagewriter II. The serial port can communicate with the fastest external modems at baud rates from 50 to 19,200.

Set up is easy, because unlike other cards, there are no dip switches to program or disks to use. Serial Pro has a built-in setup screen that allows all parameters to be set. And on-screen help that makes it super-easy. An on-board battery stores your selections for over 20 years, but you can change them at any time.

## SERIAL PORT FEATURES

- 5 year no hassle warranty
- Fully Super Serial Card compatible but more versatile and easier to use
- Compatible with printers
- Compatible with modems
- Prints graphics to printer (without software)
- Baud rates from 50 to 19,200
- Variable word length, number of stop bits and parity selection
- Variable handshaking, linefeed and graphics selection
- Crystal controlled circuits are used to provide ultra accurate baud rates

## CLOCK CALENDAR FEATURES

- ProDos, DOS and AppleWorks compatible. Displays time and date on the AppleWorks screen
- Automatically time and date stamps AppleWorks files
- 12/24 hour clock format
- 20 year auto recharging nickel-cadmium battery
- Switch selectable real-time interrupts
- Built-in on screen time and date setting (no software needed)
- Does not use phantom slots

Serial Pro is perfect for Apple IIe, II+, IIgs or Franklin owners in need of a serial port or clock/calendar or both. But unlike other multifunction cards on the market, Serial Pro does not use phantom slots. Other multifunction cards use phantom slots, meaning that other slots must be kept empty. Because Serial Pro doesn't use this technique, all the slots in your computer are usable.

Serial Pro comes complete with manual, cable and detailed instructions for connecting to all the leading printers and modems.

Serial Pro..... **\$139**

# TIMEMASTER H.O.™

COMPATIBLE WITH IIe, II+ and IIcs

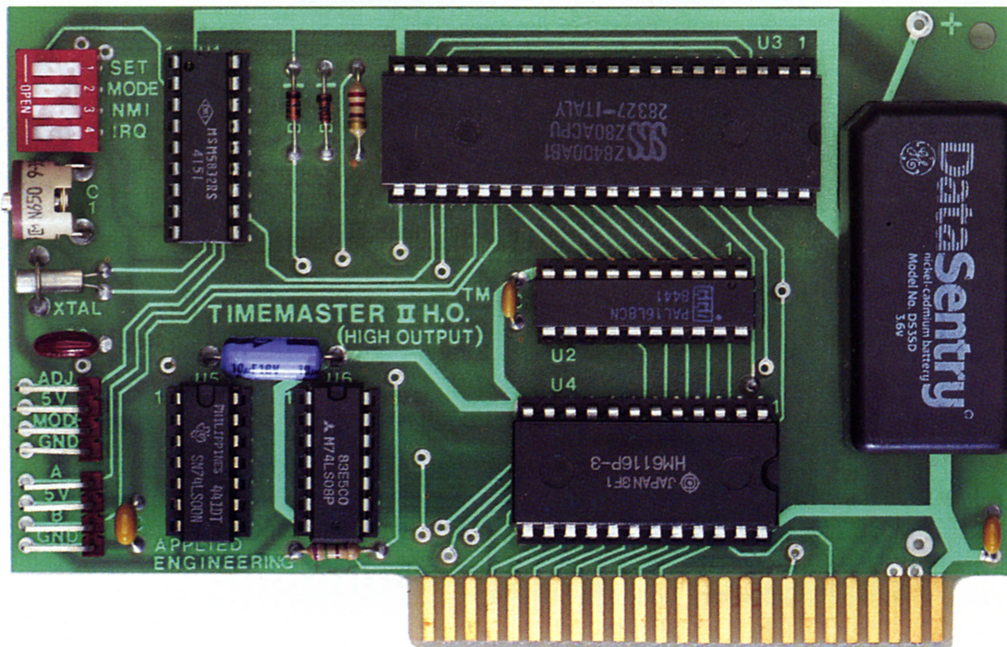

## FEATURES

- The first clock that displays the date and time on the AppleWorks screen
- Meets and surpasses all protocols as defined by Apple
- Absolutely, positively, totally ProDos and DOS 3.3 compatible
- Time in hours, minutes, seconds and milliseconds
- 24 hour military format or 12 hour with AM/PM format
- Date with year, month, day of week, and leap year (other clocks say they have the year, but they don't; it's just that ProDos will calculate the year based on day of week and it only does this for 7 years)
- The easiest programming in BASIC
- Fully buffered data buss
- Eight software controlled interrupts so you can run two programs at the same time (many examples are included)
- The only card recognized by both the DOS 3.3. and ProDos versions of AppleWriter IIe
- Compatible with ALL of Apple's languages. Sample programs for machine code, Applesoft, CP/M and Pascal on 2 disks
- On-board timer lets you time any interval up to 48 days long down to the nearest millisecond
- Accuracy 0.00005%
- High quality P.C. board, gold plated connector, all I.C.'s in high quality sockets, with mil. spec. components used throughout
- Five year no hassle warranty
- Auto Recharging nickel-cadmium battery will last over 20 years



**Timemaster H.O. is the first clock to display the date and time on the AppleWorks screen.**

*More on next page*

	<b>PRO-DOS COMPATIBLE</b>	<b>INCLUDES DOS DATER</b>	<b>MILLISECOND TIME</b>	<b>YEAR DATA</b>	<b>LARGEST SAMPLE SOFTWARE</b>	<b>REMOTE SET PORT</b>	<b>BSR PORT</b>	<b>EMULATES ALL OTHER CLOCKS</b>
<b>H.O.</b>	<b>YES</b>	<b>YES</b>	<b>YES</b>	<b>YES</b>	<b>YES</b>	<b>YES</b>	<b>YES</b>	<b>YES</b>
BRAND A	NO	NO	YES	NO	NO	NO	NO	NO
BRAND C	NO	NO	NO	NO	NO	NO	NO	NO
BRAND M	NO	NO	NO	NO	NO	NO	NO	NO
BRAND P	YES	YES	NO	YES	NO	NO	NO	NO
BRAND S	NO	NO	NO	YES	NO	NO	NO	NO
BRAND T	YES	NO	NO	NO	NO	NO	YES	NO

**H.O. — FOR THOSE WHO NEED IT, SIMPLICITY**

At first, all clock cards seem to give you about the same things. Until you put them to work. Then you'll find out if they do everything you expected. Or make you do everything the hard way or maybe they won't even do it at all.

You know what makes the difference? It's not just having the newest, whizziest features, but rather what those features actually do for you in the real world. And that's the whole idea behind the Timemaster H.O. because the H.O. is designed to work with you in a natural, intuitive way.

What we're really talking about here is useability. When you get right down to it, it's not any one big thing, but a combination of a lot of little things. Like full emulation of ALL other clocks. Yes, we emulate Brand A, Brand T, Brand P, Brand C, Brand S and Brand M too. It's easy for the H.O. to emulate other clocks, we just drop off features. That's why the H.O. can emulate others, but none of the others can emulate us.

The Timemaster H.O. will automatically emulate the correct clock card for the software you're using. You can also give the H.O. a simple command to tell it which clock to emulate. This is great for writing programs for those poor unfortunates who bought some other clock card. In fact, you could put ALL the competitive cards in every slot in your Apple and you still wouldn't have all the features of the Timemaster H.O.

Of course, most programs will use the Timemaster H.O. in its native mode, but it's comforting to know that you can use programs written for other products without any modification.

The Timemaster H.O. comes with a ton of fun and useful software. It has an easy-to-read yet detailed manual, a 20 year auto-recharging battery and a 5 year no hassle warranty.

**H.O. — FOR THOSE WHO CAN HANDLE IT, PERFORMANCE**

If you program (or are learning to), you'll find the H.O. a joy to use. A 36 page manual has many program examples. Soon you'll wonder how you ever got along without your H.O. And speaking of software, you also get 2 disks full of some really fantastic sample programs in machine code, DOS 3.3, ProDos, BASIC, PASCAL and CP/M. In fact, we provide more sample software than all the competition combined. Hobbyist take note: Most of the machine code programs come

with their source code on disk. In Pascal, the H.O. will update the filer and disks with the correct date and time. All routines are installed in the SYSTEM LIBRARY for easy use. You'll never use the Date command again! Other software includes Appointment Book so you'll never forget to do anything again. Just enter appointments up to a year in advance then forget them. Appointment Book will remind you.

As for ProDos, well, the H.O. is totally ProDos compatible. The H.O. works with ProDos software like AppleWorks, Catalyst IIe, SuperCalc 3A, Word Juggler and ALL other ProDos software. And let's get one other thing out of the way—No other clock is more compatible with ProDos than the Timemaster II H.O.; none, zero, zip.

DOS 3.3 users will appreciate our Dos-Dater software, which upgrades the DOS on your disks so that DOS 3.3 will use the H.O. to time and date (including the year) disk files. Every time a program is saved or modified, the time and date are stored in the CATALOG with the name. You can now tell when a program was saved or when any file was last modified, and this date stamping feature is completely automatic.

**REMOTE CONTROL**

Our BSR X-10 interface option for the H.O. allows you to remotely control lights and electrical appliances through your BSR X-10 home control system in your home or office. You're already wired because a BSR system sends its signals over regular 120 volt wiring. That means you can control any electrical device in your home or office without any additional wiring.

The X-10 is easy to program because it is controlled by firmware in ROM on the Timemaster H.O. One simple command will turn on or off any appliance or light (lights can be brightened or dimmed too). Use your Apple for security lighting, heating and A.C. control, lab/process control, waking up Junior, re-waking up Junior and controlling your T.V. set (just think, you need not miss another episode of Star Trek).

Is the Timemaster H.O. a simple, easy to use clock for beginners? Or a sophisticated, high performance peripheral for the experienced? The answer is "YES". And when you think about it, aren't those two products the one you need now?

- BSR Option (may be added later) ..... **\$39**
- BSR Command Console ..... **\$39**
- Timemaster H.O. .... **\$99**



COMPATIBLE WITH IIe, II+ and IIgs

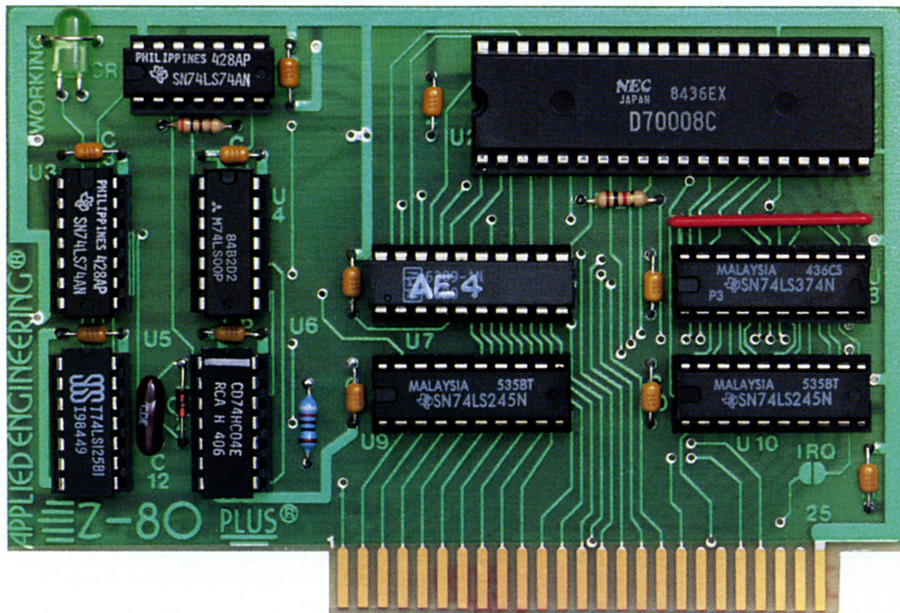

Enter the CP/M world with the new Z-80 Plus card from Applied Engineering and introduce your Apple to thousands of new programs. Only the Z-80 Plus comes standard with the new 5.1 software, the most advanced system for running Apple CP/M programs ever. Only CP/AM 5.1™ has advanced features like built-in disk emulation for popular memory expansion boards (those made by Apple and Applied Engineering and others) to give you a faster system with more storage. You also get menu driven utilities that are much easier to use than the older CP/M utilities so you can get down to all that great CP/M software faster. Each Z-80 Plus card comes complete with CP/AM manual, 5.1 operating system and advanced utilities on disk. The Z-80 Plus runs older Apple CP/M programs too, down to Version 1.6 (2.2 is the most popular). With the Z-80 Plus you can run the largest body of software in existence and the Z-80 Plus is the only card on the market capable of accessing more than 64K in an Apple IIe. If you have RamWorks, up to 3072K is available to CP/AM as a RAMdisk; with RamFactor, up to 1024K. And each Z-80 Plus includes our CP/AM RamDrive software, enabling IIe owners to use an extended 80 column card, or a RamWorks card as an ultra-fast RAM disk enabling CP/M software to run 10 to 20 times faster. So fast acting software like WordStar and dBASE II become virtually instantaneous.

You'll have two computers in one and the advantages of both, all at an unbelievably low price.

**FEATURES**

- Totally compatible with all CP/M software
- Fully compatible with Microsoft disks (no pre-boot required as with others)
- Executes the full Z-80, 8080 and 8085 instruction set

- Does everything the other Z-80 cards do plus supports Z-80 interrupts
- Specifically designed for High speed operation in the Apple IIe and IIgs (runs nearly as fast in the II+ and Franklin)
- Green "CP/M Working" LED indicator, the Z-80 Plus does not interfere with non-CP/M programs
- An on-card ROM eliminates many I.C.'s for a cooler, less power consuming board
- Compatible with 5¼" and 3½" disk drives as well as the Sider hard disk and most other popular hard disks
- The Z-80 Plus can access up to 3072K of RAMdisk memory (most programs only need 64K)
- Runs on any Apple II, II+, IIe or IIgs with at least 64K memory. Works with any 80 column card, but does not require one
- The Z-80 Plus will allow you to run: dBASE II, WordStar, Spell Star, Turbo Pascal, Cobol-80, Fortran-80, Peachtree and ALL other Apple CP/M based software
- Fast Clock: 2 MHZ (Z-80B)
- Documentation included
- High quality P.C. board, gold plated connector, all I.C.'s in high quality sockets, with mil. spec. components used throughout
- Compatible with Apple II, II+, IIe and IIgs
- 5 year no hassle warranty

With the Z-80 Plus, you can access the largest body of software in existence. Two computers in one and the advantages of both, all at an unbelievably low price.



and C.O.D. 214/241-6060

**\$149**



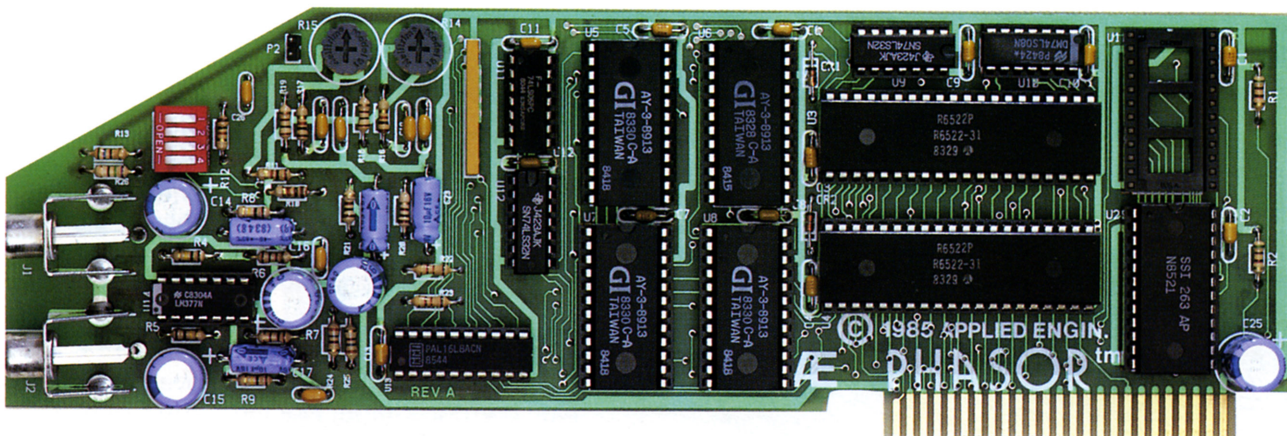

**PHASOR - For the thunderous, booming power you so desperately need**

Phasor is a complete high performance stereo music, sound and speech synthesizer for the Apple IIe, II+ or IIgs. Phasor offers 12 musical and sound effects voices (channels) and 4 white noise generators for percussive sounds. Phasor also gives your Apple the power of uncanny speech, with its unlimited vocabulary speech synthesizer.

What makes Phasor so desirable is not just that it offers the very best in both sound and speech, but the fact that Phasor automatically enhances and is recognized by more off the shelf hardware than any other sound card. Phasor works with ANY program that works with ANY sound card. Programs written for the Mockingboard™, the ALF music card, Synphonix™ and the Super Music Synthesizer actually sound better on Phasor. In fact, Phasor has twice the accuracy and 4 times the output power of the nearest competitor. Phasor adds exciting pulse pounding sound to all of the better games like Skyfox, Under Fire, Willy Byte, Tactical Armor Command, Maze Craze, Zaxxon, Ultima IV; to name a few. Educational software like Music Construction Set, Guitar Master and Music Star are greatly enhanced by Phasor's power. And a complete long list of compatible software is included with each Phasor.

But even if you don't own any software, Phasor comes with a ton of entering and educational software that will let you enjoy Phasor for a long, long time.

Phasor is an astonishing peripheral card that generates explosive sound effects, vibrant music and excellent speech from your Apple. It adds a new educational dimension of exciting sounds to games, educational programs, music programs and programs you create yourself.

**FEATURES**

- The most compatible sound card available. Fully Mockingboard™, ALF, and Super Music Synthesizer compatible but with many enhanced capabilities.

- 12 simultaneous sound channels, 4 white noise generators, 1 voice channel expandable to 2 voices.
- Easy to use "COMPOSE" software. You'll start right away at inputting your favorite songs. Our manual shows you how, step by step. The Hi-Res screen shows what you've entered in standard sheet music format.
- Included Software: Music Editor, Sound Effects Editor, Text to Speech, and over 30 songs and sound effects ready to run, not copy protected! ProDos based.
- Easy to program in Basic to generate speech and complex sound effects. Now your games can have explosions, phasor zaps, train whistles, death cries. You name it, this card can do it.
- Unlimited vocabulary voice.
- Simple commands adjust rate of speech, pitch, volume and more.
- Powerful 4 watt stereo amplifier for direct connection to any size speakers.
- Requires Apple IIe or II+ (64K minimum) with one disk drive.
- Software is RAM based when used with any standard RAM card for ultra-fast operation.
- No hassle 5 year warranty.

**WARNING:** Applied Engineering will not be responsible for shattered windows, cracks in plaster, or government personnel mistakenly thinking an alien attack is taking place in your neighborhood. Phasor is equipped with volume controls. Please keep them at the appropriate level. Thank you.

**\$179**

**COMPATIBLE WITH IIc**

Z-RAM Ultra fits neatly inside any IIc, new or old. Installation is easy, clear instructions show you how. You'll need a screwdriver and about 20 minutes.

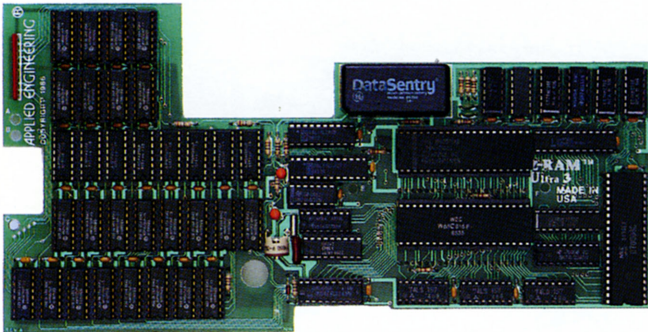

**Z-RAM Ultra 3:**

Memory to 1 MEG, Clock and CP/M

256K **\$329**      512K **\$379**      1 MEG **\$459**

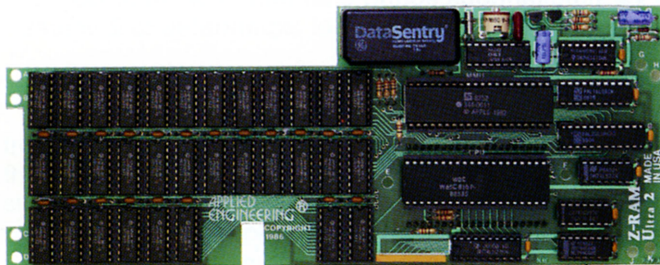

**Z-RAM Ultra 2:**

Memory to 1 MEG, Clock

256K **\$269**      512K **\$319**      1 MEG **\$399**

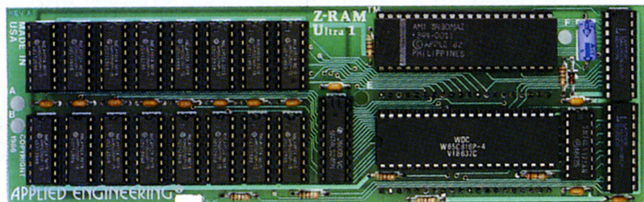

**Z-RAM Ultra 1:**

Memory to 512K

256K **\$199**      512K **\$249**

Your Apple can become a computer you never dreamed it could be. Because the most exciting chapter in the Z-RAM history of turbo charged IIc's has just been written. It's called Z-RAM Ultra. And it takes IIc expansion into a whole new realm.

**The AppleWorks Amplifier**

With any Z-RAM Ultra, your AppleWorks word processor capacity will instantly increase from 2,250 lines to over 23,000 and the maximum number of records from 1,350 to over 23,000. Available desktop memory rockets to over 700K with *all* of AppleWorks loaded into RAM. Z-RAM Ultra even expands the clipboard and auto segments large files so they can be saved on two or more disks. AppleWorks will now run about 10 times faster in your IIc with one disk

drive than in other IIc's with two disk drives. Nothing else comes close to enhancing AppleWorks like this!

Z-RAM is also a high speed solid state disk drive. With Z-RAM your programs will load and save over 20 times faster. Z-RAM's RAM disk is compatible with AppleSoft, ProDos, DOS 3.3, PASCAL and CP/M. And with Z-RAM you can copy a disk in one pass. Just insert the original, remove the original, insert blank disk! That's it! Z-RAM is another disk drive, only 20 times faster, 4 times larger capacity, and no whirring, clicking or waiting!

**Only with Ultra 3**

But before you start panting over all that extra memory, don't forget that the Z-RAM Ultra 3 card has a built-in high speed Z-80 microprocessor that allows you to run CP/M programs like Wordstar, dBASE II, Turbo PASCAL, Microsoft BASIC, FORTRAN and COBOL and over 5,000 other CP/M programs. So Z-RAM Ultra 3 not only makes Apple programs run better and faster, it lets you run MORE programs.

**Only with Ultra 2 or Ultra 3**

A built-in real-time clock. Displays the time and data on AppleWorks screens and files, and is fully ProDos compatible.

With the Z-RAM Ultra card installed, your IIc is still your IIc only now you'll have that extra memory that AppleWorks and other programs need.

**FEATURES**

- Works in any IIc, new or old
- Up to 1 MEG memory (you choose how much) lets you store, load and run programs up to 20 times faster
- Expands and accelerates all memory intensive programs, including AppleWorks
- No jumper wires, clips or drive removal—so installation takes only a few minutes and a screwdriver
- Optional 65C816 16-bit processor plugs right in with no component changes
- Printer buffer lets you continue working while printing AppleWorks files
- Real-time clock displays time and date on AppleWorks screens and files, and is ProDos compatible for use with other ProDos software
- Run CP/M programs with Z-RAM Ultra's built-in Z-80B microprocessor

Z-RAM is 100% compatible with all IIc software and hardware including the mouse, second disk, modem and printer. Z-RAM is easily handled by the IIc power supply as power consumption is kept very low by using custom integrated circuits and a patent pending power saving design.

Z-RAM comes complete with manual and software, and a 5 year no hassle warranty.

**Pinpoint's AppleWorks Accessories with Ram Enhancement Software for 128K Enhanced IIe/IIc**  
 Together a \$118 value. .... **\$79**

16-bit 65C816 Upgrade ..... **\$99**

## Z-80c

COMPATIBLE WITH IIc

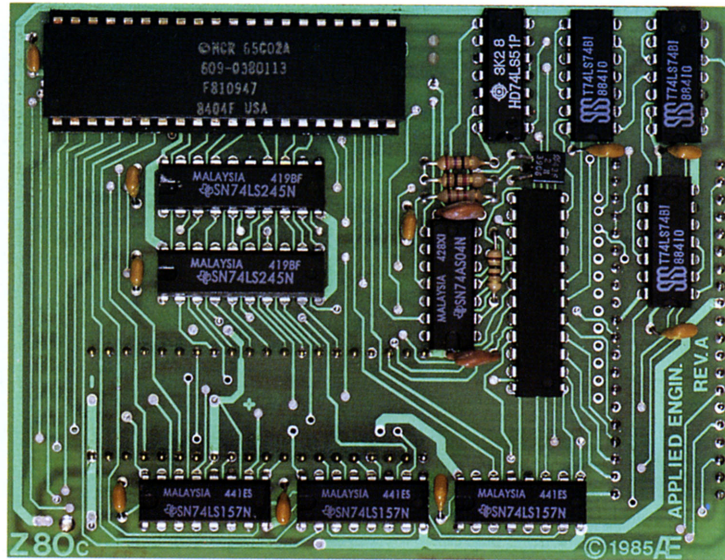

Apple IIc owners can now run the single largest body of software in existence. Enter the CP/M world with the new Z-80c and introduce your IIc to thousands of new programs. With the Z-80c, you'll be able to run Wordstar, dBase II, Turbo Pascal and thousands of other programs that require CP/M. But your IIc will still be your IIc because the Z-80c only turns on when using a CP/M disk.

The Z-80c comes standard with the new 5.1 software, the most advanced system for running Apple CP/M programs ever. But it also runs other versions of CP/M including the popular 2.2 and 2.23 and is fully compatible with Microsoft disks with no pre-boot.

But naturally you'd expect top performance from the Z-80c. After all, it's from Applied Engineering and we've got years of experience with Z-80 cards for the II+ and IIe.

The Z-80c can use all 128K in the IIc, or 64K can be reserved as a RAM disk.

The Z-80c fits neatly inside the IIc. Installation is easy and only takes about 10 minutes (it just plugs in). After installation, your IIc will act and look just like other IIc's, only now you can run all that great Apple CP/M software that others can only dream about.

The Z-80c comes complete with Z-80 card, 5.1 operating system, utility disk, a plain English owners manual and a 5 YEAR WARRANTY. And although the Z-80c is the only CP/M interface on the market for the IIc, we've priced it as though the competition was fierce.

When you consider the fact that many people spend 2 or 3 thousand dollars on a CP/M only computer, our price of \$159 is an offer that's practically irresistible.

### FEATURES

- Totally compatible with all Apple CP/M software
- Executes the full Z-80, 8080 and 8085 instruction set
- Fully compatible with Microsoft disks (no pre-boot required as with others)
- Specifically designed for High Speed Operation in the Apple IIc
- An on-card ROM eliminates many I.C.'s for a cooler, less power consuming board
- A semi-custom I.C. and a low parts count allows the Z-80 to fly through CP/M programs at a very low power level
- The Z-80 will allow you to run: dBase II, WordStar, SpellStar, Turbo Pascal, Cobol-80, Fortran 80, Peachtree and all other Apple CP/M based software
- Fast clock: 2 MHZ (Z-80B)
- Documentation included
- High quality P.C. board, gold-plated connector, with mil. spec. components used throughout
- 5 year no hassle warranty

The Z-80c will give you two computers in one and the advantages of both, all at an unbelievably low price.

**\$159**



and C.O.D. 214/241-6060

## 12 BIT, 16 CHANNEL A/D

COMPATIBLE WITH IIe, II+ and IIgs

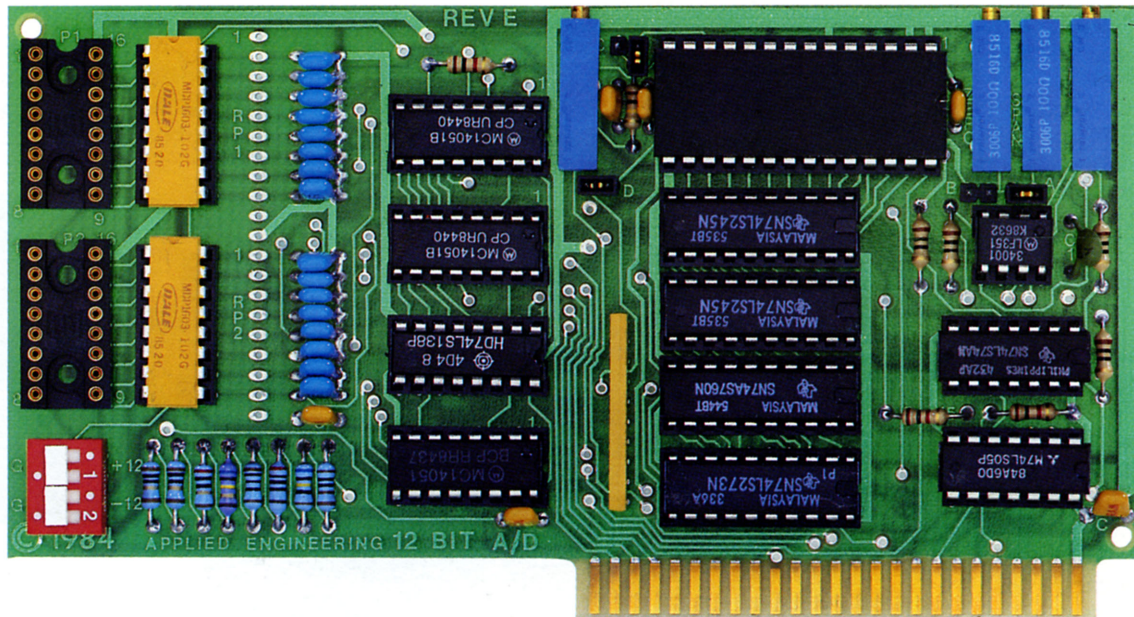

### FEATURES

- Design incorporates the latest in state-of-the-art I.C. technologies
- Complete 12 bit A/D converter with an accuracy of 0.03%
- 16 input channels
- 9 software programmable full scale ranges, any of the 16 channels can have any range at any time. Under program control, you can select any of the following ranges:  $\pm 10$  volts,  $\pm 5$ V,  $\pm 2.5$ V,  $\pm 1.0$ V,  $\pm 500$ mV,  $\pm 250$ mV,  $\pm 100$ mV,  $\pm 50$ mV, or  $\pm 25$ mV
- Very fast conversion (25 micro seconds)
- Analog input resistance greater than 1,000,000 ohms
- LASER-trimmed scaling resistors
- Low power consumption through the user of CMOS devices
- The user connector has +12 and -12 volts on it so you can power your sensors
- Works in any slot including slot 3 in the IIe

- Only elementary programming is required to use the A/D
- Input filtering for all 16 channels can filter out any frequency over a value you select, from 2HZ to 100,000 KHZ
- The entire system is on one standard size plug in card that fits neatly inside the Apple
- Systems include several sample programs on disk for BASIC and machine code including source code
- Works in any slot of a IIe or II+ including slot 3 of a IIe

Our latest A/D card features true 12 bit resolution and data acquisition rates of up to 40,000 samples per second, 16 input channels and 9 software programmable gains. The AE 12 bit A/D easily out performs the competition.

A few applications may include the monitoring of flow, temperature, humidity, wind speed, wind direction, light intensity, pressure, RPM, soil moisture, and many more.

**\$279**

## SIGNAL CONDITIONER

COMPATIBLE WITH IIe, II+ and IIgs

Our 8 channel signal conditioner is designed for use with our A/D converter. This board incorporates 8 F.E.T. op-amps, which allow almost any gain or offset. For example: an input signal that varies from 2.00 to 2.15 volts or a signal that varies from 0 to 50 mV can easily be converted to 0-10V output for the A/D.

The signal conditioner's outputs are on a high quality 16 pin gold I.C. socket that matches the one on the A/D so a simple ribbon cable connects the two. The signal conditioner can be powered by your Apple or from an external supply.

### FEATURES

- 4.5" square for standard card cage and 4 mounting

holes for standard mounting

- 22 pin .156 spacing edge card input connector (extra connectors are easily available i.e. Radio Shack)
- Large bread board area
- Uses F.E.T. op-amps for an input impedance of 10,000,000,000 ohms
- Full detailed schematic included
- All gains and offsets are programmed with easily constructed plug in component platforms (Two blank platforms included)

**\$79**



and C.O.D. 214/241-6060

**COMPATIBLE WITH IIe, II+ and IIgs**

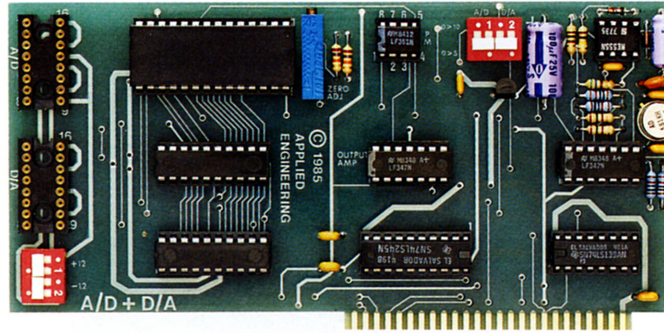

Commercial, industrial, and scientific data acquisition and control functions are now practical with Applied Engineering's A/D + D/A card.

**A/D + D/A FEATURES**

- Single PC card
- 8 channels A/D
- 8 channels D/A
- Superfast conversion time
- Very easy programming
- Many analog ranges
- Manual contains sample applications
- Works in any slot of a IIe or II+ including slot 3 of a IIe

**A/D SPECIFICATIONS**

- 8 channels
- 0.3% accuracy
- On board memory
- Fast conversion (.078 mS per channel)
- A/D process totally transparent to Apple (looks like memory)
- Eliminates the need to wait for A/D conversion (just peek at data)
- No missing codes over full temperature range
- 50K ohms analog input resistance
- User programmable input ranges are 0 to 10 volts, 0 to 5, -5 to +5, -2.5 to +2.5, -5 to 0, and -10 to 0

The A/D section is an 8 bit, 8 channel memory buffered, data-acquisition system on a single Apple plug-in card. It consists of a high speed 8 bit successive approximation A/D converter, an 8 channel multiplexer, 8X8 dual-port RAM, and all necessary

control logic. The A/D process takes place on a continuous, channel sequencing basis. Data is automatically transferred to its proper location in the on board RAM. No A/D converter could be easier to use.

**D/A SPECIFICATIONS**

- 8 channels
- 0.3% accuracy
- On board memory
- On board output buffer amps can drive 5 MA of output current
- No missing codes over full temperature range
- D/A process is totally transparent to the Apple (just poke the data)
- Fast conversion (.003 mS per channel)
- User programmable output ranges are 0 to 5 volts and 0 to 10 volts

The D/A section contains 8, 8 bit voltage output, digital to analog converters, with output buffer amplifiers and all interface logic on a single card. No trims are required to achieve the full specified performance. Separate on-card latches are provided for each of the eight D/A converters. No D/A converter could be easier to use. The on board amplifiers are LASER-trimmed during manufacture, thereby eliminating any requirement for offset nulling.

A few applications may include the measurement and control of temperature, humidity, wind speed, wind direction, light intensity, pressure, RPM, soil moisture, process control, automatic test equipment and many more.

**\$199**

**I/O 32**

**COMPATIBLE WITH IIe, II+ and IIgs**

**FEATURES**

- Provides 4, 8-bit programmable I/O ports
- Any of the 4 ports can be programmed as an input or an output port
- All I/O lines are TTL (0-5 volt) compatible
- Your inputs can be anything from high speed logic to simple switches
- Programming is made very easy by powerful on-board firmware
- The I/O 32 is your best choice for any control application
- Manual includes many programs for inputs and outputs

**Some applications include:**

Burglar alarm, direction sensing, use with relays to turn on lights, sound buzzers, start motors, control tape recorders and printers, use with digital joystick.

The I/O 32 features twin 6821 PIAs (Programmable Interface Adaptors). However, unlike previous offerings from other companies, the I/O 32 has its own powerful on-board firmware. This on-board firmware makes your programming a snap from BASIC. Of course, if you want to control the I/O 32 directly you can.

So whether you're a beginning BASIC programmer or an expert at machine language programming, the I/O 32 is the perfect solution to any control application.

**\$89**

## HEAVY DUTY POWER SUPPLY

COMPATIBLE WITH IIe and II+



With today's advanced peripherals it's easy to overload the standard Apple power supply. Applied Engineering now offers a heavy duty 6000 MA Power Supply to fill the needs of today's power user.

The standard Apple power supply is rated at only 2500 MA. Use the chart below by adding up the peripherals in your Apple to determine if your system is overloaded.

DEVICE	MA's (apx)
Apple IIe (only) .....	1000
Apple II+ (only).....	1500
5¼" disk interface .....	400
3½" disk interface .....	500
Hard disk interface .....	700
Typ. 1 MEG Ram Card .....	1100
1 MEG RamWorks III.....	400
Accelerator .....	500
Clock card .....	200
CP/M card .....	300 - 1000

Modem.....	400 - 900
Printer interface .....	300 - 600

As you can see, it's easy to exceed the 2500 MA's that Apple's power supply can deliver. With Applied Engineering's heavy duty Power Supply you'll have over 6000 MA's available for even fully loaded Apples.

### SPECIFICATIONS

- Same size as Apple's power supply using same 4 mounting holes
- Input voltage: 90 to 135 VAC / 60 Hz or switchable to 180 to 270 VAC / 50 Hz
- High efficiency switching type design
- Output: +5V @ 6000MA, +12V @ 2500MA, -12V @ 1000MA, -5V @ 1000MA
- Ripple: 10MV typ.
- Full load operating temperature: 32° to 122° F (0° to 50° C)
- Full 1 year warranty

**\$69**

## 5¼" HALF HEIGHT DISK DRIVE

APPLE COMPATIBLE

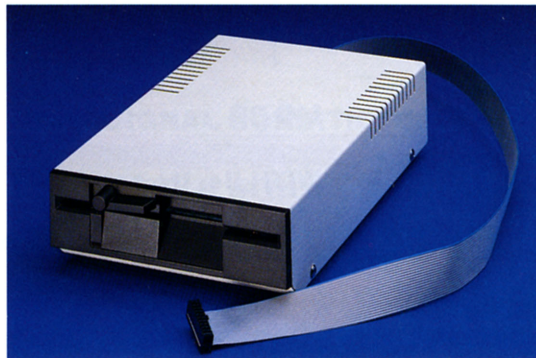

- Fully compatible with all Apple software
- Compatible with IIe, II+ and IIgs
- Special pulse motor makes it accurate, reliable and fast
- Works with the Apple disk II controller card or other compatibles (each controller card handles 2 drives)
- 143K formatted, 35 tracks, 16 sector
- Super quiet

- Full 1 year warranty
- Complete with 24" long cable that plugs directly into your controller card **\$139**
- Disk controller card available if needed; handles 2 disk drives. Compatible with IIe, II+ and IIgs **\$59**
- IIc adapter cable, adapts standard Apple drives for use with Apple IIc & a IIgs daisy chained drive **\$19**



# ORDER FORM

SEND ORDERS TO OUR ADDRESS  
OR CALL (214) 241-6060

**AE**  
**APPLIED ENGINEERING**  
P. O. BOX 798  
CARROLLTON, TX. 75006

**SOLD TO:**

NAME \_\_\_\_\_  
ADDRESS \_\_\_\_\_  
CITY \_\_\_\_\_  
STATE \_\_\_\_\_ ZIP \_\_\_\_\_

**SHIP TO:**

NAME \_\_\_\_\_  
ADDRESS \_\_\_\_\_  
CITY \_\_\_\_\_  
STATE \_\_\_\_\_ ZIP \_\_\_\_\_

**METHOD OF PAYMENT:**

CHECK



MASTERCARD



VISA

COD

TELEPHONE NUMBER: \_\_\_\_\_

CREDIT CARD NUMBER: 

--	--	--	--	--	--	--	--	--	--	--	--	--	--	--	--	--

EXPIRATION DATE: \_\_\_\_\_ SIGNATURE: \_\_\_\_\_  
(as on card)

<b>QTY</b>	<b>UNIT PRICE</b>	<b>DESCRIPTION</b>	<b>TOTAL PRICE</b>
		<b>SUBTOTAL</b>	
		TEXAS RESIDENTS ADD 6¼% SALES TAX	
		<b>TOTAL</b>	

**Add \$3 for shipping in the U.S., \$5 to  
Canada, \$10 outside U.S.**



"I've purchased several Applied Engineering products over the years.  
They're always well made and performed as advertised.  
I recommend them whole-heartedly!"

—STEVE WOZNIAK  
*Apple Inventor and  
Co-Founder*

**AE**  
**APPLIED ENGINEERING**  
**"WE SET THE STANDARD"**  
**214/241-6060**