

Might and Magic[®] II

Gates to Another World

**A Fantasy Role-Playing Simulation
By Jon Van Caneghem**

NEW WORLD COMPUTING, INC.
ENTERTAINMENT SOFTWARE

©1988 NEW WORLD COMPUTING, INC.

FIRST EDITION

The enclosed software program and this book are copyrighted. All rights are reserved. This book may not be copied, photographed, reproduced, or translated or reduced to any electrical medium or machine-readable form, in whole or in part, without prior written consent from New World Computing, Inc. Portions of the program accompanying this book may be copied, by the original purchaser only, as necessary for use on the computer for which it was purchased.

CREDITS

Designed and Created by: Jon and Michaela Van Caneghem

Programming: Jon Van Caneghem, Stephen L. Cox, Mark Caldwell

Computer Graphics: Avril Harisson and Jeff Griffieath

Manual Illustrations: Ken Mayfield

Map Illustration: Jim Krogel

Art Coordinator: Vincent DeQuattro, Jr.

Manual: Mark Caldwell and Michaela Van Caneghem

Introduction and Various Special Events: Nicholas Beliaeff

Design Studio: Focus On Design

Special thanks to the New World Computing staff and everyone else who made this project possible.

90-DAY LIMITED WARRANTY

New World Computing, Inc. warrants the original diskette on which this program is recorded to be free from defects in materials and workmanship under normal use and service for a period of ninety (90) days from the date of purchase. If such a defect should occur during this 90-day period, you may return the diskette to New World Computing, Inc. for a free replacement diskette. After 90 days, enclose \$5.00 to cover costs of media replacement and shipping charges.

This warranty is only effective if you have previously returned the Product Registration Card for this program or include a copy of your receipt for the program.

NEW WORLD COMPUTING, INC. MAKES NO WARRANTIES, EITHER EXPRESS OR IMPLIED, WITH RESPECT TO THIS MANUAL OR WITH RESPECT TO THE SOFTWARE DESCRIBED IN THIS MANUAL, ITS QUALITY, PERFORMANCE, MERCHANTABILITY OR FITNESS FOR ANY PARTICULAR PURPOSE. NEW WORLD COMPUTING, INC. SHALL NOT BE LIABLE FOR ANY LOSS OR DAMAGE, DIRECT OR INDIRECT (INCLUDING BUT NOT LIMITED TO ANY INTERRUPTION OF SERVICE, LOSS OF BUSINESS AND ANTICIPATORY PROFITS OR CONSEQUENTIAL DAMAGES), RESULTING FROM THE USE OR OPERATION OF THIS PRODUCT. (SOME STATES DO NOT ALLOW THESE EXCLUSIONS, SO THEY MAY NOT APPLY TO YOU.)

New World Computing, Inc., P.O. Box 2068, Van Nuys, CA 91404

Prologue

An account of Corak the Mysterious' unsettling disappearance as told by his apprentice, Gwyndon the Young:

Corak has always held many dire secrets, but recently he had shown signs of being outwardly distressed. This troubled me greatly as what could disturb one so powerful and composed as Corak the Mysterious? Was he not only High Priest as well as being regarded by all as a most accomplished warrior and being the most powerful Archmage other than King Kalohn the Vanquished? He was all that the knowledgeable strive to be and what the ignorant claim to be.

Corak used to tell me stories of different, wondrous worlds with hideous monsters and mighty warriors. He once even mentioned that he came from another world. I thought his stories mere fables or myths meant to entertain me. Little did I know that he spoke the truth and that a problem would arise from this truth that would drive him mad.

One day while I was working on translations of a sorcerous scroll, Corak burst into the library with a harried look on his brow. He told me of an alien criminal from another reality who had escaped into our beloved CRON! Corak then promptly forgot that I was present and proceeded to curse and mumble profusely as he searched through the books for some lost text which contained a gleaming of information which might help him expel the dangerous alien. Being insatiably curious, I attempted to eavesdrop on the conversation he was having with himself. He spoke of CRON being out of alignment with other worlds, of a highly destructive alien being named Sheltem, and of an anointed champion who could realign CRON before a horrific wave of fiery destruction would sweep across and destroy the land.

After his foray in the library, Corak acted quite strangely during the next few days. He would lock himself up in his private study for hours at a time. Frightful noises emanated from behind the locked door and then, suddenly, they would stop. He would emerge changed each time in some subtle fashion. He would enter the study after devouring almost an entire banquet by himself and exit with an appetite as if he had not eaten in days. Other times he would be wan and pale from long hours of intensive research done in the library. He would then go to the study and exit in a few hours with a tan as if he had just returned from Murray's Resort Isle, basking in the sun there for a week.

This weird behavior continued for almost a fortnight. One day, he left his study after an unusually long session and immediately started screaming about the end of the world and how he could not stop it. Amazingly, he was covered in snow and yet it was mid-summer! He then looked about in desperation and withdrew a strange, four-taloned claw which I had never even seen before. Corak then uttered a spell which caused a blinding glow of sheer power to envelope his body. He was terrible to behold, bathed in an eerie shower of what must of been pure ethereal energy, just standing there, exalting in his newfound might.

Seconds later, a clap of thunder shook the building and Corak was gone. I believe that he transported himself away in order to try to stop the mystifying doom which lay upon CRON. Unfortunately, I have my doubts. Maybe the spell of power was too much for Corak the Mysterious and he brought about his own destruction. I do not know anything for sure. After all, I am now only an apprentice without a master to tell me if I am right or wrong.

A week later, Lord Pinehurst visited and went into Corak's study. The strange, eerie noises started again and Lord Pinehurst was gone. I entered the study and noticed that one of Corak's machines was missing. Next day I received a sealed letter delivered by special courier from Lord Pinehurst. He wrote that he was fine, not to worry and that I should travel to Castle Pinehurst to continue my studies. I go now and hope that this growing chaos in my life will soon end.



History of CRON

This being a synopsis of the histories of CRON as gathered by Corak the Mysterious and found in his study in the Luxus Palace Royale by Gwyndon the Young:

I, Corak, called the Mysterious, have gathered these histories of the world aptly called CRON through personal experiences gained by the use of a magical artifact which allows travel through the very fabric of time itself.

At first, there was only void. Yet, in the nothing something arose. An ethereal substance capable of supporting life came into existence. From the time of this forming shall I, as do all in CRON, reckon time. The shaping of this etherealness took well-nigh one century to occur and develop into recognizable form.

Next, water in vast amounts came from disorder and remained to mix with the ether. Strange beings arose out of this chaotic union. Elemental lords of great power warred for control of the waters. The greatest of these was powerful Acwalandar, mightiest and most majestic of all the Water Kings. Preternatural fierceness combined with uncanny intelligence allowed him to hold unquestionable dominion over all of the other elementals. He reigned supreme for three score and a generation of years, then turmoil erupted.

Potent creatures from an unknown, mystical land charged into CRON with conquest of the brutal Water Lords as their goal. A battle which would last centuries began. Acwalandar and his minions were taken by surprise and the strange beings gained a foothold which they would not release. Puzzlement and fear of the unknown swept through the ranks of the normally stolid water elementals. Who were these warriors who suddenly came from nowhere? They were Spirits of the Air come from afar to expand their empire. Their lord was terrible indeed, a creature of tumultuous air named Shalwend who could call upon tremendous legions of vicious air elementals to blow back the shocked Water Lords. Air fought with Water for over a century, until reaching a level of equilibrium which neither side could change.

Seeking to upset the deadlock and gain the momentum in the war against the air elementals, Acwalandar charged his servitors to create an ultimate weapon. He received much more than he wanted. His vassals summoned forth incredibly powerful creatures of destruction that would remain under the Water Lords total dominance. Fire elementals were issued forth. These hateful monsters sole purpose in life was to destroy, and at destruction their like will never be approached. They sucked the life out of the Air Spirits without mercy, forcing them to endure a slow, consuming burn until there was nothing left. However, the Fire Lords were few in number and could not totally destroy the Masters of the Wind.

The leader of the burning horde, Pyrannaste, Master of Flame, disliked the iron-fisted rule of Acwalandar and the Water Lords. Any hesitation of a fire elemental in carrying out an order issued by a Water Lord would result in extinguishment. Pyrannaste waited, for he was patient, and even though he and his vassals chafed under the rule of the water elementals they hated Shalwend and the air elementals even more.

Eighty years of servitude and war passed for the Fire Lords until Pyrannaste deemed the time proper for rebellion against Acwalandar. Wanting only to escape servitude while still being able to crush the ranks of the despised Shalwend, the Master of Flame attempted to break away peacefully from the air elementals. At first they succeeded, but resentment and overconfidence built up in the Legions of Water. Are not the fire elementals our servants, brought forth by us to serve our needs? Can we not crush them as we crushed the Masters of the Winds? This the armies of Acwalandar thought, forgetting that the might of the air horde must be fought once again without aid. Also forgetting that in order to extinguish a fire elemental, a Water Lord loses much of himself in the struggle that ensues.

Shrewd Acwalandar realized that the Water Lords could not hope to end victorious in a war against both the air and the fire elementals. However, his counsel fell upon deaf ears. What good is the voice of reason to an angry mob? For fifty years Water fought Air and Fire, Fire fought Water and Air, and Air fought Fire and Water. Battles were bloodthirsty and allies were nonexistent. CRON had transformed into a chaotic battlefield with no one group able to assert itself over the others.

And then came disaster. From places vaguely rumored to exist came the most fearsome creatures yet. Emperors of Earth they called themselves. They were led by Gralkor the Cruel. In one fell stroke they invaded CRON and caused the petty struggles between Water, Air, and Fire to come to an utter halt. Ancient enemies were forced to unite for survival against the new, common enemy. At first, the earth elementals appeared invulnerable. Eighty years and innumerable battles later, a method was found to stop them. Acwalandar and the Water Lords would soak the earth elementals with a flood of water. Then, Pyrannaste and the Fire Lords would bake the dissipated creatures into dry silt. Finally, Shalwend and the Air Spirits would lift the silt into the sky and spread all of the particles across the world, leaving the earth elemental utterly eradicated.

Alas, the effort by the three elemental tribes was too late to stop Gralkor the Cruel and the Emperors of Earth. They had pooled together and formed a giant mass of earthen matter which floated upon water, was immune to fire, and which would not scatter as leaves upon the wind. For twenty more years the elementals attempted to overcome the earthen landmass of Gralkor the Cruel. They failed miserably and the Emperors of Earth assumed command of what would become CRON.

By the year 500, Gralkor and the earth elementals were busily constructing a fixed land area with the toil of their slaves. For almost one hundred years all of the elementals, Water, Air, Fire, and Earth, struggled to perfect the landmass. What they came up with is what we know as the physical land of CRON.

Rumor of CRON spread to other worlds somehow and an inexorable flow, of what were to the elementals, small, pitiful creatures began to populate the work of Gralkor in the seventh century. The creatures were of many different humanoid types, but they all had basic similarities and resistances which enabled them to survive in CRON. Water beaded off them, air swirled past them, fire did burn them, but only under extremes, and mighty earth they trod upon. The humanoids were able to extract properties from each of the four element's features and use it for their own benefit. But perhaps most

important of all, they could weave magic. At first, there were few of these pathetic creatures, but they multiplied rapidly and spread across the landmass. The humanoids strengthened after years of toil and pain. Ambitions grew and they attempted to make CRON their own. This aroused the attention of Gralkor the Cruel and forced him into action.

Unfortunately for the elementals, Gralkor acted too late. The humanoids had been in CRON for over seventy years and had acclimated themselves to all the difficulties which the elementals could produce. They had weapons and spells which could immobilize all but the most powerful elemental lords. Gralkor did not realize this and made a most fatal error, he attacked. He marshalled his forces for the obliteration of the feeble humanoids. The humanoids knew what to expect and lay a trap for the elemental forces.

All of the most powerful spell-casters gathered on the Isle of the Ancients and combined their efforts to create an orb of power. This orb had a mystic receptacle, a four taloned claw. There was a talon for each elemental force and alone, that talon could control the elemental creatures it represented. The four talons could be combined to form a holder for the orb. This formed a weapon of incomparable power which could guarantee the complete submission or destruction of any and all elemental creatures. Many tests were made in order to perfect this weapon. Gross mutilations and horrible deaths were the results of most of these. In the latter part of the eighth century there was a human male weak in magic but strong in courage named Kalohn who tested the orb and survived unmolested. Many humanoids died before this because of Gralkor's attack and the testing of the orb. Kalohn resolved to end it all immediately.

He went to the tallest mountain in all of CRON alone. He then challenged the four elemental lords to do battle. Much damage to the land followed, including the transformation of the mountain into the crater we know as The Dead Zone. Kalohn, armed with the orange, glowing orb emerged victorious and then banished each of the four elemental tribes to a separate corner of CRON and formed barriers to keep them imprisoned. Within each elemental zone he placed the corresponding talon of the mighty claw in the order of the elementals' appearance, water, air, fire, and earth. He kept the orb for himself.

With the elemental forces banished from direct interaction with the humanoids of CRON, civilization evolved and everyone prospered. Kalohn gained much magic power due to his battle with the elementals and his frequent use of the orb. He became King Kalohn the Conjuror and ruled wisely for thirty or more years. Peace spread throughout the land. Education began of the young and living conditions improved. Communities formed and trade developed. People were happy and content.

Then in the mid ninth century, the elementals struck back. Unable to physically enter CRON and maddened at the elementals' defeat at the hands of a single, puny human, Acwalandar studied that which defeated him, magic. He had a great aptitude for sorcery and learned quickly by studying the humanoids who ventured near his realm. He gained particular skill in forming and summoning. Using this skill, Acwalandar formed a fell creature of enormous girth and power. He filled it with life from many of his followers and endowed it with the most fearsome of weapons known to him, fire. He had created the first dragon, a creature of mindless destruction and incredible strength. This dragon was formed just outside of the water barrier and left Acwalandar with the intent to destroy Kalohn and then CRON.

King Kalohn the Conjuror sensed the dragon's creation and the threat it posed. He sought it out to vanquish it and quell the elemental lords forever. He met the dark creature in the beautiful Savannah of Plenty. Unfortunately, mighty as he was, Kalohn had only the power of the now faintly glowing orb with him and perished after a disappointingly quick battle. The dragon breathed barrels of flame and engulfed Kalohn entirely, consuming him in a bath of fiery death. Kalohn had attempted to cast a spell which would form a shield of water to protect himself, but the spell was changed as a last minute surge of power from the orb went through Kalohn's body and caused a flood to ravage the Savannah. For all the might of the dragon, he could not fly without wings and was too heavy to swim. He died a slow death, powerless against the natural habitat of his master.

Aftereffects of the battle were numerous and disastrous. The Savannah of Plenty was destroyed and became the Quagmire of Doom, an area of great evil. However, it is rumored that the orb still exists somewhere in the Quagmire, though no one has ever found it. Dragons entered CRON through once closed corridors and wreaked havoc among the populace. Princess Lamanda, Kalohn's daughter, assumed a tentative command of the land. All of these factors led to regression and the ultimate downfall of the level of civilization which had been achieved.

Now it is the tenth century and chaos reigns. Swords and sorcery have replaced law and order as the way of life. Monsters roam the lands of CRON freely and do as they please. Isolated areas hold out against barbarism, but are doomed to fall. All that remains of CRON's glorious past are old wives' tales of mighty warriors and wizards doing battle against evil hordes and of a tragic lord, King Kalohn the Vanquished.



Table of Contents

INTRODUCTION	1
CHAPTER ONE: THE OPENING OPTIONS MENU	9
Main Options Menu	9
Create New Characters	9
View All Characters	12
Hirelings	12
Character Profile	13
Delete a Character	13
Rename a Character	13
Transfer Characters	14
Go To Town	14
Set Up Your Party	15
CHAPTER TWO: THE ADVENTURE BEGINS	16
Moving & Mapping	16
Game Commands While Marching	19
CHAPTER THREE: ENCOUNTER WITH DANGER	23
Encounter Commands	24
Combat	25
Saving Your Game	29
CHAPTER FOUR: BEGINNERS GUIDE TO ADVENTURE	30
The World	30
Your Characters	31
Weapons & Armor	32
Monsters	33
Quests	33
Spells	33
APPENDIX A: DETAILS & OPTIONS	34
Character Statistics	34
Character Classes	35
Character Race	36
Character Alignment	36
Sex of Character	37
Character Status	37
Secondary Skills	38
Armor, Weapons & Equipment	39
Time Travel	39
Auto-Mapping	39
APPENDIX B: SPELLS	40
Spells	40
Clerical Spells	41
Sorcerer Spells	50
EXAMPLE OF TOWN 1	59
MAPPING PAGES (Blank)	60-62

Might and Magic® II

Gates to Another World

is an ongoing journey that can last up to hundreds of hours. As you begin, let Chapters 1-3 of this book guide you through the first steps of your journey. If you are new to fantasy games, Chapter 4 will help acquaint you with the terms and conventions of this new world. As you gain in experience, your primary guide will become your computer screen. Even then you will find important reference information, on game options and spells, in the appendices of this book. Might and Magic One players should skim through the manual for new features.



Happy Adventuring!

Opening Options Menu

- Start Game** Allows you to proceed with the Game. It is recommended that you copy your disks before selecting this option.
- Demo** Demonstrates features of the game, ie. walking around, encounters, combat, etc. To return from the demo press "ESC".
- Copy Disks** Allows you to make Backup copies of your original disks. The Source disk is the Original. The Target disk is the disk you want to copy on to.
- # Of Drives** Lets you play with one or two drives. This option also works with Copy Disks.

Main Options Menu

Create New Characters

If you decide to play **Might and Magic** using the pre-programmed characters provided, you can skip this section.

Much of the fun of any fantasy game, however, lies in the creation of the characters with whom you go adventuring. If you are creating characters for the first time, or need to refresh your memory on character options, read Appendix A before continuing. The information in that appendix will help you create more varied and interesting characters, who have a greater chance of succeeding in their quest.

To create a new character, display the Main Options Menu and TYPE C.

A character's class is determined by 7 vital statistics.

MIGHT	INTELLECT	PERSONALITY	ENDURANCE
SPEED	ACCURACY	LUCK	

Each statistic is randomly assigned a rating between 3 to 21, with 21 being the highest. To generate a new set of random ratings, press **RETURN** (or **SPACE BAR** for animation).



Exchange Statistic

You may exchange any of the 7 statistics by pressing the letter of the statistic you want to exchange.

Select a Class

A character may belong to one of 8 classes.

KNIGHT
SORCERER

PALADIN
ROBBER

ARCHER
NINJA

CLERIC
BARBARIAN

To the right of the statistics are the eligible classes for the ratings given. These are the classes from which you may choose. Notice how the eligible classes change as you generate different sets of statistic ratings.

To choose a class, type the **NUMBER** next to the desired class. At any time *before* selecting a class, you can return to the Main Options Menu by pressing **ESC**.

Assign a Race

After selecting a class, choose the character's race.

HUMAN

ELF

DWARF

GNOME

HALF-ORC

To select race, type the **NUMBER** next to the desired race.

Your choice of race may change the rating given for one or more vital statistics. If the change is not to your liking, press **ESC**. All statistics will return to the last ratings shown before you selected a class. Re-select class, then try a different race.

Different races offer different bonuses:

All statistics will return to the last ratings shown before you selected a class.

<u>Race</u>	<u>Statistic Modifiers</u>	<u>Race</u>	<u>Statistic Modifiers</u>
Human	No additional modifiers	Gnome	+ 2 Luck - 1 Speed
Elf	+ 1 Intellect + 1 Accuracy - 1 Might - 1 Endurance	Half-Orc	+ 1 Might + 1 Endurance - 1 Intellect - 1 Personality - 1 Luck
Dwarf	+ 1 Endurance + 1 Luck - 1 Intellect - 1 Speed		

Select Alignment

After assigning race, select the character's alignment. Your choices are:

GOOD

NEUTRAL

EVIL

Select alignment by typing the **NUMBER** next to the desired alignment. If you change your mind after making your selection, press **ESC**. The screen will return to class options. Re-select class and race, then the desired alignment.

Notice that a character's alignment does not affect any vital statistic ratings. Alignment can be important to game play, however. For details on alignment, refer to Appendix A.

Choose Character's Sex

Your choices are **MALE** or **FEMALE**. Sex does not affect a character's vital statistics, but may restrict certain activities during game play. See Appendix A for details.

To select sex, type the **NUMBER** next to Male or Female. If you change your mind, press **ESC**. The screen will return to class options.

Name Your Character

The final step in creating a character is to name him/her. Type in ANY NAME, up to 10 characters in length. Then press **RETURN** to save.

It is a good idea to assign different names to each character, to avoid possible confusion during game play.

VIEW ALL CHARACTERS

From the Main Options Menu you can view a list of all Characters and Hirelings stored on your copy of disk B.

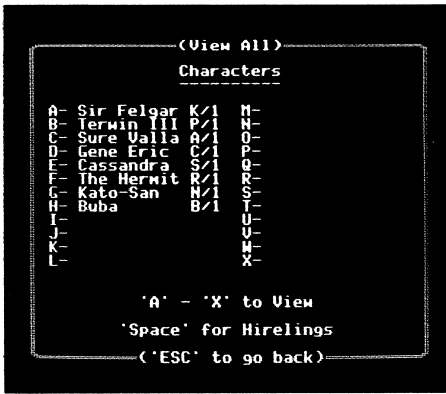

The View All list includes:

- KEY LETTER for character
- NAME of character
- CLASS of character
- TOWN in which character is currently located

From the View All list you can:

- 1) Press **ESC** to return to the Main Options Menu;
- 2) Type the **LETTER** (A-X) of the character to view a detailed Character Profile.
- 3) Press the **Space Bar** to toggle between Characters and Hirelings.

Hirelings

Hirelings are characters that are not created, but hired at various Inns throughout the game. When hired they act, and are controlled as normal party members except;

- 1) Initially there are no Hirelings for the characters to choose from. After completing various quests, deeds, etc. Hirelings will be made available to the party at selected Inns.

Note: After signing into an Inn, check to see if any Hirelings have become available for your party.

- 2) At the end of each day you must pay the Hirelings daily fee. If you are unable to pay the fee for that day they will leave your party and be waiting at the Inn in which they were last saved.
- 3) Hirelings may be dismissed at any time and will return to the last Inn at which they stayed (see Dismiss command).
- 4) When viewing a Hireling, instead of gold being displayed their cost per day will be shown.
- 5) Hirelings are not included in the process of Gathering or Sharing gold.

- 6) Hirelings may train for free when gaining Experience levels and Spells, consequently their cost per day will increase.
- 7) A Hireling's name may not be changed nor may the Hireling be deleted.

Caution: Abuse of Hirelings (ie. always placing them in the first position, removing their items and not replacing them with comparable items, etc.) may lead to a disgruntled Hireling, consequently increasing their cost per day.

Character Profile

A Character Profile gives you all the facts and figures on a specific character. It is an invaluable aid in decision making, when factors of strength, vulnerability, spells and wealth must be considered. Character Profiles are available at most times during game play. Only from the View All Characters list, however, can you display the profile of any character on the disk. All information on the Character Profile screen is in abbreviated form. A detailed description of each item on the screen is provided in Appendix A. Below is a brief overview of the screen.

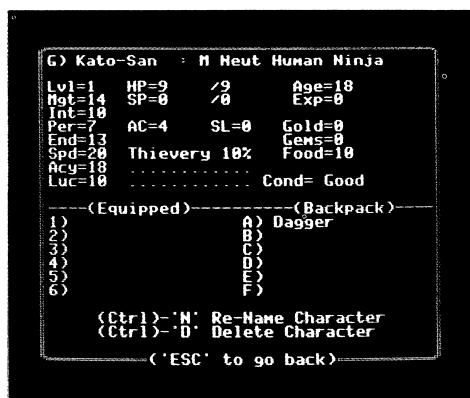

- Lvl** = Experience Level
- Mgt** = Might
- Int** = Intellect
- Per** = Personality
- End** = Endurance
- Spd** = Speed
- Acy** = Accuracy
- Luc** = Luck
- HP** = Hit Points
- SP** = Spell Points
- AC** = Armor Class
- SL** = Spell Level
- Exp** = Experience Points
- Cond** = Current Condition

Delete A Character

To delete the character displayed by the Character Profile, hold down the **CONTROL (CTRL)** key and press **D**. When asked: *Are You Sure (Y/N)?* press **Y** to confirm. The character will then be deleted from the disk B copy which you are using.

Rename A Character

To rename the character displayed by the Character Profile, hold down the **CONTROL** key and press **N**. Then type the **NEW NAME**, up to 10 characters, and press **RETURN**. The new name will replace the old name.

TRANSFER CHARACTERS

You may transfer characters from Might and Magic I to Might and Magic II. Be warned, certain restrictions apply! The transfer feature copies the entire 18 member roster, including empty spaces, from Book I and places them after the 6 pre-rolled characters in Book II, replacing any characters made by you in Book II. To avoid any problems, transfer the old characters before creating any new ones. The transferred characters are then modified as follows:

A: gold is set to 1000

B: food is set to 40

C: gems less than or equal to 100 remain the same while gems numbering over 100 are reduced to 100

D: character levels less than 7 remain the same, those 7 and above are reset to 7 if Book I was successfully completed, or to 6 if it was not

If you use the transfer feature more than once, realize that the 6 pre-rolled Might and Magic II characters are always reset to their original statistics and that any characters you may have placed in the first 6 slots will be replaced by them.

GO TO TOWN

Each time you play Might and Magic II, your party of adventurers sets out from the inn in one of five towns:

1 MIDDLEGATE 2 ATLANTIUM 3 TUNDARA 4 VULCANIA 5 SANDSOBAR

The town from which you set out is the town containing the characters in your party. All characters, pre-programmed or created, first start out in Town 1, so this is where you begin the game. Later, as your party travels to and lodges in other towns, you will set out from Towns 2-5.

From the Main Options Menu, type **G** to go to the towns. The screen will show the last town you signed into and the last characters you used will be selected. (To quickly continue playing, press **Z** to exit) If there are no characters in that town, no characters will appear in the list.

From the list of characters in the town, you can:

- 1) **View the Character Profile** for any character on the list. Press **ESC** to return to the list of characters in the town.
- 2) Press **SPACE BAR** to switch between Characters and Hirelings.
- 3) **Return to the Main Options Menu** by pressing **ESC**.
- 4) **Add or remove Characters or Hirelings** from the party.

Set Up Your Party

To add a character to your party, hold down **CONTROL** and press the **KEY LETTER** next to the character's name on the list of available characters. A ✓ will appear next to the character's name, marking him/her as a member of your party.

A party of adventurers may consist of a combination of created Characters and Hirelings:

- a. One created Character minimum and six maximum.
- b. Seven Hirelings maximum.

The total of **a** and **b** may not exceed eight.

Example: A standard party consists of 6 created Characters and 2 Hirelings. Experimentation with other combinations may prove more valuable.

When you have marked 8 party members, a message will indicate the party is full. To add a character at this point, you must first remove a character.

To remove a character from your party, hold down **CONTROL** and press the **KEY LETTER** next to the character's name. The ✓ marking the character as a member of the party will disappear.

As soon as you have marked one character as a member of your party, a new command option —**Z** (Exit) — will appear on the screen. Pressing **Z** will take you to the 3-D view of the inn, from which you may start out on your adventure.

NOTE: To stop the game and save information, you must get your party to the inn in one of the five towns, and sign in. See Chapter 3, **Battle Over**.



The Adventure Begins

MOVING & MAPPING

After you give the **Z** command, you truly enter the world of Might and Magic II. The screen shows a 3-D view of your present position, a list of possible commands, and a list of characters in your party, shown in marching order. (If a character is highlighted it indicates a condition other than good.) Since your view of the world is from your party's perspective, you do not see the members of your party.



You start inside the inn, facing the door. Turn around to sign back in, or simply move your party forward to leave the inn.

To move your party, use the following keys:

- (UP ARROW) or RETURN Move forward
 (DOWN ARROW) Move back
 (LEFT ARROW) Turn left
 (RIGHT ARROW) Turn right

When you press a forward or back movement key, the entire party moves one square forward or

backward. When you press the ← or → key, the entire party turns 90 degrees in that direction.

Unlocked doors open automatically as you move your party forward through them. However, if a door is locked, you must unlock it with the **UNLOCK** or **BASH** command...or find a way around it. (Warning: many locked doors are also booby-trapped, with the traps set to go off when you unlock or bash in the door.)

When you come up against an obstacle, such as a wall or mountain, a message will appear (i.e., SOLID, IMPASSABLE, etc.) These messages are particularly useful when traveling in the dark or testing for secret passageways.

Remember that you are now in a world of magic and danger, where all is not as it seems. Doors may lock behind you. Areas may be darkened by spells, requiring you to "feel" your way through them. Certain squares may teleport you across vast distances, into unmapped areas. And of course, any square may contain treasure or monsters.

The Map As Guide

Take some time to explore Middlegate (the first town) when you start out. To assist your party, a map of Middlegate is provided at the end of this book. The map is laid out in squares. A square represents the distance covered by your party when you press a movement key.

The map indicates the corridors, open passageways, walls and doors of the town. It also pinpoints key locations within the town — shops where items may be purchased, the temple where characters may be healed or cured, the training grounds where characters with sufficient experience points can advance in experience level, and the inn.

It does *not* tell you where monsters, treasures and other chance encounters are located.

Follow the map as you start to move through the town and notice how it relates to the 3-D view on the screen. The screen allows you to see an area 3 squares wide by 4 squares deep, unless walls or other solid obstructions block your view.



The same section as seen on the screen, with your party facing north.

The same section as seen on the screen, after a 90 degree turn to the right. Your party is facing east.

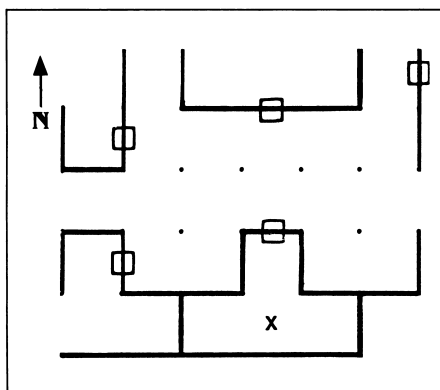

You are here.
Section of Middlegate map.

By following the map as you move through Middlegate, you will become familiar with the 3-D perspective and gain valuable insight into the process of mapping. After you move out of Middlegate, you will need to create your own maps of subsequent towns, outdoor areas and underground caverns.

Tips on Mapping

1. Photocopy and use the blank maps provided at the end of this book. Each blank map is a dot grid, 16 by 16 squares in area. Connect the dots to indicate walls or other obstructions. Leave dots unconnected to indicate open passageways. Mark the area and level being mapped.
2. Remember that the 3-D screen always shows what your party sees, as it looks forward. At first, stop each time your party moves a square, and add the new square shown on the 3-D view to your map.
3. If you have trouble visualizing your orientation, turn the map when you turn your party. If you turn your party RIGHT, turn your map LEFT. Add the new view shown on the screen to your map, before you move again.
4. Mark locked doors, secret passageways, dark areas, special features (especially outdoors) and messages.
5. Mark areas where you can be sure of encountering monsters (such as a dragon's lair), but don't bother marking every square in which you encounter monsters or treasure. Chances are, they will appear in a different square next time.
6. If you want exact coordinates, are unable to map, or do not want to map, see Sorcerer Spell: Location.
7. The Sorcerer Spells: Eagle Eye and Wizard Eye, will also help in mapping.



GAME COMMANDS WHILE MARCHING

While your party moves through the 3-D view of the world, you may use any of the commands shown on the screen. The key used to give the command appears to the left of the command. When the # sign is given, type the **CHARACTER NUMBER** from the character list at the bottom of the screen.

COMMAND	PRESS	DESCRIPTION
FORWARD	↑ or RET	Move entire party one square forward
BACK	↓	Move entire party one square back
LEFT	←	Turn entire party 90 degrees left
RIGHT	→	Turn entire party 90 degrees right
BASH	B	Attempts to knock down a locked door. If successful, the party moves forward through the door. If the attempt fails, the party does not move. In either case, bashing a trapped door is likely to set off the trap.
CONTROLS	C	Lets you select sounds, party disposition and message delays. Party Disposition — This is the party's outlook and adventuring style. Novice players should set their disposition to <i>Inconspicuous</i> until they become more familiar with the game. When seeking more challenging encounters and more valuable treasure, the <i>Aggressive</i> or <i>Thrill Seeker</i> options may be selected. We recommend the <i>Average</i> setting for the majority of play.
DISMISS	D	Lets you select a Hireling to dismiss. When you rest, you pay the Hirelings. If you do not wish to pay a Hireling for the next day, you must dismiss him/her. Before resting, the Hireling will return to the last inn in which they stayed.
EXCHANGE	E	Character changes battle position with any other member of the party. A prompt asks with which party member the exchange is to take place. Press ESC before selecting the exchange party member to abort the command and return to the combat options list for another selection.
QUICK REF	Q	Displays a brief overview of all party member's: Hit Points, Spell Points, Level, Spell Level, Armor Class, Age, Gems, Food, Condition. To return to the 3-D screen, press ESC .
REST	R	Rests party overnight in square currently occupied. Rest restores all characters' Hit Points and/or Spell Points, unless inhibited by special conditions. Rest requires and

COMMAND	PRESS	DESCRIPTION
		uses 1 food unit from each character's food supply. All protection spells wear off during rest and must be re-cast upon awakening.
		Party may encounter monsters during rest. If so, some members of the party will enter the encounter with their condition listed as asleep. If the area is too dangerous, the party will not be allowed to rest in that square. Time does pass in the land of Cron and many events are time related. See Time Travel section, page 39, for more details.
SEARCH	S	<p>Finds treasure or other items hidden in square occupied by party. You should <i>always</i> search after defeating a monster and before moving off the square in which the encounter occurred. However, you do not need to search immediately after combat. You may want to rest, cure wounds, etc. first.</p> <p>When a chest is found there are 3 options available:</p> <ol style="list-style-type: none"> 1. Open it — Simply opens the chest. If there is a trap it will probably go off. 2. Find / Remove Trap — Opens chest carefully, using the robber's thieving ability and reducing the chance of a trap being set off. 3. Detect Magic/Trap — Detects whether the contents of the chest are magical and whether or not the chest has a trap. May only be selected by a character with sorcerer spells.
UNLOCK	U	<p>Allows one character an attempt to pick the lock on a door. Only a robber has any real chance of success. If the attempt succeeds, the door will be unlocked and any traps will be disarmed, so the party may move forward.</p> <p>If the attempt fails, the door will remain locked and any existing traps may be set off. The attempt may be made again, but each subsequent failure increases the likelihood of setting off traps.</p>
VIEW CHAR	#	<p>Displays the Character Profile for that character. (See Chapter 1 for a description of Character Profile.) At the bottom of the Character Profile is a set of options which may be exercised only while adventuring.</p> <p>Quick Ref (press Q) Displays a brief overview of all party member's Hit Points, Spell Points, Armor Class and Condition.</p>

From this list, you can view an individual Character Profile, by pressing his/her **CHARACTER NUMBER**. To return to the original screen, press **ESC**.

Cast (press **C**). Displays a character's Spell Book which lists all known spells for that character. Then prompts you to cast a non-combat spell, providing the character may cast spells at that level and has the required number of spell points and magical gems. Prompts ask for spell level and number, and other information if needed. See Appendix B for spell descriptions.

Discard (press **D**). Permanently removes item from character's backpack. Follow screen prompts.

Equip (press **E**). Shifts an item from character's backpack to equipped area so character may use it. A maximum of 6 items may be equipped at any given time. Not all items must be equipped in order to be used (i.e., a potion may be used from the backpack).

Items which must be equipped include armor and other clothing, weapons, and shields. Restrictions follow the laws of logic. A character can only wear one suit of armor at a time; can only be equipped with one hand-to-hand weapon and one missile weapon simultaneously; cannot be equipped with a shield if equipped with a two-handed weapon; and so on.

NOTE: Equipping a character with armor may affect his/her Armor Class.

Gather (press **G**). Transfers all gold, gems and food carried by other party members to that character, up to the maximum amount of each item which the character can carry.



COMMAND	PRESS	DESCRIPTION
---------	-------	-------------

Remove (press **R**). Shifts item from equipped list to backpack if there is room in the character's backpack for the item. Follow the screen prompts.

Share (press **S**). Evenly distributes all gems, gold or food in the party's possession among all party members. Follow the screen prompts.

Trade (press **T**). Transfers an amount of gems, gold or food, or a particular item, from viewed character to another character. Follow screen prompts.

Use (press **U**). Activates an item that has special powers. Items may or may not also need to be equipped for use. Follow the screen prompts.

If an item has limited power, a spell can be cast to reveal the number of charges remaining. See Appendix B for spell descriptions.

PROTECT	P	Displays currently active spells covering the entire party. Light spells also show, in parentheses, the current number of light units available to the party. One light unit is needed to light up a dark square while occupied by the party. Light units are automatically used when the party steps into a darkened square.
---------	---	---

Magic shows the percentage of magic resistance of the party. Forces shows the percentage of elemental forces resistance. Levitate, Walk on Water, and Guard Dog appear when they are active.

If either of the spells Wizard Eye (indoor) or Eagle Eye (outdoor) are active, the upper right hand corner of the screen will display a 5x5 overhead view of the party's location and facing by an arrow at the center.

MAP/LOCATION	M	This option is not shown on the screen. By pressing M, the equivalent of casting the sorcerer spell Location will occur. This allows you to use the Auto Mapping feature more readily. (See Auto Mapping, page 39, for more details.)
--------------	---	---

OTHER WINDOWS

Across the center of the screen is the status line which allows you to toggle between Options and the Protection screen. It also displays the current Day, Year, Facing of the party and other relevant events like encounters, solid walls, locked doors, etc.

The character window at the bottom of the screen displays the characters names in their marching order along with their current hit points. Other text may also temporarily appear in this window.

Encounter with Danger

During your explorations, your party will encounter many creatures, characters and special places. Encounters, while often filled with danger, are necessary if your characters are to accumulate experience points. Encounters, therefore, should not be avoided. Of course, if an encounter appears to be more than your party can handle, do whatever is necessary to survive – run, bribe, hide, etc.

Most creatures that you encounter will be monsters. Monsters usually travel in groups. A group may be homogenous or include a mixture of different types.

There are hundreds of different monsters, some timid, some highly dangerous. Different monsters have different powers, capabilities, speeds and armor classes. You will learn about each type of monster as you encounter and (frequently) battle it.

When an encounter occurs, the screen will change. The command / protection list will be replaced with a list of creatures encountered. A picture of the most powerful creature will appear in the center of the 3-D view. A set of options will appear below the monster.

Your encounter options will vary, depending on whether the monster(s) surprises you, you surprise them, or neither party is surprised.



If the monster(s) surprises your party, you go directly into combat. There are no other options. Combat is covered in this chapter, beginning on page 25.

If your party surprises the monster(s), you have the option to advance or not. If you choose to avoid the monster(s), nothing further occurs. The encounter is over. If you *do* advance, you are given the same options as when neither party is surprised.

If neither party is surprised, you have several encounter options. Note that the option you choose may affect your character's alignments.

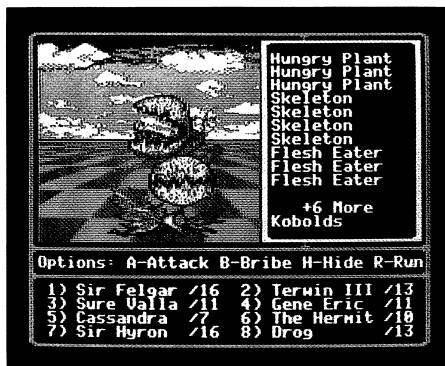

Encounter Commands

COMMAND	PRESS	EFFECT
ATTACK	A	This takes you to combat. See the section on combat.
BRIBE	B	Your party attempts to buy off the monsters with bribes. If the monsters refuse your attempt, combat will begin. If the monsters accept your attempt, a prompt will ask "bribe with what: Food, Gold, Gems". Select one of the options and another prompt will ask how much. Type amount of bribe and press RETURN . If they accept, encounter is over and they may even choose to give you a message. If they refuse the bribe, the party will immediately go to combat.
HIDE	H	This is similar to Run except the percentage of failing is greater, but if you succeed you will remain in the same square.
RUN	R	Your party attempts to flee from the monsters. If the retreat succeeds, your party will be moved to the safest square within the immediate 16x16 square area. (You may need to cast a spell to discover your exact location.) If the retreat fails, combat will begin.

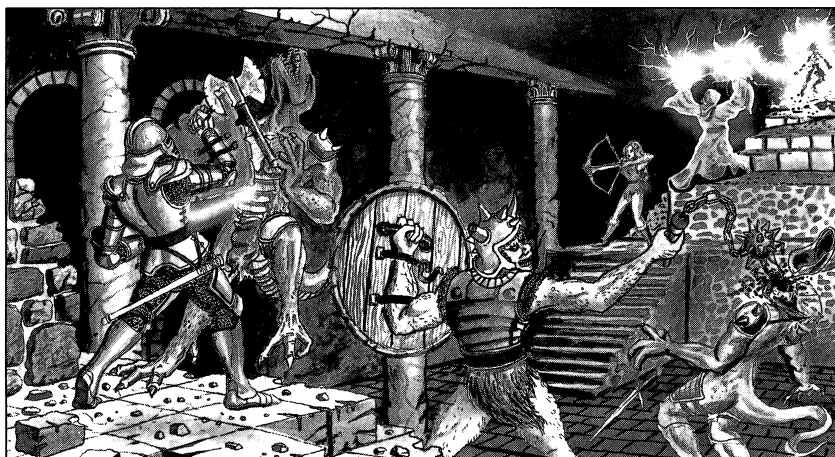

COMBAT

Combat is the heart of *Might and Magic II*. By battling and defeating monsters and other creatures, your party will gain experience points and any treasure which the monsters are carrying. Both are necessary for characters to advance in skill level and ability.

Only one character or monster acts at a time. The order in which both characters and monsters act is based on their individual speed. The fastest character or monster goes first, followed by the next fastest, and so on. Each character or monster attacks once per round. A new round starts after all characters and monsters have had a turn.

When a monster's name is highlighted, it is that monster's turn to act in the current combat round.

The character's name appears below **Options for:** when it is his/her turn in the current combat round.

A character's or monster's turn in combat is known as combat initiative.

On the right side of the screen is a list of monsters, in the order in which your party encounters them.

A ✓ in front of a character number or monster letter indicates that the character or monster may engage in hand-to-hand combat. With the exception of archers, characters who can engage in hand-to-hand combat cannot use missile weapons.

The character list at the bottom of the screen can be used to determine which character is in which battle position. If a character's name is highlighted it indicates a condition other than good.



Battle Options

When a party member has the combat initiative there are 9 battle options available.

Once you complete a battle option, the results of your action appear on the screen almost immediately. The message remains for the duration set by the DELAY command or by default.

COMMAND	PRESS	EFFECT
ATTACK	A	Character attacks monster in the A position, with whatever weapon he/she has equipped. If the monster in the A position dies as a result of the attack, all other monsters move up one position.
FIGHT	F	Character attacks monster in any hand-to-hand battle position, with whatever weapon he/she has equipped. A prompt asks which monster is being attacked. Abort the command by pressing ESC before selecting a monster. You will return to the combat options list for another selection.
SHOOT	S	Character fires missile weapon. This command appears for any party member who has a missile weapon equipped and is not engaged in hand-to-hand combat. It also appears for an archer, even if engaged in hand-to-hand combat. A prompt asks at which monster the character is shooting. Press ESC before selecting a monster, to abort the command and return to the combat options list.
CAST	C	Character casts a combat spell. This command only appears for spell casters. Prompts ask for spell level, spell number, and any other information required. Press ESC before entering final spell information, to abort command and return to the combat options list.
USE	U	Character activates special power for any item in his/her possession. A prompt shows all items in character's possession and asks which is to be used. Press ESC before selecting an item to abort the command and return to the combat options list.

BLOCK	B	Character increases his/her Armor Class for that round only.
RUN	R	Character attempts to run away and seek safety. If the character gets away. . . a) and the party wins, he/she will rendezvous with party after combat. b) and the party dies, he/she can attempt to return to an inn and revive the party. c) and the rest of the party succeeds in running, all will regroup immediately after combat.
EXCHANGE	E	Character changes battle position with any other member of the party. A prompt asks with which party member the exchange is to take place. Press ESC before selecting the exchange party member to abort the command and return to the combat options list for another selection.
VIEW	V	View a characters profile.

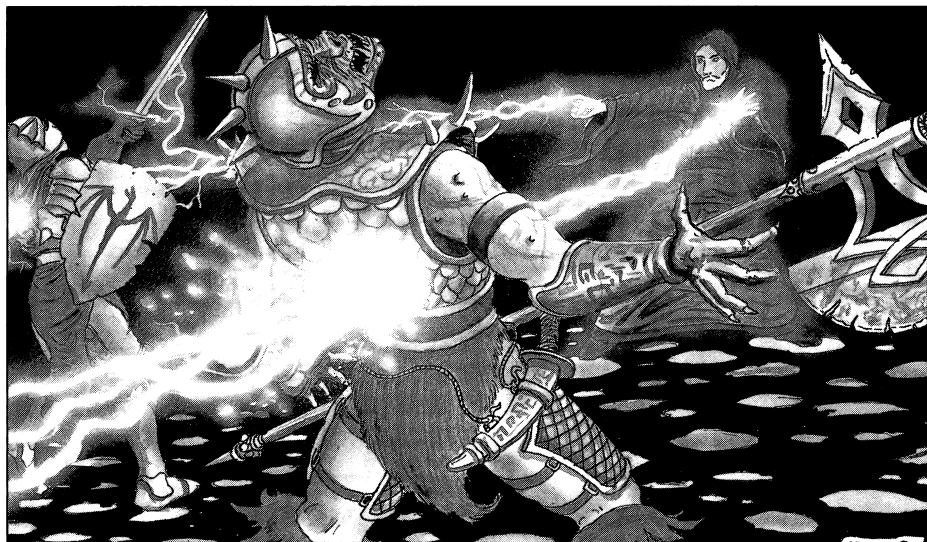

COMMAND	PRESS	EFFECT
OTHER OPTIONS:		
DELAY	D	Allows you to set the duration of on-screen messages to any number between 0 and 9. (0 is the shortest duration, 5 is the default.)
PROTECT	P	Allows you to see all currently active spells which cover your entire party.
QUICKREF	Q	Displays the QUICKREF list of characters in your party, including Hit Points, Spell Points, Armor Class and Condition. From this list you can view an individual Character Profile, by pressing the CHARACTER NUMBER . To return to the combat screen, press ESC .
VIEW CHAR	#	Displays the Character Profile for that character. (See Chapter 1 for a description of the Character Profile.) From the Character Profile, you may type Q to return to the Quickref screen, or press ESC to return to combat.

For Advanced Players

To speed up combat, hold down **CTRL** and **A** together. The character with the combat initiative will:

- attack the monster in position A, if engaged in hand-to-hand combat;
- shoot the monster in position A, if not in hand-to-hand combat but in possession of a missile weapon;
- block, if neither in hand-to-hand combat nor in possession of a missile weapon.

Battle Over

Combat continues until either side retreats or is completely destroyed. At the end of the battle, a message indicates the number of experience points gained in combat for each surviving member of your party. Party members who are dead, eradicated or turned to stone do not receive experience points.

After combat, the screen returns to the 3-D view of the world, your journey continues, and your party will return to its original marching order, regardless of any position changes made during combat.

IMPORTANT: Before moving your party off the square within which combat occurred, **SEARCH** the square for treasure. Most monsters carry treasure of some sort with them.

You may, of course, take care of other business (healing wounds, resting, etc.) before you search the square.

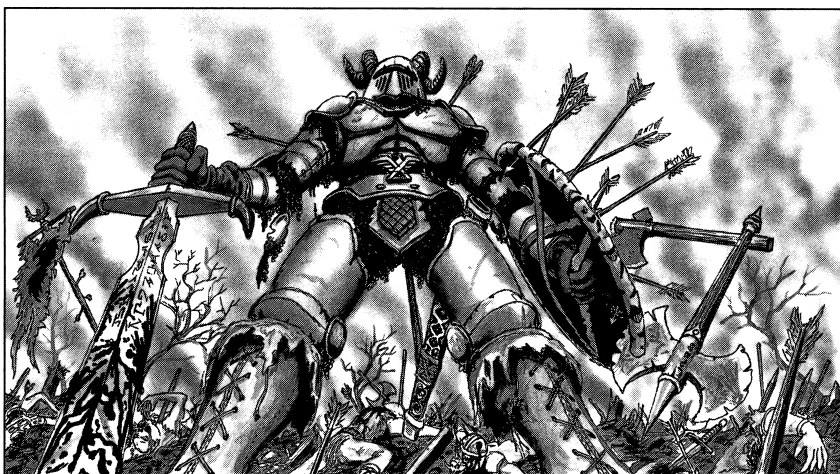

SAVING YOUR GAME

If you need to interrupt the game, but save the experience points and other abilities gained by your characters during the most recent game session, you must take your party to the inn in one of the five towns and **SIGN IN**. When you enter the inn, you will be asked if you want to sign in. By answering **Y** (Yes) you will save your character's current statistics and status on your disk B copy. Should your party die, all gold, items, and information gained since you last visited an Inn (saved the game) will be lost. Any important quests or clues found during this time should be reaccomplished.

The next time you play, you may resume the game from the inn and town containing your party of adventurers...or start from another town with a different party.

Beginners Guide to Adventure

The object of an adventure game is the game itself, rather than a particular goal. During the game, you assume the roles of the characters in your party, sharing their uncertainties and adventures.

There are certain conventions to most adventure games, which may vary in detail but are essentially similar. These conventions are the subject of this chapter. The details are covered in the following chapters and the appendixes of this book.



The World

When you begin, the uncharted world of *Might and Magic II* is as strange and unfamiliar to you as it is to your characters. It is up to you to map the world while traveling through it.

Throughout the world of Cron you will explore various towns, mysterious caverns, dangerous dungeons, majestic castles, and treacherous outdoor terrains.

In general, the more dangerous an area is, the more treasure you can expect to find there...if you survive.

Towns are important because they contain:

- **Shops** where food, weapons, armor and other equipment may be purchased.
- **Temples** where sick or injured characters may be healed.
- **Training grounds** where characters may advance to higher experience levels, provided they have the required number of experience points.
- **Inns** where characters must be taken for safe harbor at the end of each game session, if the game information is to be saved.

Underground caverns and dungeons contain multiple levels, with the danger (and possible gains) increasing at each lower level.

Castles offer numerous quests that can prove rewarding in experience and gold.

The outdoor area is divided into five sections. The four elemental zones (Water, Air, Fire, and Earth) and the central world.

While detailed maps of the world provide you with a certain measure of security, they by no means guarantee your safety. Monsters may take up residence at any time in areas that were once free of danger. Magical portals may appear and disappear at random. Follow your maps, but be prepared to improvise.

Your Characters

Any character that you create — regardless of class, race, alignment or sex — starts out a little wet behind the ears. He/she is 18 years old and is at experience level 1.

EXPERIENCE POINTS reflect the amount of adventuring and combat experience which the character has gained.

A character's EXPERIENCE LEVEL is a measure of that character's power and abilities. It reflects the amount of adventuring and combat experience which the character has gained while traveling. At higher experience levels, a character is able to cast more powerful spells, is able to inflict greater damage in battle, and is able to sustain more damage from physical attack. A character rises to the next experience level *only* when he/she has accumulated the required number of experience points, from defeating monsters in battle, completing quests, or performing other deeds of heroism.

A character is defined by CLASS, RACE, ALIGNMENT and SEX, with class being the most significant characteristic.

It is important to note that while all characters of a particular class share certain abilities and limitations they are not all identical... particularly as the game progresses and they gain in experience at different rates. Other vital statistics, as well as the character's race, also subtly affect a character's abilities.

All characteristics are explained fully in Appendix A, and must be chosen by you when you create a character.

Weapons & Equipment

Different classes of characters are permitted to wear different types of armor and use different weapons. Weapon and armor restrictions are described in detail in Appendix A.

Other equipment items (compass, ropes, lanterns, etc.) are also available, and may be purchased in town shops or found along the way. However, it is necessary to choose carefully the articles which a character purchases or picks up.

Each character has a **BACKPACK**, in which he/she may carry up to 6 items. Once the pack is full, new items can be added only after discarding another item or shifting it to another character's pack.

In addition to the backpack, each character can wear or carry another 6 items which are **EQUIPPED** or readied for use. Items such as armor and most weapons *must* be equipped in order to use them. If a character goes into combat with armor and weapons safely stashed in his/her pack, they will be of no use whatsoever. There are restrictions regarding the number and types of armor and weapons which may be simultaneously equipped. These restrictions are explained in Appendix A.



Monsters

The term MONSTER is a little misleading, for it implies danger and evil. There are over 250 *types* of monsters in the world of Might and Magic II and each one is different. Some are highly dangerous and extremely difficult to defeat. Some would rather be bribed than fight. Others are relatively timid and will run away when you approach them. A few may even help you.

In general, the monsters you encounter will be proportionate with the overall experience level of your party. As your characters advance to higher experience levels, they will encounter more dangerous monsters. Since monsters usually guard treasure of one sort or another, more advanced characters will also have greater opportunities to increase their wealth.



Quests

As you journey, you will meet various inhabitants of the world (other than monsters) who may offer you quests, or seek your assistance on their own quests. You will always have the option of accepting or refusing any quest offered. However, if you accept, you must complete the quest in order to gain experience points. Most quests can be executed simultaneously, however some may require the services of a temple to release you to accomplish other quests.

Spells

Only certain classes of characters may cast spells. (See Appendix A.) There are 96 different spells, divided into CLERIC and SORCERER spells, with 9 SPELL LEVELS in each division. Characters who may cast cleric spells may not cast sorcerer spells, and vice versa.

The level of spell which a character may cast is determined by his/her experience level.

All spells cost a certain number of SPELL POINTS. Higher level spells may also cost a number of magical GEMS. Most spell casting characters begin with a small number of spell points and gain additional points with each experience level reached. Gems must be found along the way.

All spells are completely described in Appendix B of this book.

Details & Options

Character Statistics

Each character receives a random rating from 3 to 21, in each of 7 vital statistics. Because these ratings establish a character's strengths, weaknesses and abilities, they also determine his/her class (knight, paladin, archer, cleric, sorcerer, robber, ninja, barbarian).

Throughout the game, a character's actions, discoveries and battles may affect one or more of his/her vital statistics. Certain spells may even cause a vital statistic to exceed the normal maximum rating of 21. If, however, any vital statistic drops to 0, the result is death for the character.

MIGHT. A character's strength. It affects damage done by a character in battle.

INTELLECT. A character's general knowledge. Affects sorcerer spell points.

PERSONALITY. A character's general charisma. Affects cleric spell points.

ENDURANCE. A character's stamina in battle. Affects Hit Points (the amount of damage that can be sustained before death).

SPEED. A character's quickness and agility. Higher speeds increase a character's Armor Class. Speed also determines the order of combat during the battle, with the fastest character or monster going first.

ACCURACY. A character's ability to land a blow on the enemy during combat.

LUCK. A character's chance of succeeding, when all else fails. A random element whose effects cannot be predicted.

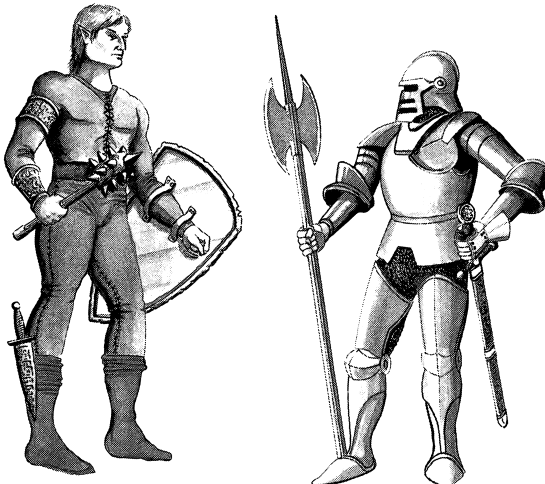

Character Classes

KNIGHT. Prime statistic (15 or greater): MIGHT.

Hit points gained per experience level: 1-12*.

Spell skills: None.

A knight begins with the best all-around fighting skills of any character. He/she can use any weapon or item of armor, unless of opposite alignment or designed exclusively for another class.

PALADIN. Prime statistic (13 or greater): MIGHT, PERSONALITY, ENDURANCE.

Hit points gained per experience level: 1-10*.

Spell skills: Clerical, at higher experience levels.

A paladin can use any weapon or item of armor, unless of opposite alignment or designed exclusively for another class. General fighting skills are equal to an archer's except that a paladin cannot use missile weapons during hand-to-hand combat.

ARCHER. Prime statistic (13 or greater): INTELLECT, ACCURACY.

Hit points gained per experience level: 1-10*.

Spell skills: Sorcerer, at higher experience levels.

An archer can use any weapon, unless of opposite alignment or designed exclusively for another class. An archer can wear only chain mail or lighter armor, and cannot carry a shield. An archer can use any missile weapon, even during hand-to-hand combat.

CLERIC. Prime statistic (13 or greater): PERSONALITY.

Hit points gained per experience level: 1-8*.

Spell skills: Cleric (defensive, healing).

A cleric can use splint mail or any lighter armor, and can carry a shield. Weapons are restricted to clubs, maces, cudgels, whips, mauls, flails, staves and hammers. A cleric may not use missile weapons. At higher experience levels, a cleric gains the ability to use higher level spells.

SORCERER. Prime statistic (13 or greater): INTELLECT.

Hit points gained per experience level: 1-6*.

Spell skills: Sorcerer (offensive, combative).

A sorcerer may wear only padded armor and may not carry a shield. Weapons are restricted to clubs, whips, pipes, staves, knives and daggers. As a sorcerer advances in experience level, he/she gains the ability to use more powerful, high level spells.

ROBBER. Prime statistic (13 or greater): LUCK.

Hit points gained per experience level: 1-8*.

Spell skills: Pick locks, find traps, backstab.

A robber's armor is limited to chain mail and shield. Weapons include sling, crossbow and all one-handed weapons, such as a short sword or dagger. As experience levels increase, the robber increases his/her ability to pick locks and disarm traps and successfully backstab during combat. A robber's fighting abilities equal those of a cleric. Robbers have the best chance to pick locks, find traps, as well as having a special attack-backstab. A robber's first attack, if possible, will automatically attempt to be a backstab. A successful result will be displayed, incurring extra damage.

NINJA. Prime statistic (13 or greater): ALL

Hit points gained per experience level: 1-8*

Special skills: Pick locks, find traps, backstab and assassinate.

A ninja's armor is limited to ring mail or lighter armor and cannot carry a shield. A ninja can use most one handed weapons but only swords specifically designed for a ninja. Two handed weapons are limited to staff and naginata. Most missile weapons can be used. Ninjas have the same abilities as robbers except to a lesser degree. A Ninja's first attack, if possible, will automatically attempt to be an assassination. A successful result will be displayed, incurring extra damage.

BARBARIAN. Prime statistic (15 or greater): ENDURANCE

Hit points gained per experience level: 1-12*

Special skills: None

A barbarian begins with the greatest number of Hit Points. Barbarians are limited to scale and lighter armor and can use most shields. A barbarian can use most weapons except swords. Missile weapons are limited to slings and blowpipes.

In selecting characters to make up a party of adventurers, it is a good idea to start with one member from each class. This allows you to avail yourself of the special skills and abilities offered by each class.

*The number of Hit Points gained per experience level may be increased by a character's endurance rating. The number of Hit Points with which each character starts the game is equal to the maximum number of points which each can gain per level, modified by endurance rating.

Character Race

Although there are no restrictions on the race to which any character may belong, selection of certain races may change the rating on one or more of a character's vital statistics. In addition, different races have different hidden strengths, which do not show up in a character profile. In general, these are:

HUMAN. Strong resistance to sleep spells and poison.

ELF. Some resistance to sleep spells.

DWARF. Strong resistance to poison.

GNOME. Some resistance to magic spells.

HALF-ORC. Some resistance to sleep spells and poison.

Although racial resistances are never noted during the game, they may be important in overcoming the effects of various forms of magical attack. It is therefore a good idea to strive for a racially mixed group, when creating a party.

Character Alignment

In *Might and Magic II*, good and evil are not absolute, but rather a measure of the character's inclinations when confronted by the unknown. Throughout the game, a character's responses to encounters and combat can shift his/her alignment, as can certain spells.

A character's alignment will occasionally restrict his/her activities while adventuring. Certain places, items and weapons are designated good or evil. These cannot be entered or used by a character of *opposite* alignment. A *neutral* character can enter an alignment restricted place, but cannot use a restricted item.

Sex Of Character

Sex in Might and Magic II means gender. Any character may be either male or female. Sex does not affect a character's vital statistics, or normally restrict his/her activities during the game. However, it is still advisable to include both male and female characters in your party, since you may encounter items, places and and/or activities that are available only to members of one sex or the other.

Character Status

On the Character Profile Screen you will find abbreviated information about an individual character's status, in a number of different areas. These include:

CHARACTER OPTIONS: Assigned when you created the character. These include name, sex, alignment, race and class.

LEVEL: The experience level which the character has achieved. This starts at 1 and rises as the character gains experience through combat and training. At higher levels, a character gains in abilities and power according to his/her class (ie. a knight will attack more than once as his/her levels increase).

HIT POINTS: Number of damage points which the character can sustain in combat. At 0 unconsciousness sets in. Any damage after that results in death. Shown are the current number of points/the maximum number which can be accumulated.

SPELL POINTS: Number of points available for use in casting spells. Each spell costs a certain number of spell points, usually equal to the level of the spell. Shown are the current accumulation of points/the maximum accumulation of points.

ARMOR CLASS: This number denotes a character's vulnerability to physical attack in combat. The higher the number, the less chance that a character will sustain damage from an attack. Normally ranges from 0 to 30, depending on such things as armor, shields, speed, spells, etc.

SPELL LEVEL: Shows the highest spell level that can be cast.

AGE: Starts at 18 and grows older as the game progresses. As a character ages, his/her skills begin to deteriorate as vital statistic ratings drop. After about age 80, a character can die while resting overnight, from old age. Age can be delayed or reversed by a rejuvenation spell.

EXPERIENCE POINTS: A running total of all points gained from defeating monsters, completing quests, etc. Experience points determine a character's eligibility for various types of training and for advancement to the next experience level. Approximately 2000

points are needed to advance from level 1 to level 2. Point requirements generally double with each subsequent level.

THIEVERY: This is a measure of a character's ability to perform thieving skills (pick locks, find traps, etc.). Certain items, as well as training can modify this statistic.

SECONDARY SKILLS: Characters may learn secondary skills while adventuring. A character may only have two such skills at any one time. These skills provide many benefits including the ones listed below:

Arms Master – increases accuracy with weapons

Athlete – increases speed

Cartographer – enables the auto-mapping feature.

Crusader – allows the character/party to be bestowed quests.

Diplomat – increases personality

Gambler – increases luck

Gladiator – increases might

Hero/Heroine – all stats are raised

Linguist – increases intellect

Merchant – receives most favorable price when buying or selling.

Mountaineer – allows passage over any mountain range if at least two party members retain this skill.

Navigator – keeps party from becoming lost in large, open spaces.

Pathfinder – allows passage through any forest area if at least two party members retain this skill.

Pickpocket – increases thievery

Soldier – increases endurance

GOLD: Number of gold pieces which the character is carrying. Gold is needed to purchase armor, weapons, food and other useful items. Gold must be acquired along the way.

GEMS: Number of magical gems which the character is carrying. Gems, which must be found, are required to cast many higher spells.

FOOD: The number of food units which a character is carrying. One unit equals a one-day supply of food. One food unit is needed to regain Hit Points and/or Spell Points during rest. Each character starts with 10 food units and may carry a maximum of 40 food units.

CONDITION: Character's overall state; i.e., good, poisoned, asleep, unconscious, dead, etc. More than one condition (other than good) may exist simultaneously. Any condition other than good should be remedied as soon as possible.

EQUIPPED: Displays items in character's possession which have been equipped for use. Items which must be equipped before they can be used include armor, shield, weapons, cloak, etc. (in general, any item which must be carried, worn or prepared for use). Up to 6 items may be equipped at a time. Items are restricted by the laws of logic; i.e., only one suit of armor at a time, only one 2-handed weapon, and so forth.

BACKPACK: Lists items being carried in character's backpack. Items in backpack are not (and may not need to be) equipped for use. Up to 6 items may be carried in a backpack at a time. Items can be discarded, added or shifted while adventuring.

Armor, Weapons & Equipment

Various types of armor, weapons, and adventuring items (rope, torches, etc.) are available for purchase, to help your party. Hundreds of magical items, weapons and armor can also be found.

Most standard articles, can be purchased in the various town shops. When you enter a shop, you will be presented with a list of available items and prices. As a rule, the more expensive articles are more powerful, offer greater protection, etc.

A WORD TO THE WISE: Don't waste money purchasing items which your character cannot equip due to class restrictions.



Time Travel

During the course of play it will become necessary for your party to travel through time. You begin the game in the 10th century (the year 900). This is the true time and visits to the past are merely temporary. Each century is unique unto itself, therefore, places, people and things may not be present in all centuries. While traveling in time, your stay in any century is limited to a random amount of time. Consequently, while resting, you may be transported back to the 10th century to the moment at which you left.

Auto-Mapping

Might and Magic II is equipped with a complete Auto-mapping function. Every square or location in which the party stands is remembered by the game.

Note: You must have a character with Cartographer secondary skills for Auto-mapping to work.

When viewing the map from the Location Spell all the locations that the party has been in for the current 16x16 area are shown.

Note: You may only view the map of the area in which you are in, therefore, it may become desirable to copy the maps onto the mapping paper.

Spells

There are 96 spells—48 clerical and 48 sorcerer—with 9 levels in each division. A spell-caster may cast spells at any level up to the *maximum* level shown on his/her Character Profile. The LEVEL NUMBER must be entered at the **Level:** prompt when casting a spell.

Acquiring Spells

Spell levels are gained from the following table according to the level of the caster.

Spell Level:	1	2	3	4	5	6	7	8	9
Level of Caster:	1	3	5	7	9	11	13	15	17

Initially, when a new spell level is gained only some of the spells are inscribed into the character's Spell Book. The remainder of the missing spells must be purchased in towns (Temples for clerics, Mage Guilds for sorcerers) or found throughout the game.

Spell Book

Each spell-casting character has a Spell Book which can be seen at an Inn while viewing a character or when casting a spell. The Spell Book will appear on the screen with the spell number on top and the spell level at the left hand column. A ✓ indicates that the spell is available.

The spell descriptions in this appendix include:

NUMBER: The number preceding the spell name. Enter this number at the **Number:** prompt when casting a spell.

NAME: Generally descriptive of what the spell does.

COST: The number of spell points (SP) and, in some cases, gems required and used up in casting the spell. A spell point followed by /L means per experience level of caster.

TYPE: When and where the spell may be cast. Some spells may only be cast during combat; some only in non-combat situations; some anytime. Most spells may be cast anywhere, so this may be assumed unless a spell is marked specifically Indoor or Outdoor.

OBJECT: Character(s) or monster(s) affected by the spell. If a spell affects a single character or monster, a prompt will ask *which* character or monster, when you cast the spell. Some spells have an area of effect (ie. not in hand-to-hand monsters) and any characters caught in this area will also be affected.

DESCRIPTION: Additional information about the spell.

NOTE: Most monsters have some type of defense against magic. There is no guarantee that a spell cast against a monster will succeed, or inflict the full damage intended. Spells which are cast for the duration of combat may be undone by the monster before combat is over. After each round, a monster will attempt to overcome any spell against him...and may succeed. Some monsters may even cast a "Dispel" removing all existing spell against both monsters and characters.

A quick reference spell chart can be found on the back of this manual.

Clerical Spells

Level 1

1. NAME: **Apparition**
COST: 1 SP
TYPE: Combat
OBJECT: 10 monsters
DESCRIPTION: Creates a frightening apparition in the monsters memory causing them to be afraid, reducing their chance to hit.
2. NAME: **Awaken**
COST: 1 SP
TYPE: Anytime
OBJECT: All sleeping party members
DESCRIPTION: Awakens all sleeping members of the party, instantaneously cancelling the sleep condition. May be critical if party is attacked during rest.
3. NAME: **Bless**
COST: 1 SP
TYPE: Combat
OBJECT: Entire party
DESCRIPTION: Increases the accuracy with which all characters fight, for the duration of combat.
4. NAME: **First Aid**
COST: 1 SP
TYPE: Anytime
OBJECT: 1 character
DESCRIPTION: Heals minor battle wounds, restoring 8 Hit Points to that character.
5. NAME: **Light**
COST: 1 SP
TYPE: Non-combat
OBJECT: Entire party
DESCRIPTION: Gives the party 1 light factor, which is sufficient to light up 1 dark area. Multiple light spells can be cast to accumulate multiple light factors.
6. NAME: **Power Cure**
COST: 1/L+1 **Gem**
TYPE: Anytime
OBJECT: 1 character
DESCRIPTION: Restores character's health and 1-10 Hit Points per experience level of caster.
7. NAME: **Turn Undead**
COST: 1 SP
TYPE: Combat
OBJECT: All undead monsters
DESCRIPTION: Destroys some or all undead monsters, depending on caster's experience level and monster's power level.

Clerical Spells

Level 2

1. NAME: **Cure Wounds**
COST: 2 SP
TYPE: Anytime
OBJECT: 1 character
DESCRIPTION: Cures more serious wounds, restoring 15 Hit Points to the character.
2. NAME: **Heroism**
COST: 2 SP+1 Gem
TYPE: Combat
OBJECT: 1 character
DESCRIPTION: Temporarily elevates a character 6 levels of experience. Spell lasts for the duration of combat.
3. NAME: **Nature's Gate**
COST: 2 SP
TYPE: Non-combat, Outside
OBJECT: Entire party
DESCRIPTION: Using the forces of nature, opens a portal between two locations in the land of Cron. These locations vary with time (days/years).
4. NAME: **Pain**
COST: 2 SP
TYPE: Combat
OBJECT: 1 monster, not undead
DESCRIPTION: Cripples monster with pain, inflicting 2-16 damage points, unless the monster is immune to pain.
5. NAME: **Protection From Elements**
COST: 2 SP+1 Gem
TYPE: Anytime
OBJECT: Entire party
DESCRIPTION: Increases all character's resistance to fear, cold, fire, poison, acid and electricity. Amount of the increase depends on the caster's experience level. Spell lasts 1 day.
6. NAME: **Silence**
COST: 2 SP
TYPE: Combat
OBJECT: 4 monsters +1 per level
DESCRIPTION: Prevents the monsters from casting spells for the duration of combat, or until they overcome the spell.
7. NAME: **Weaken**
COST: 2 SP+1 Gem
TYPE: Combat
OBJECT: 10 monsters
DESCRIPTION: Weakens all monsters affected, reducing their physical damage by half until the spell is overcome.

Clerical Spells

Level 3

1. NAME: **Cold Ray**
COST: 3 SP+2 **Gems**
TYPE: Combat, not in hand to hand
OBJECT: 5 monsters
DESCRIPTION: Attacks with a ray of intensive cold that penetrates to the monsters heart and inflicts 25 points of damage to each monster affected.
2. NAME: **Create Food**
COST: 3 SP+2 **Gems**
TYPE: Non-combat
OBJECT: Spell caster
DESCRIPTION: Adds 8 food units to caster's food supply. Caster may then distribute food among other party members, if he/she desires.
3. NAME: **Cure Poison**
COST: 3 SP
TYPE: Anytime
OBJECT: 1 character
DESCRIPTION: Flushes poison out of a character's system, instantaneously removing the poisoned condition.
4. NAME: **Immobilize**
COST: 3 SP
TYPE: Combat
OBJECT: 5 monsters
DESCRIPTION: Immobilizes any monster affected.
5. NAME: **Lasting Light**
COST: 3 SP
TYPE: Non-combat
OBJECT: Entire party
DESCRIPTION: Bestows 20 light factors on the party, for use in dispelling darkness.
6. NAME: **Walk on Water**
COST: 3 SP+2 **Gems**
TYPE: Non-combat, Outdoor
OBJECT: Entire party
DESCRIPTION: Creates a floating sand dune upon which the party may walk on. Lasts 1 day.

Clerical Spells

Level 4

1. NAME: **Acid Spray**
COST: 4 SP+**3 Gems**
TYPE: Combat, not in hand to hand
OBJECT: 3 monsters
DESCRIPTION: Sprays a corrosive stream of acid inflicting 6-60 points of damage, unless immune to acid.
2. NAME: **Air Transmutation**
COST: 4 SP+**3 Gems**
TYPE: Non-combat, Outdoor
OBJECT: Entire party
DESCRIPTION: Transforms the party into air, allowing the exploration of the elemental plane of air.
3. NAME: **Cure Disease**
COST: 4 SP
TYPE: Anytime
OBJECT: 1 character
DESCRIPTION: Restores full health to sick character, instantaneously removing the diseased condition.
4. NAME: **Restore Alignment**
COST: 4 SP+**3 Gems**
TYPE: Non-combat
OBJECT: 1 character
DESCRIPTION: Restores a character's original alignment, after actions and responses have caused it to shift.
5. NAME: **Surface**
COST: 4 SP
TYPE: Non-combat
OBJECT: Entire party
DESCRIPTION: Instantly transports all party members from an underground location to grounds surface.
6. NAME: **Holy Bonus**
COST: 4 SP+**3 Gems**
TYPE: Combat
OBJECT: Entire party
DESCRIPTION: The generous forces of the cleric's deity increase the damage done by party members by 1 point per 2 levels of the caster.

Clerical Spells

Level 5

1. NAME: **Air Encasement**
COST: 5 SP+5 Gems
TYPE: Combat
OBJECT: 1 monster
DESCRIPTION: Encases the target in a field of air, inflicting 10 points of damage per combat round and separating it from the battle until the spell is overcome or the monster is attacked.
2. NAME: **Deadly Swarm**
COST: 5 SP+5 Gems
TYPE: Combat
OBJECT: 10 monsters
DESCRIPTION: Sends a swarm of killer insects against the monsters, inflicting 4-40 damage points against each monster.
3. NAME: **Frenzy**
COST: 5 SP+5 Gems
TYPE: Combat
OBJECT: 1 character, once per character
DESCRIPTION: Sends one party member into a frenzy, allowing him/her to attack all the monsters on the screen. Drained from the experience, the character loses 1 point of endurance and is then rendered unconscious.
4. NAME: **Paralyze**
COST: 5 SP+5 Gems
TYPE: Combat
OBJECT: 10 monsters
DESCRIPTION: Attempts to immobilize all monsters and prevent them from fighting. May be partially or completely effective on some or all monsters.
5. NAME: **Remove Condition**
COST: 5 SP+5 Gems
TYPE: Anytime
OBJECT: 1 character
DESCRIPTION: Releases character from all undesirable conditions except dead, stoned or eradicated.

Clerical Spells

Level 6

1. NAME: **Earth Transmutatuion**
COST: 6 SP+6 **Gems**
TYPE: Non-combat, outdoor
OBJECT: Entire party
DESCRIPTION: Transforms the party into earth, allowing the exploration of the elemental plane of earth.
2. NAME: **Rejuvenate**
COST: 6 SP+6 **Gems**
TYPE: Non-combat
OBJECT: 1 character
DESCRIPTION: A fountain of youth that trims 1-10 years off a character's age, restoring his/her abilities to the younger level. Spell carries some risk of producing the opposite effect.
3. NAME: **Stone to Flesh**
COST: 6 SP+6 **Gems**
TYPE: Anytime
OBJECT: 1 character
DESCRIPTION: Re-animates a character who has been turned to stone, removing the stoned condition.
4. NAME: **Water Encasement**
COST: 6 SP+6 **Gems**
TYPE: Combat
OBJECT: 1 monster
DESCRIPTION: Encases the target in a field of water, inflicting 20 points of damage per combat round and separating it from the battle until the spell is overcome or the monster is attacked.
5. NAME: **Water Transmutation**
COST: 6 SP+6 **Gems**
TYPE: Non-combat, outdoor
OBJECT: Entire party
DESCRIPTION: Transforms the party into water, allowing the exploration of the elemental plane of water.

Clerical Spells

Level 7

1. NAME: **Earth Encasement**

COST: 7 SP+7 **Gems**

TYPE: Combat

OBJECT: 1 monster

DESCRIPTION: Encases the target in a field of earth, inflicting 40 points of damage per combat round and separating it from the battle until the spell is overcome or the monster is attacked.

2. NAME: **Fiery Flail**

COST: 7 SP+7 **Gems**

TYPE: Combat

OBJECT: 1 monster

DESCRIPTION: Creates a huge flail of fire, striking a single opponent, inflicting 100-400 points of damage.

3. NAME: **Moon Ray**

COST: 7 SP+7 **Gems**

TYPE: Combat, outdoors

OBJECT: 10 monsters

DESCRIPTION: Bathes all combatants in a beneficent ray that bestows 10-100 Hit Points on each character and removes 10-100 Hit Points from each monster.

4. NAME: **Raise Dead**

COST: 7 SP+7 **Gems**

TYPE: Anytime

OBJECT: 1 character

DESCRIPTION: Brings the character back to life, removing the dead condition. Spell carries a moderate chance of failure and a remote chance of eradicating the character. (Note: Spell-caster and recipient age by 1 year.)

Clerical Spells

Level 8

1. NAME: **Fire Encasement**
COST: 8 SP+8 Gems
TYPE: Combat
OBJECT: 1 monster
DESCRIPTION: Encases the target in a field of fire, inflicting 80 points of damage per combat round and separating it from the battle until the spell is overcome or the monster is attacked.
2. NAME: **Fire Transmutation**
COST: 8 SP+8 Gems
TYPE: Non-combat, outdoors
OBJECT: Entire party
DESCRIPTION: Transforms the party into fire, allowing the exploration of the elemental plane of fire.
3. NAME: **Mass Distortion**
COST: 8 SP+8 Gems
TYPE: Combat
OBJECT: 2 monsters
DISCRIPTION: Increases the weight of monsters causing them to fall and subsequently lose half their hit points.
4. NAME: **Town Portal**
COST: 8 SP+8 Gems
TYPE: Non-combat
OBJECT: Entire party
DISCRIPTION: Opens a temporary portal to any town and moves the party through the portal to that town.

Clerical Spells

Level 9

1. NAME: **Divine Intervention**
COST: 10 SP+**20 Gems**
TYPE: Combat
OBJECT: Entire party
DESCRIPTION: Intercedes with supernatural forces to restore all characters' Hit Points and remove all undesirable conditions, except eradicated.
(Note: Spell-caster ages 5 years every time this spell is cast.)
2. NAME: **Holy Word**
COST: 10 SP+**10 Gems**
TYPE: Combat
OBJECT: All
DESCRIPTION: Utters a single word of devastating power, that destroys all undead monsters.
(Note: Ages caster 1 year.)
3. NAME: **Resurrection**
COST: 10 SP+**10 Gems**
TYPE: Non-combat
OBJECT: 1 character
DESCRIPTION: Removes the eradicated condition from the character, adding 5 years to his/her age and subtracting 1 endurance point from his/her vital statistics. There is a chance that the spell will fail.
(Note: Ages caster 1 year.)
4. NAME: **Uncurse Item**
COST: 10 SP+**50 Gems**
TYPE: Non-combat
OBJECT: Spell caster
DESCRIPTION: Attempts to remove the curse from an item in casters backpack.

Sorcerer Spells

Level 1

1. NAME: **Awaken**
COST: 1 SP
TYPE: Anytime
OBJECT: All sleeping party members
DESCRIPTION: Awakens all sleeping members of the party, instantaneously cancelling the sleep condition. May be critical if party is attacked during rest.
2. NAME: **Detect Magic**
COST: 1 SP
TYPE: Non-combat
OBJECT: Items in spell casters backpack
DESCRIPTION: Reveals any magical items in caster's backpack, and notes the number of magical charges remaining in any item which must be charged for use. Also detects any magic surrounding or inside a chest.
3. NAME: **Energy Blast**
COST: 1/L+1 **Gem**
TYPE: Combat
OBJECT: 1 monster
DESCRIPTION: Zaps the monster with a blast of pure energy, inflicting 1-6 damage points per experience level of caster.
4. NAME: **Flame Arrow**
COST: 1 SP
TYPE: Combat
OBJECT: 1 monster
DESCRIPTION: Sends a burning shaft into the monster, inflicting 2-8 points of fire damage, unless monster is immune to fire.
5. NAME: **Light**
COST: 1 SP
TYPE: Non-combat
OBJECT: Entire party
DESCRIPTION: Gives the party 1 light factor, sufficient to light a single darkened square. Multiple light spells can be cast, to accumulate light factors.
6. NAME: **Location**
COST: 1 SP
TYPE: Non-combat
OBJECT: Entire party
DESCRIPTION: Gives precise information on party's location. Shows a map of the current 16x16 area that the party has mapped and shows your present location on that map. May be critical when party is lost or magically transported. In general, this spell is the key to successful mapping.
7. NAME: **Sleep**
COST: 1 SP
TYPE: Combat
OBJECT: 4 monsters +1 monster/L of caster
DESCRIPTION: Sends monsters into a deep sleep, preventing them from attacking. Effective until monster is damaged or overcomes the spell.

Sorcerer Spells

Level 2

1. NAME: **Eagle Eye**
COST: 2/L
TYPE: Non-combat, outdoor
OBJECT: 5 steps per level of caster
DESCRIPTION: An eagle eye view of the outdoor terrain appears on the screen, providing a 5x5 overhead view of the area and your party's location.
2. NAME: **Electric Arrow**
COST: 2 SP
TYPE: Combat
OBJECT: 1 monster
DESCRIPTION: Electrocutates a monster, inflicting 4-16 damage points, unless monster is immune to electrical attack.
3. NAME: **Identify Monster**
COST: 2 SP+1 Gem
TYPE: Combat
OBJECT: 1 monster
DESCRIPTION: Informs caster of the current condition of any one monster during combat.
4. NAME: **Jump**
COST: 2 SP
TYPE: Non-combat
OBJECT: Entire party
DESCRIPTION: Moves the party 2 squares forward, providing there are no magical obstructions (force fields, etc.) in the way.
5. NAME: **Levitate**
COST: 2 SP
TYPE: Non-combat
OBJECT: Entire party
DESCRIPTION: Raises all characters above ground level, protecting them from various dangers for 1 day.
6. NAME: **Lloyd's Beacon**
COST: 2 SP+1 Gem
TYPE: Non-combat, Dungeon
OBJECT: Entire party
DESCRIPTION: Leaves a beacon at your current location so that you may instantaneously return to that location the next time you cast this spell.
7. NAME: **Protection from Magic**
COST: 1/L+1 Gem
TYPE: Anytime
OBJECT: Entire party
DESCRIPTION: Increases all characters' resistance to magic. Amount of the increase depends on experience level of caster. Spell lasts 1 day.

Sorcerer Spells

Level 3

1. NAME: **Acid Stream**

COST: 1/L+2 **Gems**

TYPE: Combat

OBJECT: 1 monster

DESCRIPTION: Sprays a burning stream of acid inflicting 2-8 points of damage per level of caster, unless immune to acid.

2. NAME: **Fly**

COST: 3 SP

TYPE: Non-combat, Outdoors

OBJECT: Entire party

DESCRIPTION: Grants magical flight to all characters, allowing the party as a whole to move to any other outdoor area. The party will land in the safest square in that area.

3. NAME: **Invisibility**

COST: 3 SP

TYPE: Combat

OBJECT: Entire party

DESCRIPTION: Drops a cloak of invisibility over all characters, greatly decreasing the monsters' chances of hitting them.

4. NAME: **Lightning Bolt**

COST: 1/L+2 **Gems**

TYPE: Combat

OBJECT: 4 monsters

DESCRIPTION: Blasts the monsters with a gigantic lightning bolt that inflicts 1-6 damage points per level of caster.

5. NAME: **Web**

COST: 3 SP+2 **Gems**

TYPE: Combat, not in hand to hand

OBJECT: 4 monsters +1 monster/L of caster

DESCRIPTION: Wraps monsters in a supernatural web, preventing them from fighting for the duration of combat or until they escape.

6. NAME: **Wizard Eye**

COST: 3/L+2 **Gems**

TYPE: Non-combat, indoors

OBJECT: 5 steps per level of caster

DESCRIPTION: Uses the magical eye of a powerful wizard to show a 5x5 overhead view of your party's location in any indoor maze.

Sorcerer Spells

Level 4

1. NAME: **Cold Beam**
COST: 1/L+3 **Gems**
TYPE: Combat
OBJECT: 1 monster
DESCRIPTION: Attacks with a beam of intense cold that penetrates to the monster's heart and inflicts 6 damage point per level of caster, unless the monster is immune to cold.
2. NAME: **Feeble Mind**
COST: 4 SP+3 **Gems**
TYPE: Combat
OBJECT: 5 monsters
DESCRIPTION: Erases the monsters brain, removing all its abilities for the duration of combat or until the monster overcomes the spell.
3. NAME: **Fire Ball**
COST: 1/L+3 **Gems**
TYPE: Combat, not in hand to hand
OBJECT: 6 monsters
DESCRIPTION: Rolls a deadly ball of fire into the monsters' midst, inflicting 1-6 damage points per level of caster.
4. NAME: **Guard Dog**
COST: 4 SP
TYPE: Non-combat
OBJECT: Entire party
DESCRIPTION: Places a supernatural guard over party, preventing surprise attacks for 1 day.
5. NAME: **Shield**
COST: 4 SP
TYPE: Combat
OBJECT: Entire party
DESCRIPTION: Creates an invisible shield which surrounds the party and protects all characters from most missile weapons for the duration of combat.
6. NAME: **Time Distortion**
COST: 4 SP+3 **Gems**
TYPE: Combat
OBJECT: Entire party
DESCRIPTION: Creates a warp in time that enables the party to retreat safely from most battles.

Sorcerer Spells

Level 5

1. NAME: **Disrupt**
COST: 5 SP+5 **Gems**
TYPE: Combat, not in hand to hand
OBJECT: 1 monster
DESCRIPTION: Creates a powerful energy field that disrupts the molecular bonds of the target, inflicting 100 points of damage.
2. NAME: **Fingers of Death**
COST: 5 SP+5 **Gems**
TYPE: Combat
OBJECT: 3 monsters (not undead)
DESCRIPTION: Channels the ancient power of all dead sorcerers through the caster, resulting in death to the monsters at whom the caster points a finger.
3. NAME: **Sand Storm**
COST: 2/L+5 **Gems**
TYPE: Combat, outdoors
OBJECT: 10 monsters
DESCRIPTION: Calls upon the forces of nature to create a violent sand storm inflicting 1-8 points of damage per level of caster.
4. NAME: **Shelter**
COST: 5 SP
TYPE: Non-combat
OBJECT: Entire party
DESCRIPTION: Provides 1 day's rest free of the danger of encounter.
5. NAME: **Teleport**
COST: 5 SP
TYPE: Non-combat
OBJECT: Entire party
DESCRIPTION: Instantly moves the party from its present position, up to 9 squares in any direction.

Sorcerer Spells

Level 6

1. NAME: **Disintegration**
COST: 6 SP+6 **Gems**
TYPE: Combat
OBJECT: 3 monsters
DESCRIPTION: Inflicts 50 damage points while disintegrating parts or all of the target.
2. NAME: **Entrapment**
COST: 6 SP+6 **Gems**
TYPE: Combat
OBJECT: All
DESCRIPTION: Surrounds the battle with a magical energy field preventing all from escaping.
3. NAME: **Fantastic Freeze**
COST: 2/L+6 **Gems**
TYPE: Combat, not in hand to hand
OBJECT: 3 monsters
DESCRIPTION: Shoots a fantastic beam of cold at 3 monsters, crystalizing them and inflicting 10 damage points per level of caster.
4. NAME: **Recharge Item**
COST: 6 SP+6 **Gems**
TYPE: Non-combat
OBJECT: Spell caster
DESCRIPTION: Restores 1-6 charges to any item in caster's backpack that still has 1 magical charge remaining. Some risk that the spell will fail and destroy the item.
5. NAME: **Super Shock**
CAST: 2/L+6 **Gems**
TYPE: Combat
OBJECT: 1 monster
DESCRIPTION: Shoots an intense beam of electricity, shocking a monster with 20 damage points per level of caster.

Sorcerer Spells

Level 7

1. NAME: **Dancing Sword**
COST: 3/L+7 **Gems**
TYPE: Combat
OBJECT: 10 monsters
DESCRIPTION: A magical sword that moves with lightning speed and inflicts 1-12 damage points per level of caster.
2. NAME: **Duplication**
COST: 7 SP+100 **Gems**
TYPE: Non-combat
OBJECT: Spell caster
DESCRIPTION: Allows the caster to exactly duplicate any 1 item in his/her backpack, provided that there is room in the caster's pack for the new item. Small chance that the spell will fail and destroy the original item.
3. NAME: **Etherealize**
COST: 7 SP+7 **Gems**
TYPE: Non-combat
OBJECT: Entire party
DESCRIPTION: Alters all characters' molecular structure long enough to allow them to move 1 square forward through any barrier (force field, wall, mountain, etc.).
4. NAME: **Prismatic Light**
COST: 7 SP+7 **Gems**
TYPE: Combat
OBJECT: 10 monsters
DESCRIPTION: A powerful, but erratic spell that has completely unpredictable effects.

Sorcerer Spells

Level 8

1. NAME: **Incinerate**
COST: 3/L+**8 Gems**
TYPE: Combat
OBJECT: 1 monster
DESCRIPTION: Engulfs a monster with the heat of a thousand fires doing 20-40 damage points per level of caster.
2. NAME: **Mega Volts**
COST: 3/L+**8 Gems**
TYPE: Combat
OBJECT: 10 monsters
DESCRIPTION: Creates a chain of electricity connecting all opponents with the deadly voltage doing 4-16 damage points per level of caster.
3. NAME: **Meteor Shower**
COST: 8+1 per monster+**8 Gems**
TYPE: Combat, Outdoors
OBJECT: All (limited by spell points)
DESCRIPTION: Buries all monsters under a hail of meteors, inflicting 5-50 damage points on each monster.
4. NAME: **Power Shield**
COST: 8 SP+**8 Gems**
TYPE: Combat
OBJECT: Entire party
DESCRIPTION: Reduces the damage inflicted on all characters by any attack, by 1/2. Lasts for the duration of combat.

Sorcerer Spells

Level 9

1. NAME: **Implosion**
COST: 10 SP+**10 Gems**
TYPE: Combat
OBJECT: 1 monster
DESCRIPTION: Creates a hole in space, at the center of the target creature, sucking it into nothingness.

2. NAME: **Inferno**
COST: 3/L+**10 Gems**
TYPE: Combat
OBJECT: 10 monsters
DESCRIPTION: Unleashes the heat of the sun on all monsters shown, doing 1-20 points damage per level of caster.

3. NAME: **Star Burst**
COST: 10+1 per monster+**20 Gems**
TYPE: Combat, outdoor
OBJECT: All (limited by spell points)
DESCRIPTION: Showers all monsters with pieces of an exploding star, doing 20-200 points of damage.

4. NAME: **Enchant Item**
COST: 50 per plus of item+**50 Gems**
TYPE: Non-combat
OBJECT: Spell caster
DESCRIPTION: Attempts to raise the magic ability of an item by increasing it's '+' by 1.

Example of Town 1-Middlegate

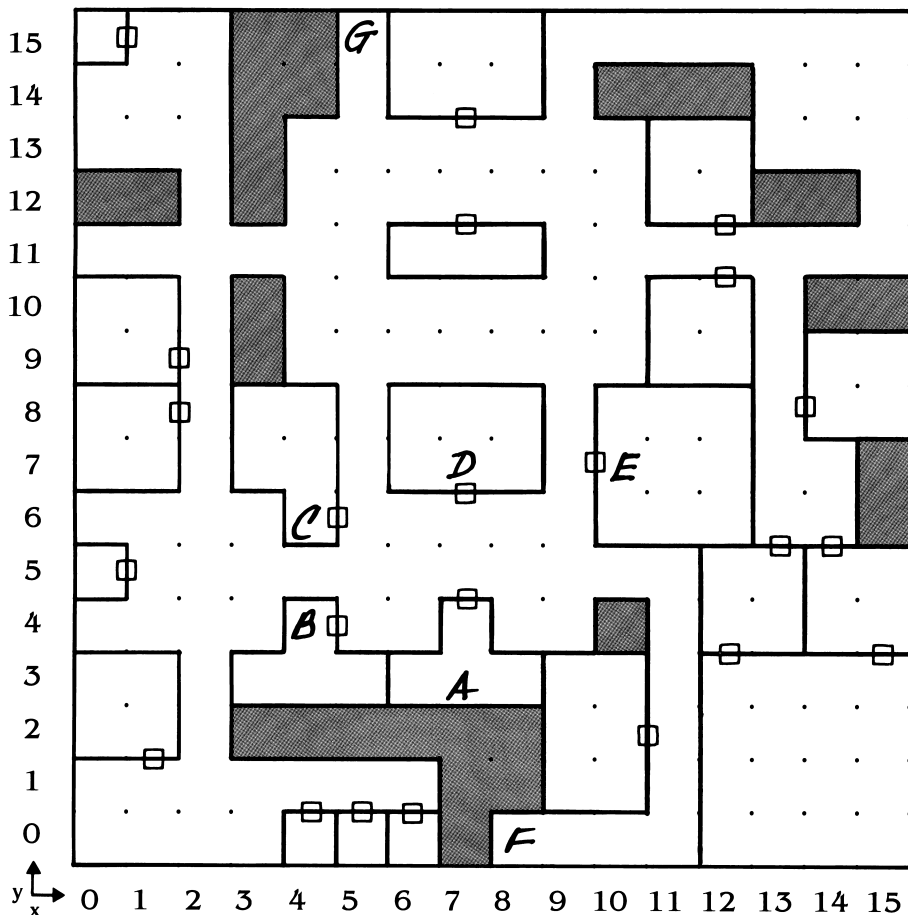

Area: Town # 1 - Middlegate Map sector C-2

Surface X = 7, Y = 3

- Notes: A—Middlegate Inn - sign in to save characters/game
 B—S.J. Blacksmith - buy/sell items
 C—Slaughtered Lamb Tavern - buy food/hear rumors
 D—Gateway Temple - clerical help
 E—Turkov's Training Grounds - increase skills
 F—Passage to natural caverns
 G—Town Exit

Might and Magic® II

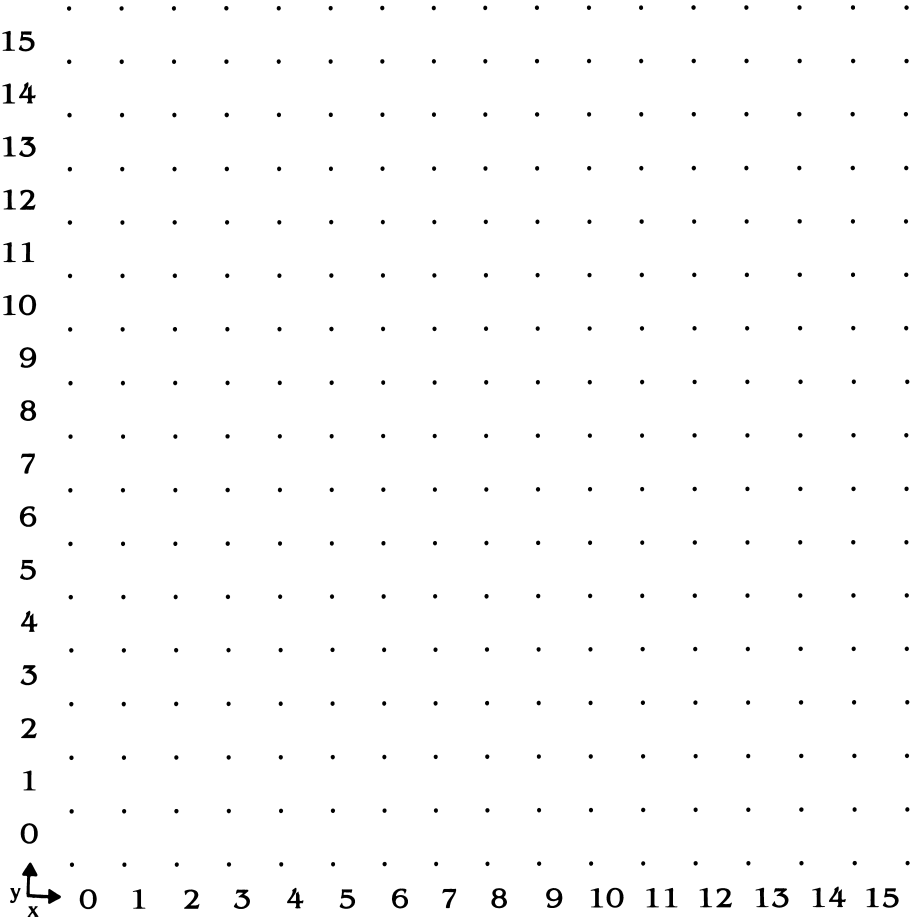

KEY:

Area:

Notes:

Might and Magic® II

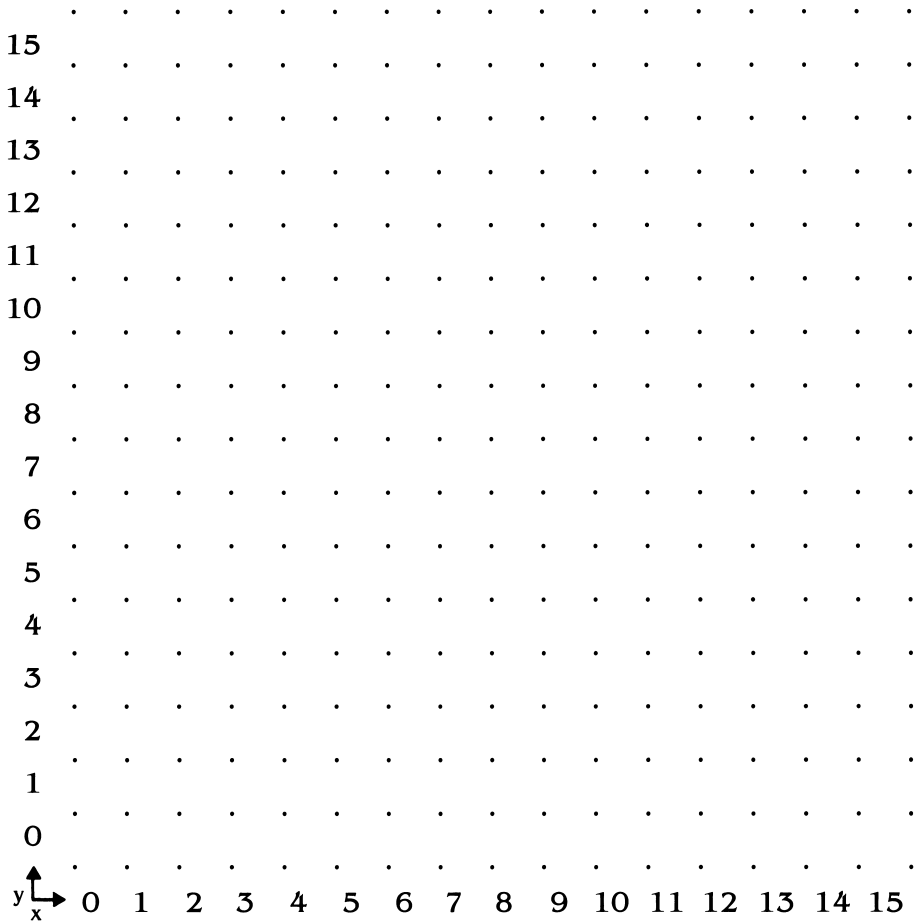

KEY:

Area:

Notes:

Might and Magic® II

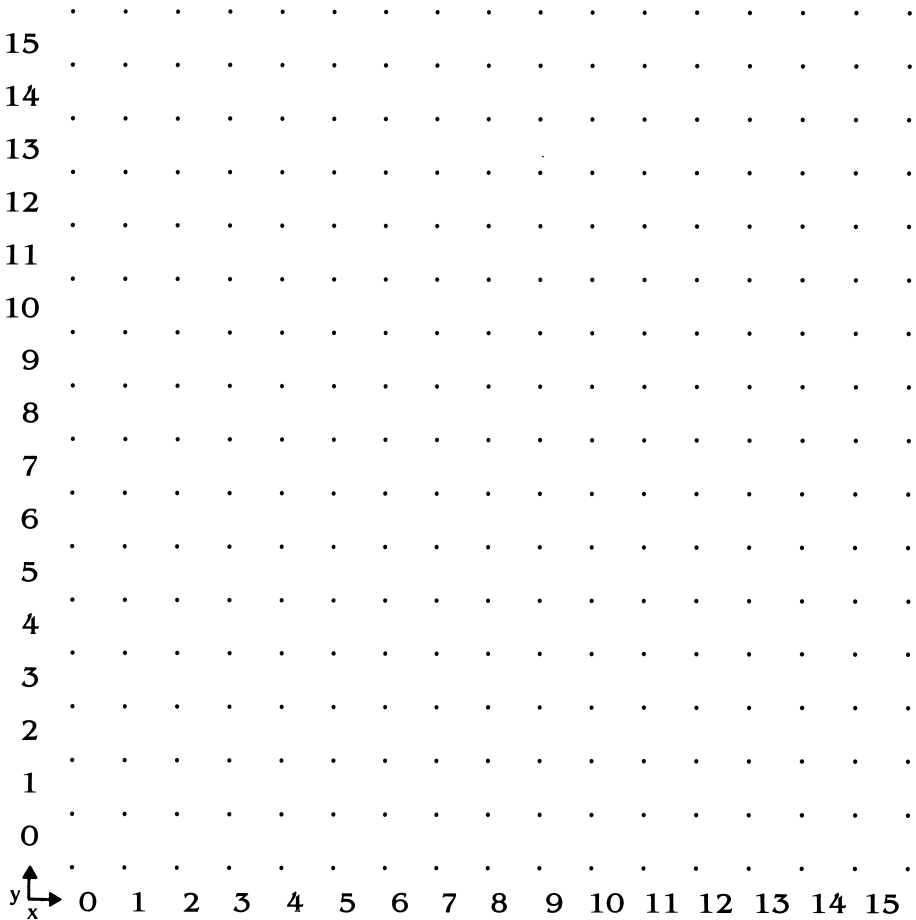

KEY:

Area:

Notes:

Special Instructions for the Apple® II Family of Computers

Compatibility

Might and Magic® II runs on any Apple® IIc, IIe, IIGs or compatible with at least 128k of RAM. The sophisticated animation of Might and Magic® II requires that your computer have the ability to run Double Hi-Res graphics.

Copying Disks

Before getting started you must copy Side B on to a non-write protected (notched) 5 1/4" disk. This enables you to save your party when signing into an Inn.

If you do not copy Side B on to a notched disk, you will not be able to save your characters when signing into an Inn.

Use the Copy Disks feature in the Opening Options Menu or an equivalent copy utility for this purpose.

Note- It is recommended, but not required, that you also make copies of sides C, D, E, and F, which are used extensively throughout the course of the game. Side A is copy protected and will not function properly if copied.

Getting Started

To begin playing Might and Magic®, place Disk A into Drive 1 and turn the computer ON.

Opening Options Menu

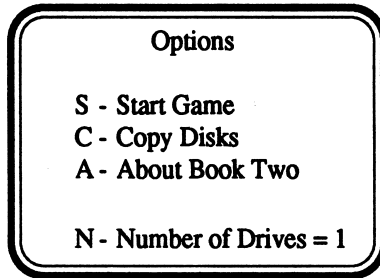

A - About Book Two

In the Apple® II version, the Demo option shown in the manual has been replaced by **About Book Two**. Press A to view the creators of Book Two, as well as the version number. Press <Return> to get back to the Opening Options Menu.

N - Number of Drives

Game play can be enhanced if you have two 5 1/4" Disk drives. Press N to select 1 or 2 drives. This eliminates some inconvenient disk swapping during game play and while using the Copy Disks Option.

Main Options Menu

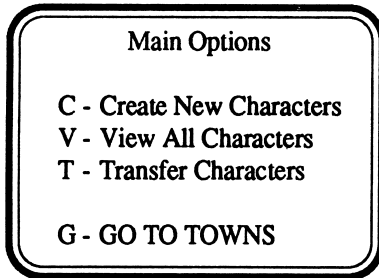

T - Transfer Characters

Before transferring **Might and Magic®**, Book One characters, make a copy of Book One, side B, to ensure that no harm comes to your old characters.

Note- As stated in the manual, all current Book Two characters will be eliminated during transfer. So, if you intend to create new characters AND transfer old characters, perform the transfer first.

Shopping Hints

When browsing in any of the shops in the five towns, be aware that the following abbreviations have been made:

I - Iron
S - Silver
k - 1000

B - Bronze
G - Gold

So an item listed as:

G Ring Mail - 20k

is **Gold Ring Mail** for the low, low price of **20,000 Gold**. *Caveat Emptor*.

A dash next to an item indicates that that item is unusable by the current character.

3 1/2" Disk and Hard Drive Users

Due to incompatible formats, we are unable to support 3 1/2" disks or hard drives for the **Apple® II Series** at this time.

Playing Tips

Be aware that messages and events can be based on days, years and centuries. So, an encounter that happens on Day 35, may or may not happen on Day 36. After long clues or messages, press any key to continue.

If you think that you are getting killed to often try changing your party's disposition to inconspicuous. To do this, refer to page 19 of the manual, **Game Commands While Marching**, **CONTROLS**.

Remember to equip weapons and armor. If you get a *****Backpack Full***** message, you must immediately drop an unwanted item and search to receive the new item(s).

Need Help in Your Adventures?

Might and Magic got you stumped?

Did you buy **Might and Magic II** and then decide to wait for the hintbook?

Worry no more! Adventuring has just become easier with the hintbooks to **Might and Magic I** and **Might and Magic II**.

Adventurer's Guide to Might and Magic: Book One

- 55 complete and detailed maps
- Coded hints, providing hints on a need-to-know basis
- All the clues and hints needed to win the game

Might and Magic II Cluebook: Corak's Travelogue

- 60 complete and detailed maps, including 5 in-depth town maps
- All the clues and hints necessary to play the game
- All new, special features, including a complete monster list

Order Now!

- Visit your local retailer and ask for the book you need
- Call (818) 785-0519 between 10am and 4pm (PST) for Visa/MC orders only
- Or send in this handy order form to:

AP2

New World Computing
P.O. Box 2068
Van Nuys, CA 91404

Adventurer's Guide To Might and Magic I

_____ books @ \$12.95 each

Might and Magic II Cluebook

_____ books @ \$12.95 each

(Might and Magic II Cluebook available in June 1989)

subtotal: _____

CA residents add 6.5% tax: _____

Add \$1.00 shipping and handling per book: _____

Total: _____

- Pay by check, money order (U.S. funds only), or Visa/MC

Cardholder Name (please print): _____

Visa/MC #(circle one): _____ Exp. Date: _____

Signature: _____

Ship to: Name: _____

Address: _____

City/State/Zip: _____

Telephone #: (_____) _____

Allow 2-6 weeks for delivery.

Place
Stamp
Here

New World Computing, Inc.
Attn: Customer Service
P.O. Box 2068
Van Nuys, CA 91404

New World Computing

Product Registration Card

Name _____ Age _____

Address _____

City _____ State _____ Zip _____

Phone (____) _____ Computer Model _____

Program Purchased _____ Date Purchased _____

Where Purchased:

- Computer Store
- Software Store
- Department Store
- Toy/Hobby Store
- Mail Order
- Received as a gift
- Other _____

How did you hear about this product?

- Magazine Review
- Magazine Ad
- Store Personnel
- A Friend
- Other _____

What Computer/Software magazines do you read regularly?
