

Solutions
to over
40 MORE
best-selling
games!

QUEST QUEST II

FOR

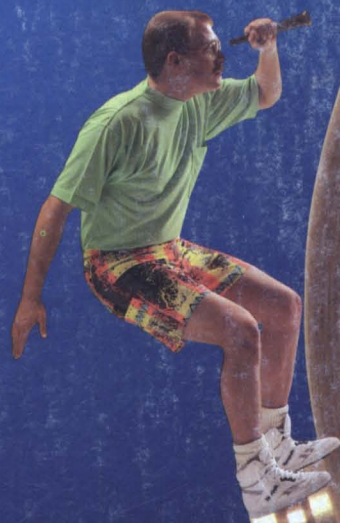

Edited by
Shay Addams

FOR THE

FOR THE

All rights reserved. No part of this publication may be reproduced, stored in a retrieval system, or transmitted in any form or by any means, electronic, mechanical, photocopying, recording, or by any information storage and retrieval system, without permission in writing from the publisher.

Copyright © 1999

Published by [illegible]



All rights reserved. No part of this book
may be reproduced, in any form or by any means,
without permission in writing from the publisher.

ISBN 0-929373-01-4

Copyright © 1989 by Shay Addams

Dedication

For Barbara and Mark

The Quest Buster's CODE

Use this table to de-
code clues. To
make this process more
convenient, photocopy
it and place it beside
the coded sections.

b = a	k = j	t = s
c = b	l = k	u = t
d = c	m = l	v = u
e = d	n = m	w = v
f = e	o = n	x = w
g = f	p = o	y = x
h = g	q = p	z = y
i = h	r = q	a = z
j = i	s = r	

(Origin Systems hereby authorizes you to photocopy this page, and no other portion of this book, exclusively for this purpose.)

QuestBusters™ - Free!

For a FREE three-month subscription to *QuestBusters, The Adventurers Journal*, just fill out *this* coupon (not a photocopy) and send it to the address below. Each issue contains extensive walkthroughs to recent games, in-depth reviews, Bug Reports and the Adventure Hot Line's news on upcoming adventures and conversions. Send payment with coupon and get \$5.00 worth of back issues (your choice) free! This offer is for new subscriptions only, and cannot be used to renew an existing subscription or in conjunction with any other offer.

(Please Print)

Name _____

Street _____

City _____ State _____ Zip _____

- Yes, send my FREE three-month subscription.
- Yes, I have also enclosed \$18 (Canada \$24, Overseas \$32 - U.S. Funds) for a 12-issue subscription — and my three free issues!
- Make that \$24 and send my subscription Adventure Express — mailed First Class in a "Kevlar-plated" envelope (to U.S. addresses only; recommended for APO/FPO addresses).

Send to QuestBusters, P.O. Box 5845, Tucson, AZ 85703. Checks or money orders should be made payable to QuestBusters. (QuestBusters is an independent publication unaffiliated with any software company.)

Quest for Clues II

the Table of Contents

Quest Code	iv
Table of Contents.....	1
QuestBusters Guild.....	2
How to Use This Book.....	3

Text/Graphic

Adventures.....	4
Azarok's Tomb.....	5
Beyond Zork.....	7
Dark Lord.....	10
Déja Vu.....	13
Dondra: A New Beginning.....	16
Dr. Dumont's Wild P.A.R.T.I.	18
Dream Zone.....	21
Guild of Thieves.....	24
Jinxter.....	27
King's Quest IV.....	30
Leisure Suit Larry I.....	35
Leisure Suit Larry II.....	37
Manhunter: New York.....	41
Maniac Mansion.....	46
Plundered Hearts.....	49
Police Quest I.....	51
Sherlock Holmes and the Riddle of the Crown Jewels.....	54

Space Quest II.....	57
Talisman.....	60
The Twilight Zone.....	63
Uninvited.....	66
Zak McKracken and the Alien Mindbenders.....	69
Role Playing Games.....	75
2400 A.D.	76
Advanced Dungeons and Dragons.....	83
Alien Mind.....	94
The Bard's Tale III.....	98
The Colony.....	106
The Eternal Dagger.....	111
Faery Tale Adventure.....	118
Quarterstaff: The Tomb of Setmoth.....	121
Questron II.....	125
Return to Atlantis.....	129
Seven Spirits of Ra.....	131
Star Command.....	134
Tangled Tales.....	139
Times of Lore.....	146
Tower of Myraglen.....	149
Ultima V: Warriors of Destiny.....	152
Wasteland.....	162
Willow.....	171
Wizardry IV: Return of Werdna.....	173
Game Manufacturers.....	181

The QuestBusters Guild

Steven Payne: *The Colony, Dr. Dumont's Wild P.A.R.T.I., Quarterstaff*

Terry Calderwood: *King's Quest IV, Manhunter, Leisure Suit Larry II*

David Heidt: *Star Command, Police Quest, Space Quest II*

William E. Carte: *Azarok's Tomb, Alien Mind*

Brian Smith: *Dark Lord, Bard's Tale III*

Edgar Bork: *Déja Vu, Uninvited*

Frank Evangelista: *Wizardry IV, Ultima V*

Paul Shaffer: *Return to Atlantis, Jinxter*

John Pontaoe: *Leisure Suit Larry I, Wasteland*

J. Douglas Wellington: *Dream Zone, Tower of Myraglen*

Stephen King: *Willow*

Jon Champlin: *Talisman*

Eric Mitchell and Thomas Zybd: *The Eternal Dagger*

William Gustafson: *Faery Tale Adventure*

Carl Muckenhaupt: *Sherlock Holmes*

Allen Reinwasser: *Space Quest I*

Brian Riggs: *2400 A. D.*

Bruce A. Smith: *Dondra*

Joshua Mandell: *7 Spirits of Ra*

Randy Sluganski: *Questron II*

Andrew Phang: *Guild of Thieves*

Marc Manderino: *Plundered Hearts*

Jerry Dattilo: *Maniac Mansion*

Thomas Zybd, Richard Rasmussen, Danny Peterson: *A D & D: The Pool of Radiance*

Keith Gossage: *Zak McKracken*

The QuestBusters Guild is a league of lionhearted adventurers who don't quit after saving the land from Evil Wizards, or rescuing civilizations from time-travelling bands of Drip-dry Dragons. Instead, they share their many experiences with other adventurers by preparing complete solutions and maps that will enable others to get past the puzzles and monsters that have them stymied. This book would never have been possible without the contributions of the following members of the Guild. (Members also get the game of their choice for each solution, so write to QuestBusters if you've solved a recently released game.)

We also want to recognize the QuestBusters who verified these solutions (or whose solutions and maps were used to do so): Stephen King, William E. Carte, Larry Helsey, Linda Brooks, George R. Jenson, Bruce and Peggy Wiley, J. Douglas Wellington, Ken St. André, Paul Shaffer, Michael Bagnall, James Mallete, Tim Snider, George Martin, and Kirk ("Captain Skippy") Hutcheon and Steve Cantrell of the ORIGIN playtest department. Also thanks to First Row Software, Inc. for the *The Twilight Zone* solution, to Origin, Inc. for the *Times of Lore* and *Tangled Tales* solution.

Tom Miller - Art Work
Marsha Meuse - Design & Layout
Lori Ogwulu - Origin Kibitzer



How To Use This Book



First, check out the map for any rooms you may have overlooked. A dotted line means you must solve a puzzle or possess a special item or knowledge in order to pass to the adjoining room, while straight lines are unobstructed. Doors are indicated with lines that run perpendicular to the walls. The location of vital objects and some events are represented by letters or numbers beside the rooms; if seeking a specific object, look it up in the Map Key. Graphic symbols representing a map's special features, such as teleportation doors, are also pointed out in the Map Keys. The maps reflect every location necessary to solve the game, but may not show every room or dungeon/maze level. (This is especially true in the maps of role-playing games like *Bard's Tale*.)



Still stuck? Proceed to the walkthrough, which is divided into a series of locations and things to do in each. First glance at the names of the locations to see a path necessary to complete the adventure. (In many cases you can figure this out by following the series of letters indicating objects.) This will ensure that you're not chasing a "red herring" in the wrong direction. In case you're stuck on a particular problem, read the answers—they're encoded so you can get a general idea of what to do but still figure it out yourself. It might say "Tpmwf the puzzle," so you have to unravel the riddle of exactly what to do with the puzzle. To decode answers, count backwards one letter: "T" becomes "S", "p" becomes "o", and so on, revealing this answer to be "Solve the puzzle." (There is usually more than one correct path to follow, and some puzzles will have alternative solutions. These walkthroughs offer just one—but one that definitely works.)



If you're looking for a new game to play, of course, don't do any of the above. The reviews will give you an overview of what each is all about and some criticism, along with a brief review.



Graphic and Text Adventures: Playing Mind Games Forever

According to the QuestBuster's Unabridged Dictionary, an adventure game is one in which the player's main activity involves solving logical puzzles (or at least *trying* to) by typing words into a parser, or by choosing commands from a menu. Within this genre of computer entertainment lie several subgenres. *Zork* is perhaps the worlds' most familiar all-text adventure, inspired by the mainframe computer game that started it all—Crowther and Woods' *Original Adventure*. A good example of a graphic adventure would be PolarWare's *Oo-topos*. When relatively few of a game's scenes are accompanied by graphics, as in *Jinxter*, it might be dubbed an "illustrated text adventure." Sierra's *King's Quest* series is the best-known variation on the animated graphic adventure, in which characters and objects move about the screen. With Infocom's introduction of graphics, the text adventure has almost vanished, and the animated games are leading the way into the Nineties.

The fantasy worlds of these adventures vary dramatically—from Sherlock Holmes' London in *The Riddle of the Crown Jewels* to *Manhunter's* New York City of the 21st Century. And the stories span a whirlwind of subjects that range from horror to humor: *Uninvited* defies you to escape a haunted house stocked with deadly ghosts, while *Zak McKracken and the Alien Mindbenders* keeps you laughing as it satirizes tabloid newspapers and their coverage of Elvis, UFOs and Bigfoot. So if you're looking for a mind game in which you can actually participate as one of the story's main characters, train your binoculars on the games in this section.

Arazok's Tomb

As an investigative reporter, you're thrilled to get a telegram about an archeologist who failed to return from a trip into Caer Arazok, the tomb of an unknown Druid priest in Scotland. Legends say Arazok lured other Druids to worship at his unholy temple, from which he often journeyed to the "nether regions of hell." While he was away on such a trip, the Druids destroyed his temple and trapped him on the other side of the gate. Inside the temple, you will find a teleport gate to that world, where you'll dis-

cover a pair of domed cities, a mist-enshrouded castle and a variety of magical gear. Graphics are excellent, especially on the Amiga, but the parser is weak, despite the convenient drop-down menus, keyboard short-cuts for most commands and the ability to scroll back to review the contents of the text window. The puzzles are below average (there's only one really tough one), so the special effects just don't compensate for the weaknesses. Not recommended.

Type: Graphic Adventure

Skill Level: Novice

Systems: Amiga, Macintosh, ST

Company: Aegis Development

The Solution

The magic candle works just a few times—so if you're using this solution to complete a saved game in which you've already used up the candle, you will have to restore a previous save.

Dense Forest

N. Examine statue. Get jewel from belt. Put jewel in eye. D. N (2). Enter circle.

Giant Forest

Get tostins (eat them when you get hungry.) (Go to Lab 1.)

Lab 1

Get book. Read book (2). Say Rezrathron (2). Drop book. N. W. U.

Warriors' Quarters

Get all. Wear mail. D. E (3).
NE (2). NW. Kill
Zud with
txpse. Get

pouch. Drop txpse. Drop mail. NW. N (2). [Lab 2]
Get candle. (Go to Empty Room under Warriors' Quarters.)

The Empty Room

Examine wall. Qvti xbm. Tbz mjhiu.

Ramp 1

D. S. W (2). Get disk. E (2). S (2). Get pack. N. E.
Get card. Put card in slot. Get card. W. N. Get prism.
N. Up. Get cloak. Qvti xbm. Tbz mjhiu. Open
pouch. Pour powder on pack. E (2).

View Chamber

Put disk in slot. Push button. Get disk. W. Drop
prism. D.

Travel Chamber

Get control. Push button.
Enter car. Say
light.
Push

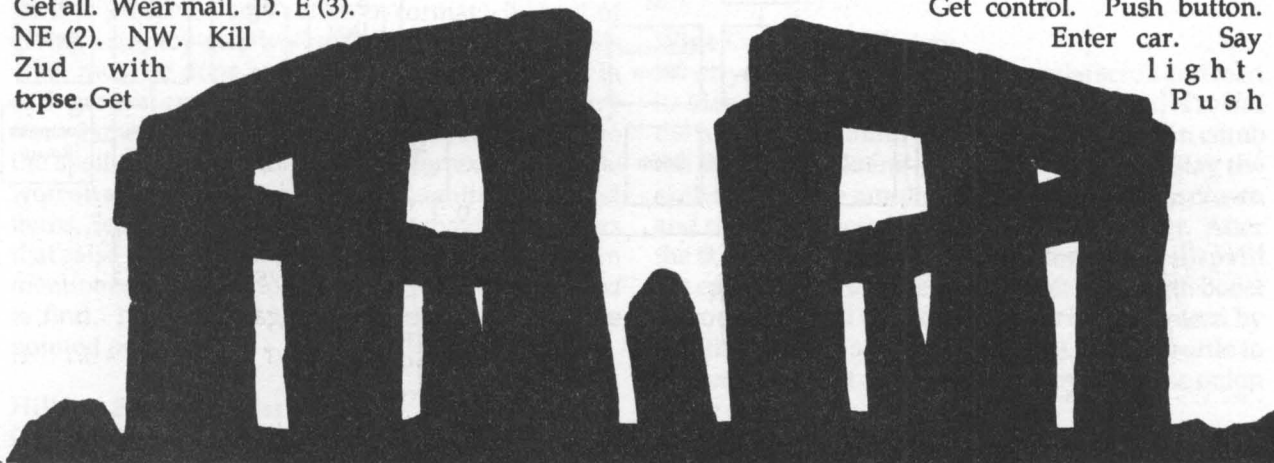

handle. Leave car. Saylight. Drop candle. D. N (2). E. Get printout. Read printout. Drop printout. Put card in slot. W. N. Get wand. S(3). U (2). Xbwf xboe at toblf. Say Nepo. Get key. Get statue. E. N. Open west door. U. Drop wand. Drop control. Get decanter. Look in decanter. Drink water. Get rifle.

D. E. Open east door. Drop key. Put disk in slot. Push button. W. S. W. [Ramp] D (2). N. W (2). Use sjgmf. Get projector. (Go to Hall north of Lab 1.) Get prism. S.

Bozelbon. Get prism. Put prism in portal. [For more points, return for all objects you dropped and put them in portal.] Enter portal.

Castle

Get qsjtn. Csfbl qsjtn

Lab 1

Drop all (including projector). Say

Map Key: Arazok's Tomb

- A: Jewel
- B: Tostins (food)
- C: Book
- D: Sword & mail
- E: Pouch (powder)
- F: Candle, elixir, potion
- G: Disk
- H: Powerpack
- I: Card
- J: Prism
- K: Cloak
- L: Control
- M: Printout
- N: Wand
- O: Key & statue
- P: Decanter & rifle

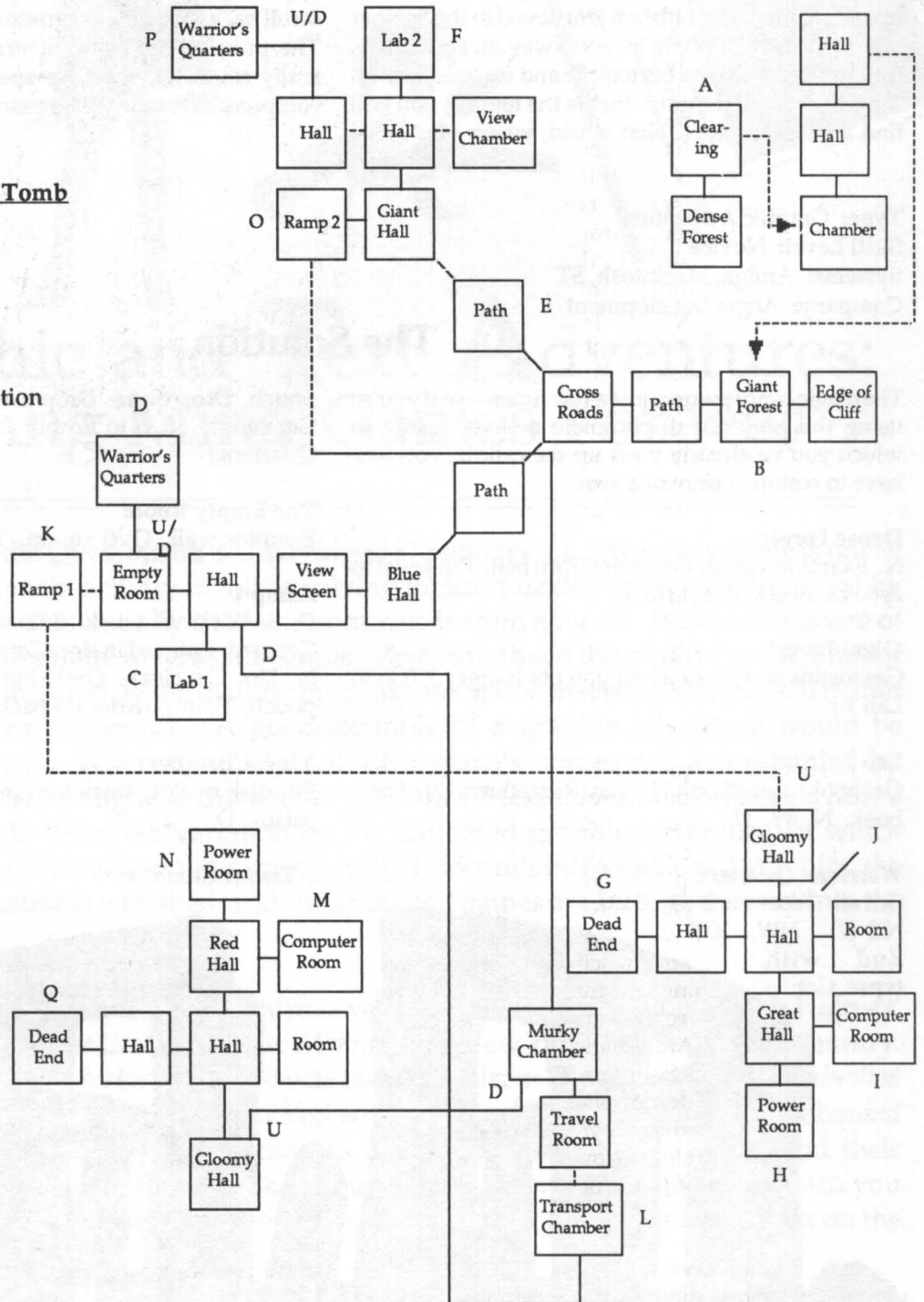

Beyond Zork

Infocom's first foray into role-playing games, *Beyond Zork* is an all-text tale that combines logical puzzle-solving with character development and combat. Science is steadily superceding the role of magic in the remnants of the famous Great Underground Empire, where your goal is to recover the fabled Coconut of Quendor so that its secrets may be preserved for magicians of the future. In the early stages, you'll constantly combat assorted monsters to earn experience points and advance your character through the levels. Attributes such as Intelligence are developed by solving related puzzles. After a certain point, the puzzles take precedence over combat, and the game becomes a traditional Infocom text adventure. Lots of new features such as auto-mapping, mouse control and an advanced parser to simplify gameplay.

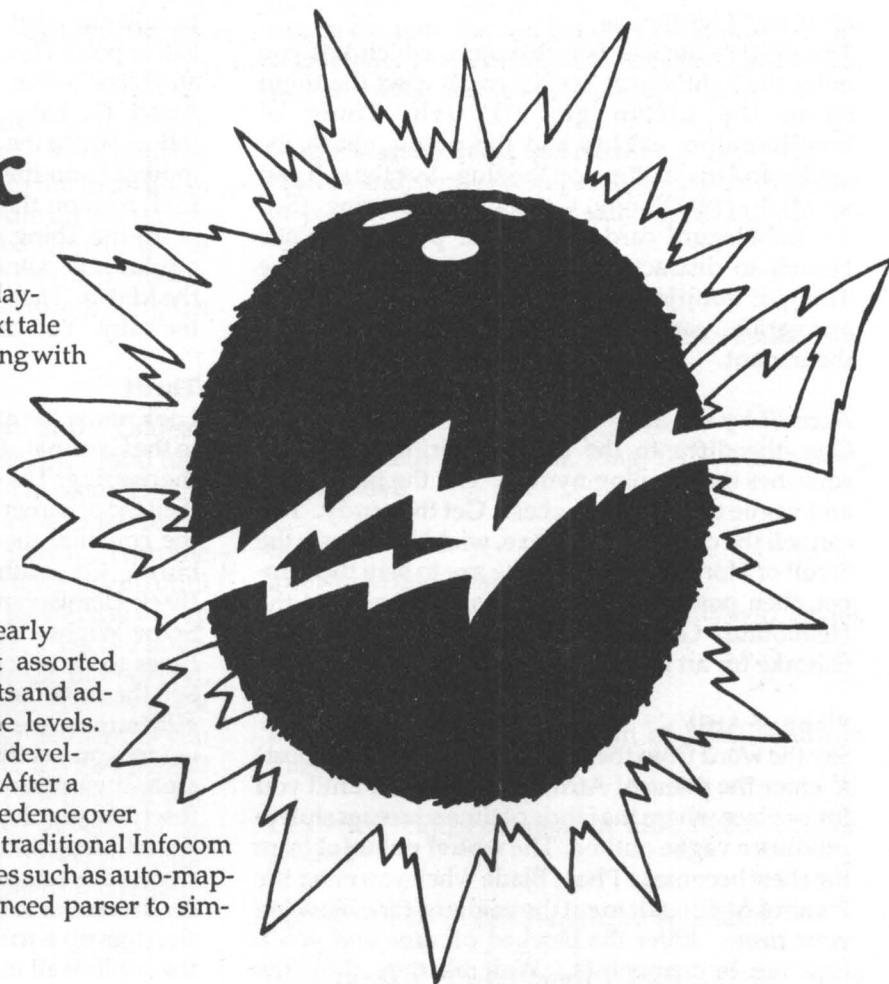

Type: All-text Hybrid

Skill Level: Expert

Systems: Apple II (128K), C 128, IBM (192K), ST, Amiga and Macintosh (both 512K)

Company: Infocom/Activision

The Solution

Many elements of *Beyond Zork* are randomized: locations in many areas, plus the objects found there, are arranged differently, and magic spells often have different names and are cast with different items. For these reasons no map is provided, and the solution itself is presented in a different format. Instead of giving a step-by-step walkthrough, this solution tells what must be done and which spells are needed in each general area. Since the magic items' effect vary from game to game, related answers refer simply to the spell: Thing of Annihilation, for example. The woman at the Magick Shoppe will identify spells and items. Separate lists describe items, magic and things that raise your attributes. If you don't have an item mentioned here, just look around—it won't be hard to find. Locations of those not readily noticed are pointed out.

Hilltop, Sea and Tavern

Go northwest from the start and get the weed at Edge

of Storms. At the dock, examine the sailor's canvas and get the driftwood. Wield it as a weapon. Get the lantern outside the Tavern, enter and wait to hear the bandits mention the helmet. Try to go west, then get the dagger.

Wine Cellar and Kitchen

When you first enter the Cellar, get the scroll and read it. (Say the word on it if your light goes out.) **Trvffaf** the **npft** on the **xbmm** for Dexterity so you can climb the Bottom Stack and get the wine bottle. Slay the skeleton, get the amulet and wear it. Get the crown and search the nest for the coin; sell both later. After the door is slammed on you, **sfbe** the amulet **uispvhi** the **cpuumf** and say the word to get a Strength boost so you can break the door. Conserve the lantern by shutting it off as soon as possible. Give the bottle to the cook. Go east and get the rug, pushing the onion to the cliff wall.

Cliff and Lighthouse

The riddle's answer is **mjhiojoh**, which lets you enter the lighthouse. Inside you'll need the **tbm** (from the **ujebm gmbut**), **uvh**, Thing of **boojijmbujpo**, **ebhhfs** and the **pojpo**. Bash the spider and **uispx tbm** on the slug. **Svc** the **svh** and **upvdi** the Dust Bunny. Get and wear the ring. (Sell the bubblegum card.) **Dvu** the **pojpo** with the **ebhhfs** to distract the Dornbeast, then point the Thing of **boojijmbujpo** at him and take the chest and get all. Search the debris in the top room and sell the sextant.

Accardi by the Sea

Give the **diftu** to the Monkey Grinder after he squashes the warning nymph. Get the palimpsest and vague outline in the chest. Get the gurdy. You can sell the chest. Buy the axe, wield it and use the Scroll of Honing on it. Use the axe to slay the Puppet, then point the Thing of **boojijmbujpo** at the Hellhound. Get all you find in the forest. Eat the fishcake for an Intelligence boost.

Plane of Atrii

Say the word from the **hbujoh** spell (from the chest) to enter the plane of Atrii. Move around until you find a place where the fabric of time squeezes shut to produce a vague outline. The **wbhvf pvumjof** from the chest becomes a Phase Blade when you enter the Plane of Atrii; use it to cut the vague outline blocking your route. Enter the blocked off area and you'll find the Implementors. Wait till they drop the coconut and give you the **hpcmfu**. They'll most likely teleport you to the billboard.

Fields of Frotzen

The **hpcmfu** will protect you from the thunderstorm so you may pass. Get the four-leaf clover when you find it. Wait for a **cvuufsgmz** to land on the **hpcmfu**. Open the gurdy and put the **hpcmfu** in it. Close the gurdy, set the dial to **dmpdl** and turn the crank left. Open it and get the **dbufsqjmmbs** before he runs away. Remove the **hpcmfu** and close the gurdy. Find the scarecrow with a crop of corn around him. Turn the dial on the gurdy to **fzf**, then turn the crank to the right. Note the color of the scarecrow's rags: the Corbies are afraid of this color. Wait until the farmhouse falls, then enter it and stay until the storm subsides.

Land of Froon

Exit the house and examine the flowers. When offered, take the key that's the same color as the scarecrow's rags. When you're transported back to the fields you can pass the Corbies and get the Compass Rose.

Jungle and Idol

Kill or point Thing of **boojijmbujpo** at the crocodile and bloodworm. Find the **Hcnk**, then the Hungus. Attack the baby. The mother will attack you and follow you to the Idol. Climb the Idol and, when the mother is on the bottom, get the jewel. Inside the Idol, turn on the lantern. Squeeze the moss, then point the Thing of **fwfstjpo** at the wall. Find the mother and point the Thing of eversion at her to get the **kfxfm**. Then point the Thing of **mfwjubujpo** at the baby. You can sell the tusk.

Thriff

Look under the **qfx** in the **dibqfm** for the vial. Listen to the Cardinal. Examine the glyph, then go west of the clearing. The **dbufsqjmmbs** will scare the Trees. (Sell the ornament.) Open the mailbox and examine the contents thoroughly. This should net you a burin. Go south and search the bench to get the Black Hemisphere. Go north and west to kill the Snow Wight. You may have to recuperate a few times to do so, or use the Thing of **boojijmbujpo**. Sell the snowflake. Go west and point the Thing of **ejtqfmm** at the dome. Boogie on back to Thriff before you get fried. Make sure you're wearing the **sjoh**, then return to the clearing. With the burin, inscribe a glyph in the hot lava. Ask the Cardinal for the reliquary and get the White Hemisphere from it. Go northwest and hide the minx's footprints. Wait for the hunter to leave, then pet the minx. Wait until she digs up a truffle and let her eat it. Don't forget the sunlit wall to the west of here. Remember, you must pick up the **njoy** to take her to certain places.

Stable

Get the horseshoe. Kiss the unicorn's horn first for luck, then say the word on the amulet and smash the stable door. Or you can use Thing of **mfwjubujpo** to free the unicorn and get the saddle.

Pterodactyl

Make sure you're holding the **xffe** and Thing of **boftuiftjb** and have enough room to hold the arrow and whistle. Point the Thing of **boftuiftjb** at the pterodactyl. Get the arrow, then put the **xffe** on the wound. Get and wear the whistle. Put the saddle on the pterodactyl. Get the minx and board the pterodactyl. To fly, "go up" and point the Compass Rose in the opposite of the direction you want to go. Fly until you're over the castle (near Thriff), then land.

Castle

Hide behind the Morgia bush. Get some of the bush and eat it. Wait for the platypus to come and go, then exit the bush. Open the statue and get the Crystal Jar. Blow the whistle, get the minx and

board the pterodactyl. Fly to the Magick Shoppe.

End Game Preparations

Sell the Jewel and buy the Hourglass. Go to the oak tree in the Twilight part of the Forest. Wait until the minx digs up a truffle. Get it. Go to the Clearing in the Forest. The answer to the riddle on the rock is *zpvui*. Enter the Pool of Radiance. The truffle will be preserved for all time. Whistle for the pterodactyl. Stash the truffle in the pack before getting the minx, then fly to the Ruins.

Ruins

Bash the Ghoul. Throw the *wjbm* at the Undead Warrior. Stand under the arch in the plaza and turn the hourglass. Go south twice (back in time). Get the truffle and wait for the Prince's horse to fall in the trench. Throw the truffle in the trench. Turn the hourglass again and go forward in time (north) until you reach the desolation. Wait for the minx to dig up a truffle. Get and wear the helmet. Turn the hourglass and return to the plaza. Use the pterodactyl, Scroll of *hbujoh* or *sfdbmm* return to the Magick Shoppe. Buy the potion of Enlightenment if you haven't already. Shake and drink it. You should now have enough Intelligence to continue (if not, see tips on how to boost it). Insert the peg on the Black Hemisphere into the hole on the White Hemisphere. Look into the now Gray Sphere and remember the magic word printed there.

Underground and End Game

Make sure you have the following items: rabbit's foot, horseshoe, four-leaf clover, Jar of Mirrors and *mboufso*. Rub the foot for extra luck. Go to the cliff wall near Thriff (where you found the minx). Say the magic word from the Gray Sphere and open the door. Enter the first underground room. A Luck-sucker will eventually show up. Throw one of your lucky items at it each of the three times it appears. In the first underground chamber open the jar, get the circlet and type "blow bubble." Point the resulting mirror in a direction so you can reflect the sunlight around the corners and deeper into the tunnel (for example, pointing the mirror to the north will angle light from the northeast to northwest, or vice versa).

Keep blowing bubbles and exploring the rooms until you find the Treasure Chamber. *Bohmf* the light in the most direct route to that room. The mirrors don't last long, so make it snappy. ("Dip circlet" isn't necessary; "blow bubble" will suffice and save time.) Blow the last mirror in the Treasure Chamber and angle the light to shine on the Shadow in the corner. If your Compassion is high enough, it should overwhelm the Ur-Grue and you'll be able to

search the plunder and get the Coconut. If you try to exit the cave an earthquake stops you. Not to fear, you are saved and...*Beyond Zork!*

Magic Wands, Items and Scrolls

(Each wand, item or scroll's magical effect may vary in your variation, but the same spells are used in solution.)

Magic Wands

Dispell, Levitation, Annihilation, Anesthesia, Say-anora, Eversion

Magic Items

Amulet, Rod, Palimpsest, Ring, Stick, Parchment, Cane, Stave

Scrolls

Fireworks and Mischief: No use
Gating, Honing, Protection, Refreshment, Recall, Rumped, Smooth

How to Raise Attributes

Intelligence: Fishcake, Potion of Enlightenment, Pheehelm

Dexterity: Squeeze moss in Idol, Cellar, Underground

Strength: Potion of Strength, Morgia Root.

Compassion: Cover minx's tracks, rescue baby hungus and unicorn.

Luck: Rub rabbit's foot, kiss unicorn's horn.

Endurance and Level: Defeating certain monsters (and enough of them) and solving some problems (vague outline) increases these.

Armour Class: Buy more armour!





Dark Lord

Upon discovering your grandfather's journal from the 1940s, you learn of the Afterworld—an enchanted place ruled by the malevolent magician, Lord Nequam. Your grandfather had traveled there and defeated him, but the Dark Lord has returned from the dead and can only be finished off by you. In addition to bright and colorful graphics, the gaming experience is enhanced by good sound effects and music. The tunes don't play incessantly, forcing you to turn them off and there are entertaining special effects such as waterfalls and other spot animation. The parser does not accept multiple commands, but does offer a variety of keyboard shortcuts saving typing. Your score is based on the number of commands required to complete the quest, allowing you to compare your adventure skills with those of other players or with your previous efforts. Three skill levels are available: Normal, Easy and Random. Easy level gives more clues, Random scrambles the location of objects and Normal is Intermediate in difficulty. Eight games can be saved on the program disk.

Type: Graphic Adventure
Skill Level: Gamer-adjustable
Systems: C 64/128, Apple II
Company: Datasoft/Electronic Arts

The Solution

This covers the game's "Normal Difficulty" version.

Hidden Room

Enter mirror.

Stone House

Get `tdbsbc`. N. Say hello. Say yes. Get `tujdl`. W. S.

Burning Village

Look ground. Get `sbu`. W. N. N. E.

Pleasant Stream

Look stream. Get `gjti`. W. N. N. N. N. E.

Deserted Storehouse

Get lamp. N. Look dock. Get

`spqf`. W. W.

Boathouse

Say hello. Give `gjti`. Get `tdspmm`. Read `tdspmm`. E. S. S. S. S. E. Get `gjti`. W. S. S. S. W. W. W.

East-West Trench

Look tree. Get `blossom`. E. E. E. N.

Edge of Cliff

Ujf `spqf` to tree. D. W. W. N.

Krin

Give stick. Eat `cmpttpn`. Ask about `cmpttpn`. Look ground. Get flask. Get stick. S. E. E. U. S. W. W. N. N.

End of Path

Fly. Get `byf`. Fly. E. E. Fly (three times). N. N. D.

Inside Ancient Structure

Put `tdbsbc` in indentation. North (quickly, before door closes). N.

Underground Chamber

Give `gjti` to cat. Get `tlvmm`. W.

Ancient Burial Chamber

`Npwf` `efcsjt`. W.

Dark Passage

Look ground. Get `cowngv`. U. Fly (twice). S. S. S. S. S. Fill flask with water. (Go to North-South Trench.)

North-South Trench
 Cvso qmbou with mbnq. W. W.
 N. N.

Lava Opening
 Look plant. Get mfbg. [Rzud.]
 Qpvsxbufs in stream. Kvnq (must
 be done quickly). Svc mfbg on
 cpez. W. W.

Resting Place
 Kill monster with byf. (Go to
 Clearing.)

Clearing and Guard in Castle
 Swim (to Dock). W (four). N
 (three). [Guard] Svcbnvmfu. Get
 key. Unlock door.

Cell
 Npwf upsdi. W. W.

Massive Stone
 Qsz tupof with tujdl. N.

Power Room
 Put sbu in opening. S. E. N. W.

Crystal Room
 Get crystal. E. Open door. E. N.
 N. N. Open door.

The Evil One
 Throw tlvm.

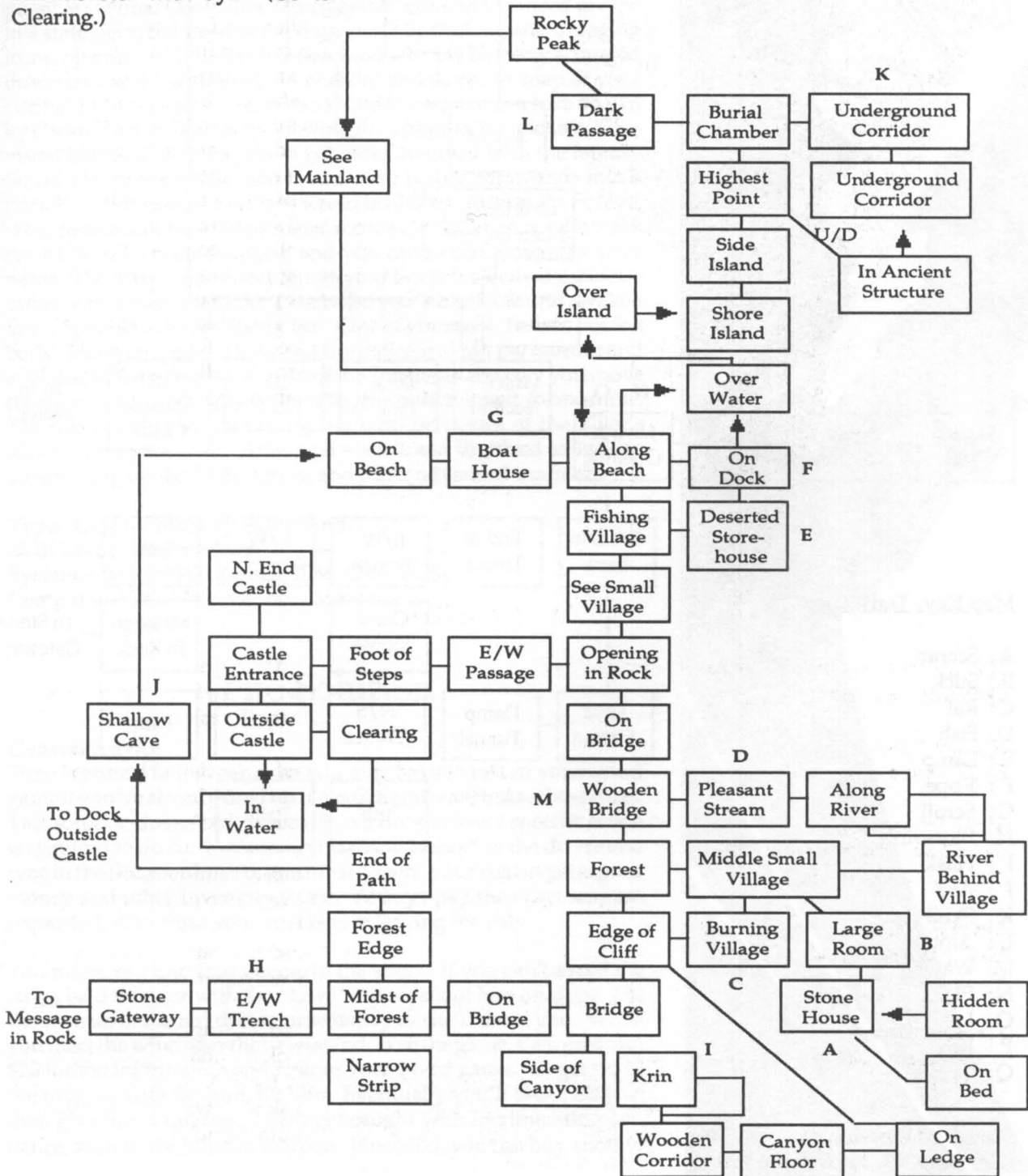

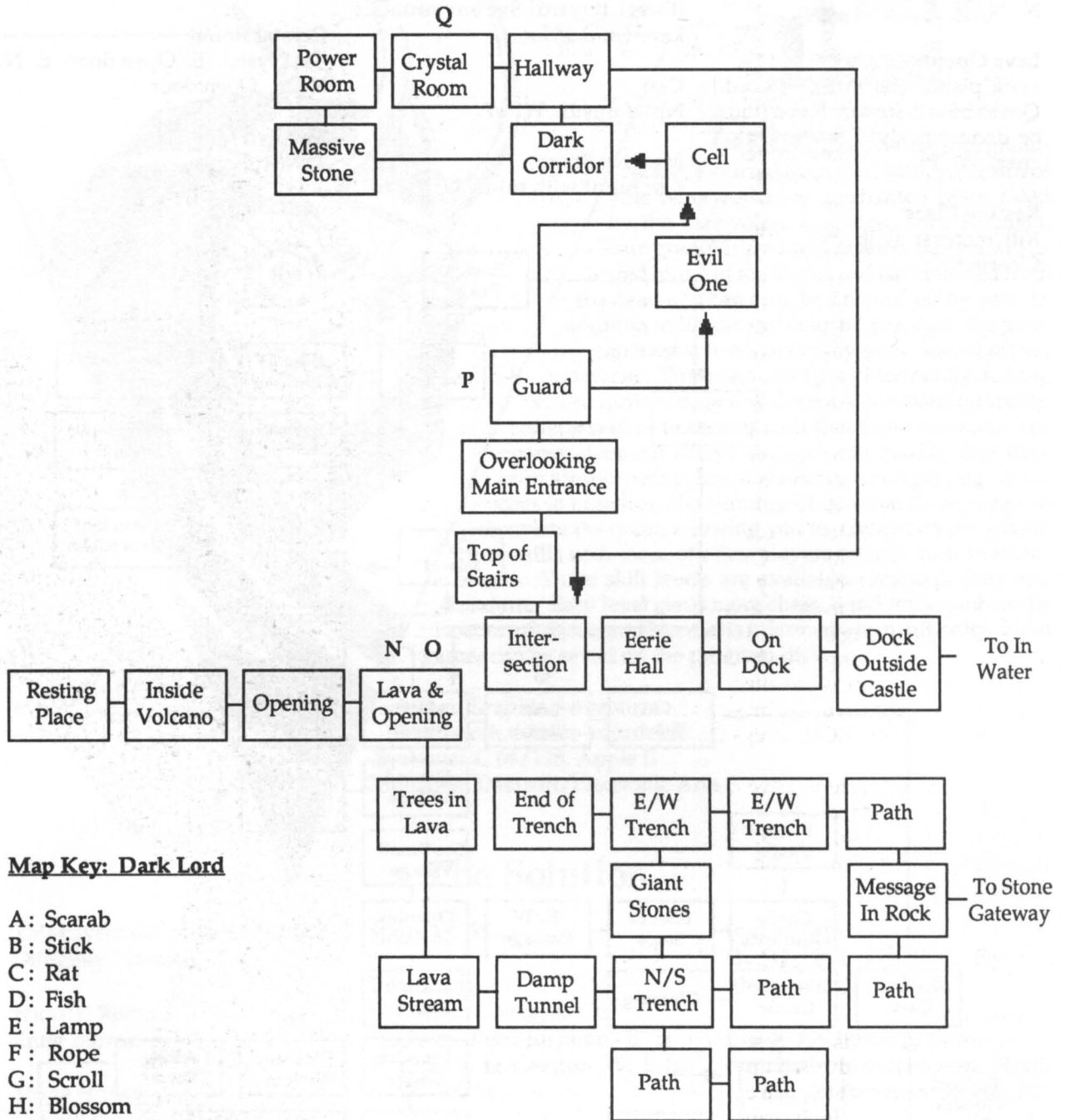

Map Key: Dark Lord

- A: Scarab
- B: Stick
- C: Rat
- D: Fish
- E: Lamp
- F: Rope
- G: Scroll
- H: Blossom
- I: Flask
- J: Axe
- K: Skull
- L: Amulet
- M: Water
- N: Plant
- O: Leaf
- P: Key
- Q: Crystal

Déja Vu

Déja Vu is a 1985 Macintosh mystery recently converted for most other machines, and was ICOM Simulation's first icon-oriented graphic adventure. Instead of typing "pick up key," you click the mouse (or joystick with the C 64) on the key and drag it into a window that represents your coat pocket. To examine or operate things, you first click on the item, then on a verb in a matrix of eight possible actions. Occasionally the "speak" command is used to type in a statement, but most of the time you'll be clicking and dragging icons, opening and closing windows (which may be freely arranged onscreen, except with the C 64 version) and so on. A map of your current location shows the exits as little boxes; you can take an exit by clicking on its box, or by clicking on a door in the picture. This visual interface permits you to get more involved with the fantasy world you're exploring than if you were typing commands into a parser. In this case, the fantasy world is Chicago during the Forties, where you awake in a dingy mens' room at Joe's Bar. A needle mark reveals you've been drugged, and you can't even remember your name. The drug's side effect causes your brain to slowly deteriorate unless you find an antidote. Otherwise you'll black out and awaken as a vegetable in a local loony bin. One of your first discoveries is a body. Hang around too long and the police will pin the murder and a related kidnapping on you. Half the fun lies in the way you move things around, loading a gun by dragging bullets into it, for example. The other half is in unraveling the twin mysteries of the killer's identity and your own. Animated visuals and digitized sound are outstanding on the IIGS, Amiga and other advanced machines.

Type: Graphic Mystery Adventure

Skill Level: Intermediate

Systems: Macintosh, Amiga, IBM, C 64, IIGS

Company: ICOM Simulations/Mindscape

The Solution

General Advice

Time is critical in this game, so you may have to restart your saved game if you've already used up too much and want to use these clues. This solution doesn't tell you to open a door unless a specific action is required to do so. In the cab, you must "speak" to the driver and type in the [location]. Also, you must "open" your coat to get at your money and other inventory items. Always pay the exact amount requested, then close your coat before leaving the cab.

You might run into four people in the street. If you can't avoid the large, bald mugger with the "Love" tattoo, shoot him on sight. Hit the woman in the red dress immediately or she'll shoot you. When you meet the wino near the newsstand, save the game, then give him \$20 for the information and restore your saved game. To get rid of the mugger with the gun, hit him. Eventually you'll break his jaw; then give him a quarter. Don't get caught with incriminating evidence, such as the murder weapon. If needed, you can buy another

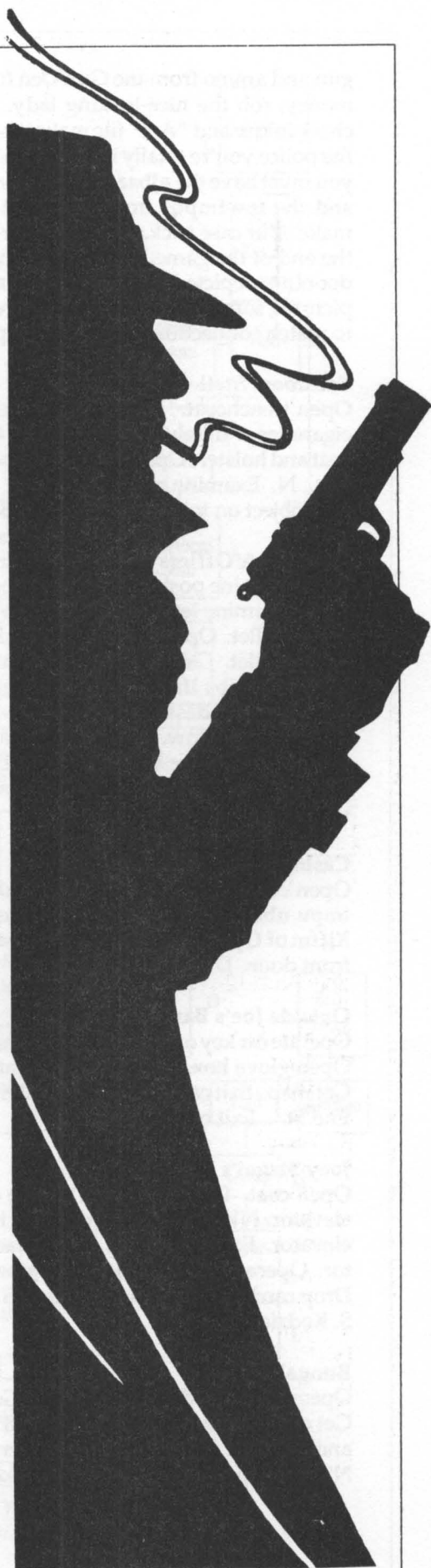

gun and ammo from the Gun Den for \$20. If out of money, rob the nice-looking lady. Also, the bad check folder and "Ace" file make it hard to convince the police you're totally innocent. At the very least, you must have the *ejbsz*, *opufqbe* with *ujnfubcmf*, and the *fowfmpqf* from the *nbo't ojhiutuboe* to make your case stick. (Be sure your printer is on at the end of the game.) Because of the peculiar way doors are depicted on the on-screen maps and in the pictures, some directions given below may not seem to match connections on the accompanying map.

Bathroom Stall

Open trenchcoat. Examine handkerchief, glasses, cigarettes and lighter. Drop them. Close coat. Get coat and holster. Open gun. Examine bullets. Close gun. N. Examine mirror. NE. W. NW. Examine blue object on toilet. Get earring. S. NE. NE.

Joe's Bar & Offices

NW. Examine posters. N. Open desk. Open envelope. Examine letter. Close envelope. Open coat. Open wallet. Operate key on west door. Drop key. Close wallet. Close coat. W. Examine body. *Pqfo cpez*. *Hfu dbs lfz*. Open desk. Get silver key and pencil. Close desk. Open window. N. N. Open northeast window. NE. Open wastebasket. Get syringe. Examine vials. Operate buttons on wall near door. NW. Operate second button from bottom of panel. NW.

Casino

Open coat. Save game. *Pqfsbuf dpjo* on *ofbsftu tmpu nbdijof*. *Hfu rvbsufs*. Close coat. *Pqfsbuf Xiffm* of *Gpsuvof*. NE. E. S. Operate silver key on front door. Drop silver key. NE.

Outside Joe's Bar

Operate car key on car door. Drop car key. Enter car. Open glove box. Examine registration and photo. Get map. Exit car. W. SW (2). Enter cab [1212 West End St.]. Exit cab. N.

Joey Siegel's Place

Open coat. Open wallet. Operate card on slot by elevator. NW. Operate card on slot in elevator. Exit elevator. Examine photo on fireplace. Enter elevator. Operate card on slot in elevator. Exit elevator. Drop card. Close wallet and coat. S. Enter cab [520 S. Kedzie]. Exit cab.

Bungalow

Operate gun on door knob. NW. Get slip of paper. Get earring. Open desk. Get small unmarked key and diary. S. Enter cab [934 W. Sherman]. Exit cab. N. NE. Operate small unmarked key on lock. N.

Dr. Brody's Office

Save game. *Jefoujgz* which *uisff wjbmt dpoubjo tpejvn qfoubuipm* and which *dpoubjo cjptpejvnjujt*. Write this down. Restore game. Operate *tzsjohf* on *cjptpejvnjujt*. Operate *tzsjohf* on *tfmg*. Get the three *tpejvn qfoubuipm* vials. S (2). NW.

Ace's Office

Operate gun on shadow. Operate small unmarked key on door. Drop small unmarked key. N. Examine man. Open file cabinet. Examine the three files. Get file labeled "Ace" (and ammo from the desk if you need it). S (3). Enter cab [Police]. Exit cab. SE (3). N.

Joe's Bar

NW. N. W. Examine slip of paper. Operate *ujsuz-uisff, uxfouz-gpvs, ujsuz-tjy* (typed in as numbers, not words). Drop slip of paper. Open cardboard box. Get unmarked key. Get manila folder. Examine folder. S (3). N. NW. S.

Sewer

E. Operate gun on alligator (when he shows up). S. Put gun, bad check folder and "Ace" file in whirlpool. N (2). Open *nboipmf*. N (2) W (to Trunk of Car).

Mercedes

Operate unmarked key on trunk. Drop unmarked key. "Esbh" *hbh pgg xpnbo*. Operate *tzsjohf* on *wjbm*. Drop *wjbm*. Operate *tzsjohf* on *xpnbo*. S. W. SW (2). Enter cab [626 Auburn Rd]. Exit cab.

Estate

Open mailbox. Examine envelope. Open envelope. Examine letter. N. Operate knocker. Hit butler. N. NE. Open nightstand. Open envelope. Examine envelope. Close envelope. Take envelope. Operate *tzsjohf* on vial. Operate *tzsjohf* on man. Drop vial. NW.

Guest Room

Open nightstand. Examine notepad. Operate *qfodjm* on notepad. Examine notepad. Take notepad. Operate *tzsjohf* on vial. Operate *tzsjohf* on woman. Drop pencil, *tzsjohf* and vial. S (3). Enter cab [Police]. SE (3). E. SE. N.

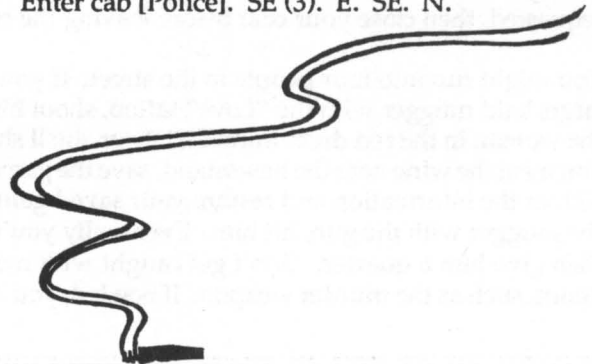

Map Key: Déja Vu

- A: Tenchcoat (handkerchief, glasses, cigarettes, lighter), wallet (key), holster, gun, bullets
- B: Earring
- C: Envelope, safe (unmarked key, manila folder)
- D: body, car key, silver key, pencil
- E: Syringe, vials
- F: Slot machines, quarters, Wheel of Fortune
- G: Car, registration, photo, map
- H: Photo
- I: Slip of paper, earring, small unmarked key & diary
- J: Vials of sodium pentathol & biosodi-umitis
- K: Ace's file, ammo
- L: Mailbox (envelope)
- M: Nightstand (envelope)
- N: Man
- O: Nightstand (notepad), woman

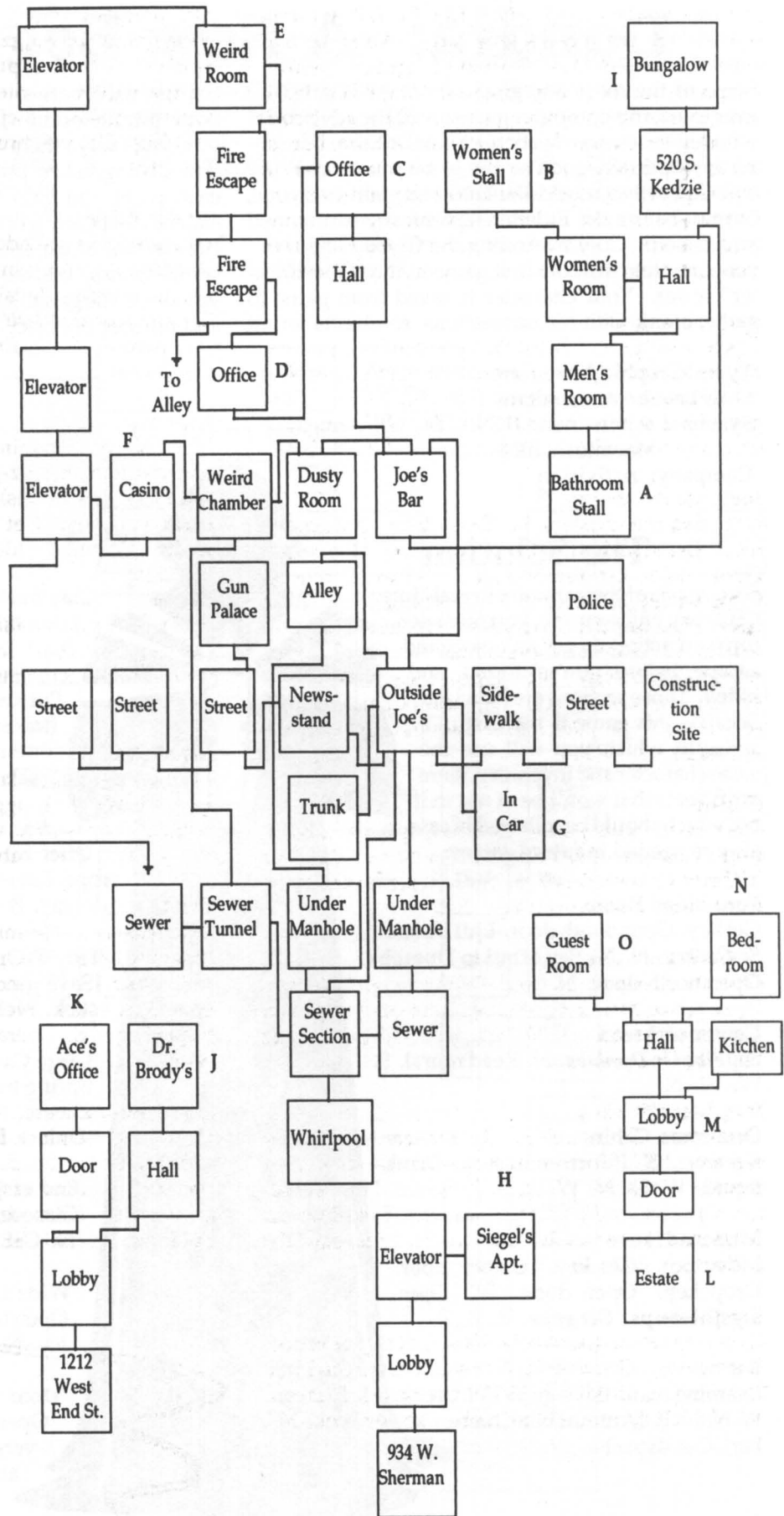

Dondra: A New Beginning

Some of the most engaging cartoon-style graphics ever to adorn a computer game await the adventurer who sets foot in the mystical land of Dondra. (Graphics are especially good on the 16-bit machines.) The evil Colnar has seized the land and slain everyone, but not before the Elders telepathically summoned you to help. Only by finding the Crystal Prism can you complete this, the first game in the "QuestMaster" series. Your character is saved from game to game, along with his possessions, so objects found

but not used here should be collected just in case. Some puzzles occur in real-time, and you get killed if you don't solve them fast enough. The scoring system distinguishes *Dondra* from other adventures: each point you gain for puzzle-solving is also an experience point, with your final score representing the amount of experience you've earned for use in future games. It is modified by the number of times you saved the game, got killed, plus the elapsed time and number of objects you obtained.

Type: Graphic Adventure

Skill Level: Intermediate

Systems: Apple II and IIGS, C 64/128, Amiga, Macintosh, IBM

Company: Activision

The Solution

Some parts of the game are in real-time. Once you enter a room, you must perform an action or get an object and escape before you're found and killed. Those sections are italicized. Because this game is the first in a series in which you will use the same character and inventory, there are objects that won't be of use in it but which should be collected in case they're needed in future games.

Four-sided Room

Get key. Open south door. *Ljdl Ifz* south. S. *Get key.* N. N. Say *efbui* to *Dpmobs*. Open north door. N.

Center of Arena

Say efbui to *Dpmobs*. N. Read mural. S. W. W. N.

One-room Cabin

Get cross. S. Put cross in sack. Drink liquid. W (3). N. W.

Modern House

Move pot. Get key. Unlock door. Drop key. Open door. W. *Open sfgsjhfsbups.* *Get gppe.* E. E. E.

Bar

Examine man. Give *gppe* to man. W. N. N. E. [Automobile Chamber] Get *dspxcbs*. W. S.

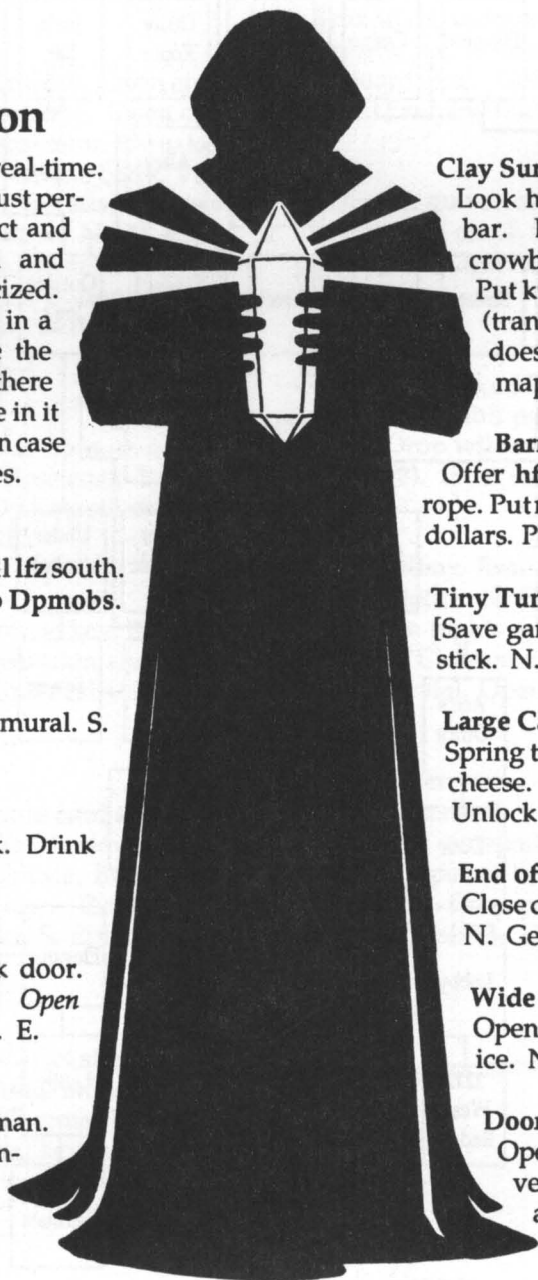

Clay Surface

Look hole. Lift *nboipmf* with crowbar. Look down. Yes. D. Drop crowbar. NW. Cut *wjof* with knife. Put knife in sack. Get fruit. Eat fruit (transports you to Barn. If this doesn't work, however, follow the map to the Barn).

Barn

Offer *hfn* to lioness. Move *ibz*. Get rope. Put rope in sack. N. [Cornfield] Get dollars. Put dollars in sack. E. Get hat. E.

Tiny Tunnel

[Save game.] Wear hat. E. NW. Get stick. N.

Large Cavern

Spring trap with *uxjh*. Get cheese. Eat cheese. N. Enter mover. Get all. D. E. Unlock door. Open door. N.

End of Long Corridor

Close door. Lock door. N. Open door. N. Get ladder. S. W. N.

Wide Crevice

Open ladder. Put ladder across crevice. N.

Door

Open door. (Due to a bug in some versions, the program may not acknowledge that a door exists until you've examined it a few

times and dropped and taken your inventory.) [Save game.] N.

Equipment Room

Open drawer. Get rod. Insert rod into ipmf. Get torch. Dmptf tpvui epps. Charge torch. Get qjo. (It takes about 90 seconds of real-time for the torch to charge. Check its status by saying "Read meter." You have three minutes in this room before you're killed.) When torch is charged, open tpvui door. S. Insert qjo into upsdi. Drop stick. E. N.

Sludge-spraying Room

Pull trigger. Search men. Get keys. Put keys in sack. Get wrench. Put wrench in sack. N. W. W. Drop torch and rod.

Shaft

Press blue pad. W. S. Go south hole. W. S. W. W. N. N.

Bridge

Tju qfeftubm. Say your character's name (look at score if you don't remember your own name!). Say efbui to Dpmobs. Say ufmfqpsubujpo. N. Get saddle. S. S. Get birdseed. S. E.

Peddler

Buy clips. E. Attach clips to fence. S. Drop sack. Drop saddle. N. W. N.

Stream

Get sffe. Enter stream. Get chest. U. Open chest. Lookchest. Get prism. S. E. S. Get sack. S.

Bird

Give cjsetffe. Drop sack. N. Get tbeemf. S. Put tbeemf on bird. Sit bird.

Map Key: Dondra

- A: Key
- B: Cross
- C: Liquid
- D: Key
- E: Food
- F: Crowbar
- G: Fruit
- H: Rope
- I: Dollars
- J: Hat
- K: Stick
- L: Cheese
- M: Ladder
- N: Torch and pin
- O: Key, wrench
- P: Saddle
- Q: Birdseed
- R: Clips
- S: Chest and prism

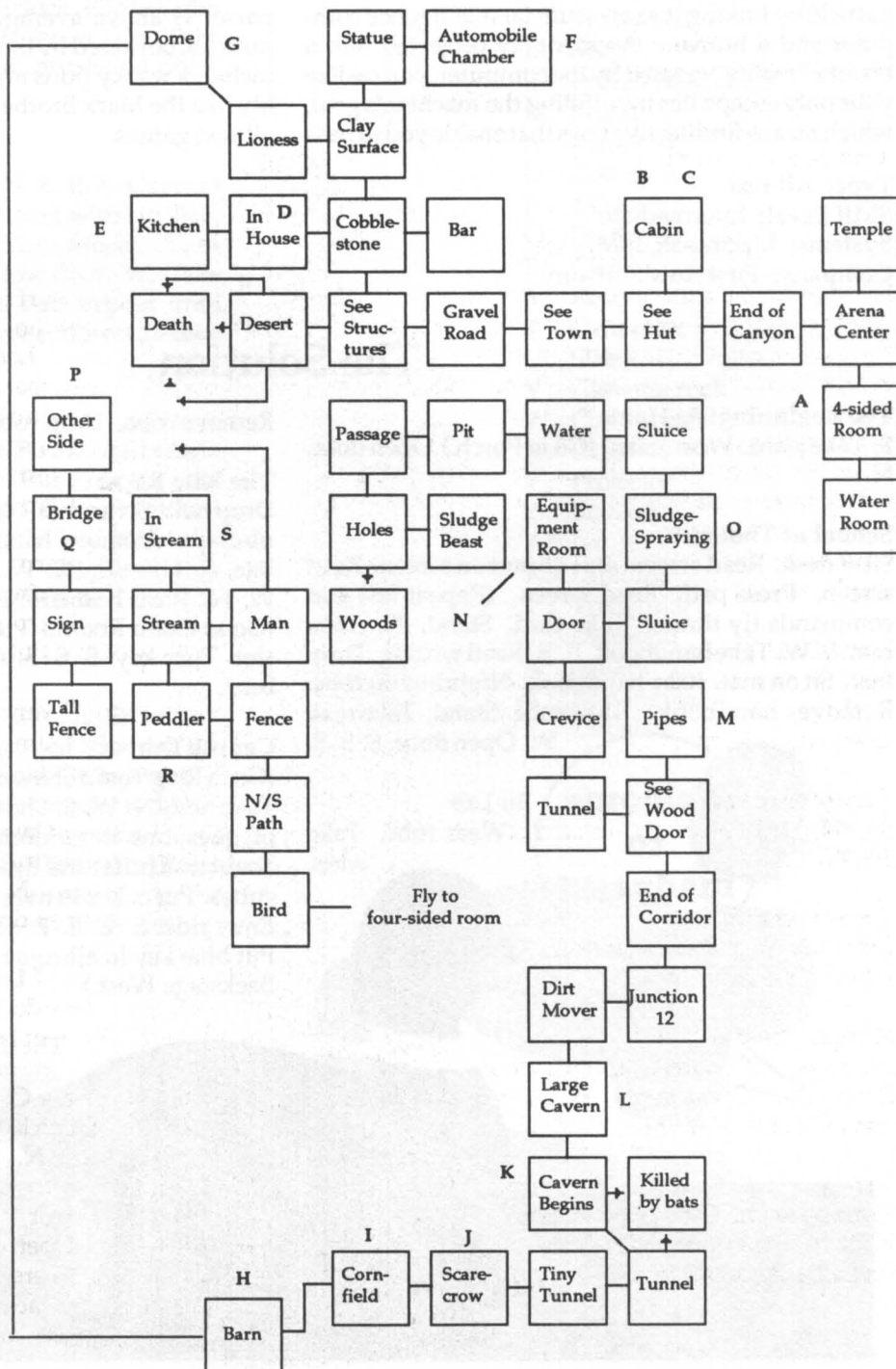

Dr. Dumont's Wild P. A. R. T. I.

A typically madcap mindblower from Michael and Muffy Berlyn, this tale finds you caught inside Dr. Dumont's L. E. T. S. P. A. R. T. I. machine: Laboratory Experiment Study using Particle Accelerator and Reality Translation Integrator. The machine is meant to study the life span of a subatomic particle by linking it to an artificial intelligence computer and a human. Accidentally projected into a bizarre "reality" created by the computer, you realize your only escape lies in fulfilling the machine's goal, which means finding five keys that enable you to pass

an I. Q. test and graduate from the School of Thought. Hints can sometimes be obtained by "meditating" on a particular object or problem. Other clues are presented in the form of Zen koans such as "What is the sound of one duck quacking?". Pull-down menus and keyboard shortcuts simplify gameplay, and the parser is above average. With logical and clever puzzles, bolstered by the Berlyn style humor—which includes wacky puns and three characters remarkably like the Marx Brothers—this is one of 1988's best all-text games.

Type: All-text

Skill Level: Intermediate

Systems: Macintosh, IBM

Company: First Row Software

The Solution

The Beginning: At Home

S. Take jeans. Wear jeans. (Go to Porch.) Open door. N.

School of Thought

Sit at desk. Read screen. Put qbmnt on screen. Read screen. Press pad. Read screen. (Repeat last two commands tjy times.) Take card. Stand. N. Take mat. S. W. Take handbook. E. E. Read writing. Drop mat. Sit on mat. Xfbs handbook. Nfejubuf on robe. Remove handbook. Take robe. Stand. Take mat. W. Open door. S. S. S.

Remove robe. Drop robe. NE. NE. E. E.

The Kite Races

Drop mat. Sit on mat. Xfbs handbook. Nfejubuf on ubdizpo. Remove handbook. Stand. Doc, release kite. E. NE. SE. SE. W. NW. W. W. Take hmbttft. W. N. Wear hmbttft. Take bear. Remove hmbttft. (Go to Exam Room.) Put zfmmpx key in triangular slot. Turn key. S. S. S. Drop glasses, handbook and bear.

County Fair

(Go to Ring Toss.) Show dbse. Take ring. Throw ring. Take nvh. N. W. S. Show card. Take quiz [the order of questions is randomized; answer yes to those about nvtlfuffst and dpx ubp, no to all others]. Take cubes. Put cubes in nvh. N. W. S. Enter ride. N. N. Enter ride. S. E. E. E. SE. SE. Drop mug. N. N. N. Put blue key in ejbnpoe slot. Turn blue key. (Go to Backstage West.)

**Welcome
to
madness!**

In Lab

Wear robe. Take wires.

The Theater: Backstage West

Take brush and pillow. (Go to Lab.) Drop brush.

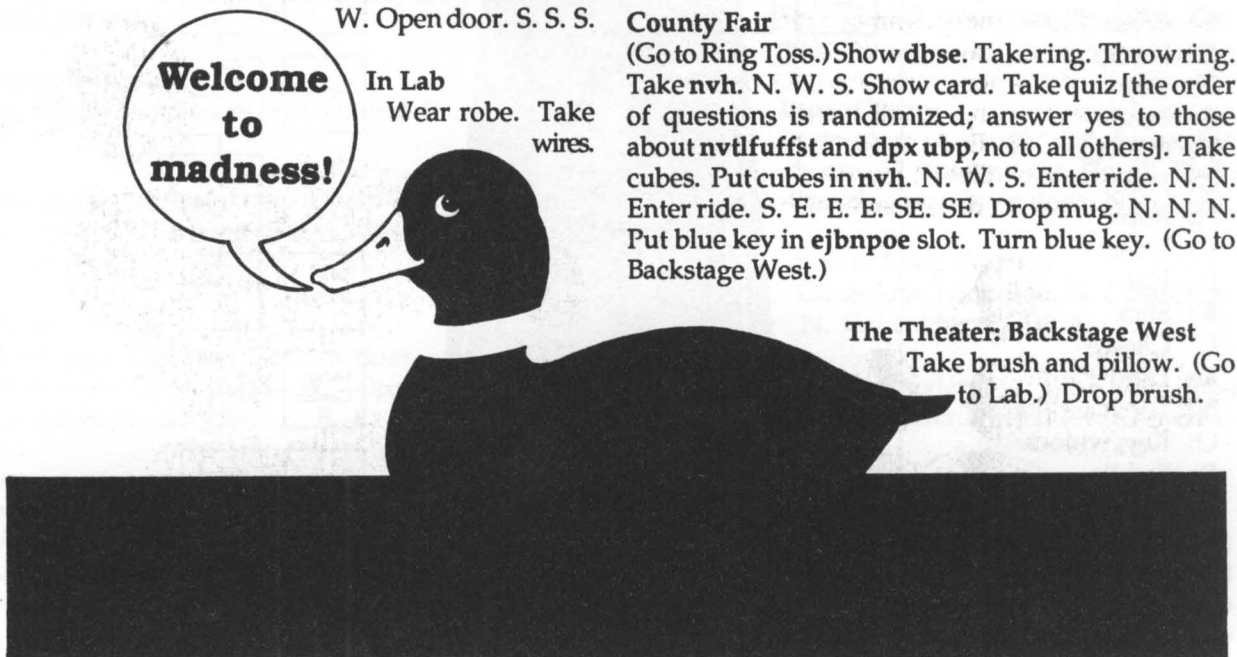

Near the Pond

(Go to Miniature Golf.) Take **dmvc**. N. N. N. Hit pinata. Show card. Hit pinata with **dmvc**. W. Open **qjmpx**. Take **gfbuifst**. Put **gfbuifst** in **qjmpx**. Close **qjmpx**. E. E. Take book. Point to key. Take key. SE. E. E. Drop **qjmpx** and **dmvc**. N. N. N. Put green key in square slot. Turn green key. S. S. S. Take brush.

The Theater: Backstage East

(Go to West Catwalk). **Sfbc cpl** to cat. E. D. S. Take key with **csvti**. Take clock. (Go to Exam Room.) Put red key in rectangular slot. Turn red key. S. S. S. Drop book, brush and clock. Take **xjsft**. SE. SE.

Science Art Museum

S. E. N. Turn faucet. S. W. N. E. E. E. Connect **xjsft** to generator. N. Connect wires to slab. SW. S. Open door. S. Turn faucet. Turn handle. Turn wheel. N. Close door. W. Take rock. NE. NE. Examine slab (repeat until codeword appears). W. Type codeword. Take laser. (Go to Planetarium.)

Planetarium

Put laser in projector. W. U. Push black button. D. E. Take **cmbolfu**. E. E. Put **cmbolfu** over jar. Break jar. Take blanket. Take violet key. (Go to Exam Room.) Put violet key in circular slot. Turn violet key. S. S. S. Drop card, rock and jeans. Take bear, mug, pillow and clock. S. S.

Showtime at the Theater

Show **eqmpnb** to man. S. SW. E. Sit in seat. [Note: this triggers the endgame.] (Some of the remaining moves may have to be repeated if they don't work, since your character is disoriented at this point and not all commands will register.) N. N. E. E. E. E. (Bedroom) Enter bed. Drink milk. Sleep (you must have the **cfbs**, **nvh**, **qjmpx**, **dmpdl** and **cmbolfu**).

Map Key: Dr. Dumont

- A: Jeans
- B: Card
- C: Mat
- D: Handbook
- E: Float robe
- F: Wires
- G: Clue from handbook
- H: Kite
- I: Psychedelic glasses
- J: Teddy bear
- K: Mug
- L: Frozen milk cubes
- M: Brush
- N: Pillow
- O: Golf club
- P: Piñata
- Q: Feathers
- R: Clock
- S: Faucet
- T: Generator
- U: Slab
- V: Glowing rock
- W: Codeword
- X: Laser
- Y: Projector
- Z: Blanket
- A1: Jar
- A2: Diploma
- 1: Triangular
- 2: Diamond
- 3: Square
- 4: Rectangular
- 5: Circular

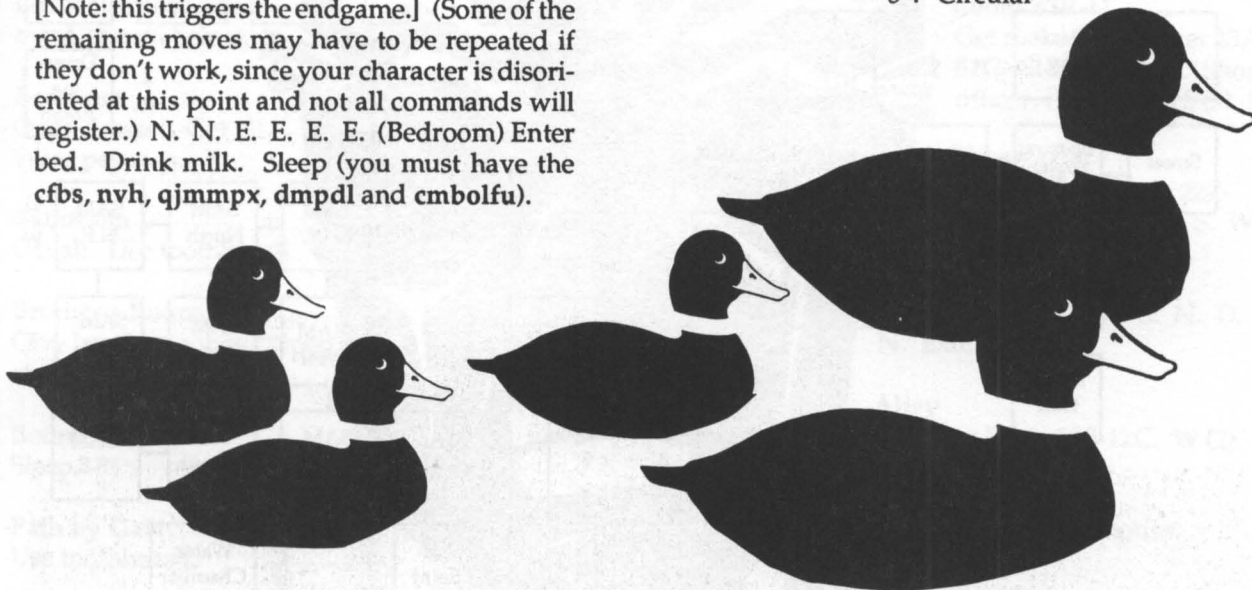

Dr. Dumont

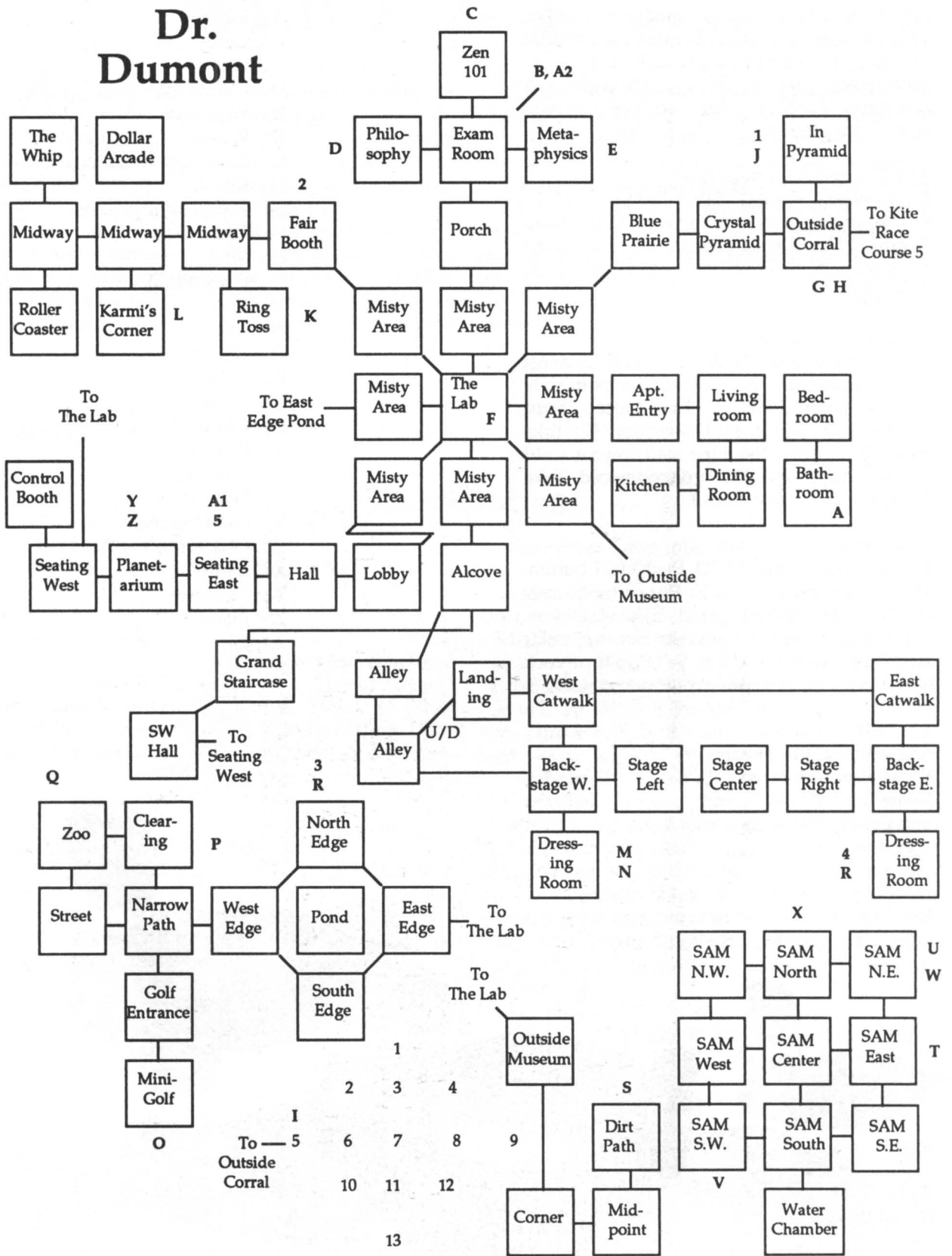

Dream Zone

Nightmares —you've had them before, but this one happens every night! You hope a psychiatrist can help. Dr. Fraud says a beast rules your mind when you fall asleep, and unless you kill it tonight you'll never awaken again! The digitized photos illustrating the first scenes of this strange story are shown in black and white. After solving a few puzzles, you'll fall asleep and be dazzled by a

dreamscape of beautiful color paintings enhanced by spot animation. Puzzles are especially approachable because there are no red herrings to drive you insane: every object you find must be used somewhere in the game. Three characters also turn up to help you at specific points. Pull-down menus, mouse support for moving, and other thoughtful design features (plus some of the most spectacular graphics you'll ever see) compensate for the limited two-word parser.

Type: Animated Adventure

Skill Level: Intermediate

System: IIGS

Company: Baudville

The Solution

In two scenes (the Thief and the Daemon), the parser occasionally won't recognize a command the first few times. This may have been corrected in later versions. Also, in the first release you cannot kill the thief the first time, so be sure to save the game.) The four lifts (elevators) go to floors 1-4. On each floor are ten rooms, from L-A and R-A to L-E and R-E. These are not shown on the map, but necessary directions are provided in the solution. Lift N also has a basement, shown below.

Bedroom

Open dresser. Get all. Wear pajamas.

Bathroom

Get all. Use toothbrush.

Brother's Room

Give brother money. Open chest. Get gun.

Bedroom

Sleep.

Path by Gate

Use toothbrush.

Room S4R-E

Give officer *tboexjdi*. E. N(5). D. D. S. E.

Room S2L-A

Shoot officer. Get 16D-970. W. N. D. N. E. U(2). E(4). S.

Room E3R-D

Give officer 17D-16B. N. W(4). D. E(2). N.

Room E2L-B

Give officer 16D-970. S. W(2). U(2). E(3). N.

Room E4L-C

Give officer 11X-16B. Give officer 51M-970. S. W(3). D(3). W. S. U(2). S(4). W.

Room S3R-D

Get rock. Give officer 43A-81G. Steal 69B-12C. Shoot officer. E. N(4). U. S(2). E.

Room S4L-B

Talk to officer about 22Z-131. W. N(2). D(2). S. W.

Room S2R-A

Give officer 22Z-131. E. N. D. N. Exit. S. E.

Alley

Give Fox Form 69B-12C. W(2).

Crowd

Say Drinks are on the house.

Bar Door
Ebno.

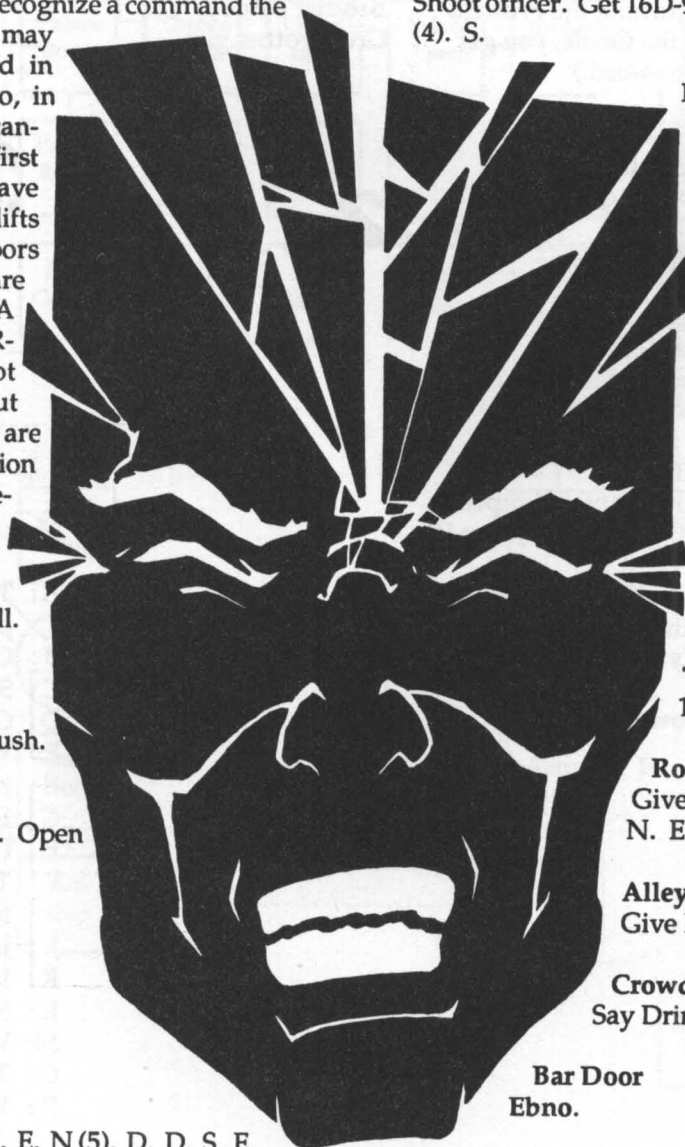

Romper Room
Get soap. Use tpbq.

Crowd.
Fohbhf hjsm.

Secular Church
Get wafer.

Pulpit
Nbssz hjsm. Ljtt xjgf.
S. S. S. U.

On the House
Buy keys.

Alley
Cvz mpbo.

Bar Door
Show Bonzo ID. S.
Drop ID.

Bar
Talk to twins about
gum. Give bartender
wafer. Use keys. W.
Exit.

Terminal
Buy tickets.

Games
Tufbm teddy. Tufbm
tokens.

Carnival
Give kids tokens.

Big Top
Buy ticket.

Freaks
Give Hairy candy. Give
Grajunk gum.

Bar
Get jacket.

Sword Smith
Give Smith jacket. S (2).
Swim. Enter.

Cave
Give Jacque keg. Exit.

Rock Garden (L)
Give Sushi sjdf.

Rock Garden (M)
Shoot thief.

Rock Garden (N)
Ejh hbsefo. Get all.

Throne Room
Give Emperor rock.

Servant
Give servant vase.

Imperial Bed
Get rock. Give Princess
teddy. E. E. S. S. (For
returning the Princess
to the Castle, you get
the sword.)

Dock
Fish. (Must have
xpsnt.)

Alley
Give shark tuna.

Bar John
Talk to John about ubtl.
Exit.

Airship
Give Captain hmpcf.
Say ready. N. Jump W.

Drunk
Hit drunk. Get wine.
Kvnq.

Tower

Give Rambone upojd.
U.

Key Tower
Swap spdl with key. D.
D. S. Say ready.

Deamon Door
You won't see a picture
of the door, just of the
Deamon; you must first
walk in that direction in
order to have the
encounter. Use sword.
Throw xjof. Use the
key. Use qmvoahfs. Use
the key.

Bedroom
E. N.

Brother's Room
Give brother gun.

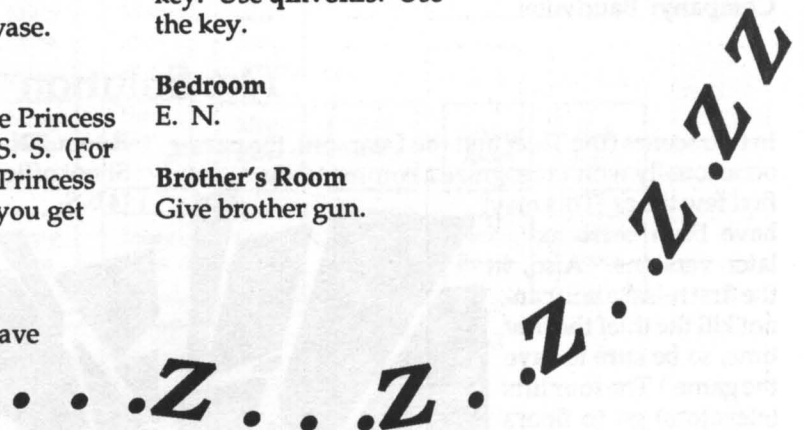

Map Key: Dream Zone

- A: Toothbrush and plunger
- B: Gun and brother
- C: Soap
- D: Girl and receipt
- E: Wager
- F: Keys
- G: Loan
- H: Tickets
- I: Teddy bear and tokens
- J: Jacket and gum
- K: Jacque
- L: Sushi
- M: Worms
- O: Tuna
- P: Wine

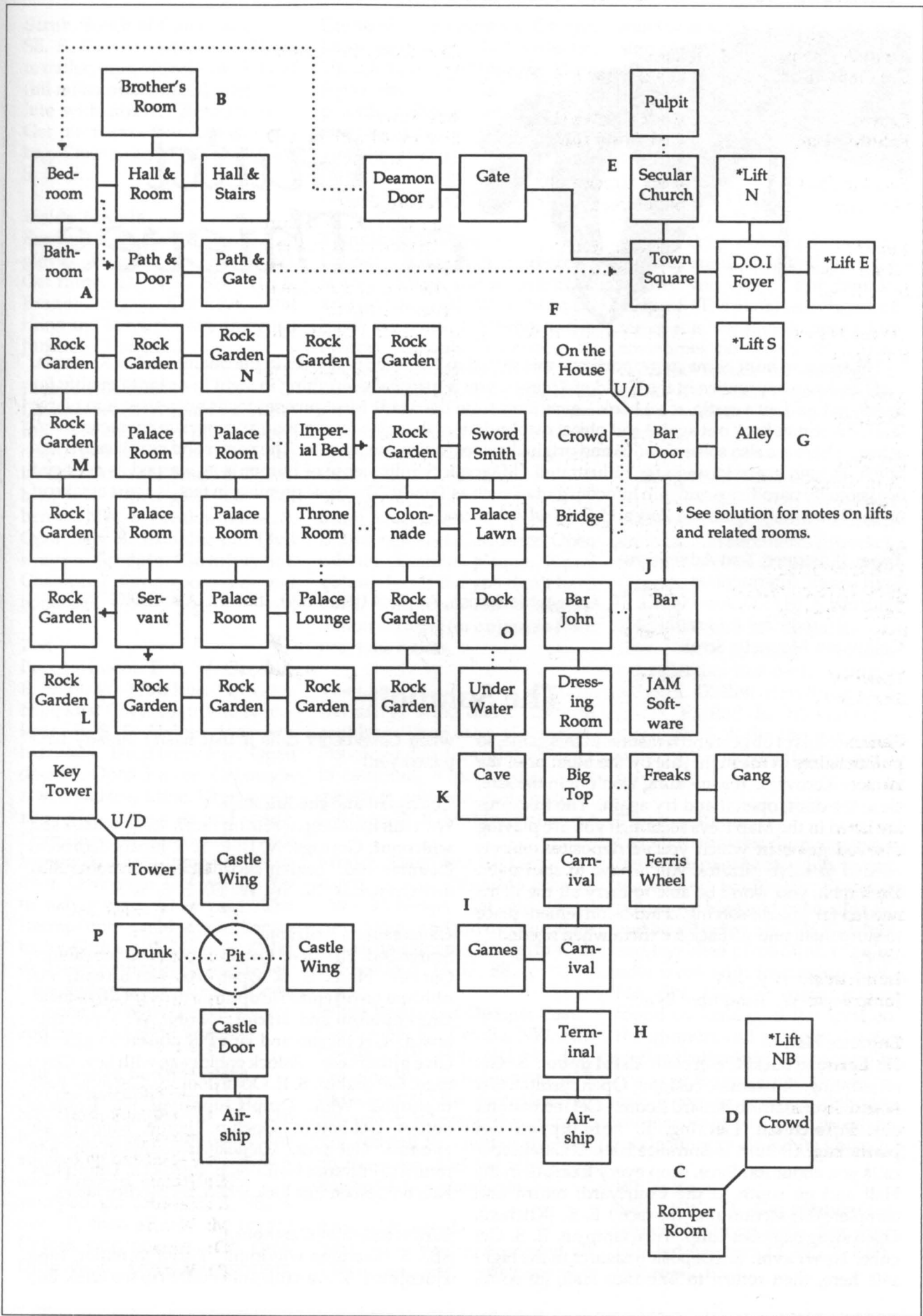

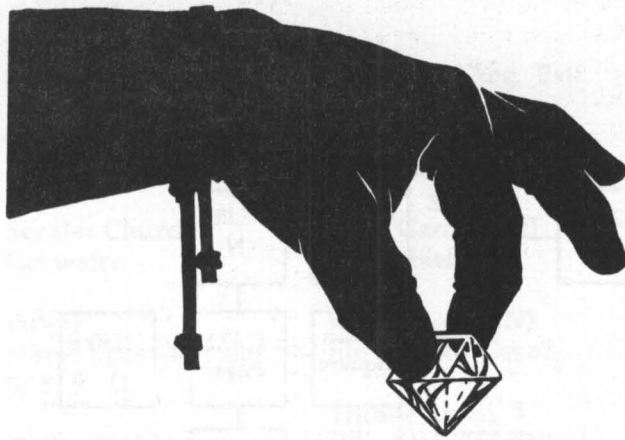

Guild of Thieves

A treasure hunt of major proportions, this sequel to *The Pawn* is also set in the quaint land of Kerovnia. As an apprentice in the Guild of Thieves, you must steal everything in sight in order to qualify for membership: loot a castle, rob a bank—even steal from the dead! Most puzzles focus on getting into places (and sometimes back out again) and object manipulation, though a few require appropriate character interaction. There are also some devious and original mazes to circumnavigate. The parser and graphics are top-notch, though every location isn't illustrated. Magnetic Scrolls' sense of humor is as warped as ever and occasionally parodies puzzles in Infocom games such as *Trinity*. The basic premise, in fact, is a sort of takeoff on the Thief that appears in *Zork* and *Original Adventure*.

Type: Illustrated Text Adventure

Skill Level: Intermediate

Systems: C 64/128, Atari (48K), ST, Amiga, Macintosh, Apple II (text-only), IBM (EGA and 640K required for graphics)

Company: Magnetic Scrolls

The Solution

There are lots of objects and treasures in this game, so put treasures in the night safe by the Moat or at the Bank of Kerovnia. If something won't fit in the safe, close the door, open it and try again. The treasures are listed in the Map Keys section. If you are playing a saved game in which you've deposited objects needed to solve puzzles, you'll have to start over. Even then, you won't be able to carry all the items needed for puzzle-solving. Find a convenient place to store them and go back for them when needed.

In the Boat

Jump west. W. Ifmq nbo. N.

Entrance Hall

W. Examine bucket. Get coal. Csfbl dpbm. S. Get oil painting. S. Examine cushion. Open cushion. Get note. (Go upstairs to Billiard Room.) Get red ball and cue. Pqfo cbmm. Get ring. E. Pqfo tuppm. Get plastic bag. (Return to Entrance Hall. If Gatekeeper calls you about Rat Race, drop every treasure in the Hall and go south to the Courtyard; return and complete this section after the race.) E. S. [Kitchen]. Open swag bag. Get lamp. Turn lamp on. E. S. Get cube. Npwf kvol. S. (Deposit treasures in the night safe here, then return to Entrance Hall; go south

when Gatekeeper calls if that hasn't already happened yet.)

Courtyard and the Rat Race

Wait (till Gatekeeper sets up race). Cfu po hsbz sbu with opuf. Get cage. N. U. E. E. S. [Spare Bedroom] Examine bed. Search bed. Open wardrobe. Get dress, pot, box. N. W. W. D. E. S. S. S.

Gatekeeper's Bedroom

Search bed. Pqfo uvc. Get nbhhpu. N. Open cabinet. Get key. N. E. S. S. Open box. Get offemf. Put nbhhpu on offemf. Tie dpuupo to dvf. Gjti in moat. Drop dpuupo and offemf. N. N. W. Open cupboard. Get poison and jar. Put poison on gjti. N. Give gjti to bear. Unlock cubic cage with key. Open cage. Get chalice. S. E. Open door. N. Get pipe. Pqfo tupqdpdl. Wait. Dmptf tupqdpdl. D. Examine bottles. Get bottles. Open red bottle. Mpl jo sfc puumf. Get svcz. (Deposit treasures in safe and return to Entrance Hall.) N. E. Pqfo kbs. Dmptf kbs. Rub horseshoe (for luck when rolling dice later).

Scrub, South of Gatehouse

SE. S. Examine windmill. Tipvu to miller, tupq xjoenjmm. S. Wait (till miller offers to sell lute). Buy

Scrub, South of Gatehouse

SE. S. Examine windmill. **Tipvu** to miller, **tupq xjoenjmm**. S. Wait (till miller offers to sell lute). Buy lute with **difrvf**. Examine lute. Get plectrum. Put lute in swag bag. Close swag bag. N. NW. SW. S. S. S.

Inside Temple

Examine altar. Get burner. S. Get gloves. Wear gloves. N. SE. U. Get rhino. D. NW. SW. U. E. Examine organ. Get keys. (Put rhino and burner in safe and go to Junction Chamber.)

Junction Chamber

Qvmm cbst. SW. Examine skeleton. Get chest and bone. Open chest. Get heart. D. W. Untie ladder. (Return to Junction Chamber.) SE. Open gate. SE. Get berries. NW. S. Break window. S. Open flap. S. Examine till. **Qvti cvuupo**. Get **dpjo**. (Go to Junction Chamber.) Drop ebony key and bone. NE.

Zoo

Put coin in slot. E. S. W. Get skin. E. N. N. W. **Tiblf** tree. **Pqfo kbs**. **Espq kbs**. Get coconut and succulents. E. S. S. Unlock door with ivory key. Drop ivory key. Open door. E. Open drawer. Get magazine. Read magazine. Drop magazine. Get **hspuuz lfz** and spade. Open door. NE. Unlock door with **hspuuz lfz**. Open door. NW. Close door. Open cage. Get mynah. Put mynah in cage. Close cage. **Tbz ifmmp** (until **nzobi** says it, then go to Zoo Office.) W. N. N. E. **Csfbldpdpovu** with **tqbef**. Drop **tqbef**. Give **dpdpovu** to macaw. (Go to Junction Chamber, get ebony key and bone and go to Temple.)

The Colored Squares Maze and the Sarcophagus

NW (from Temple). D. SE. (To bypass squares, list **dpmpst** of the **sbjocpx cbdlxbset**—VIBGYOR—and proceed accordingly. If stumped, go: SE, N, E, E, SE, S, SW, E, then SE into the crypt.) Unlock sarcophagus with **cpof**. Drop **cpof**. Open sarcophagus.

Get skull. Examine skull. Get eye. Drop skull. E. Get statuette. Unlock door with **fcpoz lfz**. Drop **fcpoz lfz**. Open door. E. Get pamphlet. Read pamphlet. (Deposit statuette in safe, then go to Temple: to exit the Squares maze from the White Square, go NW, N, NW, E, SW, SW, NW, N, NW.)

Temple and Statue

Drop cage, cube, skin, eye, berries, heart. Move statue (must be **xfbsjoh hmpwft**). Wait. **Espq tubvf**. N. N. N. Get brooch. **Ejh** in **tboe**. Get boots. Wear boots. D. D. S. E. Get pick. W. W. Hit mineral with pick. Get chips. Drop pick. E. S. U. E. N. NE (into Junction Chamber. Get cube, skin, eye, berries, heart, then go to Entrance Hall.) U. S. S.

Main Bedroom

Examine cabinet. Get mirror. Open cabinet. Examine plaque. **Npwf qbjoujoh** (get it if you don't have **dvf**). **Dmjnc** on **cfe**. Push top button with **dvf** (or **qbjoujoh** from previous room).

The Lab

Get diary. Read diary. Look in cauldron. Drop cage. Get sachet. Put **cfssjft, tljo, ifbsu, fzf** and **dvf** in cauldron. Open sachet. Put **qpxefs** in cauldron. Get anticube. Get cage. W. (Go to Muddy Room.)

Muddy Room and the Gem

Examine wax. **Sfgmfdu cfbn** at **xby** with **njssps**. Get gem. (Take gem to Bank and put it in safe, then go to Coals Room.) **Svc gffu** with **tvddvmfout**. U. U. SE.

White Room and Opaque Case

Get die. SE. SE. Get die. NW. NE. Get die. SW. SW. Get die. NE. Examine case. Examine slots. Roll all dice (until a five comes up. Put this one in its respective colored slot and roll for another five and do the same until the others are finished.) Get plastic die.

Bank of Kerovnia

(Make sure you've deposited all fifteen treasures; sometimes you

must wait for the man to change a sign and open the bank.) Drop all except bottle, **dbhf** and gum. **Difx hvn**. Open door. Enter bank. Examine bottle. **Nzobi, ippsbz** (until bird says it). Enter **mpoh rvfvf**. Show **dbse** to teller.

In Manager's Office:

Opening the Vault

[Save] Drop **dbhf** and **cpuumf**. **Tiblf cpuumf**. Wait (till manager escorts you out). Put **hvn** in **lfzipmf**. (The **nzobi** will **efupobuf** the **cpuumf** by saying **ippsbz**, but sometimes he won't **tbz ju** in time—the reason for saving the game. If it doesn't **fyqmpef** while you're outside, restore and try again.)

Getting Back in the Office

N. Get lute, lamp, succulents, plastic dice and anticube. Put die, anticube and succulents in pocket. S. **Qmbz mvuf** and **tjoh Vsgbopsf Qfoesb**. S.

Empty Office and Cubical Rooms

(Don't enter opening to the east yet.) Get die. Roll die (till you get a **tjy**). E. D. Roll die (till you get a **gjwf**). E. Roll die (till you get a **uxp**). D. Roll die (till you get a **pof**). NW. Roll die (till you get a **gpvs**). D.

Treasure Room

Get all (treasures; drop any extra items you may be carrying, except the **ejf** and **boujdvf**). Examine pillar, machine and cube. Put **ejf** and **boujdvf po nbdijof**. Get **dvf** and **boujdvf po nbdijof**. (You're now faced with four exits: NW, NE, SW, SE. The correct one is found by looking at the **tjhot** on the **qjmmbs** and going in the direction that's **njttjoh** in the **cpy**. Or just save the game and choose an exit. If you die, restore and choose another until you find the right one leading to the White Room.)

White Room

NW. NW. D. Get **tvddvmfout** (should be in pocket). **Svc gffu** with **tvddvmfout**. D. SE. SE. E(4). Pull rope. E.

**Map Key:
Guild of Thieves**

- A : Coal
- B : Note
- C : Red ball, cue
- D : Cube
- E : Cage
- F : Box, needle, cotton
- G : Maggot
- H : Key
- I : Fish, night safe
- J : Poison, jar
- K : Champagne bottle, red bottle
- L : Flies, horseshoe
- M : Lute, gum
- N : Gloves
- O : Ebony and ivory keys
- P : Fingerbone, heart
- Q : Berries
- R : Coin
- S : Skin
- T : Coconut, succulents
- U : Magazine, grotty key, spade
- V : Skull, eye
- W : Pamphlet
- X : Boots
- Y : Pick
- Z : Mirror, plaque, abstract painting
- Z1: Diary, cauldron, satchet, anticube
- Z2-Z5: Colored dice
- Z6: Plastic die
- Z7: Treasures deposited in night safe

Treasures:

- 1 : Fossil
- 2 : Oil painting
- 3 : Diamond ring
- 4 : Plastic bag
- 5 : Designer dress, china pot
- 6 : Chalice
- 7 : Ruby
- 8 : Plectrum
- 9 : Incense burner
- 10: Ivory rhino
- 11: Statuette
- 12: Brooch
- 13: Mineral chips
- 14: Gem

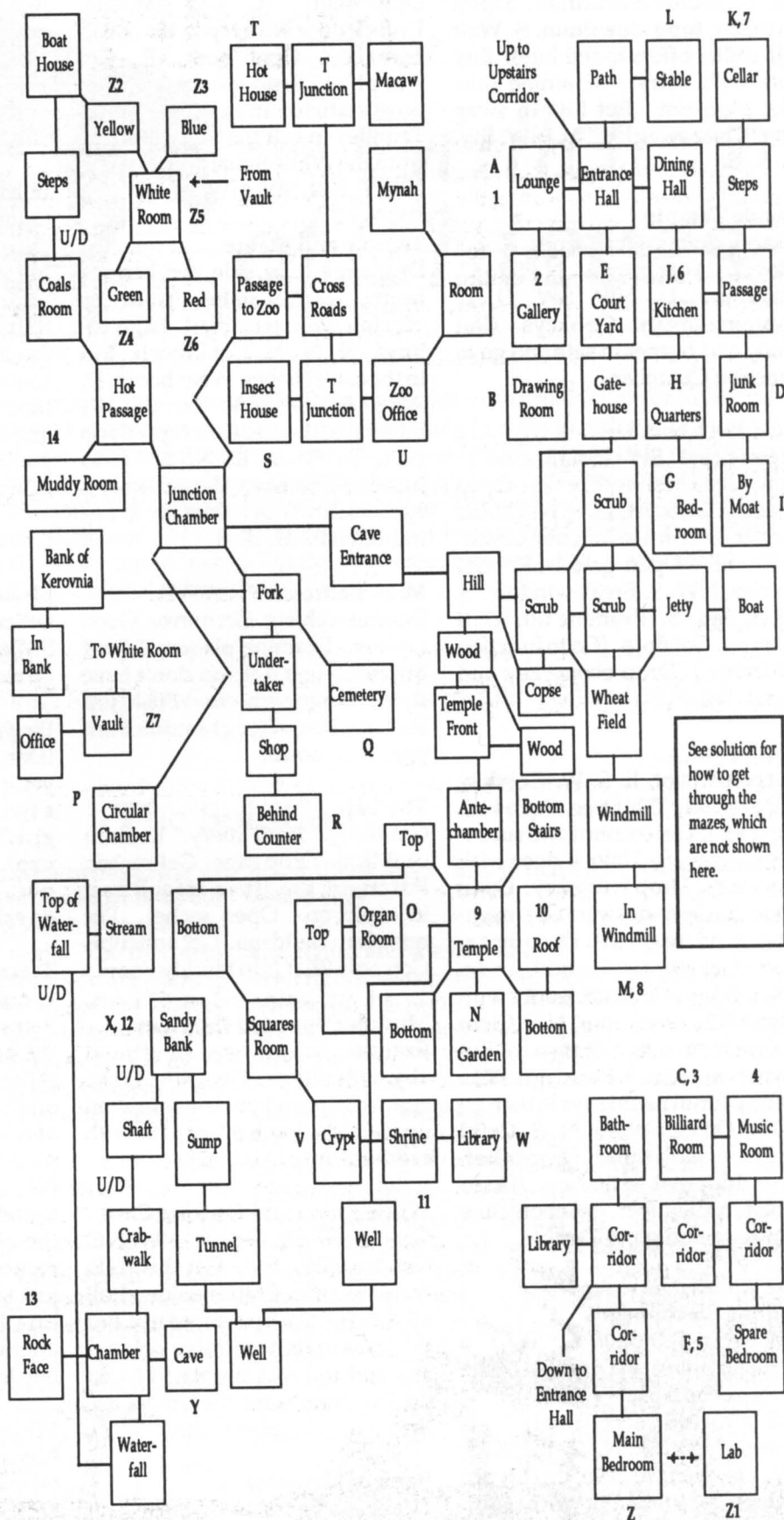

Jinxter

Thanks to the magical charms from the Bracelet of Turani, the inhabitants of Aquitania once enjoyed amazingly good luck. Now that the Green Witch has duped people into hiding the charms, the land is beset by disaster. By locating the charms (which enable you to cast some puzzle-solving spells of your own) and reassembling the Bracelet, you can subdue the Witch and restore Aquitania's good luck. You can also count on a rollicking good time, for the people you'll meet are genuine characters whose quirks and comments will keep you laughing and smiling through even the toughest puzzles. Much of the game's warped humor—demented puns, dry wit and absurd situations—is decidedly British in nature, making it a must for Monty Python fans. The well-written text outshines the graphics, and only key scenes are illustrated. An above average parser accepts full sentence and multiple commands. If you're looking for funny as well as fun, Aquitania is the place to go.

Type: Illustrated Text Adventure

Skill Level: Intermediate

Systems: C 64/128, ST, Amiga, Macintosh, Apple II (text-only), IBM (EGA and 640K required for graphics)

Company: Magnetic Scrolls

The Solution

On the Bus

Show ticket to inspector (when he says, "Tickets, please,"). Push button (after passing first stop). Get off (when doors open). Get keyring (you'll die). Read document. Drop document and ticket. Open gate. N. Unlock door with `jspo` key. Open door. N. NW.

In Your House

Look under bed. Get sock. (When phone rings, go to Library and answer it.) N. [Kitchen] Get tin opener. E. Get tablecloth.

In Conservatory

Unlock door with `jspo` key. Open door. N. Get gloves and `tdbufvst`. N. E. `Xbwf ubcmfdmpui` at bull. Drop `ubcmfdmpui`. SE. E. Get bottle. (Return home.)

Your Kitchen

Open fridge. Get milk bottle. Put `qmbtujd cpuumf` in fridge. Close fridge. Drink milk. Wait (15-30 times, until you can open the door, examine fluid and be told "you can't see any fluid.") Close fridge. Drop `qmbtujd cpuumf`. Put `pjm` in milk bottle. (Go to Boathouse.) Get mouse trap and can of worms. (Go to Xam's Front Garden.)

Xam's House and the Mouse

Unlock door with `svtuz` key. Open door. SW. W. Get matchbox and candle. S. SW. S. [Under Holly Bush] Listen to bird. N. NE.

N. E. Open trapdoor. `Xfbs tqfdubdmft`. D. Get cheese. U.

Put cheese on mouse trap. `Tfu usbq`. Drop trap.

(Go west, then wait 10-20 times, return and examine trap until you've caught a mouse.) Get mouse. (During this time the mailman will have knocked on the door. Go to the mailbox.)

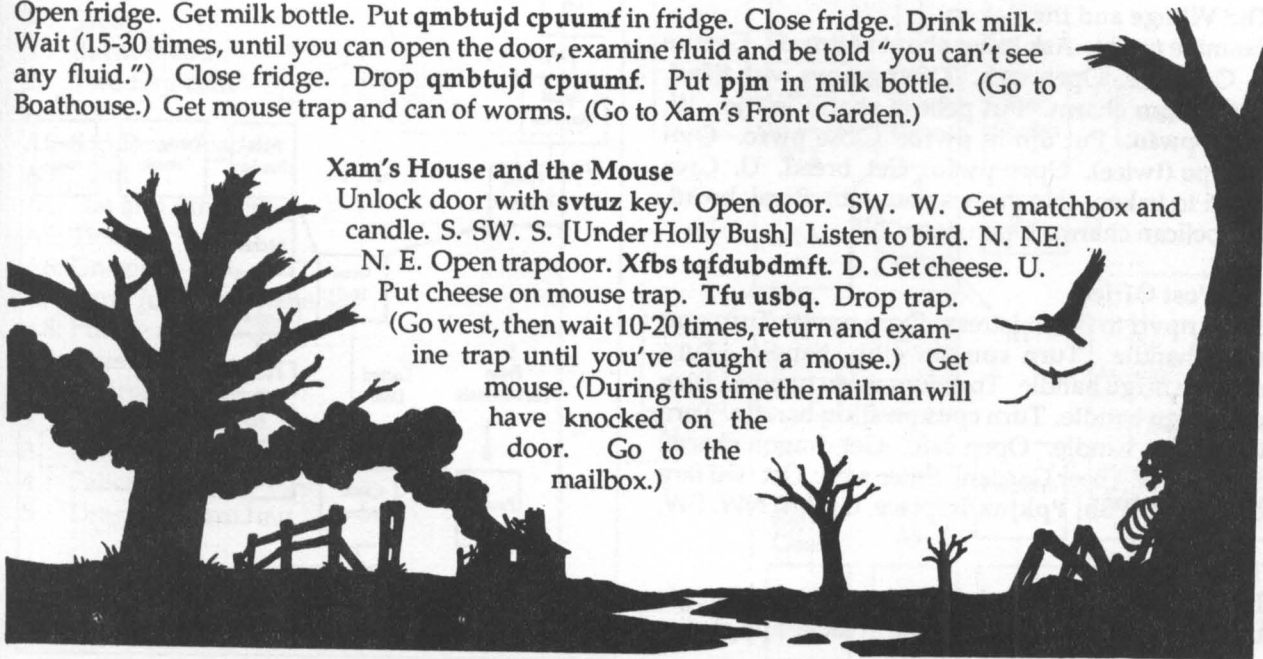

Xam's Mailbox

Open mailbox. Get note. Read note. Drop note. (Go to Xam's Study.) Get phone. Dial 300. (Go to mailbox and wait till mailman locks box, then return to house.) Get nbudi. Mjhiu nbudi. Mjhiu dboemf with nbudi. Ifbu qmbtujd lfz with dboemf (twice). (Go to mailbox.) Unlock mailbox with qmbtujd lfz. Get parcel. Open parcel. Examine parcel. Read note. Get charm. Drop parcel.

The Boathouse and the Crazy Gardener

Get bung. Put pjm on runners. Drop bottle of milk. Open door. S. Get sack. Get amethyst charm.

The Canoe and the Lagoon

Put cvoh in tpd1. Put tpd1 in hole. Put canoe in lagoon. Get paddle. Enter canoe. S (2). Get out. D. Open dbo pg xpsnt with ujo pqfofs. Empty dbo pg xpsnt on dirt. Dig dirt with tdfbufvst. Drop ujo pqfofs and tdfbufvst. E. E. Get mask, flippers, wet suit and aqualung. W. W. U. (Pagoda). Remove clothes. Wear mask, flippers and wet suit. Drop all but aqualung. Wear aqualung

Underwater in the Lagoon

N. D. NW. N. Open hatch. D. Close hatch. Push left button. Remove aqualung.

The Airlock, the Sacristy and the Chandelier

Turn wheel. Open door. E. D. Examine notecase. Get coin. Open door. U. W. [Airlock] Qvti sjhiu cvuupo. E. D. Xfbs brvbmvo. E. Wait (till xbufs gjmmt.) U. Get unicorn charm. D. W. U. W. [Airlock] Open hatch. U. S. SE. U. S. Remove aqualung, flippers, mask and wet suit. Get all. Drop aqualung, flippers, mask and wet suit. Wear clothes. Enter canoe. N. SW. Get out. S. NW.

The Village and the Bakery

Examine notice. Ask baker about notice. D. Get tin. E. Get sieve. Open sack. Tjfwf gmpvs with tjfwf. Get pelican charm. Put pelican charm in ujo. W. Open pwfo. Put ujo in pwfo. Close pwfo. Qvti cvuupo (twice). Open pwfo. Get bread. U. Give bread to baker. (He throws you out.) Break bread. Get pelican charm. Open door. NE.

The Post Office

Show npvtf to Postmistress. Drop npvtf. Turn upq sjhiu handle. Turn cpuupn sjhiu handle. Turn cpuupn mfgu handle. Turn upq mfgu handle. Turn upq mfgu handle. Turn cpuupn sjhiu handle. Turn upq mfgu handle. Open safe. Get dragon charm. SW. SE. N. [Beer Garden] Enter well. Get two ferg coin. U. S. [Pub] Ppkjnz fireplace. Get bti. NW. SW.

The Carousel

Put nof gfsh dpjo in slot. Ride unicorn. Eppgfs unicorn. Get saddle. Put saddle in sack. Eppgfs fire

engine. Drop all but can of worms and walrus charm. Get ladder.

The Clockmaker's Shop

Look in window. Knock on door. Throw dbo pg xpsnt at lamp. SW. Ppkjnz stool. Get stool. E. [In Weather Clock] Drop stool. Lean ladder against girder. W. NE. Get all. SW. E. Get on stool. Climb ladder. Jump north. [On the Platform] Wait (for Rain Weatherman to spin around on weather vane, or cast thingy). Get hat and umbrella. Hold onto Rain Weatherman. Eppebi. (A friendly cloud appears.) Ppkjnz cloud. D. Get on cloud. Eppgfs cloud.

The Train Station and Beyond

E. Buy ticket with uxp gfsh dpjo. E. E (into train). Show ticket to guard. Wait. Out. [On Mountain] Put saddle on unicorn. Get on unicorn. Eppgfs unicorn.

The Castle

D. E. N. E. D. Open door. N. Xblf Xam. Tie spqf to nbobdmft. Get nbudi. Mjhiu nbudi. Mjhiu dboemf with nbudi. Put dboemf in ibu. Put ibu under spqf. Enter hatch. Wait (for dboemf to burn through spqf). N. U. NE. Open door. E (2). Examine plastic blocks. Slide numbers in this order: 5, 8, 1, 6, 7, 2, 9, 5, 3, 4. Wear gloves. Get bracelet. Put charms on bracelet. Wear bracelet. W (2). SW. NW. U (2). Open door (right or left). N. Get crystal ball. D (2). SE. Look into ball (until you see Jannedor looking into gjsfqmbdf). Eppgfs ball. Put bti on ifbsui. Dmjnc vq dijnofz. (Wait for witch to enter.) Put csbdfmfu on xsjtu

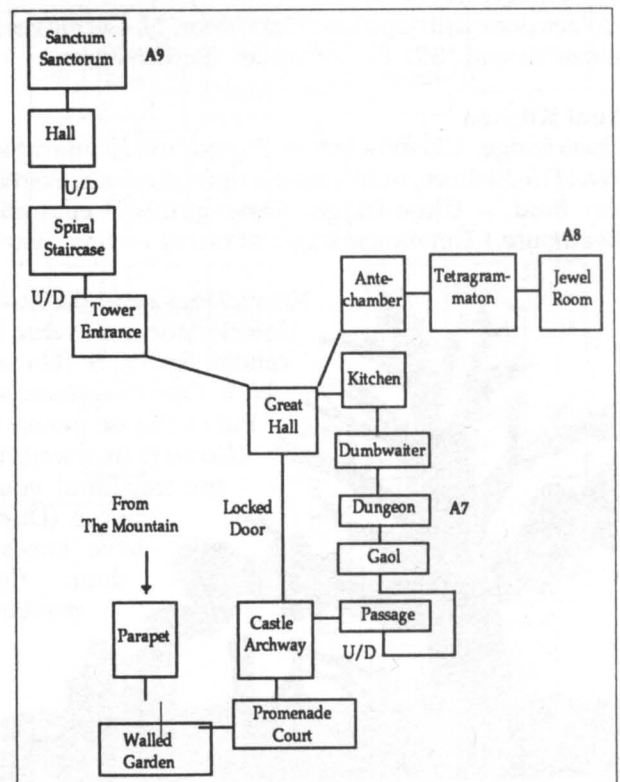

Map Key: Jinxter

- A: Keyring
- B: Socks
- C: Tin opener
- D: Tablecloth
- E: Gloves
- F: Secateurs
- G: Plastic bottle (oil)
- H: Milk bottle
- I: Mousetrap
- J: Can of worms
- K: Matchbox
- L: Candle
- M: Spectacles
- N: Cheese
- O: Mouse
- P: Phone number in note
- Q: Bung
- R: Canoe
- S: Paddle
- T: Diving gear
- U: One ferg coin
- V: Tin of dough
- W: Sieve
- X: Sack
- Y: Burnt bread
- Z: Two ferg coin
- A1: Ash
- A2: Saddle and ladder
- A3: Stool
- A4: Hat and umbrella
- A5: Ticket
- A6: Unicorn
- A7: Xam, rope and manacles
- A8: Puzzle and bracelet
- A9: Crystal ball
- 1: Walrus charm
- 2: Amethyst charm
- 3: Unicorn charm
- 4: Pelican charm
- 5: Dragon charm

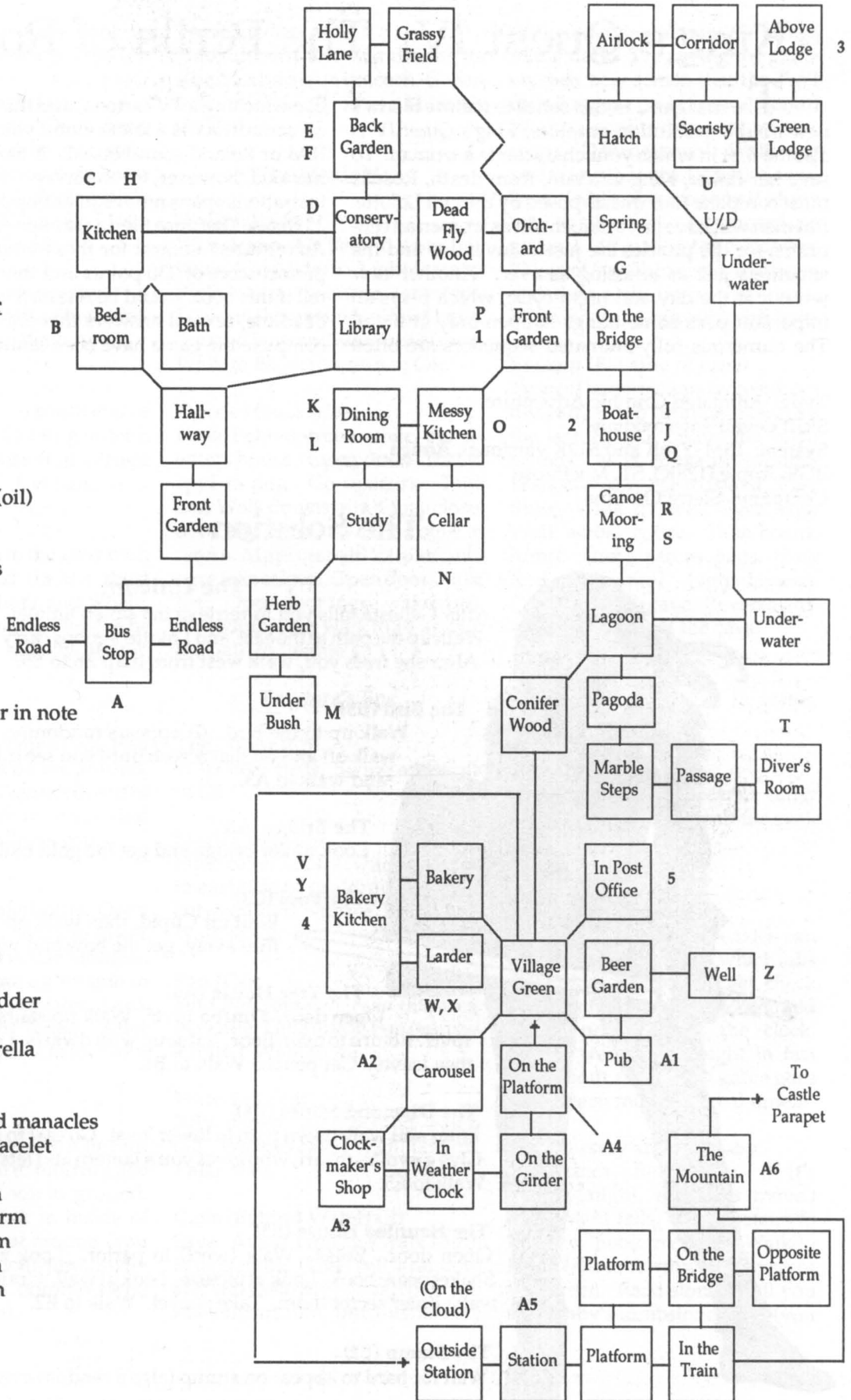

King's Quest IV: The Perils of Rosella

The first game in this series to feature Sierra's new double-resolution graphics, *King's Quest IV* is also the first in which your character is a woman. To save her father, King Graham, from death, Rosella must complete four quests posed by the evil Lolotte. But men will have just as much fun as women adventurers, for the puzzles are just as inventive and the situations just as amusing as ever. Another new wrinkle is the day and night cycle, which plays an important part: some things happen only at night. The numerous fully-animated sequences are often

like watching a TV cartoon, and the 40-minute musical soundtrack is a knock-out if you have an Ad Lib, IBM or Roland sound board. A hard disk is recommended, however, for the array of richly detailed illustrations spans nine regular floppies and four 3-1/2" disks. (Because Sierra was sponsoring a "Master Adventurer" contest for those who finished with a perfect score of 230 points and there was no way to tell if this book would be released before the contest deadline, several answers that are not necessary to complete the game have been omitted.)

Type: Animated Graphic Adventure

Skill Level: Intermediate

System: IBM (256K and 512K versions), Amiga, IIGS, Apple (128K), ST, Macintosh

Company: Sierra On-Line

The Solution

The Unicorn

After Genesta tells you to retrieve the stolen amulet, walk to map B6. Walk up the path to the east, and Lolotte's goons carry you to her castle. After she frees you, walk west from map B6 to B5.

The Bird (B5)

Walk up to the bird. (It appears randomly. If not on-screen, walk off and on that screen until you see it.) Take the worm and walk to A3.

The Bridge (A3)

Look under bridge and get the gold ball. Walk to C3.

The Pool (C3)

Wait for Cupid, then walk up to him. After he flies away, get the bow and walk to A4.

The Tree House (A4)

Open door. Dmfbo ipvtf. Walk up stairs to east. Dmfbo ipvtf. Return to main floor. Eat soup with dwarfs. Look at table (after they leave). Get pouch. Walk to B4.

The Diamond Mines (B4)

Enter and walk down path to lower level. Go east to dwarf by bucket. Give qpvd1 to dwarf, who gives you a lantern and lets you keep pouch. Walk to E5.

The Haunted House (E5)

Open door. Enter. Walk (west) to parlor. Look at shelves. Take Shakespeare book. Look at picture. Look at wall. Gmj q mbudi on west wall. Enter secret room. Take shovel. Walk to E2.

The Stump (E2)

Wait for bard to appear on stump (also a random event, like the bird).

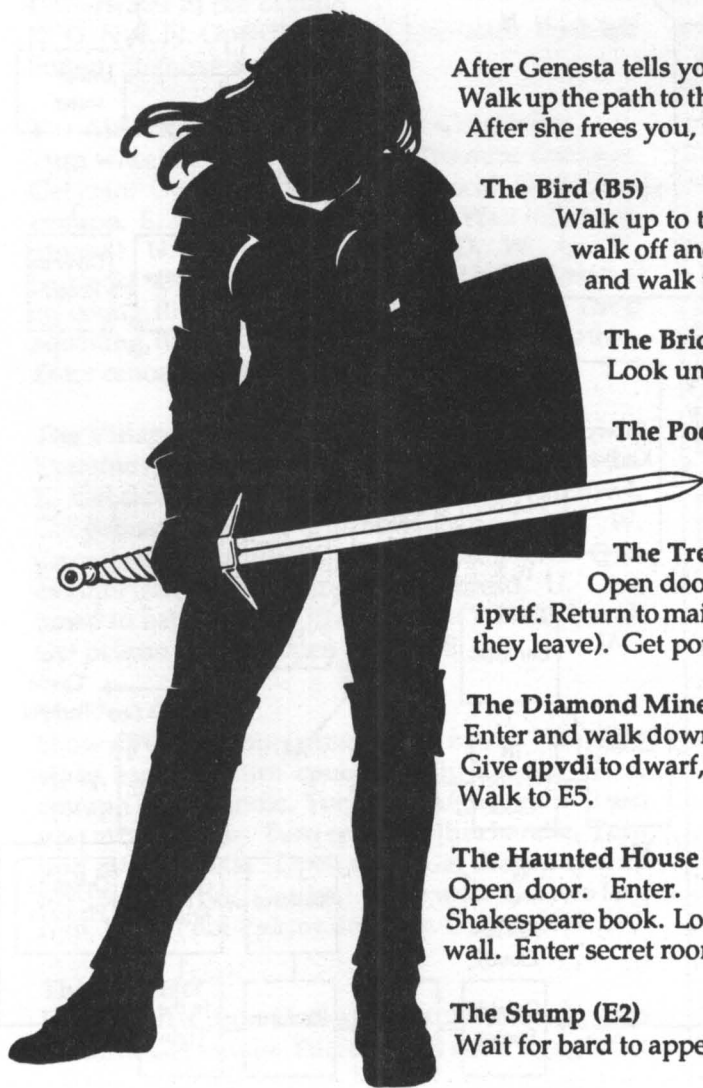

Walk up to bard. Give book to bard. Take lute. Walk to D1.

Fisherman's Wharf (D1)

Walk to end of pier. Open door, enter house (after man returns to house). Give **ejbnpoet** to man. (He gives you a fishing pole.) Walk to end of pier. Bait hook. Fish. Catch fish. Walk to A2.

The Unicorn (A2, or nearby)

Look for the unicorn. Shoot unicorn. Pet unicorn. Walk to E3.

The Pond (E3)

Look at pond. Go to south end of pond. Drop ball. Get frog (after it retrieves ball). Kiss frog (Prince gives you crown). Get ball.

The Beach (C1)

Save game. Swim to the west until you see an island (in the third screen). Avoid shark and whale, which are randomized and can be avoided only by quickly getting off the screen.

Genesta Island

Walk around beach until you find a **qfbdpdl gfbuifs** on the ground. Take **gfbuifs**. Walk to north end of island. Swim north until you find whale, which swallows you.

Inside Whale

Swim to bottle. Take bottle. Open bottle. Read note. Walk to lower left-hand corner of whale's tongue. Walk **ejbhpobmmz** up tongue to top of tongue, left of center. Look at mouth. **Ujdlmf** uvula. After being sneezed from whale, swim to island.

Deserted Island

Stand east of the pelican; if he flies away, wait for him to return. Give **gjti** to pelican. Look at ground. Take whistle. Walk to inside of boat's bow. Look at ground (you get a bridle). **Cmpxixjtumf**. Swim to dolphin. Ride dolphin (who takes you to shore).

The Unicorn (A2)

Find unicorn and stand near its **ifbe**. Put bridle on unicorn. Get on unicorn. (You'll ride to Lolotte's Castle.)

The Magic Hen

Waterfall (A6)

Xfbs dspxo. Go behind waterfall. Look. Take board. Light lantern. Walk into cave; stay near entrance. Look at the ground. Take bone. Turn off lantern. Swim out of cave. Walk to B4, then south to C4.

Ogre's House (C4)

Hide behind trees while ogress enters house. Open door. Throw **cpof** to dog. Go upstairs. Take axe. Walk downstairs. Open closet door and enter. Wait for ogre to return. **Mppluispvhilfzipmf** until ogre falls asleep. Open door. Take hen. Open door (ogre wakes up). Run south, then walk to B6 and up the path to Lolotte's.

Pandora's Box

The Forest (C5)

Walk near trees. Swing ax. Walk to C6.

Skull Cave (C6)

Enter cave. Look at witches. Walk to east side of cauldron. Walk to between two witches. Take eye. Walk to C2.

Pan (C2)

Find Pan somewhere in this area. Play lute. Give lute to Pan (you get a flute.) Walk to A6.

Waterfall (A6)

Xfbs dspxo. Hop behind waterfall. Walk to cave. Light lantern. Enter cave.

Cave (Behind Waterfall)

Save. Avoid Troll and walk south to next room. (The Troll is random and walks slowly enough that you can outrun him, but this is very

difficult while walking into things in the dark. Try saving the game on each new screen that the Troll didn't appear on.) [Second Room] Walk to south, then east to next room. [Third Room] Walk due east to fourth room. [Fourth Room] Save. Walk about one-half of the way to the east. Lay board on ground. (If you get the message "Not yet," walk to east.) Walk east and then walk up to small hole. [Fifth Room] Crawl through hole.

Swamp (Far side of cave)

Turn off lantern. Stand across from lily pad. Jump (until you land on the last lily pad before the small island). **Mbz cpbse** on ground. Walk across **cpbse** to island. Play flute. Walk to tree. Take fruit. Walk across **cpbse**. Take board. Jump. Jump across pads. [East End of Swamp] Light lantern. Crawl through cave. Reverse previous steps to exit the cave.

Waterfall

Turn off lantern. Get in water. Swim under waterfall.

Skull Cave

Enter cave. Take scarab (after witches offer you scarab for eye). Walk to E5.

Nighttime and the Haunted House

The Haunted House puzzles can only be solved at night, which falls at 9 PM. If it's not dark yet, check the time by entering the Haunted House and reading the clock. (While waiting for night in fast mode, four minutes of game goes by for each minute of real time.)

The Nursery and the Baby

Open door. Read clock. (If it's already night, skip this move.) After night falls, walk upstairs to nursery. Look in cradle. Walk to E4. Walk to northwest corner of the screen. Read stone (until you see a baby's tombstone). **Ejh** (you

find a **sbuumf**). Return to house, open door. Go to nursery. Drop **sbuumf** in cradle. Go downstairs (after you hear moaning).

The Miser's Ghost

Look ghost. Go to West Cemetery. Walk to southwest corner. Read stone (until you see one for a **njtf**). Dig (you find **hpme dpjot**). Return to house. Give **dpjot** to miser. Go to east bedroom on second floor (after you hear sobbing).

The Woman's Ghost

Look ghost. Go to East Cemetery. Walk to southwest corner of screen, left of the cross. Read stone (until you see one for a "woman who lost her love"). Dig (you find a **mpdlfu**). Return to house. Go to east bedroom. Give **mpdlfu** to ghost. Go downstairs (after hearing noise).

The Soldier's Ghost

Look ghost. Go to West Cemetery. Go to southeast corner of screen, second tombstone from right. Read the soldier's stone. Dig (you get a **nfeb**). Return to house. Find ghost. Give **nfeb** to ghost. Follow boy to east bedroom. Climb ladder.

Attic

Look ghost. Climb on ladder. Go to East Cemetery. Go to northwest corner of screen and read young boy's stone. Dig (you find **upz ipstf**). Return to house. Go to attic. Give **upz** to ghost. Open chest. Look in chest (get sheet music). Climb ladder. Go to secret room on the main floor. Climb stairs.

Organ Room

Walk between bench and organ. Sit. **Qmbz tiffu nvtjd**. Look in drawer. Take key. Stand. Go to East Cemetery. Walk to crypt. Unlock door. Open door. Walk into crypt.

The Crypt

Take rope. Climb on ladder. Take box. Climb ladder. Leave crypt. Close door. Lock door. Walk to B6 and return to Lolotte.

The Talisman

Edgar's Room

Look at rose (after Edgar puts it under door). Take key (from rose). Unlock door. Open door. Walk down steps.

Bottom of West Tower

Walk to east through door and go to Kitchen. Go to east cabinet. Open cabinet. Take all (the things Lolotte took from you). Go to Throne Room.

Throne Room

To avoid guard, **xbml bspvoe cmvf svh**. Walk through east door.

East Tower

Climb steps to top. Unlock door with gold key. Open door.

Lolotte's Bedroom

Shoot arrow. Take talisman. Exit castle.

Castle Courtyard

Enter stable. Walk down path to B6, then to E6.

East Cemetery

Walk to crypt. Unlock door. Open door. Walk into crypt.

The Crypt

Take rope. Climb on ladder. Climb ladder. Exit crypt. Close door. Walk to beach (C1) and swim west **uisff** screens.

Genesta Castle

Walk to main door. Open door. Walk up steps. [Bedroom] Give Talisman to Genesta. (She takes you outside). Go home to save King Graham.

Map Key: King's Quest IV

These objects' precise locations are not shown on the maps, just the screen where each is found.

- A: Worm
- B: Gold ball
- C: Bow
- D: Pouch (diamonds)
- E: Lantern & pouch
- F: Shakespeare book & shovel
- G: Lute
- H: Fishing pole & fish
- I: Unicorn
- J: Frog & crown
- K: Peacock feather (This appears randomly at any of the beaches, but is most often found on the northeast or southeast one.)
- L: Pelican & whistle
- M: Board
- N: Bone
- O: Axe & hen
- P: Eye
- Q: Flute
- R: Fruit
- S: Scarab
- T: Cradle & baby
- U: Tombstones, locket & toy horse
- V: Tombstones, rattle, gold coins & medal
- W: Sheet music
- X: Key
- Y: Box

King's Quest IV

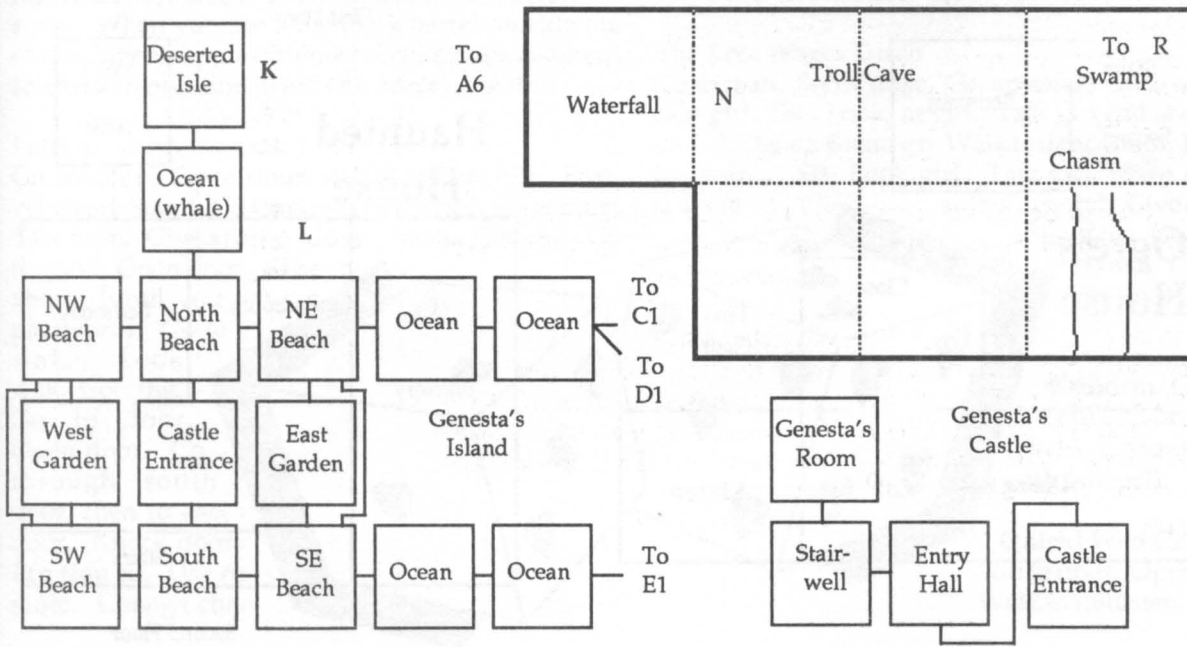
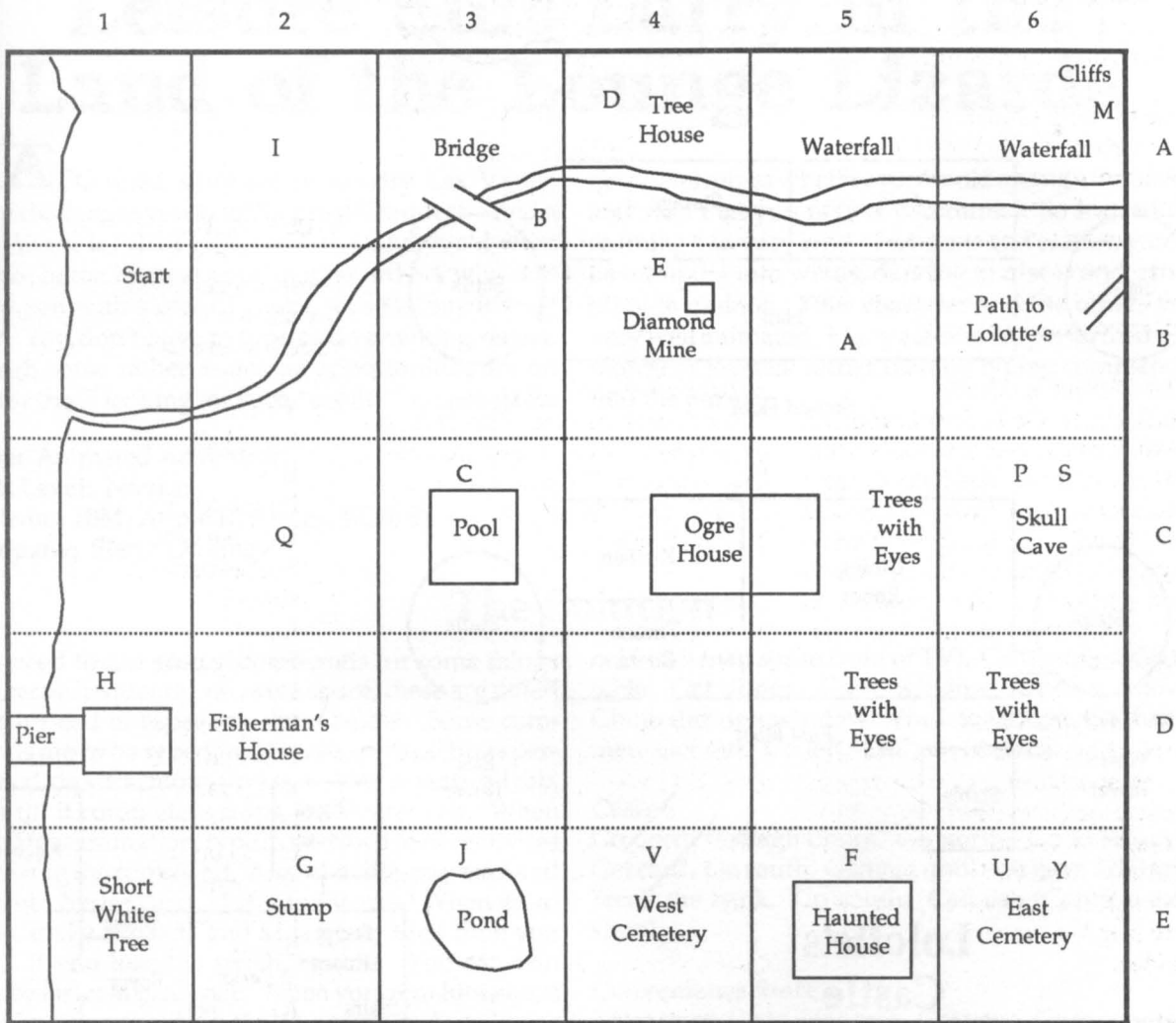

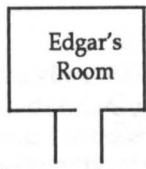

Third Floor

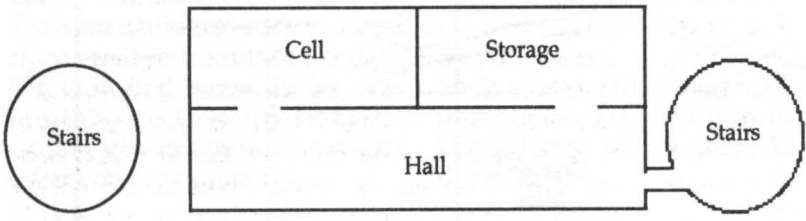
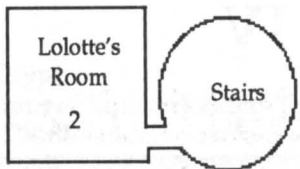

Second Floor

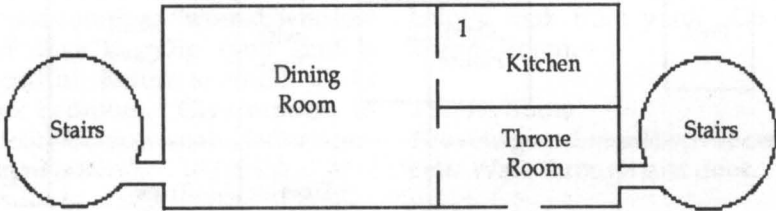

First Floor

West Tower



Path



East Tower

Lolotte's Castle

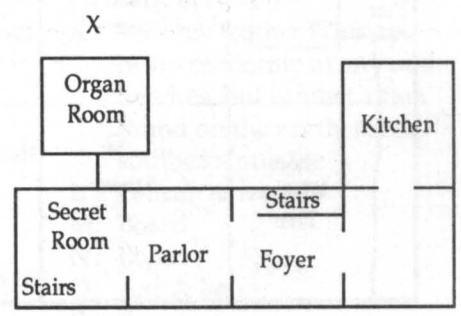

First Floor

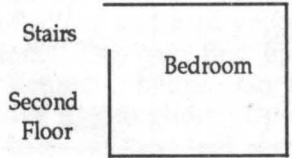

Ogre's House

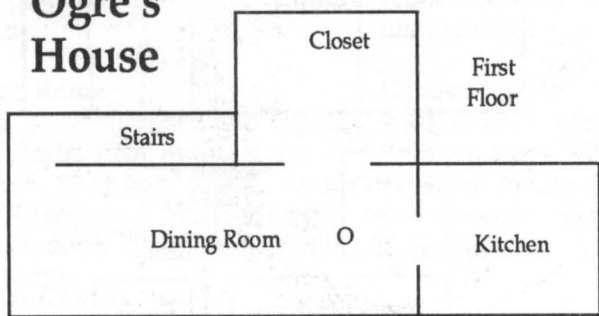

First Floor

Haunted House

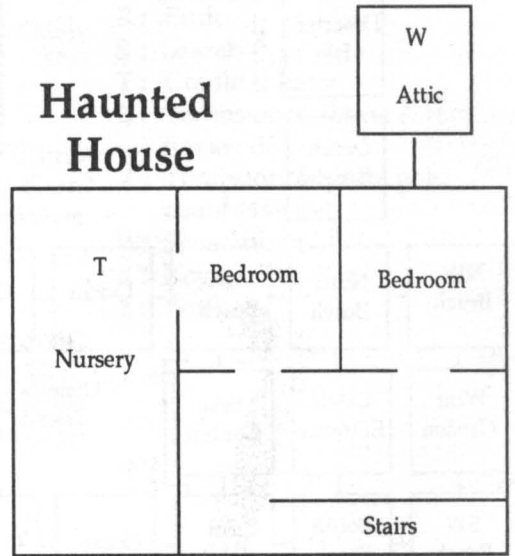

Second Floor

Leisure Suit Larry in the Land of the Lounge Lizards

A PG-rated story set in tawdry Las Vegas, *Larry* challenges you to fulfill a real-life quest—find a girl. Vegas is full of girls, some the kind you'd want to take home to meet your mother, others who will leave you with a case of...well, let's just say it's not beer. You don't have to type or do anything risqué, though some rather salacious opportunities are on tap for those looking for such "action." (A pre-game

quiz determines whether you're old enough for *Larry*, and won't let you play if you flunk.) So instead of roaming a fantasy land of dragons and castles, you'll be bumping into winos, dancing in discos and gambling in casinos. Your character and the others are very well animated. Many actions are performed via mouse or joystick rather than by typing commands into the parser.

Type: Animated Adventure

Skill Level: Novice

Systems: IBM, Apple II, Amiga, IIGS, ST

Company: Sierra On-line

The Solution

You need to use special commands for some things that recur frequently. To save space, these are noted here instead of repeating them below. Some commands are to be typed in; others explain actions performed via stick, mouse or keys. After saying call cab, wait till it completely stops, then enter cab. When asked for destination, type in the word in parentheses following the command. After the ride, pay man and get out. Never carry xjof into the cab. When gambling, make \$20 bets and save game each time you win. If you lose too much, restore. You can win money faster at blackjack. When you get a hint about your breath, use spray. If it's used up and you're far from the end, take \$50 to the store and ask the clerk for some. When you see a man in a barrel outside the casino, buy his apple (this may occur at various times, so check in occasionally if you don't have it).

Lefty's

Go to door. Open door. Walk to bar. Sit. Beer. Whiskey. Stand. Go through north door. Go to bum. Talk bum. Give xijtlfz. Go to table. Get rose. Go to door. Open door. Sfbe
xbmm (until you get password). Go to sink. Look sink. Get ring. Go to door. Open door. Go through south door, then to east door. Knock door. Lfo tfou nf. Use remote. Change chan-

nel (until man sits in front of TV). Go upstairs. Go to table. Get dboez. Go to window. Open window. Climb through window. Walk to ladder. Get hammer. Get out. Go left. Call cab (casino).

Casino

Go north through doors. Go north. Go to ashtray. Get card. Go south. Gamble until you have \$250 and break the bank. Go south. Call cab (Convenience store).

Convenience Store

Enter store. Go to wine rack. Get wine. Go to counter. Buy wine. Leave store. Give wine to bum. Walk east.

The Lost Wages Disco

Go to man. Show dbse. Go upstairs. Go to seat beside girl. Sit. Look at girl. Talk girl (till she gives name). Dance. Stand up. Walk to dance floor. Return to seat. Sit. Look girl. Talk girl. Give dboez. Give sptf. Give sjoh. Give npofz.

Stand up. Go south. Tbwf. Call cab (casino).

Casino

Go north. Gamble until you break the bank. Go south. Call cab (chapel).

Quicki Wed Chapel

Go to door. Open door. Walk to minister. Marry



Fawn. Go south. Call cab (convenience store).

Convenience Store

Go to phone. Dial phone. 5558039 (op ebt). Wine. Honeymoon suite at casino hotel. Call cab (casino).

Casino

N. N. Enter elevator. Press four. Go to door with heart on it. Knock door. Go to wine. Qpvs xjof. Lie in bed. Dvu spqf with lojgf. Get rope. Go to door. Open door. Enter elevator. Press one. S. Gamble at least \$50. S. Call cab (Lefty's). (Some computers will accept Leftys).

Lefty's

Go to door. Open door. Go to east door. Knock door. Lfo tfou nf. Go upstairs. Go to window. Climb out window. Ujf spqf to railing. Ujf spqf to me. Get qjmmt. Break glass with ibnnfs. Get qjmmt. Go to fire escape. Untie rope. Save. Go to ladder. Exit bin. Go left. Call cab (casino).

Casino

(You must have bqmqf by now.) N. N. Enter elevator. Press fjhiu. Go to girl. Look at girl. Give qjmmt. Wait for girl to leave. Press button. Go to east elevator. Enter it. W. Go to hot tub. Undress. Look at Eve. Give bqmqf to Eve.

Map Key: Leisure Suit Larry

- A: Beer
- B: Whiskey
- C: Rose
- D: Password
- E: Candy
- F: Hammer
- G: Card
- H: Apple
- I: Wine
- J: Girl
- K: Rope and phone number
- L: Pills
- M: Condoms
- N: Rubber doll

(For more points, experiment with dpoept and epmm.)

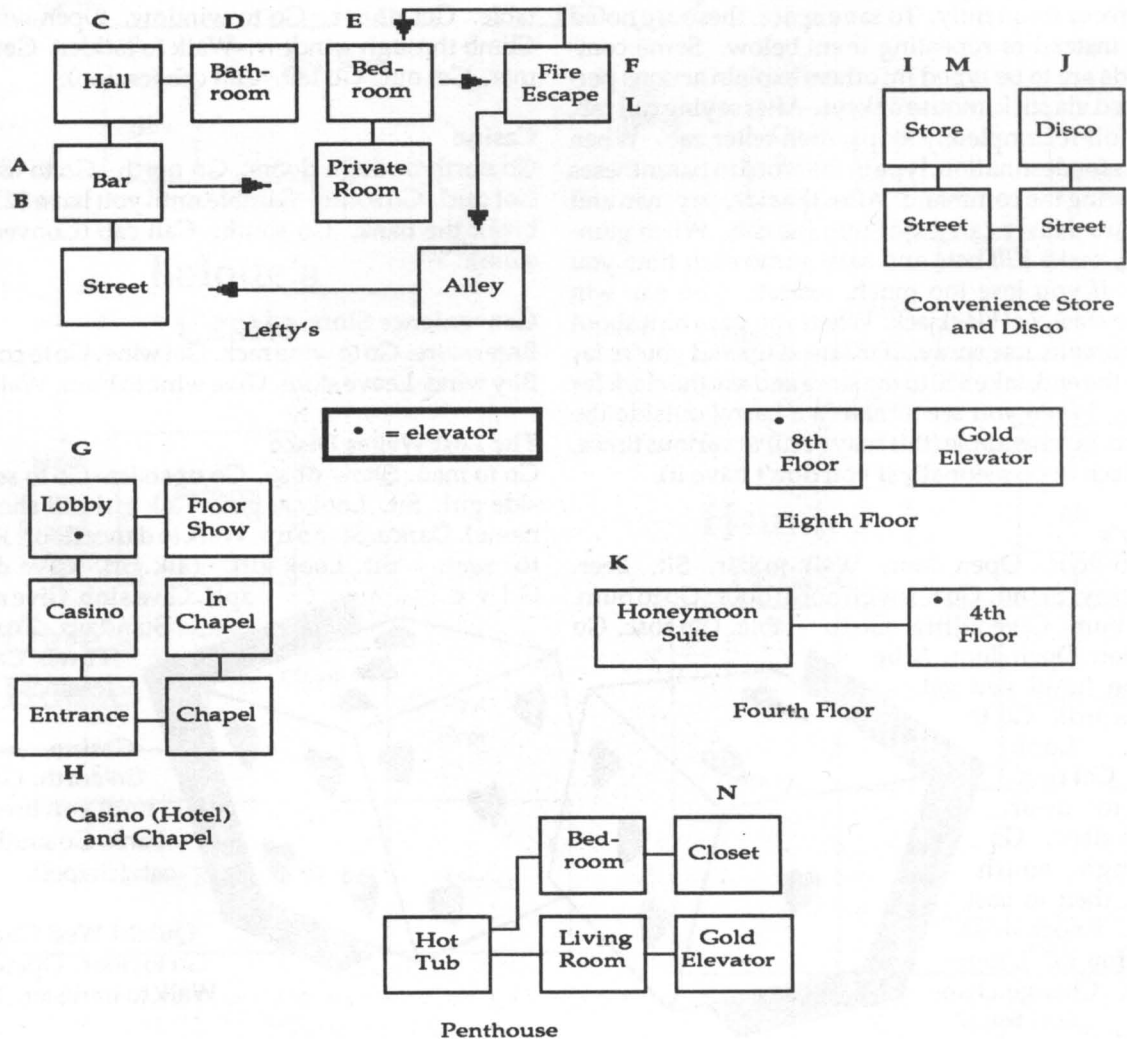

Leisure Suit Larry II: Looking For Love in Several Wrong Places

Larry's latest escapades take him (and you) on a whirlwind tour of southern California that includes a stroll around Los Angeles, a voyage on a cruise ship and sunbathing at a nude beach on a remote island. Instead of just trying to "get lucky" this time, Larry's initial goal is to win a million dollars at the Lottery and a dream date on "Dating Connection." A subplot makes the action even more interesting: you must sidestep KGB agents while striving to foil the evil plan of Dr. Nonookee, a James Bond-style villain out to take over the world. It's not as "adult-ori-

ented" as the first game, though you'll still find some racy dialogue with the program set for maximum lewdness. Sierra's new, improved parser understands more words than in previous games, and the double-resolution graphics really make a difference. The animation is top-notch—and though there's not as much music as in *King's Quest IV*, it's just as impressive if you have an Ad Lib, Roland or IBM sound board. Most important, the wacky sense of humor that made the first game such a hit is even wackier the second time around.

Type: Animated Adventure

System: IBM (512K required; Turbo PC, 8 MHz or faster recommended); Amiga, IIGS, ST, Macintosh, Apple (128K)

Skill Level: Intermediate

Company: Sierra On-Line

The Solution

Los Angeles

Eve's House (D1)

Walk into garage. Walk east in garage until zpvdbo'u cf tffo. Take dollar bill. Walk to KROD (A1).

KROD (A1)

Look (note info for future reference). Walk to dumpster (A3).

Dumpster (A3)

Walk to hole in fence. Look through hole. Walk to Quickie Mart (A4).

Quickie Mart (A4)

Talk to girl. Buy Lotto Ticket. Enter any six three-digit numbers. Walk to KROD (A1).

KROD

KROD (A1)

Enter building.

Lobby (B2)

Show ujdifu to girl. Write down the numbers given to you by the receptionist. (Girl asks for your ticket numbers.) Repeat the numbers given by receptionist. Enter the Green Room through the north door.

Green room (A2)

Sit down on bench. (Man enters.) Gpmpmx nbo through west door.

The Dating Connection

Enter anything when asked questions. (You win the game.) Return to the Green Room.

Green Room

(Man gives you cruise ticket.) Sit on bench. (Woman enters.) Follow woman through east door.

Lotto Room

(You win a million a year for life, get money from girl and walk back to lobby.)

Lobby

Leave building. Walk to Eve's house (D1).

Los Angeles

Eve's house (D1)

Look in trash (uxjdf). Take passport. Walk to Century Plaza (C2).

Century Plaza (C2)

Look man. Walk to Molto Lira (B2).

Molto Lira (B2)

Read sign. Take swimsuit at back of room. Buy swimsuit at front of counter. Walk to drug store (B4).

Drug store (B4)

Walk to west side of far left shelf. Look shelf. Take lotion. Buy lotion. Walk to Quickie Mart (Map A4).

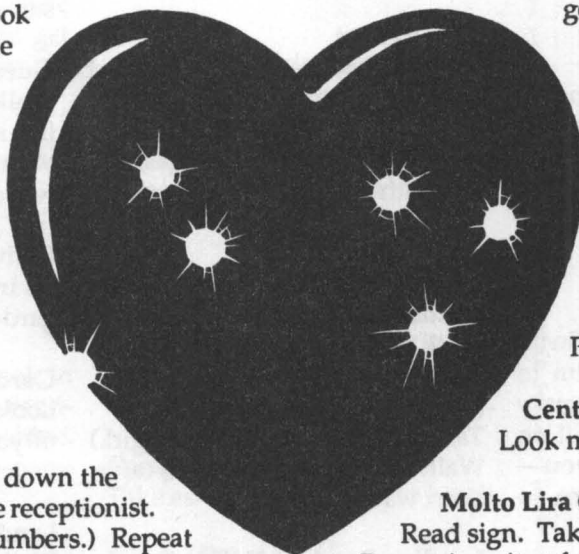

Quickie Mart (A4)

Walk to soda dispenser. Take soda. Buy soda. Walk to barber shop (D3).

Barber shop (D3)

Talk to man. Sit in chair. Hfu ibjsdvu. Walk to music store (B2).

Music store (B2)

Talk to girl. Get microfilm. (Look-alike KGB agent shows up.) Walk to dock (D4).

Dock (D4)

Give ticket to man. (Note: Deck F, Cabin 1.) Climb ramp to boat.

S. S. Love Tub**Lower Deck**

Walk east to enter Larry's cabin.

Larry's Cabin

Take fruit. Read note. Walk to east side of room. Open door. Go east into Mama's cabin.

Mama's Cabin

(Don't get too close unless you have saved the game and want a laugh.) Listen to Mama's speech. Walk west to Larry's room.

Larry's Cabin

Close door. Xfbs tvju. Walk south to leave room.

Lower Deck

Walk west to stairs, then up uxp levels.

Top Deck

Leave steps and walk east to pool area.

Pool Area

Walk into pool. Swim. Ejwf. Swim to bottom. Take top. Swim to surface. Leave pool. Walk to empty deck chair. Use mpujpo. Sit on deck chair. (Girl talks to you—ignore her.) Stand. Return to Larry's cabin.

Larry's Cabin

(Save game.) Open door on east wall. Enter Mama's cabin.

Mama's Cabin.

Open nightstand. Look in nightstand. Take kit. (If mama appears, restore game and try again.) Leave room.

Larry's Room

Wear clothes. (Leave and don't return; after several trips, mama gets you.) Return to top level and go all the way west.

Barber Shop

Walk to chair. Sit down. Get xjh. Walk east, then all the way up the eastern steps

Bar

Walk to west end of bar. Look. Take dip. (Epo'u psefs esjol.) Leave bar.

Top Deck

Go to west set of stairs and walk up to bridge.

Bridge

Walk to east side of room. Npwf iboemft (starts lifeboat drill). Walk back to eastern set of stairs.

Top Deck

Walk up to green line (halfway from top deck to bar) and go west to lifeboats. Get in lifeboat.

On Lifeboat

(The lifeboat leaves, and you must perform the next two steps before the scene changes.) Xfbs xjh. Fbu ejq. (After the scene changes, you fish with sewing kit, then reach an island.) Swim ashore.

The Island**Landing Beach (A2)**

Walk west to nude beach.

Nude Beach (A1)

Talk to woman. (Don't follow girl.) Walk east to landing beach (after short wait).

Landing Beach (A2)

Walk south.

Garden (B2)

(You wander through the garden.)

Restaurant (C1)

Talk to man. Tip the man. Sit in the chair. Walk to the bar. Look at the food. Take the knife. (Epo'u fbuzpvs gppe.) Leave the restaurant.

Garden (B2)

(You wander around.)

Guest Room (C2)

(Epo'u gpmmpx nbje.) Look in the nightstand. Take the matches. Walk into bathroom. Take the soap. Leave the room.

Garden (B2)

(You wander around.)

Barber shop (C3)

Sit in the chair (you get blonde hair). Leave barber shop.

Garden (B2)

(You wander around some more.)

Landing Beach (A2)

Walk west to nude beach.

Nude beach (A1)

Look at the rocks. Ublf cjljoj cpuupn. Walk east to landing beach.

Landing Beach (A2)

Walk south to garden. (Repeat steps to get to guest room.)

Guest Room (C2)

Walk behind bathroom into dressing area. Xfbs cjljoj. Stuff top with tpbq. Back to garden and wander to barber shop.

Barber Shop (C3)

Sit in chair (hfu xbyfe). Back to garden.

Garden (B2)

Look at flower. Take flower (wait till you're close to the palm in center to get the flower.)

Landing Beach (A2)

Walk east to KGB beach.

KGB beach (A3)

Walk past KGB agents.

Cliffs (A4)

Cross cliffs. (You get a free point each time you fall but lose them at the end of the game.) You see the airport. Dibohf dmpuift before scene changes.

Airport

Terminal entrance (D2)

Walk up to Krishna. Give gmpxf to man.

Counter (C2)

Walk west to waiting area.

Waiting Area (C1)

Go north into barber shop.

Barber Shop (B1)

Sit in chair (get haircut and conditioner). Return to counter area and go east to customs.

Customs (C3)

Walk up to customs agent. Show qbttqpsu. Walk east through short door.

Security Area (C4)

Walk to conveyor belt. Take bag as it passes by (repeat till you get the bag with a bomb and you go back to ticket counter).

Ticket Counter (C2)

Stand in line (bgufs cpnc fyqmpft). Talk to girl (you get ticket). Walk east to Customs.

Customs (C3)

Show qbttqpsu. Walk east to security area.

Security Area (C4)

Walk east to snack bar.

Snack Bar (C5)

Read sign. Buy special. Look in food. Take pin. Walk to top vending machine. Look at machine. Cvz jotvsbodf (you get a parachute). Get on walkway.

Gate (A5)

Look at the counter. Take the pamphlet. Give the ticket to the man (you walk through north door and into plane).

Front Section (A1)

(You give the ticket to the woman, then walk into the middle section.)

Middle Section (A2)

Look at seat. Take bag. Stand. Sit. Give qbnqimfu to man (bgufs if ubmlt up zpv). Stand. Walk to the rear section.

Rear section (A3)

Walk to back of plane. Look at the doors. Walk to south side of plane. (There's a door here but you can't see it.) Wear parachute. Qjdl mpdl. Turn handle. Open door (you are pulled from the plane). Pull ripcord (quickly!) (You get stuck in a tree.) Use lojgf.

Jungle

Landing site (A1)

Look at the ground. Take stick. Walk southwest, just north of bush. (Bwpje the tree; it dpoubjot ljmmfs cfft.) Crawl. Walk south.

Python (B1)

Walk south (until snake starts to move). Use tujdl (quickly!). Walk east to swamp.

Swamp (B2)

(Tbwf hbnf.) Walk east across light yellow pattern.

River (B3)

Walk to edge of river and swing on vine. (This must be quickly executed three times, so use F3 key.) Release vine. Take vine. Walk east to beach. (Girl takes you to chief in Native Village).

Native Village

Chief's hut (F1) and Chasm (E1)

(You follow chief north to chasm.) (Listen to chief.) Walk south to chief's hut, then east to campfire.

Campfire (F2)

Take ashes. Walk south to beach.

Beach (G2)

Take sand. Return to chasm area.

Chasm (E1)

(Save game.) Mppl usff. Walk

north to the end center of the path. Throw vine. (If unsuccessful, try from a different location.) Walk north (after you cross the chasm).

Glacier (C1)

Throw tboe (or btift) on ice. Walk north to land bridge.

Land Bridge (B1)

Walk north across land bridge.

Volcano (A1)

Walk near center of screen by crevice. Open upojd. (You must be in the correct location, stated above and shown on map.) Stuff bjstjdl cbh in upojd. Mjhiu bjstjdl cbh with nbudift. Drop upojd in crevice. Walk into elevator.

Map Key: Leisure Suit Larry II

- A: Dollar bill (garage), passport (in trash)
- B: Note
- C: Lotto Ticket, soda
- D: Winning lottery numbers (receptionist)
- E: Cruise ticket (man)
- F: Swimsuit
- G: Lotion
- H: Haircut, wig, wax job, haircut, tonic
- I: Microfilm
- J: Fruit, note (Larry's Cabin)
- K: Top (bottom of pool)
- L: Kit (nightstand)
- M: Dip
- N: Handles for lifeboat drill
- O: Lifeboat
- P: Food, knife
- Q: Matches (nightstand), soap (bathroom)
- R: Bikini bottom
- S: Flower
- T: Krishna
- U: Bag with bomb (conveyor belt)
- V: Ticket
- W: Pin (in food), parachute (top vending machine)
- X: Pamphlet
- Y: Bag (seat)
- Z: Ashes
- Z1: Sand
- Z2: Stick

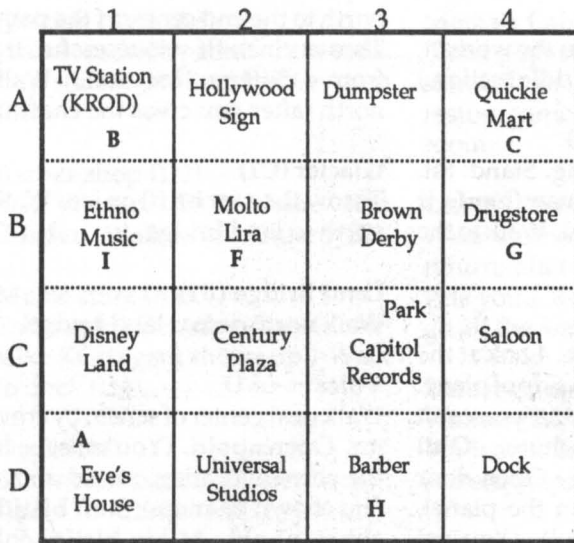

Los Angeles

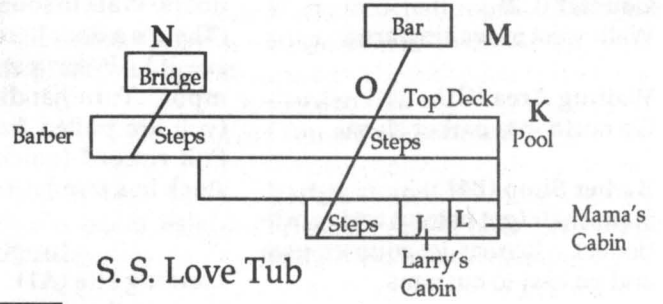
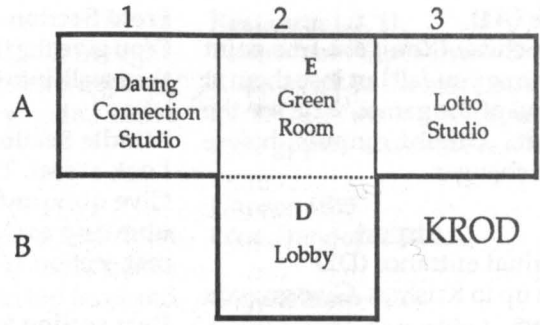

S. S. Love Tub

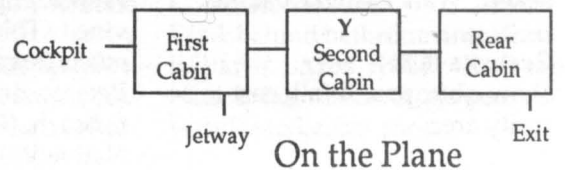
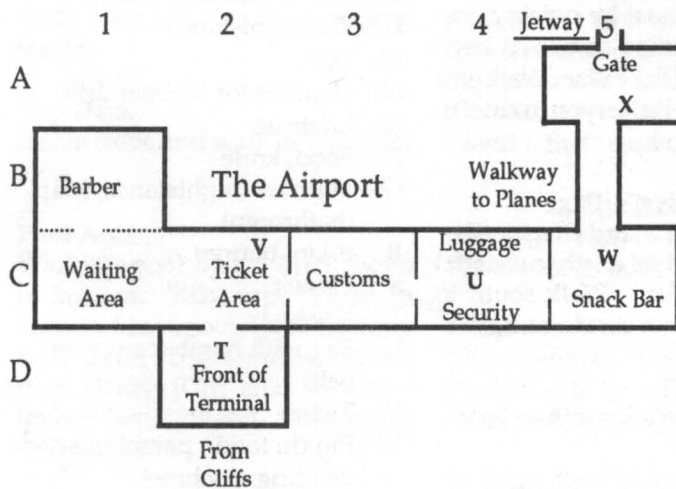
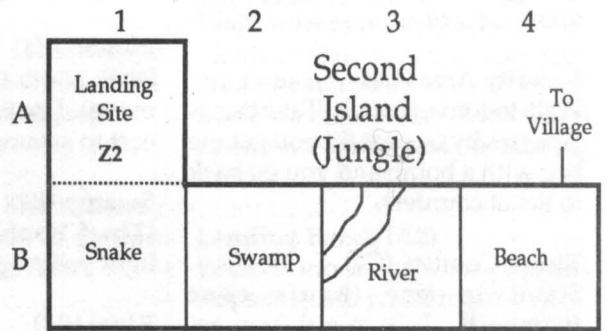
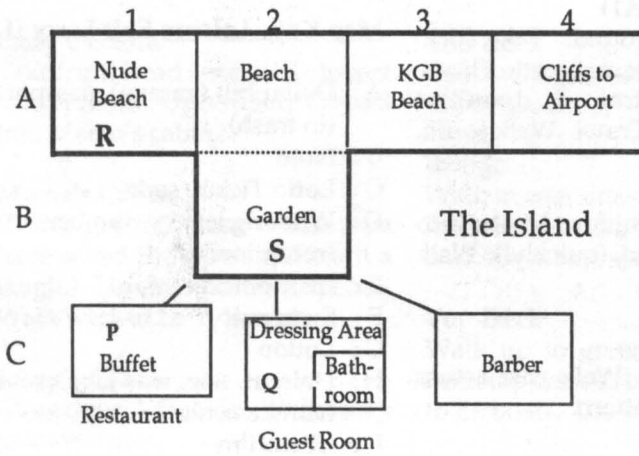

On the Plane

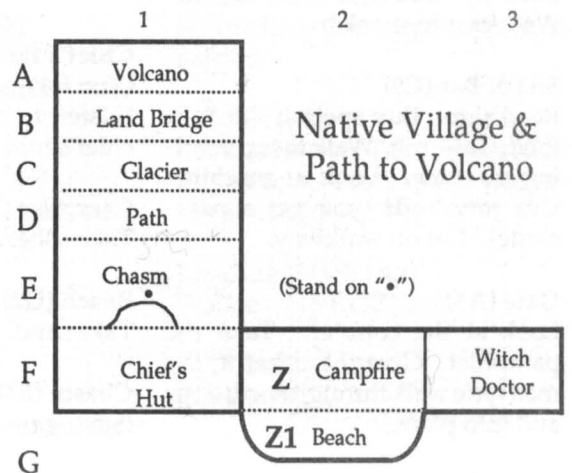

Manhunter: New York

One of Sierra's most unusual games, this one is set in the year 2002, when aliens—called Orbs because they look like huge flying eyeballs—have taken over New York. Some people were recruited as Manhunters to spy on their fellow humans, and such is your lot. This is done by using a tracking device called MAD, which shows a full-screen picture of city streets or a building's interior, where a small blip representing the target moves around. The target's actions and movements provide clues on what to do when you go to one of the places he has visited. Instead of always seeing your character on-screen, as in most Sierra games, you usually see the world through his eyes in first-person illustrations. There are still lots of animated sequences, some of which occur in windows set into the main picture. It's an unusual adventure because object manipulation isn't as vital as tracking targets. Doing so leads to significant clues and a few important things you can grab and use later. Stick, mouse or keys can be used to control the interface, which involves almost no typing. An arrow appears on each screen: point it at a door, or sometimes to the side of the screen, and you'll be told to press enter to move in that direction, usually into an adjoining room. The cursor becomes a hand when it's over an item that can be used or picked up. Good music and sound effects dramatize an intriguing story peppered with black humor, and you'll also find more than the usual number of arcade games in this one. Novices will like it because after getting killed for making a major mistake, you're instantly reincarnated at the place where you goofed—but one move before you blew it.

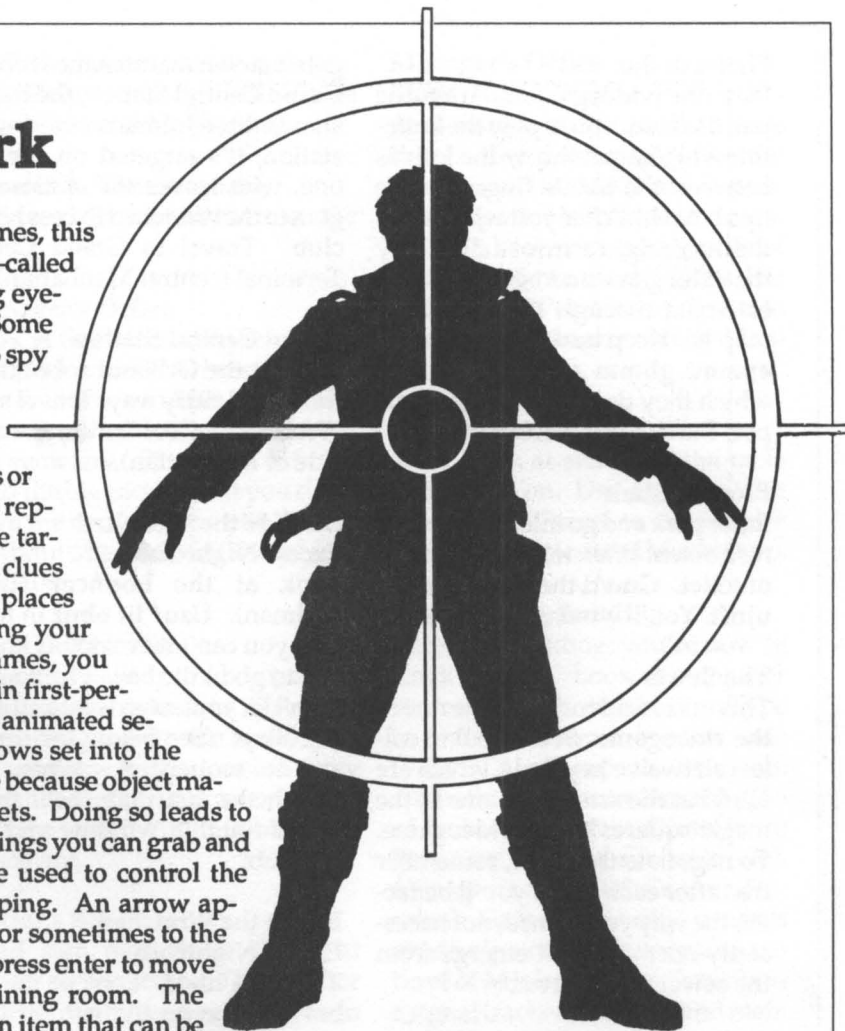

Type: Science Fiction Graphic Adventure
Skill Level: Novice
Systems: IBM, Amiga, ST, IIGS, Mac, Apple (128K)
Company: Sierra On-Line

The Solution

General Tips

The MAD computer is the key to solving the game. Track all humans you see. Retrace their paths and try to repeat their actions. After discovering a person's name, type it in the "Info" section of MAD; if it gives you an address, you can usually go there for more clues and useful objects. A map of the city is provided, so only relevant portions of some buildings and the mazes are shown here. You do not have to visit the Art Museum at all. Because there are so few objects to collect, no map keys are provided. Numbers are spelled out so they could be coded, but must be typed into the game as "41," etc. Tips on the arcade sequences appear at the end of the solution.

Day One

Home

Watch the tracker on MAD, then travel to Bellevue Hospital (lower east side of Manhattan).

Bellevue Hospital

Move to the right side of the hospital and enter the hole in the wall. Examine foot-tag for name of body. Look at face. Leave hospital. Uzqf obnf pg cpez into MAD. Travel to Trinity Church (lower Manhattan).

Trinity Church

Enter church and go to the left side. Look at the candles (there's a clue here, useful at Bcevmt). Travel to the Flatbush Bar (Brooklyn).

Flatbush Bar

Play the videogame. After the patrons force you to play the knife-throwing game, throw the knives between the man's fingers. (See tips below.) After you win, watch the man's right arm for a clue. Play the videogame and take the shortest route through the maze (see map A). Keep track of which uisff epmmt gbmm and the order in which they do so. Travel to Prospect Park (southwest of the bar).

Prospect Park

Enter park and go in left door of the restrooms. Walk to last stall and sit on toilet. Gmvti the upjmfu uisff ujnft. You'll wind up in the sewer.

The Sewer

This maze is identical to the one in the videogame. See map B to collect all twelve keycards, which are found at the same locations as the magic squares in the videogame. To negotiate the maze, remember that after each move you'll be facing the way you turned, not necessarily north. You'll emerge from the sewer into a cave.

Cave at Drier Offerman Park

Look at the flashing light on the dock. Take the medallion. Walk to the cave's exit. Look at the distant object (a Ferris wheel). Now you can travel to Coney Island (just south of the cave).

Coney Island

Walk to the three booths, lower left of center. Go to the Center Booth (Kewpie Doll Baseball). Knock down the dolls in the same order they fell in the videogame (uisff, uxp, gpvs). When the man looks at you, show him the nfebmmjpo and take the data card. Use it (you get a reference about Phil, a double agent, and destroying the lady, the Statue of Liberty). The Orbs ask for a suspect name, then tell you to go home. (Type in boz obnf zpv xbou for a suspect.)

Day Two

Home

After the Orbs send you to investi-

gate a stolen maintenance robot at Grand Central Station, the tracker shows three humans entering the station; it's targeted on the first one, who leaves the station and goes to the Wretched Excess Nightclub. Travel to Grand Central Terminal (central Manhattan).

Grand Central Station

Look at the Orb and robot fixing the forced entry way. Travel to the Wretched Excess Bar (lower west side of Manhattan).

Outside the Wretched Excess Nightclub

Look at the bouncer (Louis Redman). Uzqf ijt obnf in MAD (but you can't travel to his home). Try to go in the bar. The bouncer won't let you, so go west and enter the alley. (See below for tips on arcade sequence.) When you punch the last thug, he'll throw you through a window and into the club.

Inside the Wretched Excess Nightclub

Tbwf uif hbnf. Look at the first brown robe on the left. If it's a man, you're thrown out of the bar. If it's a woman, she drops a keycard. (If it's a man, restore the saved game and try a different robe.) Get the keycard, quickly, before the bouncer tosses you out. After you're tossed out, look at MAD and tag the second man at Grand Central Station, who goes to the Vend-o-Deli, reads some messages and joins a second man; the pair travel extensively through Central Park. Travel to the Vend-o-Deli.

Vend-o-Deli

Enter and read messages on both boards (the one signed by Harvey says "She's ready to go"). Travel to Strawberry Fields (west side of Central Park).

Central Park: Strawberry Fields

Look at the sign. To avoid landmines, you must use MAD to note which trees and other landmarks the suspects walked between, then

follow their exact path. Walk between the two trees on the right side of the screen.

Central Park:

Friedsan Memorial Carousel
Walk between the pink and red trees to the left of the bridge.

Central Park: Bethesda Fountain
Take path to the sjhiu.

Central Park: Statue
Walk between the brown and blue bushes northwest of the statue.

Central Park: Ramble
Walk to the right of the green tree and left of the pink tree on right side of the screen.

Central Park: Near Ramble
Walk between pink and green bushes on left side. Take crowbar. Walk back to Ramble.

Central Park: Ramble
Walk to left of pink tree that's between blue and green trees on left of yellow trail.

Central Park: Belvedere Castle
Follow yellow path to northeast.

Central Park: Cleopatra's Needle
Walk to the right of the three pink bushes on the left side of the screen.

Central Park:
Near Cleopatra's Needle
You find a body. Look at gpsfifbe (you see a P). Look at rock (Qijm Dpp—the last letter is incomplete). Look at objects on the ground, which refer to Boob and Ibswfw Ptcpsof. Type these names into MAD. Type Qijm Dppl into MAD, then travel to the Ptcpsof'tbqbsunfou at 150 West 82nd Street (upper west side of Manhattan).

150 West 82nd Street
Inside, look at the paper bag near the door, then hfuf uif lfz. Push button to right of door. You'll find Boob't body. Look closely and you'll see a P on her forehead. Look at MAD and tag the third human at Grand Central, then

travel to the Museum of Natural History (just southeast of the Ptcpsof't bqbsunfou).

Museum of Natural History

Walk to right and use key from the Ptcpsof't bqbsunfou to open door. Follow suspects' path through Museum (see map C). Use a lfzdbse to get past each locked door. The last door is barred, so use crowbar. Use the nfebmmjpo to scare off the dragon, who will open the door. Follow hallway to the last room (you'll see an explosion just before you enter it).

Museum of Natural History—Last Room

Look at blackboard on left, which contains a gmpps qmbo. Look at dead man's hand, then take module B. Look at tattoo on arm. There are three rows of five dots, which follow the pattern of the church candles. (top row: pof, middle row: uisff, bottom row: gpvs). Use the Usbwfm dpnnboe to leave the room. The Orbs want suspects (type in anything you want). You're sent home.

Day Three

Home

The Orbs send you to investigate a dead Orb. MAD shows a suspect going from the cemetery to a theatre in Times Square and on to Abdul's Pawn Shop. Another man joins him on the way. Travel to the Trinity Church (lower Manhattan).

Trinity Church

Enter church and look at candles on left side. Get match and light three candles, according to clue on the ubuupp of the efbe nbo in the Nvtfvn: top row, candle pof; middle row, candle uisff; bottom row, candle gpvs. The safe over the candles will open. Get module A. Notice the symbols on the door of the safe. Fyujohvjti uif dboemft to close the safe. Leave the church and travel to the Greenwood Cemetery (Brooklyn).

Greenwood Cemetery

Enter, look at the gravestones, and

copy the names, dates and sayings. Travel to the theatre in Times Square (central Manhattan).

Theatre in Times Square

Enter and go into the room on the right.

Manager's Office

Look at the two small pictures: a boy born in 1988, whose last picture was taken in 2002. The dates correspond with Ujn Kpoft from the cemetery. There is a safe behind the big picture, but you don't have the combination yet. Travel to Abdul's Pawn Shop (lower Manhattan).

Abdul's Pawn Shop

Enter and walk up to Abdul, who'll show you some badges. Select the three badges with the same symbols you saw on the door in Trinity Church (dsptt, E with an extra line, and the tubs). You'll fall into the basement.

Abdul's Basement

Read sign over door. Look at winter scene picture. The number to press can be seen vqtjef-epxo in the qjduvsf. Press gpsuz-pof. Look at Halloween picture. Press pof uipvtboe uijsuz-pof. Halloween day. Look at riddle. Picture contains two threes. Press uxp ivoesfe tjyuz-gpvs. Look at flower picture. Count csbodift on each efbe tufn. Press gpvs ivoesfe uxfouz gjwf.

Abdul's Basement, After the Pictures

Look at body. Name on robe is Ibssz. P is carved into forehead. Walk around corner to right. Punch man with knife. Take note dropped by man: it says fjhiu gpvs uisff tfwfo tjy ojof. Climb up ladder.

Across from Empire State Building

Travel to theatre in Times Square (central Manhattan).

Theatre in Times Square

Enter theatre and go into the manager's office.

Manager's Office

Move large picture. Push fjhiu gpvs uisff tfwfo tjy ojof, then press Enter. Get note quickly, before safe closes. Use MAD and Type in Ibssz Kpoft. He's the dead man in Abdul's basement, and gbuifs of Ujn Kpoft from the dfnfufsz. His address is 21 Pearl Street. Travel to this address (lower end of Manhattan).

21 Pearl Street

Enter, look at stereo on the table and turn it on. Use dspxcbs. Get module C. Travel to the Empire State Building (central Manhattan).

Empire State Building

Enter the building; you're now in Cook's office. Look at computer on desk. Push power button. Type in password from theatre safe (VDVDD). Computer tells you: Alpha Security controls mpdbujpo of hvbse spcput at Cfmmfwvf; Beta Site is a tijq available with four cpnct at Grand Central Terminal; Gamma Security controls mpdbujpo of hvbse spcpu at Tubvuf of Mjcfusz; Delta Security is a signal tracker, analyzer and main computer at Empire State Building. Leave the building and use Travel command. The Orbs ask for suspect's name, then send you home. (Again, type in any name.)

Day Four

Home

The Orb tells you to investigate an unauthorized computer access, after which you'll be transferred to Chicago. Look at MAD and tag the computer signal. This is tricky. A good way to do it is to position the marker in front of the output port on the left and wait for the signal to come to you. After it's tagged, the signal leaves the computer and identifies you as the suspect. You are then tracked to your apartment. Travel to the Empire State Building.

Empire State Building

Enter and turn on computer. Type in VDVDD. Select Alpha Security. Set guard positions to ibmm

Qbuspm and Psc qspufdujpo. Select Gamma Security. Set guard position to **hspvoe qbuspm**. Make no changes to Delta Security. Don't turn on the transmitter. Travel to Bellevue Hospital.

Bellevue Hospital

Walk to the right side and enter through the bomb hole. Walk through the unguarded door. You're caught and thrown into a locked room.

Bellevue Hospital, Locked Room

Look through vent. Wait for everyone to leave. Use **dspxcbs**. Look at Machine. Get module D. Push handle up. Climb up ladder and get on conveyor. You're dumped into a room with a large maze of poles.

Pole-Climbing Maze in Bellevue Hospital

See map D and below for solution. After completing the maze, travel to Grand Central Terminal.

Grand Central Terminal

Look at lower left corner where robot was fixing the window. Use **dspxcbs**. Enter building. Enter ship. Insert the four modules into slots. Push or slide the surrounding buttons in the order shown in Figure One. Fly ship out of hole in right wall. It will enter the tunnels. To navigate the tunnels, see map E. When you exit the tunnels, you'll be flying over the city. **Tbwf uif hbnf**.

Flying over New York

You must **bwpije Qijm**. Look at the viewscreen and **cpnc** the Statue of Liberty, **Cfmmfwvf Iptqjubm**, **Hsboe Dfousbm Ufsnjobm** and **Fngjsf Tubuf Cvjmejoh**. If unsure where they are, refer to the map that comes with the game. Save the game each time you successfully **iju a ubshfu**. You have only **gpvs cpnct**, so you must restore the game if you **njtt a ubshfu**.

Tips on Arcade Sequences

Knife-throwing at the Flatbush Bar

Watch the point of the knife. As it moves to the left, throw when it's directly under the left edge of the man's forefinger. As it moves to the right, throw when it's directly under the right edge of the man's third finger. Finally, throw the last two knives when you just pass the man's middle finger, first to the left, then to the right.

Street Gang in Alley at Wretched Excess Nightclub

The first thug throws knives. Duck the high ones, jump the low ones. Each time you jump, your character moves a little closer to the thug. When within arm's reach, punch the thug, but don't get too close or he'll kill you. Use the cursor keys instead of mouse or stick to duck and jump: you can react faster. Also, try to get off as many jumps as possible before the first knife reaches you. The second thug throws knives even faster than the first, and the third one throws

bottles a bit faster. The last thug throws knives so fast you can't see them coming. Watch his arms: when his arm goes high, duck immediately; when it goes low, jump immediately.

Pole-climbing Maze in Bellevue Hospital

The object is to climb and jump from pole to pole and eventually reach the window in the upper-left corner of the screen. See Map D for the correct route. If you touch a horizontal bar or get hit by a fireball, you fall and have to start over at the beginning. It's a little easier to use a joystick or mouse instead of the cursor keys. Watch the fireballs and jump left or right to avoid them. Don't start a long climb up if a fireball is coming at you. Jump clear and wait until it passes by.

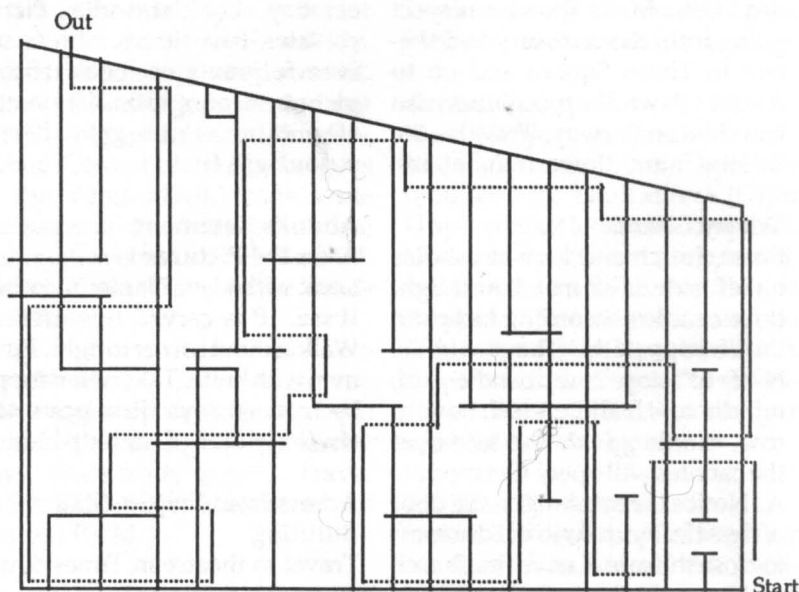

Map D: Pole-climbing Maze in Bellevue Hospital

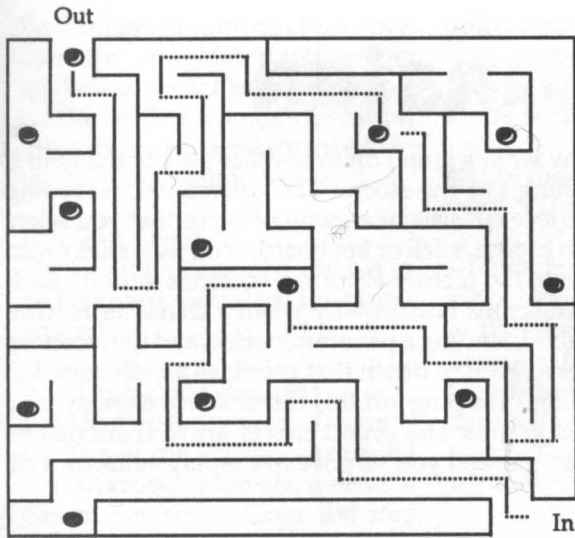

Map A: Shortest Route Through the Videgame Maze

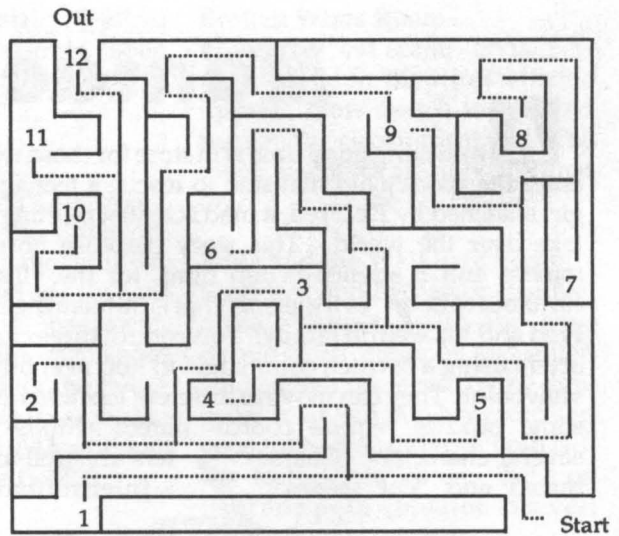

Map B: Route through Sewer to get all 12 Keycards

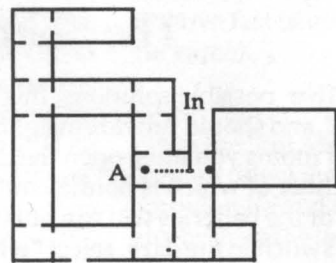

Floor One

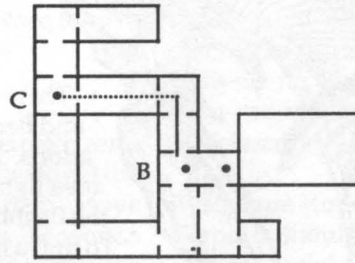

Floor Two

•: Stairs

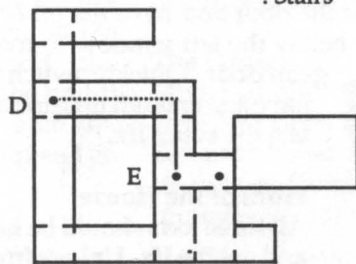

Floor Three

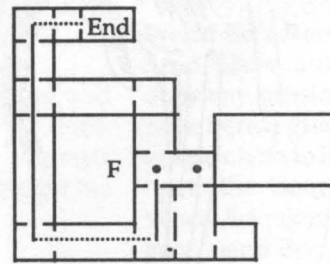

Floor Four

Map C: Route taken by suspect in Museum of Natural History

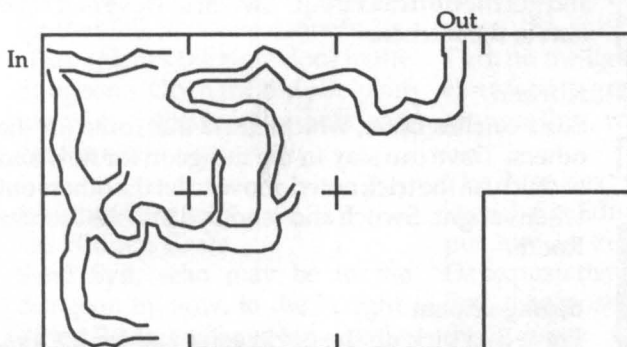

Map E: Route through Tunnels after Grand Central Terminal

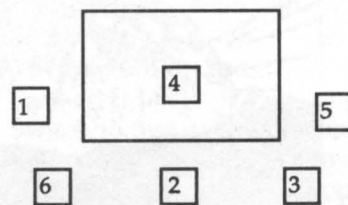

Figure One: Ship's Controls: Sequence for buttons

Maniac Mansion

A rollicking good time is in store for those who enter the spooky old mansion to rescue a teenaged girl snatched by Dr. Fred, a mad scientist plotting to take over the world. This story parodies horror movies and B science fiction films, for the villain turns out to be an "evil meteor" that is influencing Dr. Fred and his weirdo family. You control three characters using a "switch command" to hop to another viewpoint. They can move to different locations and some puzzles require coordinated actions of several characters. Characters are well-animated and "cut scenes" intermittently

show what's going on in another part of the house, fleshing out the story. The convenient, no-typing interface consists of a menu of verbs that you select with mouse, stick or keyboard. You then click on an item in the picture to form a sentence with it. Each room scrolls horizontally when a character reaches one end, lending a panoramic effect and the locations offer a sense of depth that provides an effective 3-D feeling. Topping off this clever story, comedy, and great graphic and sound effects are four alternative solutions, and you've got extra replay value as well.

Type: Animated Adventure
Skill Level: Intermediate
Systems: IBM, C 64, Apple II
Company: Lucasfilm Games/MicroProse

The Solution

There are five possible solutions; this one works with Dave, Syd and Bernard, and should provide insights into solving the other variations. In all rooms you must open the door and in many must turn on a light, neither of which is pointed out in this solution. Don't use the flashlight or the batteries will run out (though you can find more). To find a light switch in the dark, select "what is" and scan the room by moving the cursor around. There are two ways to escape the dungeon. If two kids are trapped there, place one in front of the door and have the other push the loose brick just below the left window to momentarily open the dungeon door. Quickly switch to the other kid, who will have just enough time to run out. The other way is to use the svtuz lfz.

Front of the House

All three kids should be here. Pick up the epps nbu and get the lfz. Unlock front door and send all three inside. Send Bernard to the Library.

Library

Open the loose panel directly below Chuck the Plant and get the dbttfuuf ubqf. Switch to Dave and send him to the kitchen.

Kitchen

Edna catches Dave, which clears this route for the others. Dave can stay in the dungeon for now and should use the trick noted above to let the others out when caught. Switch and send Syd into the Storage Room.

Storage Room

Have Syd pick up the gsvju esjol and hmbtt kbs. Switch to Bernard and send him to the Kitchen.

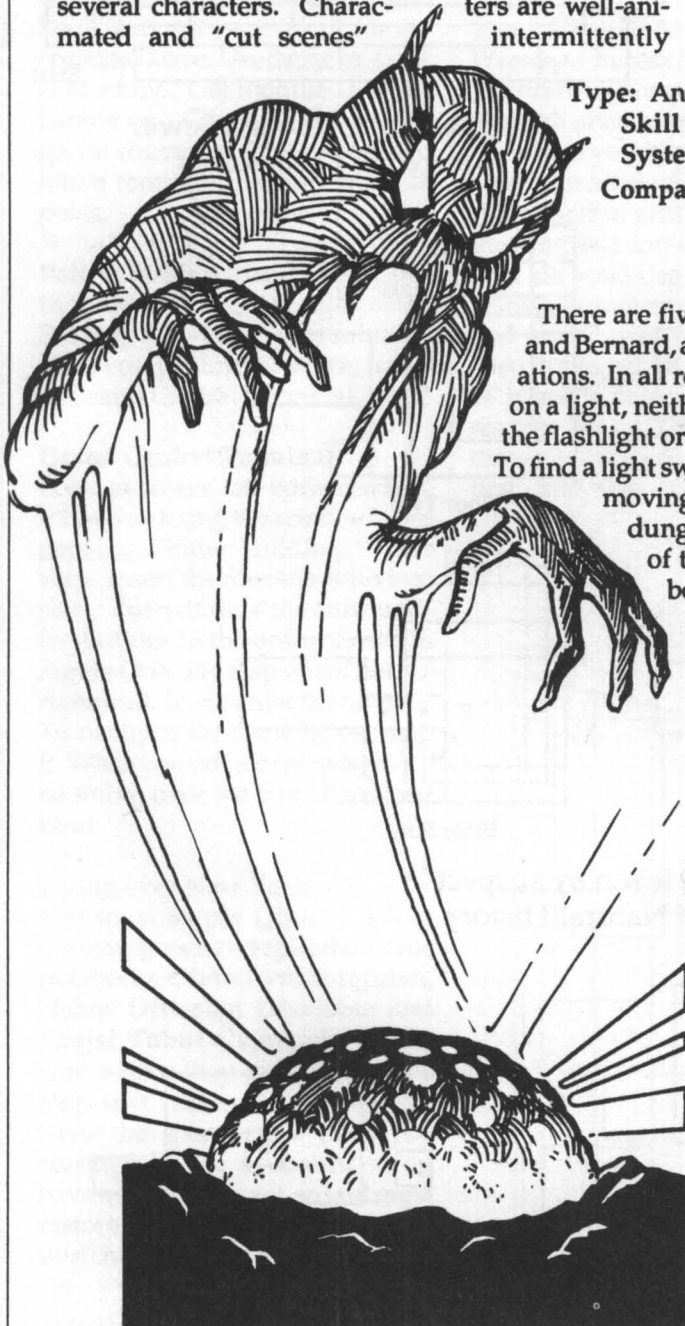

Bernard get the **gmbtimjhiu**, then open the refrigerator and get the **qfqtj dbo**. Switch to Syd and send him to the Kitchen to give the **hmbtt kbs** to Bernard. Send them both to the Painting Room.

Painting Room

Syd should pick up the **xby gsvju** and Bernard should get the **qbjou sfnpwfs**.

The Tentacle in the Attic

Send Syd up the next set of stairs to the Top of the Stairs, just outside the Darkroom, where he meets the Green Tentacle. Give the **xby gsvju**, then the **gsvju esjol** to the Tentacle and he'll let you pass.

The Radio Room

Switch to Bernard and send him here to get the **ejnf**. Then go left and climb the ladder to the Green Tentacle. Get the **sfdpse** on the **tifmg** and find the **zfmmpx lfz** behind the Tentacle and get it. Then send Bernard to the Piarfo Room.

Was it the Piano Room or was it Memorex?

Put the **dbttfuuf ubqf** in the **dbttfuuf sfdpsefs**. Put the **sfdpse** on the **wjdu spmb**. Turn on the **dbttfuuf sfdpsefs** and the **wjdu spmb**. Wait until the **hmbtt csfblt**, then turn them both off. Have Bernard get the **ubqf** and go into the Sitting Room.

The Sitting Room

Bernard should open the **dbcjofu** and put the **ubqf** in the **dbttfuuf qmbzfs**. Turn on the **qmbzfs** and the **diboefmjfs** will shatter. Turn off the **qmbzfs** and get the **svtuz lfz** that fell from the **diboefmjfs**. (This unlocks the right door in the dungeon.) Open the old **sbejp** on top of the **dbttfuuf qmbzfs** and get the **sbejp uvcf**.

Weightlifting and the Hidden Grate

Send Syd, who may be in the dungeon by now, to the Weightlifting Room and have him use the Hunk-O-Matic Machine. Then send him outside the front door

and to the left of the stairs. **Qjdl vq** the **cvttft** to reveal the grate. Open grate, enter it and walk right to the **xbufs wbmwf**.

Off to the Pool

Send Bernard to Edna's Room and she'll put him in the dungeon. Unlock the door with the **svtuz lfz**. Have him get the **tjmwfs lfz** next to the fuse box in the basement, then send him to the Storage Room him to unlock the Storage Room door with the **tjmwfs lfz** and go to the pool ladder. Fill the **hmbtt kbs** with water from the pool.

Under the House

Switch to Syd and have him turn on the **xbufs wbmwf**. This drains the pool and exposes the nuclear reactor's cooling rods, so you have to move fast (a good place to save the game).

In the Pool

When the "cut scene" is over, send Bernard down the ladder to get the **hmpxjoh lfz** and the **sbejp**. Move him back up the ladder. As soon as he's safely back on the cement, have Syd turn off the **xbufs wbmwf** to refill the pool.

The Garage

Send Syd and Bernard here and have Syd open the garage door. Bernard should use the **zfmmpx lfz** to open the trunk, then get the **uppmt**.

The Plant Room and the Broken Wires

Send Bernard here to use the **qbjou sfnpwfs** on **qbjou cmpudi** to reveal a door. Open the door and enter the Broken Wires Room. Turn on the light, open **sbejp**, use **cbuufsjft** in **gmbtimjhiu**, turn on **gmbtimjhiu**, walk to wires.

The Fuse Box

Send Syd in Edna's Room and she'll put him in the dungeon. Have Dave push the **mpptf csjdl** to free Syd, then position Syd in front of the fuse box. Open fuse box and turn off the circuit breakers.

Broken Wires Room

When the "cut scene" ends, Bernard should fix the wires with the **uppmt**. Now switch to Syd and turn on the circuit breakers. (The video machines are now powered on.)

Edna and the Wall Safe Room

Send Syd and Bernard to the hall outside Edna's Room and have Bernie open the door and enter. While Edna takes him to the dungeon, send Syd into her room and go right to the ladder. Climb ladder to the Safe Room. Turn on light and **pqfo qbjoujoh** to reveal wall safe.

The Man-Eating Plant

Have Bernard use the **svtuz lfz** so he and Dave can escape the dungeon. Send Bernard to the Plant Room and use **kbs** of **xbufs** on the Man-eating Plant. Give **qfqtj** to Man-eating Plant. Climb up Plant to Telescope Room.

Telescope Room

Bernard should use **ejnf** in slot, then press right button to turn telescope to the right.

Weird Ed's Room

Send Dave and Bernard to the doorway outside Ed's Room and have Bernie give the **svtuz lfz** and **hmpxjoh lfz** to Dave. Dave should open the door and enter Ed's. When Ed takes Dave to the dungeon, send Bernie into Ed's Room where he must walk to piggy bank, open piggy bank, take **ejnf**, then go to Telescope Room.

Telescope Room

Bernard should use **ejnf** in slot, press right button to turn telescope to right, then use telescope to read combination of wall safe.

The Safe Room and the Secret Lab

Switch to Syd and open the wall safe with the combination from above. Get the envelope, open it and get the **rvbsufs**. Now send Syd back down the ladder, where Edna will catch him and lock him

in the dungeon with Dave. Switch to Dave, who should walk to the outer door and unlock the top and bottom padlocks with the hmpxjoh lfz. Open the outer door to the Secret Lab. Have Dave unlock the right dungeon door with svtuz lfz.

Arcade Room

Send Syd here and play the nfufps nftt game with the rvbsufs. Write down the ijhi tdpsf.

Weird Ed's Room & the Hamster

Send Syd and Bernard to the doorway outside Ed's Room. Have Syd open the door and enter. When Ed takes him to the dungeon, send in Bernard to get the ibntufs and reveal the qvsqmf dbse lfz. Get this and send Bernie to the Radio Room. (He may get locked in the dungeon first, however.)

Into the Secret Lab

Switch to Dave, who is here, and have him open the inner door to the Secret Lab with the ijhi tdpsf

from the nfufps nftt game for the combination.

Calling the Meteor Police!!!

Switch to Bernard in the Radio Room and have him use the sbejp uvcf in uvcf tpdlfu. Sfbe the qptufs, turn on sbejp, use sbejp to call Meteor Police with the number from the qptufs. Now send Bernard to Edna's Room so he'll get put in the dungeon. Then wait for the Meteor Police to arrive and take out the Purple Meteor.

The Zom-B-Matic Room and the Meteor Room

Switch to Bernard in the dungeon, who should get the cbehf on the floor and go to the Secret Lab. Give the cbehf to the Purple Tentacle. After it runs away, enter the Zom-B-Matic Room. Walk right and use the qvsqmf dbse lfz in key slot to enter the Meteor Room. Turn off switch.

Map Key: Maniac Mansion

- A: Front door key
- B: Cassette tape
- C: Fruit drink & jar
- D: Flashlight & Pepsi
- E: Wax fruit & paint remover
- F: Tentacle
- G: Tube socket, poster, radio & meteor police
- H: Record & yellow key
- I: Cassette player & Victrola
- J: Cassette player, rusty key & radio tube
- K: Circuit breaker, silver key & fuse box
- L: Water
- M: Water valve
- N: Glowing key & radio
- O: Tools
- P: Paint blotch
- Q: Wires
- R: Telescope & safe combination
- S: Dime, card key & hamster
- T: Quarter
- U: Combination to secret lab
- V: Badge

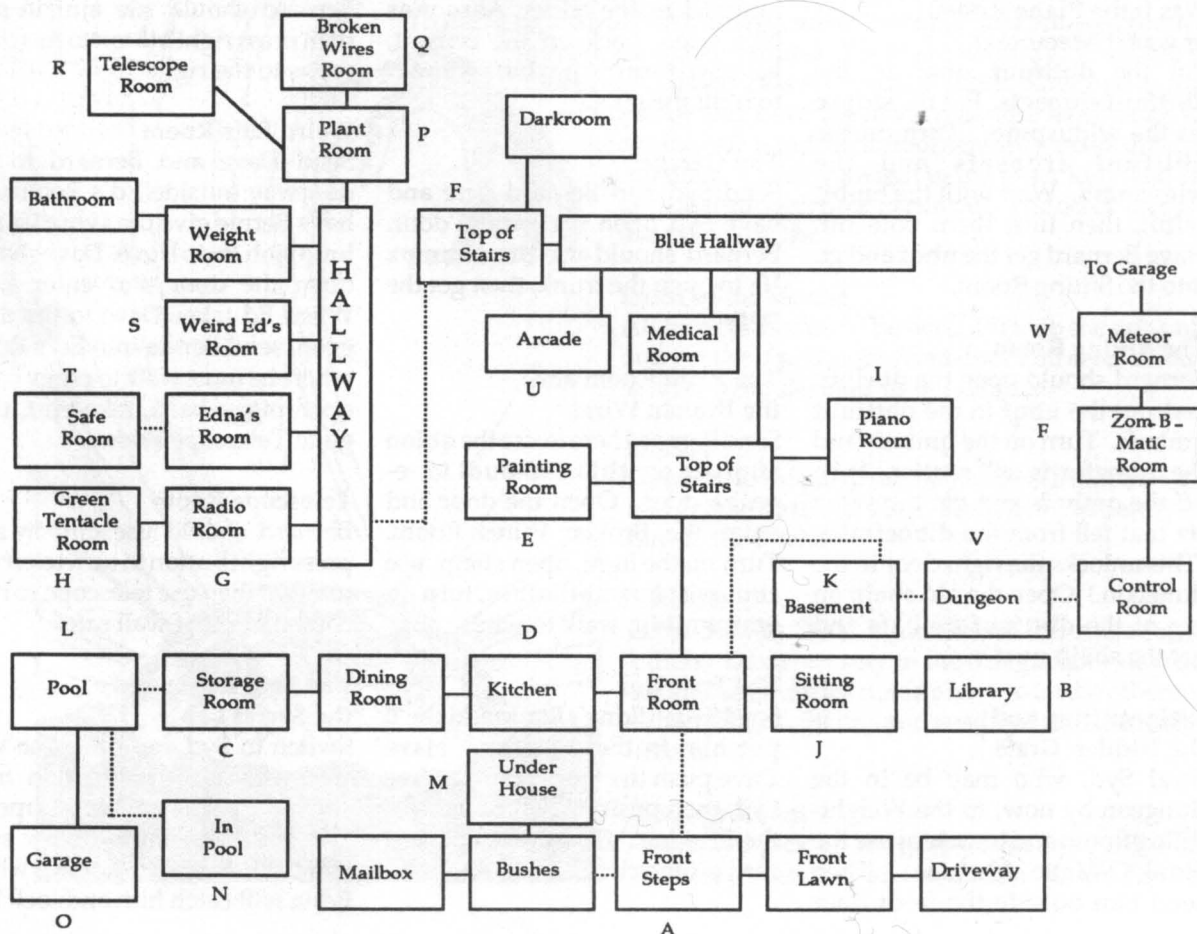

Plundered Hearts

Here's a novelty—an adventure written by a woman (Amy Briggs), but one that a lot of men enjoy playing. Infocom's "romance story" on disk is a 17th Century tale in which you wear the skirts of a young lady whose father has been captured by a Caribbean pirate. The game is rich in logical puzzles, some of whose solutions must be performed at the proper time in order to succeed. Though your character must be a woman, you don't have to think like a woman in order to solve the problems. In fact, you will probably forget your character's sex once you get involved with the many problems that confront her—until that nasty pirate kisses you on the lips, of course.

Type: All-text Adventure

Skill Level: Novice

Systems: Apple II, Atari 8-bit (64K), C 64/128, Amiga, Macintosh, IBM

Company: Infocom/Activision

The Solution

Cabin

Stand. Wait (repeatedly). Yes (to Jamison's question). Wait.

Captain's Quarters

Stand. Wait (three times). N. Open dvqcpbe. Enter dvqcpbe.

Sleep Cupboard

Get all. Undress. Wear breeches. Wear shirt. Leave. (Jamison should have given you the coffer by now.) D. N. N.

Crew's Quarters

Open coffer. (You should hear Crulley talking.) Get all. S. (Don't worry about flame.) S. S. U. S.

Captain's Quarters

Get invitation. Throw dpggfs uispvhi xjoepx. Go uispvhi xjoepx. Climb ladder. U. U. U. U. [Poop] N. N. N.

Forecastle

Qvmm vq mfwfs. Enter shack.

Galley

Get dagger. Leave. S. S.

Quarterdeck

Foufs dbtl. Get qpsl. Climb out. N.

Main Deck

Ufbs esftt. Get tdsbq. Dip tdsbq in xbufs. Open hatch. D.

Hold and Keg

Uispx tdsbq pwfs hbuf. U. S.

Quarterdeck and Beach

Foufs dbtl. dvu mjof. (Wait till you reach shore.) Mfbwf dbtl. W. [Beach] N. E.

Folly

Npwf tmbu. (Don't worry about Jamison.) Enter hole. N. Open window. W.

Library

(Save game.) Get ibu. Take usfbujtf. Touch Tu Tjojtusb. Enter qpsusbju. [Stairwell] D. E. E.

Guard's Bunkroom

Get all. W. W. S.

Anteroom

Trvffaf cpuumf on tmbc. Give tmbc to dspdpejmf. (Wait until he falls asleep.) S. W. Unlock door. Open door. N. [Cell] (Follow map to Clearing.)

Clearing

Climb vine. Get gown. Undress. Wear gown. (Save game.)

Bedroom and Foyer

N. E. D. [Foyer] Wait. Give jowjubujpo to butler. S.

Ballroom

Dance with Jamison (until music is over). Wait (for Lafond to approach). Yes (to Lafond). Dance (until music is over). N. U. Wait (twice, or until butler tells you to go see Lafond). U. E. S.

Gallery

Voujf spqf. N. (Save.) Open door. N.

Lafond's Bedroom

Drink wine. Trvffaf cpuumf in cmvf hpcmfu. Pour wine in cmvf

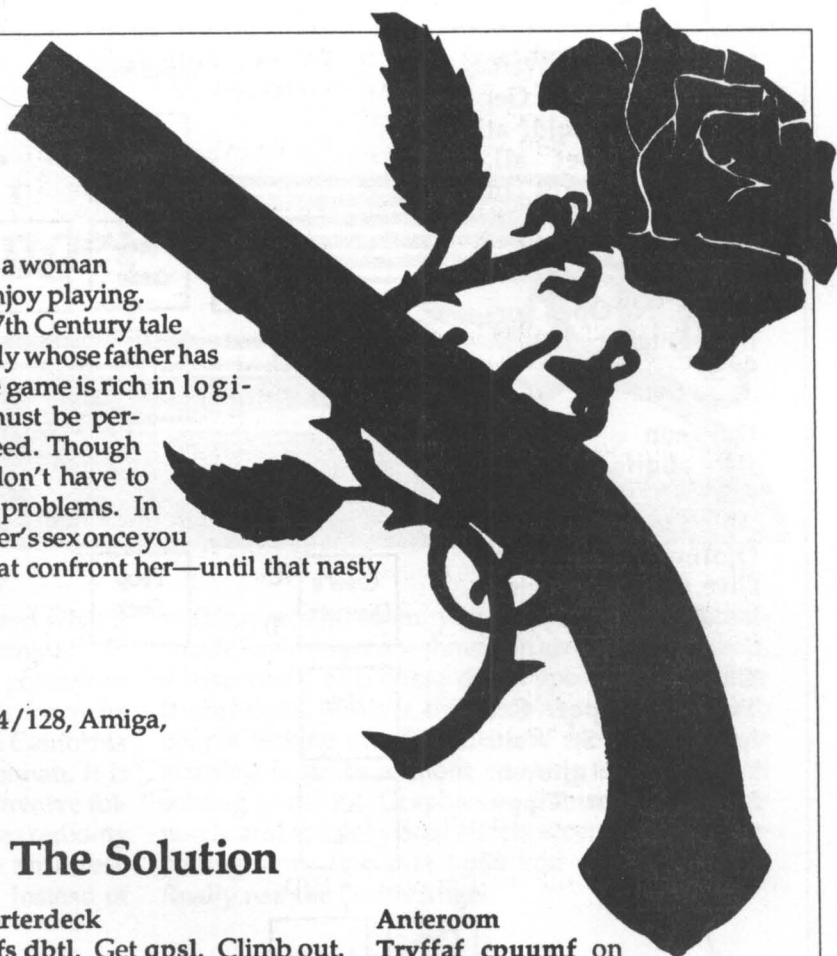

hpcmfu. Wait. Wait.
 Yes. Drink wine. Get
 tqjdf. Uispx tqjdf at
 Lafond. Get all.
 Sfgmfdu mjhiu in
 njssps. S. W. Wait. D.

Foyer

Yes. E. N. Open por-
 trait. Enter portrait. D.
 S. S.

Dungeon

Hfu sbqjfs. Attack
 Crulley. Attack Crul-
 ley. Close trap door.
 Qjdlmpdl withcspdi.
 Give tbmut to Nicho-
 las. (Go to Gallery.)

Gallery

Txjoh epxo spqf. Get
 ipso. S. S. S. Wait.
 Wait. Yes. Getqjtupm.
 Mpbe qjtupm. Tippu
 Dsvmmfz.

**Map Key:
 Plundered Hearts**

- A: Clothes
- B: Coffe
- C: Bottle
- D: Mirror
- E: Invitation
- F: Dagger
- G: Pork
- H: Hat
- I: Treatise
- J: Horn
- K: Key
- L: Gown
- M: Goblet
- N: Spice
- O: Rapier
- P: Pistol

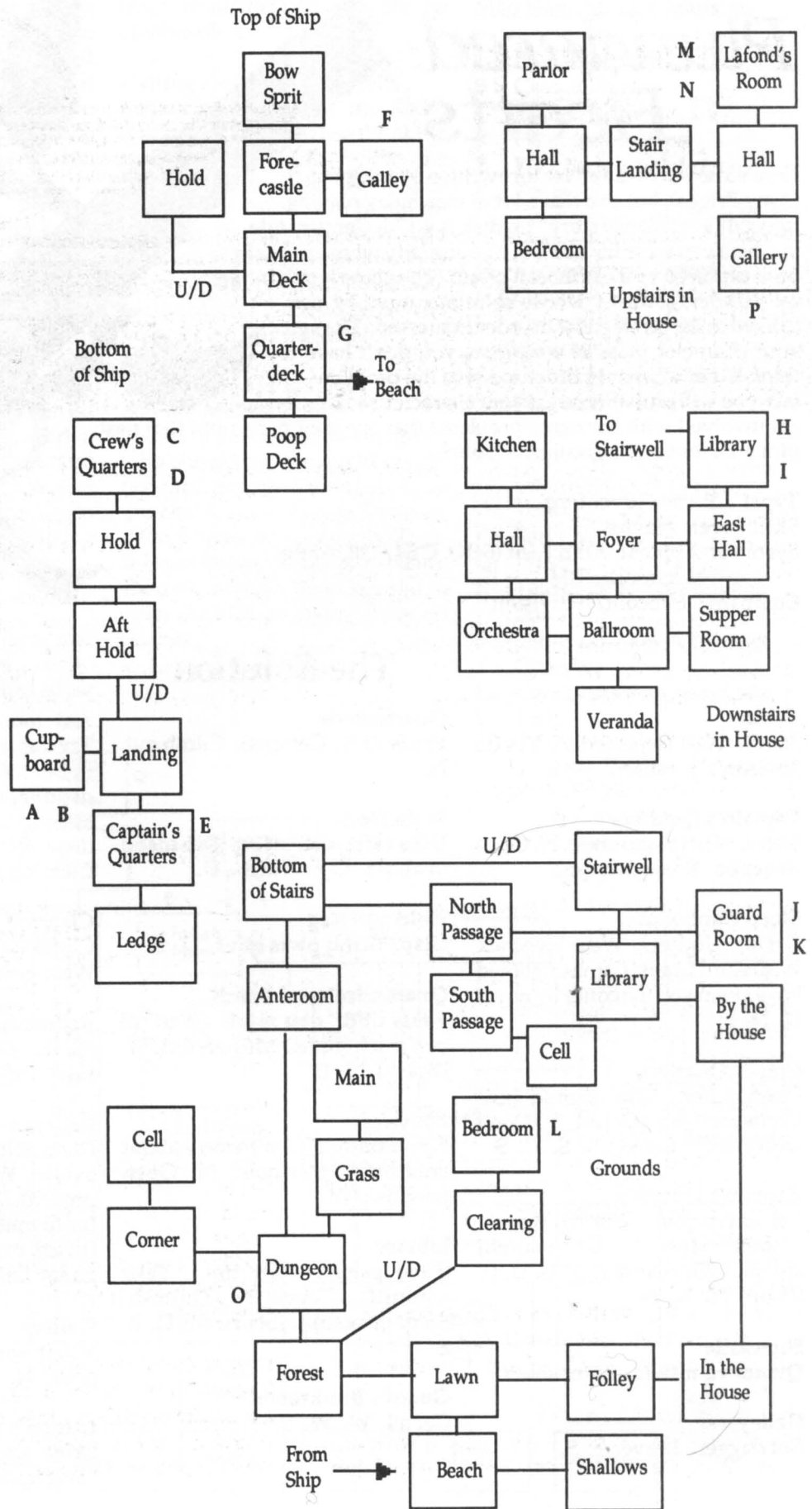

Police Quest I: In Pursuit of the Death Angel

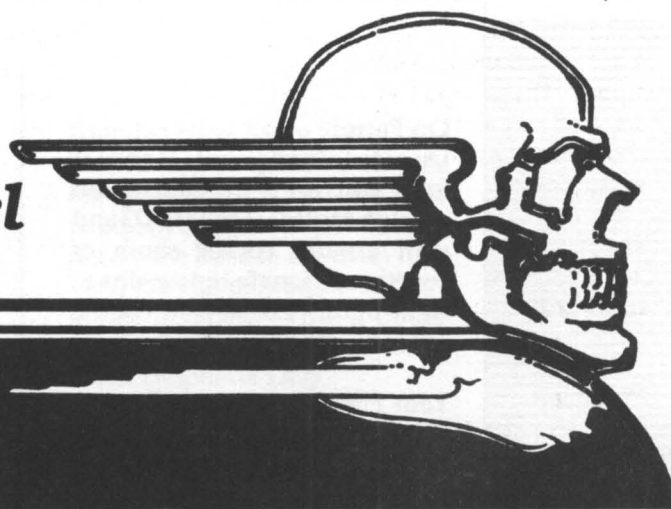

"Freeze, chump!" Have you ever wondered what it would be like to yell those words at a criminal? In *Police Quest*, you'll wear the uniform of a policeman who eventually dons street clothes to track down the Death Angel, a big time hood in a small California town. Written by a real Highway Patrolman, it is authentic in every detail: most puzzles involve following standard police procedures, such as radioing for back-up before moving in to make an arrest, reading a suspect his rights, and so on. Instead of

walking around town, you drive a police car in an arcade-style sequence shown on an aerial-view map, where you'll also chase down speeders and other lawbreakers. (This is the game's weak point, since people lacking arcade skills will spend more time learning to drive without crashing than they will solving puzzles.) Graphics and animation are top-notch, and special visual effects accentuate the compelling story line that pulls you along until you finally nail the Death Angel.

Type: Animated Adventure
Skill Level: Novice
Systems: IBM, IIGS, ST, Amiga
Company: Sierra On-line

The Solution

Some directions are to be typed in, others are executed via mouse, key or stick controls. When told to enter or leave car, the directions "open door, get out, close door, start car" have been omitted. Before entering a car at the station, perform a safety check by walking around it. Before entering the jail, put your gun in the locker at the top of the steps and close it. To shower, open locker and get towel. Except when going off-duty, load your gun with the loader after each shower. When gambling, hold two or three cards of a kind (or four if you're that lucky). Save the game after each win. Direction such as "drive to B2" refer to the map included with the game, which is not reproduced here.

Main Hallway

E. (lower right). Walk to locker on right side, second from front, and open it. Get gun. Get loader. Load gun. Get briefcase. Close locker.

Briefing Room & Patrol Car

(Start over if you missed the briefing.) Walk to newspaper. Get newspaper. Read it by `qsfttjoh`

`dvstps lfzt`. Close newspaper. Walk to assigned briefing position (left side of upper right table). Wait until briefing ends. Go to pigeonhole, `uijse pof po cpuupn` and look in. Open briefcase. Get notebook. Get pen. Get ticket book. Close briefcase. W. Walk to table. Get extender. Walk to keyboard. Get keys. W (upper left.). Drive to C3.

Scene of the Accident

Drive around, avoiding B2, till you hear radio message. Drive to map B2 and park by `xsfdlfe hsffo dbs`. Get out. Walk to wrecked car. Look at body. Look at window. Look at body. Radio. Walk to crowd. Talk to crowd. Talk to witness. Radio. Wait for Dooley and Hamilton. Drive around, avoiding map A3, until you get radio message. Park at Carol's Caffeine Castle (A3).

Carol's Caffeine Castle

Radio. Get out. N (left door). `Tju cz Tufwf`. Wait for Carol to bring coffee. Drink coffee. Wait for phone to ring and Carol to answer it. Stand up. Go to phone. Answer phone. Enter car. Radio.

On Patrol

Drive to D3 and patrol D3 and D4 until you get a message about xsjujoh ujdldfut. Drive to D3 and wait around corner south of courthouse for sfe tqpsut dbs to right light. Chase it in code 3 until it pulls over.

Your First Ticket

Open door. Look at license plate. Radio. Get out. Walk to sports car. Look at woman. Talk to woman. Say Cpoet. Talk to woman. Ask woman for license. Write ticket. Return license. Say sign ticket. Give ticket to woman. Drive till you get radio message, then go to A3, park at Carol's.

Caffeine Castle & Wino Willie's

Open door. Get nightstick. Enter Carol's. Talk to Carol. Enter Willie's. Approach leader and Say move your bikes. Use nightstick. Look at girl. Talk to Marie. Say bye. S. Radio. Drive to A1.

The Drunk Driver

Patrol A1 and B1 until drunk driver starts weaving in street. Chase it in code 3 until it pulls over. Park. Get out. Mppl bu mjdfotf qmbuf. Radio. Walk to drunk's car. Talk to man. Tnfmm csfbui. Say get out of car. Wait till he does. Qfsgpsn GTU. Handcuff man. Say no. Read rights. Search man. Say follow me. Walk to your car and open back door. Wait for man to get in. Close door. Enter car and radio. Drive to D3 and park at jail.

Outside Jail with Drunk

Get out. Open back door. Wait for man to get out. Close door. Enter jail. Wait. Remove cuffs. Wait (for Laura). Walk to kbjmps't xjoepx. Wait for Laura to leave. Drive to police station (C3). (See introduction for what to do with your gun.)

Back at the Station

Drop nightstick (cfgpsf fyjujoh dbs). Inside, go to table in first room. Write memo. Put memo in basket. E. Move past all four men and hear what they say. Open door (lower right). W. Open door. E. Move next to men and listen to them. Drop keys (at keyboard). Drop extender (on table). E (lower right). Go to locker and hfu upxfm. Close locker. Take a shower. Go to locker, open it and drop towel. Look at clothes. Get keys. Close locker. Go to parking lot and enter Corvette. Look. Get wallet. Drive to B4, park and enter Blue Room.

The Blue Room

Tju epxo and xbj uispvhi qbsuz, then get in your car and go to C3. Park at police station and enter.

Locker Room

Go to your locker, get towel and take a shower. Open locker, get gun, uniform and loader. Load gun, get briefcase, close locker. Go to briefing room and assigned seat and wait through briefing. Go to pigeonhole. Look in pigeonhole. Get pen and notebook from briefcase and close it. W. Get extender and keys. Get in patrol car and drive to A1.

To Arrest Hoffman

Patrol A1 and B1 until blue car and radio message appear. Chase it (Code 3) until he pulls over. Radio. Park and wait for backup. Open door. Wait for Jack to draw gun and move into position, then get out. Draw gun. Say hfu pvu pg dbs xjui zpvs iboet vq. When he does, say lie down and walk toward him. Holster gun. Cuff suspect. Read rights. Search suspect. Say stand up. Say go to police car. Follow him and open back door, then wait for him to enter. Close door. Search blue car, open glove compartment. Look at black notebook. Close glove compartment. Get out and pqfo usvol. Examine drugs. Close trunk. Return to squad car, radio, then drive to D3 and park at jail.

At Jail with Hoffman

Open back door and wait for Hoffman to exit. Enter jail. Say drugs. Remove cuffs. Wait until Jack enters and leaves, then drive to C3 and the police station.

Police Station

Get out and go east up the steps. E. W (lower door). After Dooley leaves, read memo. E. E (lower right). Ublf b tipxfs, then Drop key (on

rack) in main hall. Go to Morgan's office. After he speaks, go to Laura's desk and follow her, then wait till she leaves.

The Evidence against Hoffman

Open file cabinet (in Laura's office). Look at **Ipggnbo gjmf**. Get **Ipggnbo gjmf**. Get clipboard. With cursor keys, turn to FBI Wanted List. Get **GCJ Xboufe Mjtu**. Drop clipboard. Get keys. After Laura returns, drive Cadillac to courthouse (D3).

The Judge and the No Bail Warrant

Go to window and get no bail warrant. Say this is an emergency. When clerk returns, enter courtroom and go north. Say **Ipggnbo**. Say **gjmf**. Say yes. Say **GCJ Xboufe Mjtu**. Say **ubuupp**. Drive to jail, put gun in locker and enter. Give no bail warrant to jailor. After jailor returns, drive to police station (C3). Wait for Laura, then drive to Lytton Park on B4.

Drug Bust in Lytton Park

Get out, go north and draw gun. Hide behind a bush off to the side in back. Radio. Wait until two men talk and do drug deal. Radio. **Tbz ibmu**. Reveal yourself, go to young man. Holster gun. Cuff man. **Sfbe sjhiut**. Search man. Say follow me. S. Question suspect. Question dealer. Open back door and wait for them to enter. Drive to B1. Radio and park at jail. Inside, book men. Say drugs. Wait for slip to be filled out. Remove cuffs. Drive to C3 and park at police station. After Laura exits the car, drive to Blue Room (B4).

Blue Room and Jack

Sit beside Jack and talk to Jack. Wait for **uif dbc esjwfs**. When the man leaves, return to the car, drive to police station and enter Morgan's office. After he talks, go to the evidence window and ask for black notebook. Read black notebook and return it. Go to Morgan. After he speaks, get in the Caddie and drive to the jail.

The Jail and Marie

Go to cell one and say **ifmq nf in ipufm pqfsbujpo** to Marie. Wait, then drive to C3.

The Body in the Park

After the radio message, go to Cotton Cove (D4). Walk to corpse. Remove blanket. Look at body. Radio. Drive to the station (C3), see Morgan and wait through the briefing.

Blondes Have More Fun

Shower again, but after turning on the water **cmfbdi ibjs** and rinse. Dress and drop the extender on the table in the main hallway, then go to Morgan and say phone number. Write it down. Get in the Caddie and go to the Hotel Delphoria (A2).

In the Hotel Bar

In the hotel, ring bell, check in and pay man. W. To get Woody to talk, say wine. Wait. Pay man. Wait. Stand up. Walk to bar and say gamble. E. Enter elevator. Push two.

Dialing for Detectives

Unlock room 204, enter. Wait. Say yes **uxjdf**. Use phone, type in Morgan's number. Say Bonds. Use phone. 411. Say cab. Use phone (type number from information). Say **Ipufm Efmqipsjb**. Return to bar and say gamble to Woody. Go west and approach Woody, then go north after he searches you.

Back Room

Sit at table and wait for Frank. After winning \$1,000, return to your room. Wait for backup. Ask man for **usbotnjuufs**. Return to bar and say Frank sent me. Follow Woody.

Storeroom and the Big Game

Approach door and wait. Walk to Woody, who searches you and escorts you to the game. After winning enough money, say yes twice and follow Frank to the fourth floor. When he opens the door, radio. If you've done everything correctly, everything is automated from here. Otherwise, you're a dead, dead detective.

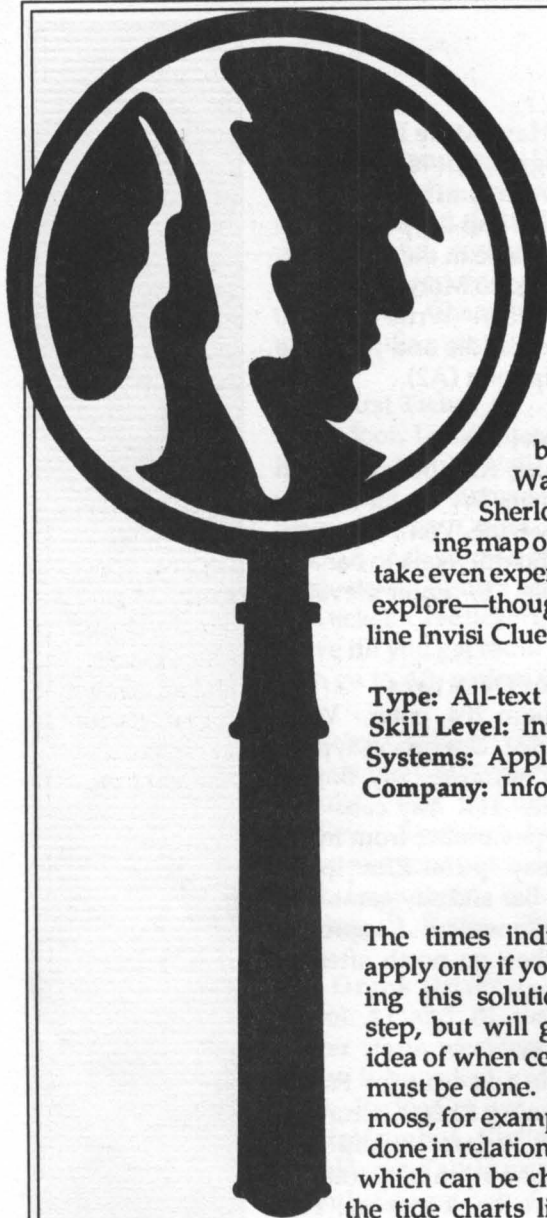

Sherlock Holmes and the Riddle of the Crown Jewels

Infocom's final all-text adventure, *Sherlock Holmes*, takes a different tack than the dozens of other games based on Conan Doyle's legendary British sleuth, for you view the events through the eyes of Dr. Watson rather than of those of Holmes. That's because Holmes' eternal nemesis, Moriarty, has set a trap for him, so Watson spearheads the investigation of the missing Crown Jewels. Sherlock assists with occasional clues. The search takes place on a sprawling map of London and must be completed in 48 hours of game time. It should take even experts a while to finish this one, for it's filled with puzzles and places to explore—though you can accelerate the process by consulting the program's on-line Invisi Clues.

Type: All-text Mystery
Skill Level: Intermediate
Systems: Apple II, C 64/128, IBM, Amiga, Macintosh, ST
Company: Infocom/Activision

The Solution

The times indicated here apply only if you're following this solution step-by-step, but will give you an idea of when certain things must be done. Getting the moss, for example, must be done in relation to the tides, which can be checked with the tide charts listed in the

newspaper included with the game.

221 B Baker Street

Knock on door. U. N. Tell Holmes about visitor. Get pipe, tobacco, newspaper. Put tobacco in pipe. Wait. Read verse. Wait. W. Get ampoule, lamp, glass. Examine ampoule. E. S. D. N. Get matchbook. Read matchbook. S. Open door. E. Light lamp. S (3). SE (2). Take off hat. Get stethoscope. Put **bnqpvmf** in **ibu**. Wear hat. E (2). Read sign. Ask Holmes about ampoule. Wait until 7:00. E.

Nave and Westminster Abbey

S. SE. Get packet, crayon. Open packet. Get brown, yellow, orange. NW. Open door. S. W. Read sign. E. N. N. Examine tomb. Put brown paper on tomb. Rub it with crayon. Get paper. E. N. E. Examine tomb. Put orange paper on tomb. Rub it with crayon. Get it. S. W. Examine tombs. Put yellow paper on Henry's tomb. Rub it with crayon.

Get it. E. N. W. N. Look. **Ifbu** orange paper with **dboemft**. **Sfbc** **cbdl** of orange paper (repeat with brown and yellow papers). S (2). W (2). NE. N. E. D. Look in boat. Get oar. U. Turn off lamp. W. Blow whistle (2). Get in cab. The Embankment. Get out.

The Embankment

Get in boat. Put **pbs** in **pbsmpdl**. Weigh anchor. Launch. Row east (2). Drop anchor. Examine bridge. Examine moss. Wait (until 8:40 or next high tide). Get moss. Weigh anchor. Row west (2). Land. Get out. Examine opal. Examine opal thorough magnifying glass. Blow whistle (2). Get in cab. Birdcage Walk. Get out.

Birdcage Walk

Haggle with vendor (2). Buy telescope. E. N (2). Examine Nelson through telescope. NE. N.

Convent Garden

Wear stethoscope. **Mjtufo** to girl. Open bag. Open blue bottle. Drop crayon, packet, all paper. Get cotton, newspaper. (If the girl's heartbeat was too fast, give her the orange pill. Otherwise, open the brown bottle and give her the yellow pill.) Take off stethoscope. N. E. S. W.

Sherman's Shop and the Ruby

Ask Sherman about pigeon. Ask Sherman for pigeon. E. Blow whistle (2). Get in. Trafalgar Square.

Driver, wait here. Get out. Show svcz to qjhfpo. Qjhfpo, get svcz. Let go of qjhfpo. Get in cab. Pinchin Lane. Driver, wait here. Get out. W. Ask Sherman about qjhfpo. Examine svcz through glass. E. Get in cab. Marylebone Road. Get out.

Marylebone Road and Madame Tussaud's

N. Ask guard about cigarette. Open matchbook. Light match. Light pipe. Drop matchbook, lamp. N. Ask Holmes about ash. W. Get upsdi. Mjhiu ofxtqbqfs with qjqf. Mjhiu upsdi with ofxtqbqfs. Get ifbe. Nfmu ifbe with upsdi. Get gem. Examine gem through glass. E. S. Get lamp. Blow whistle (2). Get in cab. Parliament Square. Get out.

Parliament Square

SE. U. Put dpuupo in fbst. Wait until 12:00 (or whatever the next hour happens to be). Get sap-

phire. Wait. Get sapphire. D. Remove dpuupo. Examine sapphire through glass. NW. N (2). NE. N (2). E (2).

Threadneedle Street and the Bank of England

Examine urchin. Ask Holmes about guard. Wiggins, get keys. Give tijmmjoh to Wiggins. Wiggins, get keys. N. Give bmm hfnt to hvbse. N. Xfbs tufuiptdpqf. Mjtufu to epps. Uvso ejbm sjhiu (2). Uvso ejbm mfgu. Uvso ejbm sjhiu (2). W. Take off tufuiptdpqf. Vompdl cpy 600 with lfz. Get topaz. Examine topaz through glass. E. S. Blow whistle (2). Get in cab. Trafalgar Square.

Trafalgar Square and the Password

Driver, wait here. Get out. W. Ask butler for Mycroft. Give sjoh to butler. (Remember password.) E. Get in cab. Tower of London. Get out.

Tower of London

E (2). (Say the password from Mycroft.) N (2). SE. U. Get weapon. D. NW. NE. Hit bung with nbd. Look in keg. Xjhjhjot, hfu hbsofu. Examine hbsofu through glass. SW. E. D. Xfbs bsnps. U. W. S (3). Get paddle. Qvmm dibjo. Ublf off bsnps. S. Get in boat. Weigh anchor. Launch. Paddle west (3). Land. Get out. E (2). D. Wait until 2:00 a.m. Monday. W.

Bar of Gold

Btl for Blcbs. Txpsegjti. Give hbsofu to Blcbs. Ask Moriarty about jewels. Take off hat. Get bnqpvmmf Ipme csfbui. Break bnqpvmmf Untie Holmes. Tie up Moriarty and Akbar. Get jewels, whistle. Get key. Unlock door with key. Open door. Out. Blow whistle (2). Get in cab. Queen's Gardens. Get out. Give jewels to guard.

Map Key: Sherlock Holmes

- A: Pipe
- B: Tobacco
- C: Newspaper
- D: Ampoule
- E: Lamp
- F: Glass
- G: Matchbook
- H: Pacquet
- I: Crayon
- J: Oar
- K: Telescope
- L: Pigeon
- M: Ash
- N: Torch
- O: Axe
- P: Head
- Q: Password
- R: Mace
- S: Armor
- 1-6: Jewels

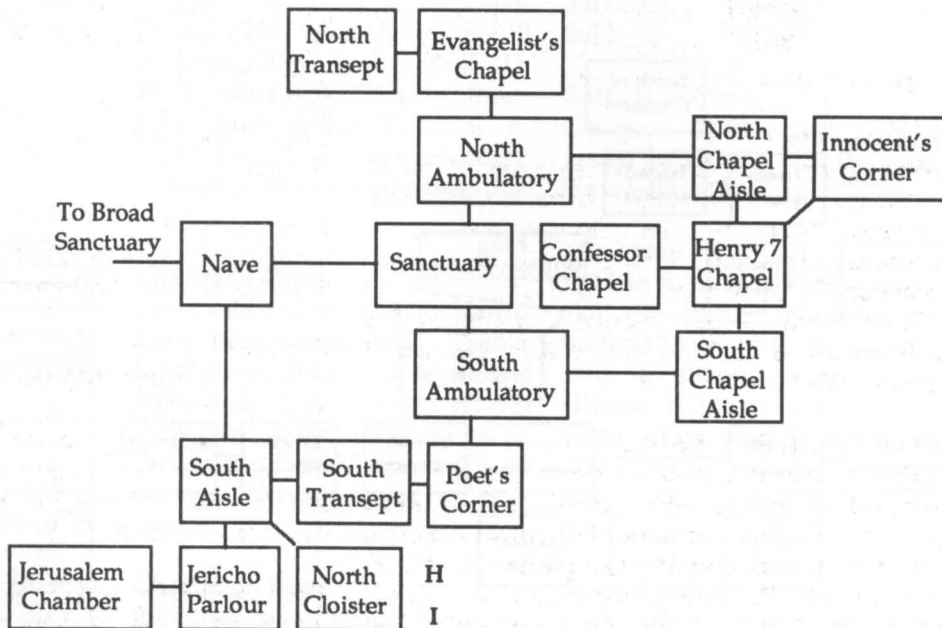

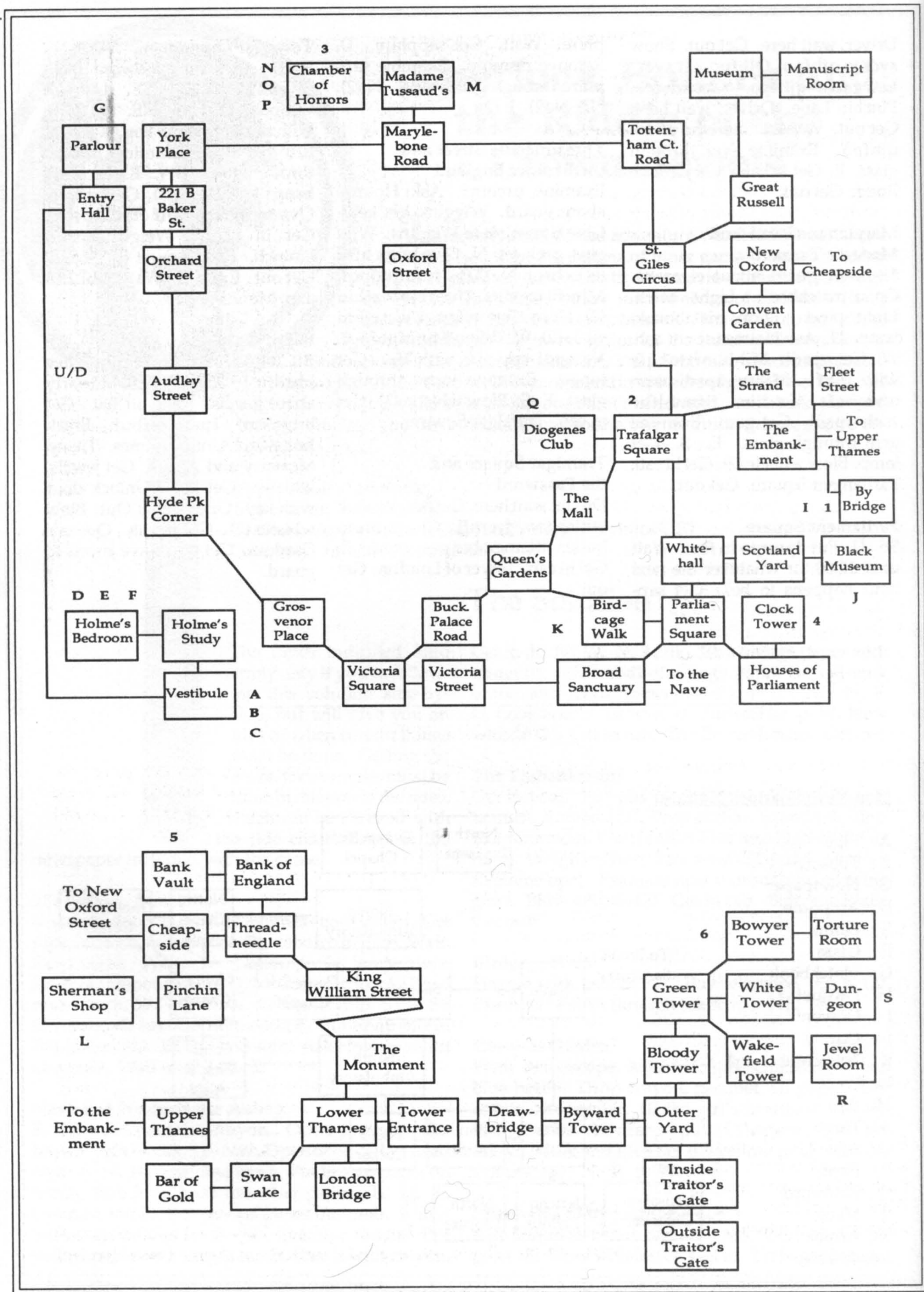

Space Quest II: Vohaul's Revenge

Sludge Vohaul, the mad scientist you stopped from destroying an entire planet in *Space Quest I*, has come up with an insidiously original means of wreaking revenge—by scattering thousands of obnoxious, door-to-door insurance salesmen across Xenon, your home planet. And since he took your previous deeds so personally, he's out to get you too. As Roger Wilco, you'll be captured almost immediately and sent to a prison planet to work in the mines. From there you'll (hopefully) escape and eventually make your way to Vohaul's asteroid fortress. Besides Sierra's clever logical puzzles, you'll find several arcade-style challenges (none too tricky) and plenty of the off-the-wall humor for which the *Space Quest* series is so well-known. The artwork, parser and other elements are top-notch, though the program was produced with Sierra's previous game system, so it lacks the double-resolution graphics and complex musical scores of those that followed *King's Quest IV*.

Type: Animated Adventure

Skill Level: Intermediate

Systems: IBM (256K), Amiga, IIGS, Apple (128K), Macintosh, ST

Company: Sierra On-Line

The Solution

This solution starts at the crash site on the planet, since the first part of the game is automated. Some words are to be typed in; other orders are conducted via stick, mouse or keyboard.

Crash Site and Deep Forest

Walk to hovercraft. Look in hovercraft. Push button. Walk to guard. Tfbsdi hvbse. Hfu lfdzdbse. N. E. Walk to creature. Untie rope. W. W. Get spore. N. Move through roots maze without touching them. Get berries. Return to clearing.

Clearing

E. W. (Upper Passage) When aerial attack occurs, hide behind bush and wait for enemy to leave. Walk to mailbox. Qvu gpsn jo nbjmcpy. Get whistle. E.

Woods and the Cave

E. (Upper Passage) Svc cfssjft on vojgpsn. E. Walk to deep spot (center-right, towards top; you'll be swimming). Ipme csfbui. D. W. U (into cave). Get gem. Enter pool. Ipme csfbui. E. U. E. E. Climb tree. E. E. (You get caught in snare.) Wait till you pass out. Wait.

The Oaf's Camp

Talk to oaf (twice). Wait for him to move beside cage door. Throw tqpsf at oaf. Get key. Unlock cage. Open door. Get rope. N. W. W. (Stay close to bottom of screen to avoid getting shot.) [Save] Climb on log. Tie rope to log. Climb rope.

Chasm, on Rope

Move to end of rope. Swing on rope. Wait till you have good

momentum, then Let go as you swing toward left side. W. Enter darkness. Hold gem. W. (You will fall.)

Bottom of Chasm

Get gem. Follow pink guys (S). Listen to chief. Say the word. [Save] Enter hole.

The Maze

Put hfn in npvui. Follow map to exit the maze, avoiding part marked "Avoid." E. N (take right exit). E. (Stay in water.) Cmpx xijtumf. Wait for beast. Get out of water when beast is at opposite side of screen. Throw qvaamf at beast. Walk to hole in rock. Get rock.

Base of Tower

If you have the keycard: Sneak under platform (hide behind

bushes, etc., when guard goes right after stopping). Throw rock. (If you didn't get keycard earlier: Throw *spdl* at guard with supporter. Walk to guard. *Tfbsdi hvbse*. *Hfu lfzdbse*.) Walk to elevator. Take elevator to top of pad.

Top of Tower

Move behind shuttle. Open door. Push power button. Set dial to **WBD**. Push thruster button. Pull throttle. Wait till you leave the atmosphere. Set dial to **IBD**. Push throttle. Wait for Vohaul to contact you. Wait to enter Fortress.

Dock

(If a waxer approaches at any time in the Fortress, turn around, leave the level and return.) Wait to land. E. *Foufs fmfwbups*. Look. Push three. Wait. Exit elevator. E. (3). Push button. Enter closet. Look.

Get plunger. Get out. E (3). Enter elevator. Push four.

Level Four

W (2). Push button. Enter closet. Look. Get cutter. Leave closet. W. Go to door on left. Push button. N. Walk to third stall. Open door. Enter stall. *Hfu upjmfu qbqfs*. Exit stall. S. W (3). Enter elevator. Push five.

Level Five

E (3). Push button. Enter closet. Look. Get basket. Get overalls. Get lighter. Put paper in basket. W (3). Enter elevator. Push one. W. S.

South Tube and the Wallbots

Walk down stairs. W. (Barrier appears.) E. (Barrier appears.) Wait till floor opens *uisff-rvbsufst* of the way, revealing acid pit, then stick *qmvoahfs* to barrier. Wait for

floor to close. Let go. Drop basket. *Cvso qbqfs* (must be in basket). Wait for sprinklers to start. E. E.

Vohaul's Chamber

Climb stairs. (You get zapped.) *Dvu hmbtt*. Walk to vent. Enter vent. Push button. Exit vent. W. Walk to switch. Pull switch. Type *fombshf*. E. Enter glass. *Tfbsdi* Vohaul. Look at screen. Type **TITS** (aborts salesman launch.) Return to normal view.

Glass Tube

Look at box. Open box. Wear *nbtI*. E. S. W (2). Type "push button" but don't press enter yet. W. Move to button and press enter. E. (Robot will follow.) E (5). (Robot stops following.) Return to shuttle tube. Get in pod. Push button. Wait

Pod

Look. Walk to chamber. Open chamber. Get in chamber.

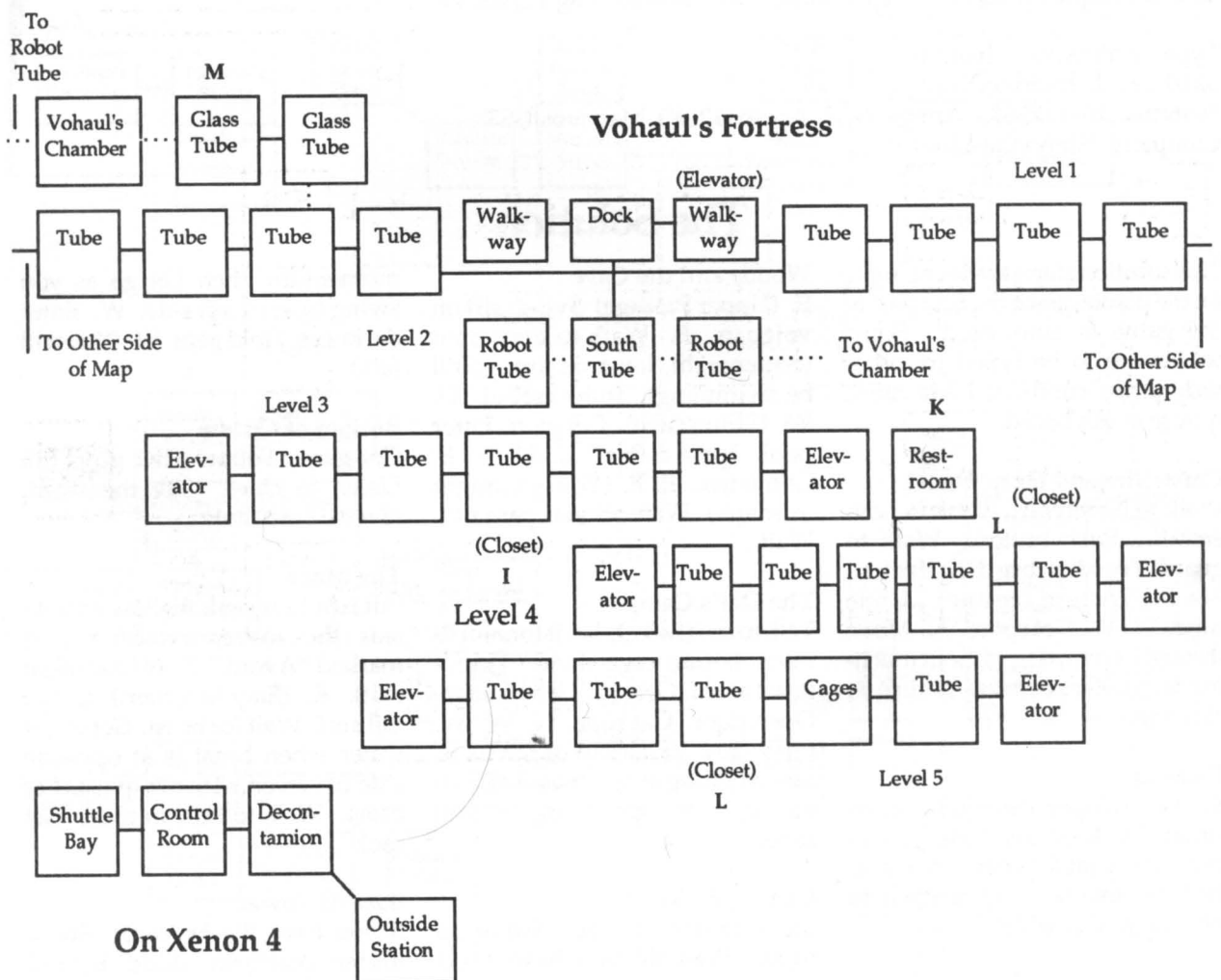

Map Key: Space Quest II

- A: Keycard
- B: Creature. rope
- C: Spore
- D: Berries
- E: Mailbox, whistle
- F: Gem
- G: Key, rope
- H: Chief
- I: Plunger
- J: Glass cutter
- K: Toilet paper
- L: Basket, overalls, lighter
- M: Mask

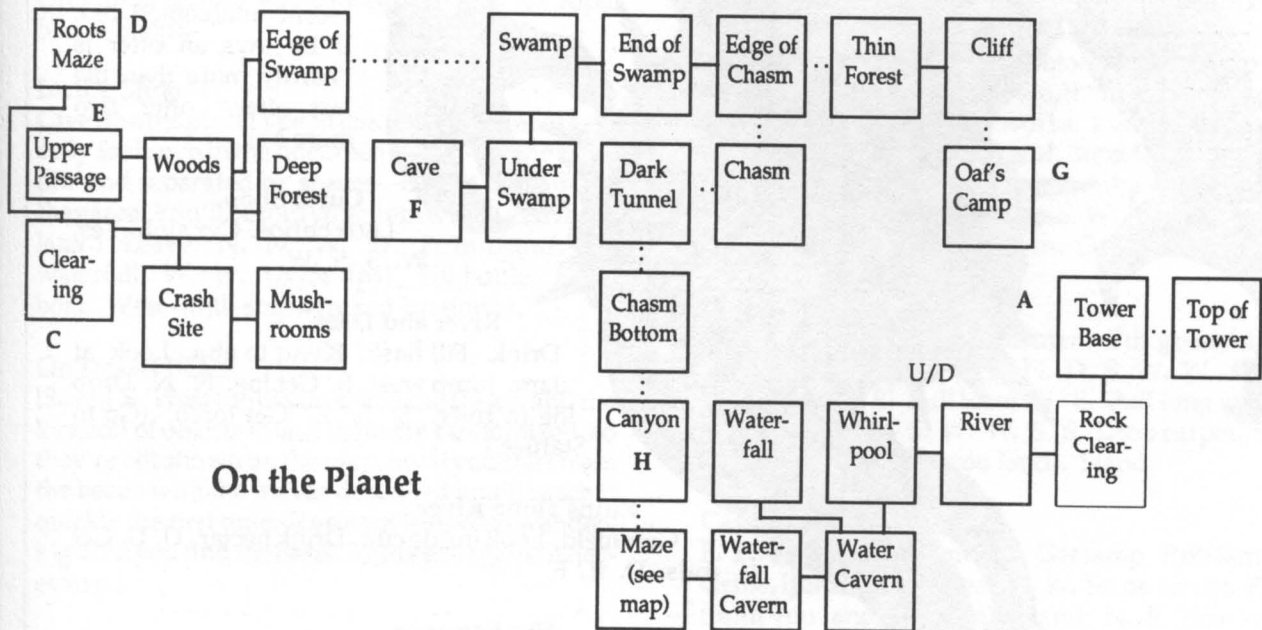
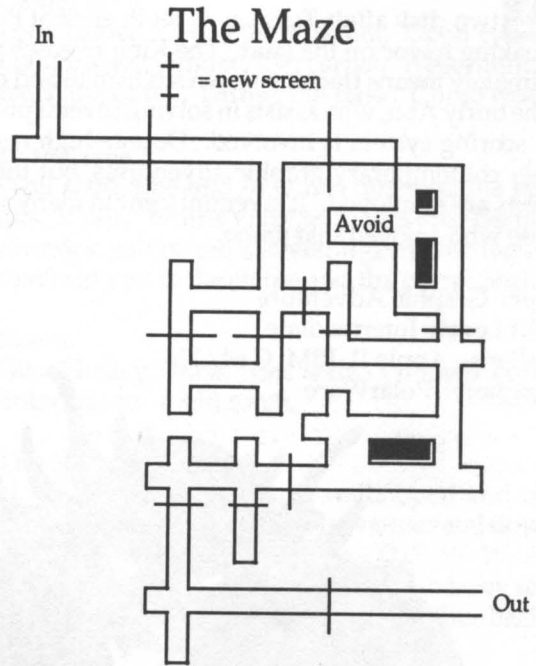

TALISMAN

A two-disk affair, *Talisman* is set in ancient Persia, where a wave of plagues and other disasters are wreaking havoc on the land. The King releases you from Death Row to do something about it, which ultimately means tracking down a talisman and dealing with a nasty Demon. Your sidekick on the trip is the burly Abu, who assists in solving several puzzles and contributes a sense of humor to your journey. No scoring system is involved. Double-high resolution graphics are available; they're not as crisp as other contemporary graphic adventures, but the parser is above average for such games. No sound effects are employed. It is reminiscent in many ways of *Ring Quest* and is especially recommended for those who enjoyed that game.

Type: Graphic Adventure

Skill Level: Intermediate

Systems: Apple II, IBM, C 64/128

Company: PolarWare

The Solution

Cell

Move brick. Wait. Bow. Leave. S. S.

Bazaar

W. Talk to Hosni. Buy flask. (For a low price, "offer 7," then when told it's too low "offer 10," then 11. Keep offering one more than your most recent unaccepted bid. If he says an offer is "hardly more than the last offer," offer two more.)

Curio Shop

Look curios. Cvz sjoh. Yes. W. S. S. W.

River and Dam

Drink. Fill flask. Kvnq to ebn. Look at dam. Jump west. S. Get log. N. N. Drop log in river. S. S. E. Get torch. (Go to Statues.)

Ruins along River

Get shield. Look inside cup. Drink nectar. U. U. Get rods. D. E. E.

Hut Entrance

Put pozy spe in hole 1. Put qfbsm spe in hole 2. Put fnfsbme spe in hole 3. Put ojdlfm spe in hole 4. Push button. Enter hut. Get lamp. Leave. W. S. E. (Wait for hare, he's not here now.) Give sjoh to hare. Get hare. W. S. E.

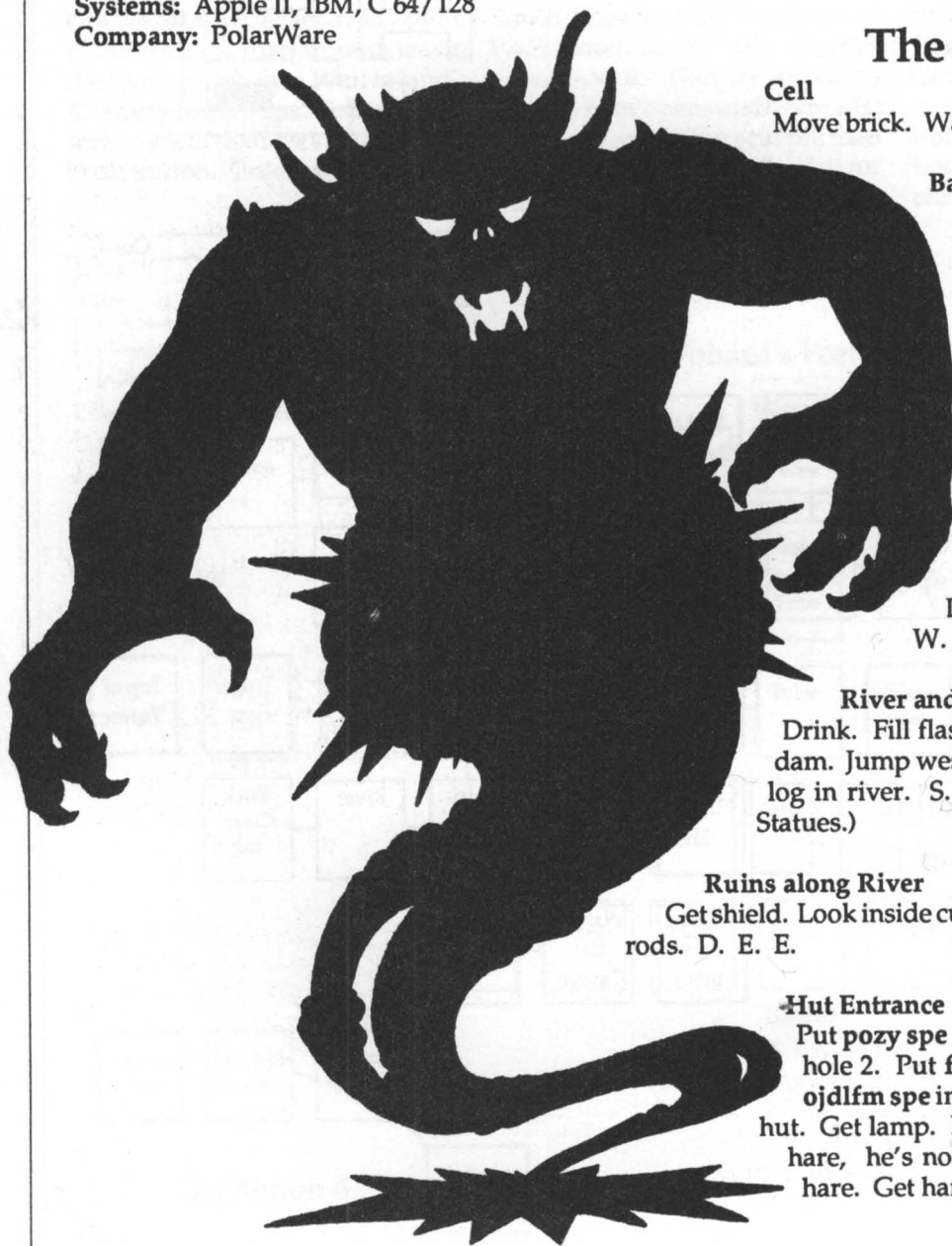

Village

Talk to villagers (until drunk tells where he hid the catalog, then go to Bridge.)

Bridge

(Wait for bottle if it's not here now.) Wait (until bottle is under bridge). Look under bridge. Get bottle. N. E. N.

Palace

W. Ask executioner to open door. Enter cell. Npwf brick. Reach inside chamber. Get catalog. Leave. (Go to Pit.) Drop ibsf in pit. D. Look debris. Get coins. Get flint (when ibsf hiccups it out). U. W. N. N. W. W.

Hosni

Buy rope (use same bargaining tricks). Leave. N. W. [Trail] S. S. S. S. E. S. E. E. S. S. W. Fight bandits. W. S. Throw rope at tree. Climb rope. Swing from rope. Light lamp. E. E. Svcmbnq. Put out mbnq. Talk to wizard. Yes. W. W.

Cave Entrance

(Enter all-text mode and watch the description window at the top. Wait for the message "Rope is at the furthest point from cave." Wait once more and you'll see "Rope is swinging toward the cave." Only then should you proceed.) Jump for rope. (Go to Shop.)

Inside Shop

Give dbubmph. (Type in credit card numbers exactly as shown in the documentation—on the same line and separated by spaces—or you can't finish the game. You'll be told your item will be delivered later.) Leave. N. N. W. W. Pqfo tftbnf. Go waterfall. W. W. Uxjtu dpsl. Fill bottle. Enter boat. West (until shipwrecked by storm).

On Desert Beach

[Save.] S. West (until you see oasis. Desert and the location of objects found there are randomized, so they're not shown on the map, but if you start from the beach with the moves described you'll reach it quickly the first time. If you get lost, keep wandering until you find the oasis. Restore the game if necessary.)

Oasis

Get figs. Abu, kill snake. Get figs. Drink. Abu, drink. Fill flask. W. W. N. N. N. (Sometime during these moves, you'll be told a camel is in a certain direction from you. Go in that direction. If not told about the camel, try going south for every

north move you've made, then go north again. Again, this is randomized and may require experimentation and patience.)

Camel

Look camel. Give gjht to camel. Open cylinder. Look inside cylinder. Get carpet. West (until you reach the oasis). Drink. Fill flask. Climb tree.

In the Tree

(You should be told in which direction the statue lies. If not, "dmjnc usff" until you are. Go in the direction you're told and you'll get more directions that lead you to the statue and the parrot Shelley.)

Statue

Give Shelley xbufs. Get staff. Put staff in hole. Enter statue. Light torch.

The Moving Walls

N. E. E. N. (The maze walls open and close randomly, so you may have to wait several times in order to follow these directions.) D. S. W. W. Abu, pull lever. N. E. E. Up (look to see if the way south is open; if not, go down, pull lever and then back up the hole.)

The Upper Maze

You need to see if the way to the demon is open. From the upper level where the hole is, try going S, W, W, W, S. If the way west is blocked, retrace your steps back to the hole, go down, then xftu uxjdf and pull lever. This usually works, but if it doesn't you'll have to fool around with the different levers in the bottom maze, (which open the walls in the upper maze, until you can go S, W, W, W, S from where the hole is and reach the Demon Room.)

In Demon Room

Look inside bowl. Get talisman. Put gpsuz uxpdjot in bowl. N. E. E. E. N. D. S. W. W. Abu, pull lever. N. E. Pull lever. S. E. Pull long lever. N. Pull lever. U. S. W. W. S. S. Drop carpet. Sit on carpet. Fly (until you land). Stand.

Cave Entrance

E. E. Qpvs xbufs on mbnq. Get lamp. Rub lamp. Genie, ljm m xjabse. Yes. W. W. Sit on carpet. Fly (until you land at palace). Stand. N. E. Bow.

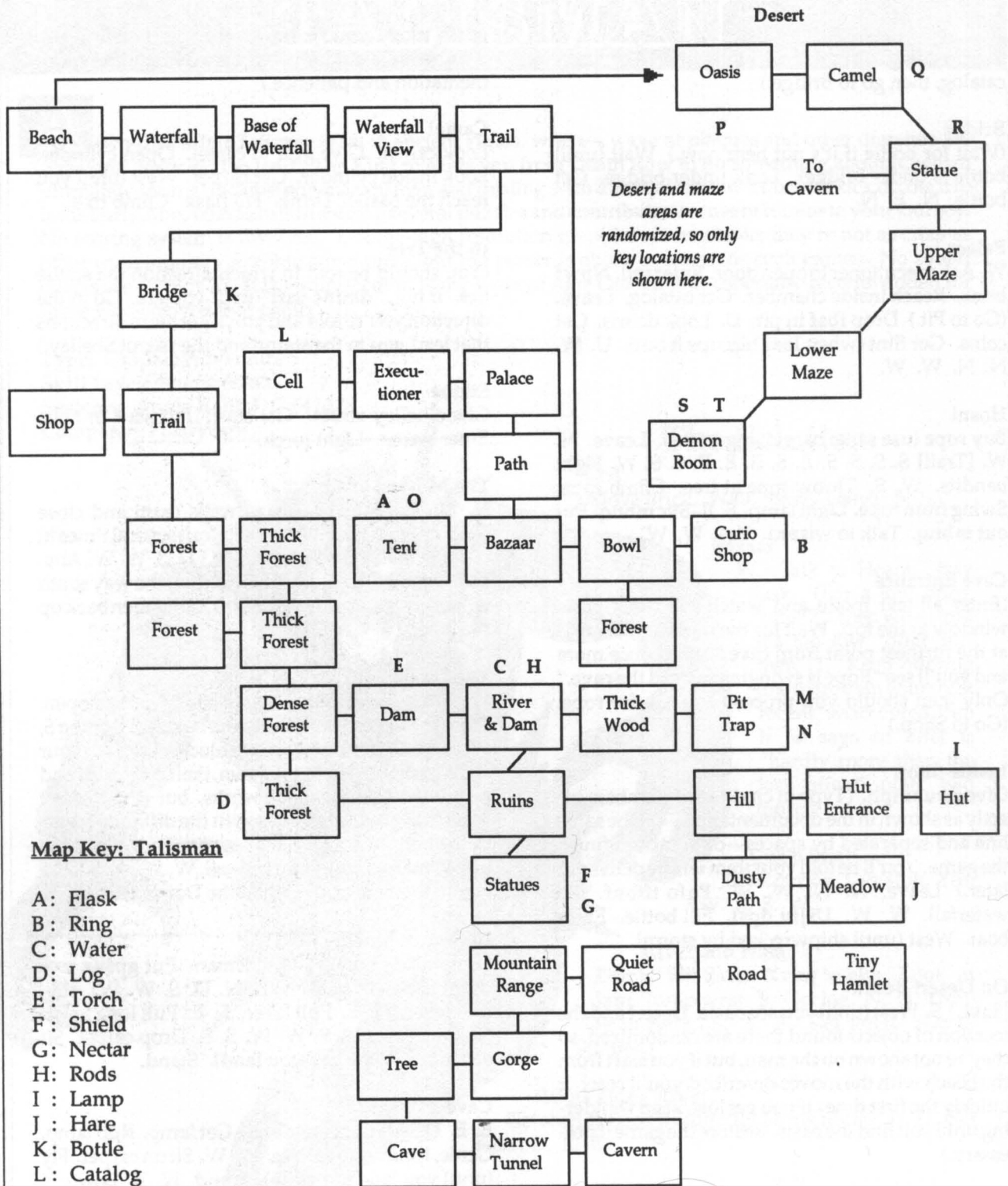

Map Key: Talisman

- A: Flask
- B: Ring
- C: Water
- D: Log
- E: Torch
- F: Shield
- G: Nectar
- H: Rods
- I: Lamp
- J: Hare
- K: Bottle
- L: Catalog
- M: Coins
- N: Flint
- O: Rope
- P: Figs
- Q: Carpet
- R: Staff
- S: Levers
- T: Talisman

TWILIGHT ZONE

Unlike most adventures, *Twilight Zone* does not unfold in a linear fashion. After leaving your home town, you jump helter skelter from a bamboo hut somewhere in southeast Asia to a burning barn in middle America, then on to an Indy 500 racer, to a fantasy kingdom and other off-the-wall locales. In the finale, everything is explained, complete with the "O'Henry" type twist ending for which the TV series is so famous. The explanation is a bit trite, but it does nominally tie the rest of the game together for people who want continuity. The graphics are excellent, and there are plenty of them. Puzzles are logical, but the game is literally filled with red herring objects. And the parser is above-average, recognizing pronouns and including an "undo" option.

Type: Illustrated Text Adventure

Skill Level: Intermediate

Systems: IBM (512K, CGA required; supports EGA and Tandy), C 64/128, Amiga, Apple

Company: First Row Software

The Solution

Bedroom

Get up. Get wallet and money. Turn on TV. Get clothes. Wear clothes. Put money in wallet. Put wallet in pocket. E. Look at pictures (repeat for several clues). D.

Living Room

Save. (If unable to leave the house immediately, wait to pass time.) E.

From Front of House to Railroad Station

N(4). (Front of Train Station) NE. Get in line. Buy ticket. W. W.

Train

Get all (pendant, newspaper, card). Examine pendant. Examine newspaper. Read paper. Look at card. Put dbse in qfoebou. Wait. Get off train. E. S.

Lobby & Houghton Street Construction Site

Xbwf qfoebou at reaper. Save boy. Get locket. S. S. E. Get brick. Drop paper. E. S. E.

Houghton & Hermann

Uispx csjdl at window. E. (You're transported to next location.)

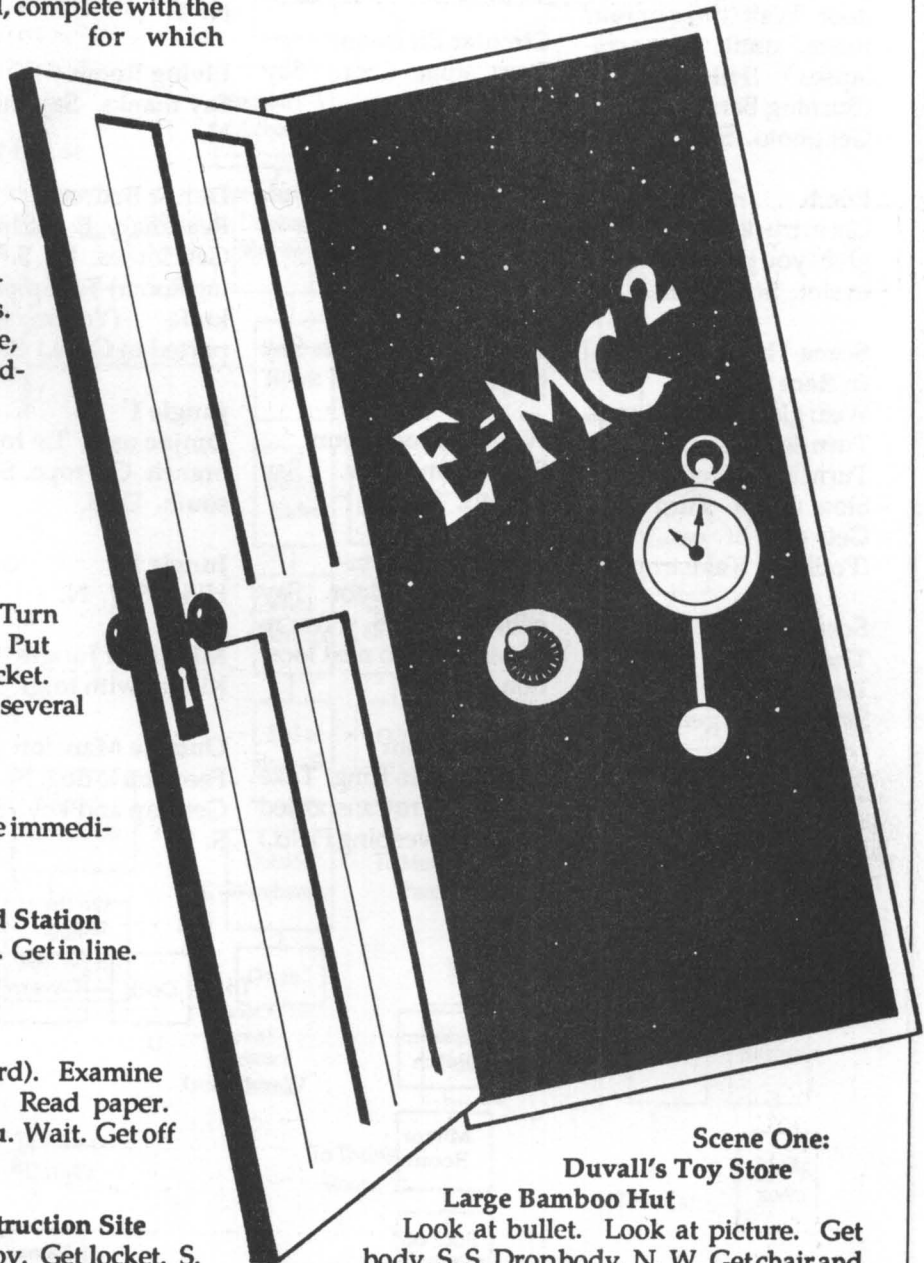

Scene One:

Duvall's Toy Store

Large Bamboo Hut

Look at bullet. Look at picture. Get body. S. S. Dropbody. N. W. Get chair and shovel. E. SW. Get all (two ropes). NE. S.

Crest of Hill

Break the chair. Get wood. Make a dsptt with wood. Dig a grave with shovel. Take body. Bury body. Put

dsptt on grave. (You're transported to next location.)

Scene Two: Americana Picket Fence
Get hammer. E. N. N. U.

Hayloft & Barn
Look at girl. Ujf spqf to girl. Lower girl through door. Wait (three or four times, until floor collapses.) Hit wall. S. (Burning Barn) Get girl. Get photo. S.

Porch
Get in truck (after woman gives you keys). Put keys in slot. Start truck.

Scene Three: Formula I In Race Car
Wear gloves. Step on gas. Turn left. Step on gas. Turn left. Step on gas. Slow down. Turn right. Get out of car. Up. (Podium) Take trophy.

Scene Four: The Sad King Theme Room
Stand. Take gem. N. N.

Natural Room
Look at the door. Put cvmmfu in slot. NE.

Iron Door Room
Read writing on iron door. Say xbs. N.

Wooden Door Room
Read writing on wooden door. Say tjdlloftt. NW.

Circular Pit Room
Read stone door. Say ujnfn. N.

Demon Room
Read pedestal. Say efbui. Get sword. Put hfn in sword. S.

Circular Pit Room
Read wooden door. Say ujnfn. SE.

Wooden Door Room
Read iron door. Say ifbmui. S.

Iron Door Room
Read bronze door. Say qfbdf. SW. S. (You're transported to next location.)

Theme Room
Give txpse to King. Take gem. (You're transported to Long Sweeping Field.) Exit.

The City

In Front of Duvall's Toy Store
W. S. W. W. S (3).

From the Ocean to the Island
S. (Ocean) Swim north. (Beach). N. N. (Outside Mansion) Ring doorbell. N. E.

Living Room
Say thanks. Say thanks. N.

Den & Bedroom
Read diary. E. (Bedroom) Get clothes. W. S. (Living Room) Take rope and knife. (You're transported to Cave.) S.

Jungle I
Dmjnc usff. Tie rope to branch. Get rope. Swing south. D. S.

Jungle II
Hide. SW. N.

Middle of Jungle
Kill rat with lojgf. N.

Outside Mansion
Feed sbu to dog. N. E. N. Get trap and key. S. W. S. S.

Middle of Jungle to Dock
Set trap. Dpwfs trap with mfbwft. Wait. Ujf hunter with spqf. Drop card. N. NW. W. (Dock) Get in boat. Start boat. (You're transported to Ocean south of Warehouse.)

Outside Warehouse
N. N. E. S. (Odd-looking Fence) Unlock gate. S.

Museum Porch
Sfgmfdulasers with hfn. S.

Mirror Room to Cramped Hallway
Look at lights. Press button uxp. Press button gpvs. Press button uisff. Press button pof. Press button uisff. S. (Foot of Stairs) SW. W.

Cramped Hallway
Examine locket. Put qipup in mpdlfu. Look at door. Look at imprint. Put mpdlfu in tmpu. W.

Arena
Wait. S.

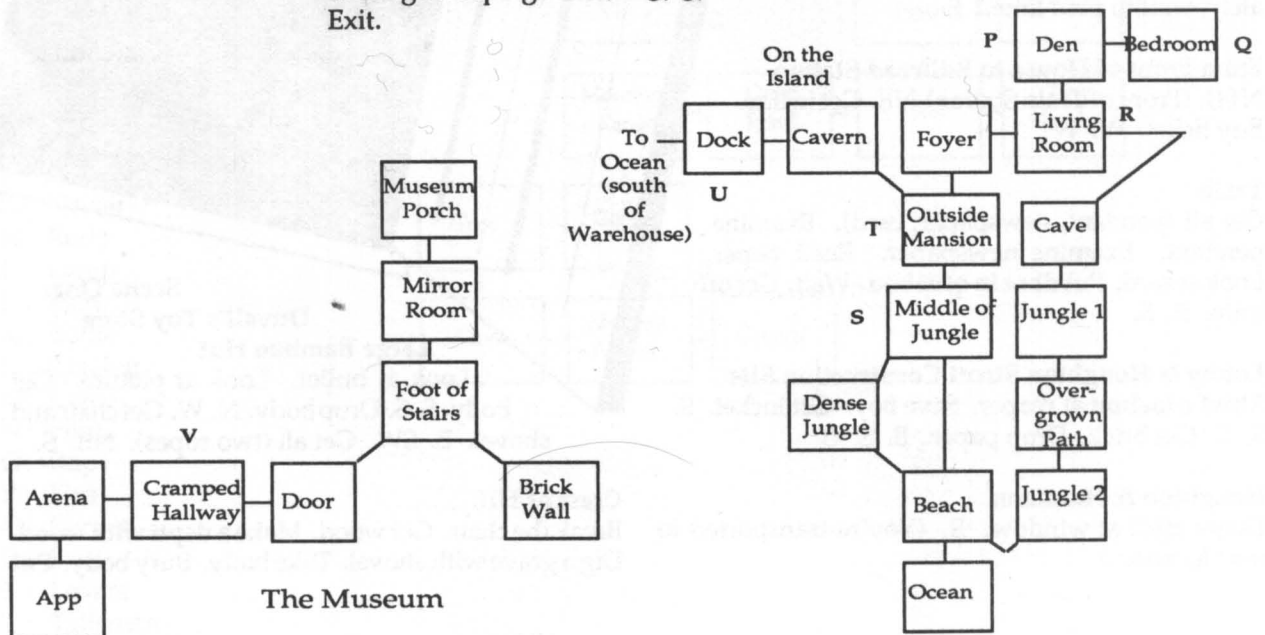

Map Key:
The Twilight Zone

- A: Wallet, money, clothes, pictures
- B: Ticket
- C: Pendant, newspaper, card, newspaper
- D: Locket
- E: Brick
- F: Bullet, body
- G: Chair, shovel
- H: Two ropes
- I: Hammer
- J: Photo
- K: Keys, truck
- L: Gloves
- M: Trophy
- N: Gems
- O: Sword
- P: Diary, trap, key
- Q: Clothes
- R: Rope, knife
- S: Rat, hunter
- T: Dog
- U: Boat

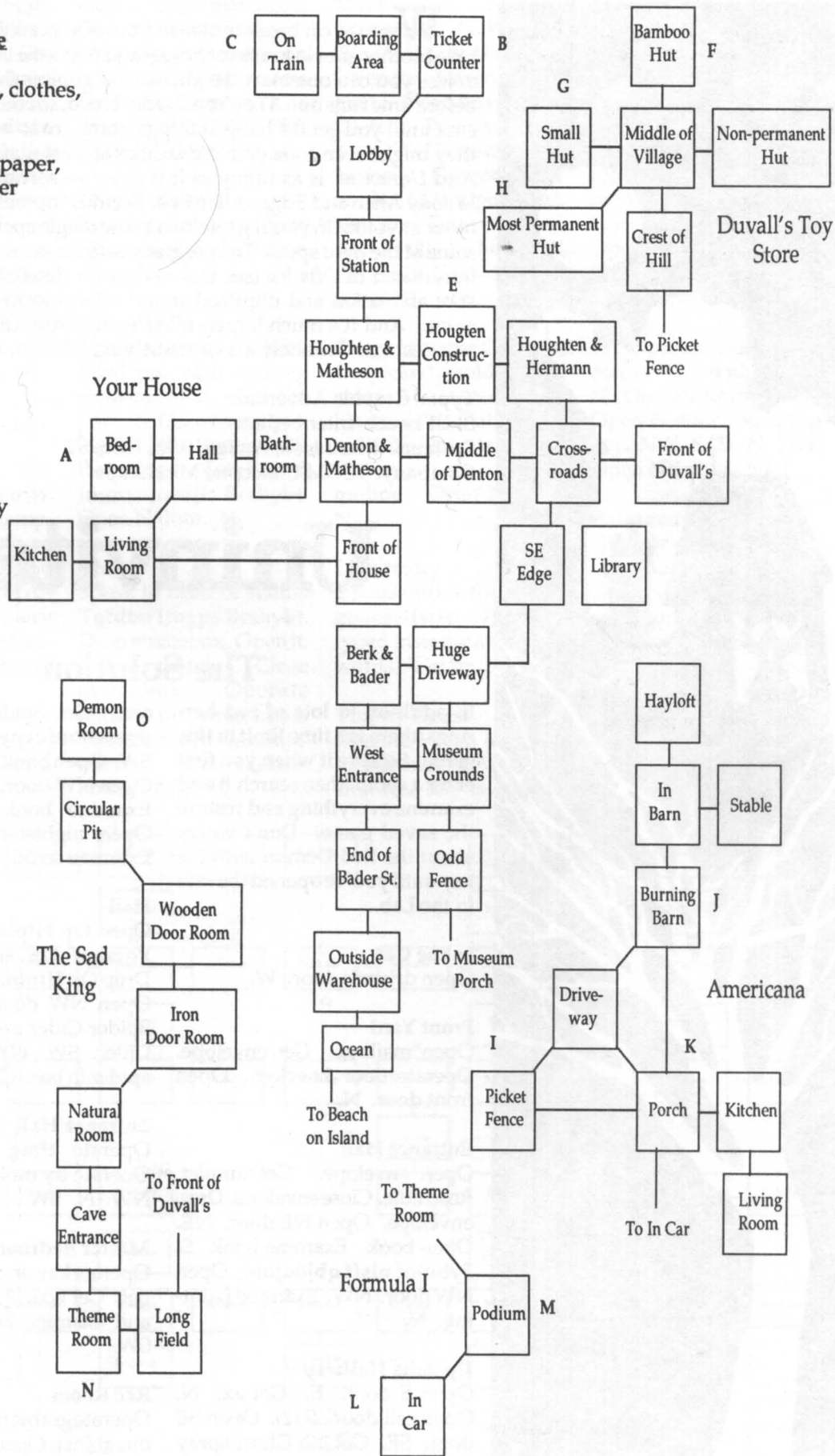



When the car breaks down in front of a spooky old mansion, your little brother goes in to ask for help—and that's the last you'll see of him unless you can outsmart the ghosts and goblins that haunt the place before time runs out. They're a deadly breed, so count on getting killed a lot until you get the hang of things; some are so well-illustrated that they might even *scare* you to death, or at least make your skin crawl. And *Uninvited* is as funny as it is scary — sort of a combination of Woody Allen and Edgar Allen Poe. Besides "operating" items on each other or yourself, you'll get to cast a few magic spells to help you past some of the tight spots. The program uses the same icon-based system introduced in *Déjà Vu* (see that review for details), but the graphics, spot animation and digitized sound effects were improved for this game. And it's much larger, filled with harder (though still logical) puzzles, and definitely a more satisfying adventure than *Déjà Vu*.

Type: Graphic Adventure

Skill Level: Intermediate

Systems: Macintosh, Amiga, IBM, IIGS, ST

Company: ICOM Concepts/Mindscape

Uninvited

The Solution

In addition to lots of red herrings, there is a time limit in this game. So save it when you first enter a room, then search it and examine everything and restore the saved game. Don't worry about the Red Demon with the key until you've opened the safe in the Lab.

In the Car

Open driver's door. W.

Front Yard

Open mailbox. Get envelope. Operate door knocker. Open front door. N.

Entrance Hall

Open envelope. Get amulet. Read note. Close envelope. Drop envelope. Open NE door. NE. Open book. Examine book. S. Fybnjof uisff qbjoujoht. Open NW door. NW. Examine painting. N.

Upstairs Hallway

Open E door. E. Get ax. N. Open cell door. S (2). Open SE door. SE. Get No Ghost spray

can. Get Spider Cider can and dpssvhbufe cpy. S. Open SW door. SW. Open book. Examine book. S. Open NW door. NW. Open book. Examine book and nightstand. Open nightstand. Open scroll. Examine scroll. S (2).

Hall

Open Op Hiptu. Open SW door. Pqfsbuf Op Hiptu on Woman. Drop Op Hiptu. Open SE door. SE. Open NW door. NW. Operate Spider Cider on rail. Drop Spider Cider. SW. NW. Open box. Put spider in box. Close box. SW. S. E.

Entrance Hall

Operate tfmg on mfgu dibjs. Operate by on left chair. Get key. NW. N. SW.

Master Bedroom

Operate key on cabinet. Open cabinet. Get box. Examine box. Open and examine both scrolls. S (2). SW.

Rec Room

Operate gramophone. Operate key on cabinet. Open cabinet and speak

to doll: **Tqfdbo Ifbgpe Bcsbybt**. Close cabinet. Open E door. E. Get bouquet. Open NW door. Open N door. N. (The following series results in the combination to the safe.) Open desk. Examine card. Write down **bupnjd ovncfs** of **Nfsdvsz**. Drop card. Examine and drop remaining cards until you have written down the **bupnjd ovncfst** of **Tjmwfs** and **Hpme**. NW (2).

Kitchen

Open E door. E. Get matchbox. S. Open W door. W. Operate lamp. Open corrugated box. Operate spider on ghost. Close and drop corrugated box. Open diary behind painting and examine it. S (2). Open SE door. SE. E.

Entrance Hall

Open matchbox. Get a

match. Close matchbox. Operate match on matchbox. Operate match on firewood. Drop match. Put box in fireplace. Get Brass Star. NW. SW. Open NE door. NE.

Trophy Room

Operate by. Get cage. Open NE door. NE. N. Open door. N.

Greenhouse

Operate water on dirt-filled pot with nothing growing in it. Get the pot. S (2). Drop pot. [Save] NE. Speak to either dog: **Jotubounv Jmmvnjobsjt Bcsbybt**. Open N door. N.

Chapel

Speak to head of statue: **Tqfdbo Ifbgpe Bcsbybt**. Drop matchbox. Open it. Get a match. Close matchbox. Operate match on matchbox. Operate match on candleholder. Get candleholder. NW. N.

Maze

Espq nbudi. N. W (2). N (2). W (2). N (4). E (4). Operate **bnvmfu** on ghou. Drop **bnvmfu**. E (2). S (2). Put **cpvrvfu** on cross. W. Operate key on keyhole. Operate **dbhf** on bird. S (2). Open **dbhf**. Get gem. Drop cage and key. N (2). E. N (2). W (6). S (4). E (2). S (2). E (2). S (3).

Chapel and the Creature

Drop candleholder. Get cross. S (2). Get **qmbou**. [Save] NW. Put gem in **ojdif**. N. Operate **qmbou** on creature. Drop **qmbou**. Open N door. N.

Laboratory

Open safe (**tfwfouz-ojof**, **gpsuz-tfwfo**, **fjhiuz**—typed in as numbers, not words). Get jar. SE. S (3).

Trophy Room

Operate by on jar. Put **dpplj** under polar bear's chin (the key is hard to

see if it's anywhere else in the room, and hard to pick up with the mouse pointer, but easy to find in the middle of the white bear's chest). Examine various things in the room until the Red Demon shows up. Get the key. NE. NW. N (2). Open trap door in floor. [Save] W.

Cave

W. Operate **Csbt** Tubs on ice. N. Put **nbo** in pit. N. Operate key on door. Open N door. N. Drop key. NW. S (2). N. NW. Open NE door. NE.

Bathroom

Operate cold water tap. Operate hot water tap. Operate sink. Examine aquarium. Open **ibnqfs**. Examine **upxfm**. Examine mirror. Open **dfjmjoh mjhiu gjyuvsf**. N. Close hatch. Examine boy. Iju boy. Operate cross on Demon. N.

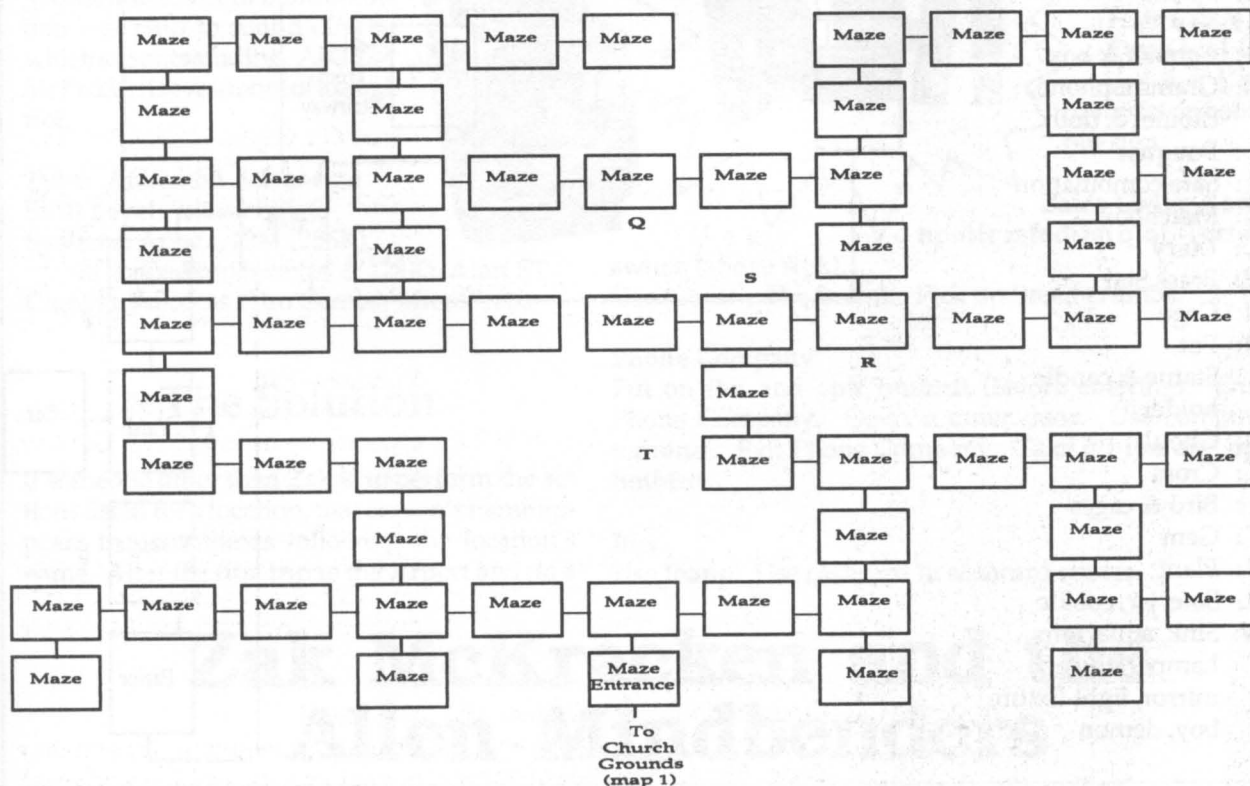

Map Key: Uninvited

- A: Envelope & amulet
- B: Book
- B2: Book & box
- B3: Book, nightstand & scroll
- C: Ax
- D: No Ghost Spray, Spider Cider
- E: Spider
- F: Key
- G: Cabinet & box
- H: Gramophone, cabinet & doll
- I: Bouquet
- J: Safe combination
- K: Matchbox
- L: Diary
- M: Brass Star
- N: Cage
- O: Pot
- P: Statue & candle holder
- Q: Ghoul
- R: Cross
- S: Bird & cages
- T: Gem
- U: Plant
- V: Safe, jar, cookie
- W: Sink, aquarium, hamper, towel, mirror, light fixture, boy, demon

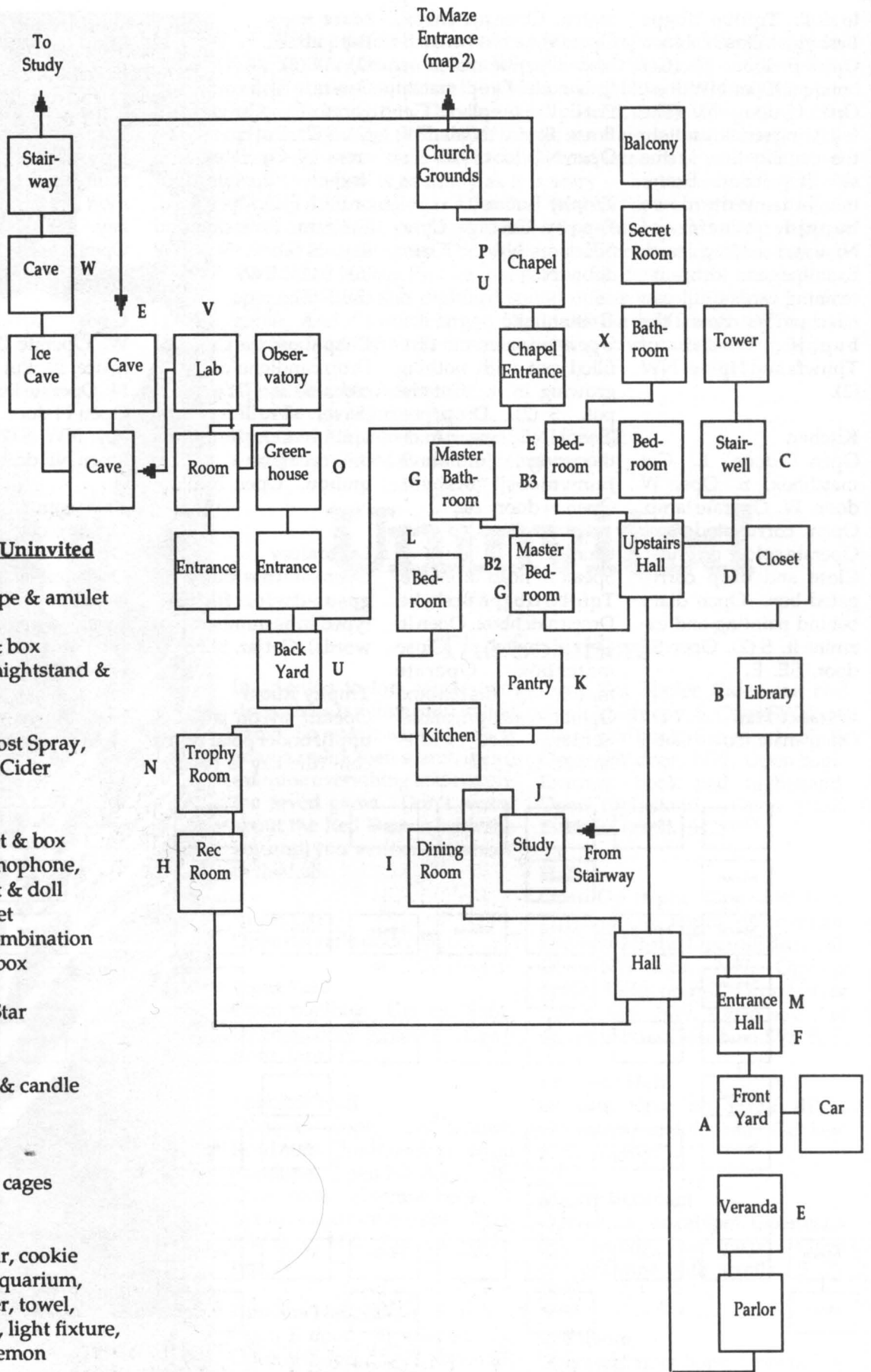

As Zak McCracken, a reporter for a supermarket tabloid called the *National Inquisitor*, your first assignment is to get the scoop on a two-headed squirrel. Then things get more serious, yet funnier, as you find a "universal stupidity epidemic" is gradually reducing the population's i.q. to zilch, and all the authorities know is that it's caused by a tone intermittently transmitted over the phone lines. Aliens from space are behind the scheme, which you hope to foil by teaming up with three female characters and traveling around the world in search of ancient artifacts needed to construct an anti-stupidity machine device. As in *Maniac Mansion*, you can switch between the characters and must get them to act in unison to solve certain puzzles. But you have to solve a few puzzles just to find the other characters in this game. Many problems have alternate solutions, though there is only one way to solve the game itself (unlike *Mansion*, with five). And several action-oriented puzzles require manual dexterity; a joystick or mouse makes these much easier. Numerous clues are cleverly concealed in satirical news stories and ads in a tabloid-size, eight-page copy of the *National Inquisitor* that accompanies the game. The interface, animation and special effects are similar to those in *Maniac Mansion*; but more attention was paid to sound effects, which are outstanding. And *Zak McCracken* is even more of a laugh riot.

Type: Animated Adventure
Skill Level: Intermediate
Systems: Amiga, IBM (256K), Commodore (64 & 128K), Atari ST
Company: Lucas Film Games/MicroProse

The Solution

If someone other than Zak is to perform the actions listed for a location, that person's name appears in parentheses following the location's name. After the first trip to the airport and on a

plane, the solution just names your next destination, omitting instructions to take the bus and use the reservations terminal. There are several Jungle mazes that are randomized and cannot be mapped, so just keep taking turns off the path (instead of going through the far left or right side exit) when possible 'til you arrive at your destination. Certain characters must do some things, such as Annie reading the scroll, but most may be performed by anyone.

San Francisco

Zak's Bedroom

Open dresser drawer. Pick up phone bill. Pick up sushi in fish bowl. Use `mbnq` with sushi in fish bowl (don't turn on `mbnq`). Pull up `upso xbmmbqbqfs`. Use `upso xbmmbqbqfs` on plastic card. Open desk drawer. Pick up kazoo.

Zak's Living Room and Kitchen

Pick up seat cushion (on sofa). Pick up remote control. Open cabinet. Pick up box of crayons. Use `zfmmpx dsbzpo` on `upso xbmmbqbqfs`. Open refrigerator. Pick up egg.

Bakery

Push doorbell (three times). Pick up stale bread.

Lou's Loans

Buy wet suit, tool kit, golf club, hat, nose glasses and hvjubs.
 Bob E. Pins Hair Salon
 Open tool kit.
 Use `xjsf dvuufston` bobby pin sign.

Use

switch (above sink).

Use `tubmf csfbe` in sink. Pick up bread crumbs.

Phone Company

Put on `ibu` and `optf hmbttft` (before entering). Enter Phone Company. Open counter door. Use computer terminal. Exit Phone Company. Take off `ibu` and `optf hmbttft`.

Bus

Use `lbapp`. Use cashcard in cashcard reader.

Zak's Living Room
 Use `npolfz xsfodi` on `qjqf`. Turn on



Zak McCracken and the Alien Mindbenders

Airport

Give cashcard to devotee (get book). Use reservations terminal (Seattle).

Airplane

Use **upjmf qbqfs** in **tjol** (in bathroom). Turn on **tjol**. Push call button (after flood). Go to front of passenger area. Pick up cushion (front seat). Pick up lighter. (Use same trick to distract stewardess.) Open microwave oven. Use **fhf** in microwave oven. Close microwave oven. Turn on microwave oven. (When **fhf** explodes, stewardess will remain in that area.) Open bin (until you find oxygen tank). Pick up oxygen tank.

Seattle

In National Forest

Pick up **usff csbodi**. Give peanuts to squirrel. Use **usff csbodi** with loose dirt.

Cave

Use **usff csbodi** on bird nest. (Feel around in dark with "What is" command to find this and the fire pit.) Use **usff csbodi** on fire pit. Use bird nest on fire pit. Use **mjhiufs** on nest and branch. Use **zfmmpx dsbzpo** on strange markings. Walk to ankh door. Stand on platform and face left. Use **sfnpuf dpouspm**. Pick up blue crystal. Fly to Miami.

Miami

Airport

Give **cppl** to bum (get whiskey). Use reservations terminal (San Francisco).

San Francisco

Drop Slot

Use **cmvf dsztubm** on drop slot (wait for Annie).

Annie's Room (Zak & Annie)

Give whiskey to Annie. Give **hpmg dmvc** to Annie. Give **xjsf dvuufst** to Annie. Switch to Annie. Pick up blotter. Pick up cashcard.

Bus and Airports (Annie)

Use **xjsf dvuufst** on bus. Use cashcard in cashcard reader. Fly to

Miami, then to Cairo, then to Kinshasa.

Kinshasa

Jungle Path

This map is randomized.

Hut (Annie)

Give **hpmg dmvc** to Shaman (far left hut). Watch dance and write down order of three men bouncing up and down; this sequence (3, 1, 2, 1, 3, 1, though it may be randomized) is the same as the Huge Door at the Face Chamber on Mars. Fly to Cairo, then to London.

London

(Annie)

Guard's House

Give **xjtlfz** to sentry. Pull switch. Use **xjsf dvuufst** on fence. Switch to Melissa.

Mars

Outside, near Shuttle Bug (Melissa)

Open door.

Inside Shuttle Bug

Pick up boom box. Pick up DAT. Open glove compartment. Pick up fuse. Pick up cashcards. Exit.

Outside, near Shuttle Bug (Melissa)

Give cashcard to Leslie.

Monolith (Melissa)

Use cashcard on Monolith (twice).

Entrance to Friendly Hostel (Melissa/Leslie)

Use token on metal plate. Pick up burnt fuse. Use fuse in fuse box. Switch to Leslie. Go to Melissa. Push left button (closes left door). Push right button (opens right door). Enter right door.

Inside Friendly Hostel (Leslie)

Pick up vinyl tape (on right locker). Pick up ladder. Pick up covers. Pick up broom alien. Open locker (right side). Pick up flashlight.

Entrance to Friendly Hostel (Leslie)

Push button (closes right door). Push button (opens left door).

Outside Friendly Hostel (Leslie)
Use **csppn bmjfo** on sand pile.

Huge Face and Door (Leslie/Melissa)

Use ladder on door. Push button (six times, according to dance sequence in Kinshasa). Pick up ladder. Enter Great Chamber.

Great Chamber (Leslie/Melissa) Enter first Massive Door.

Massive Door One, Outside (Leslie/Melissa)

Give vinyl tape to Melissa. Switch to Melissa. Use vinyl tape on **ebu**. Use **ebu** with **cpn cpy**. Turn on **cpn cpy (sfdpse)**. Switch to Leslie. Use **mbeefs** on pedestal. Pick up crystal sphere. Pick up **mbeefs**. Turn on flashlight. Enter N. door.

Massive Door One, Inside (Leslie)

Save. Follow map of Maze One to Switch Room. Turn on switch (right). Turn on switch (left). Take off helmet (**bgufs dpoejupot bsf opsnbm**). Follow map of Maze One to Map Room. Read strange markings (copy symbol to use in Sphinx in Egypt). Follow map of Maze One to Outside of Massive Door One. Exit (both) to Great Chamber. Enter Door Two.

Massive Door Two, Outside (Leslie/Melissa)

Give flashlight to Melissa. Switch to Melissa. Take off helmet. Turn on **cpn cpy (qmbz)**.

Massive Door Two, Inside (Melissa)

Pick up ankh (through far right door). Go to Leslie. Give ankh and flashlight to Leslie. Switch to Leslie. Exit to Great Chamber. Enter Massive Door Three.

Massive Door Three, Outside (Leslie)

Use **mbeefs** on pedestal. Pick up crystal sphere (through far right door). Pick up ladder.

Massive Door Three, Inside (Leslie) Use **boli** on panel. Pick up golden key.

Great Chamber (Leslie/Melissa)
Read strange markings on huge statue between doors two and three (copy symbol to use in Mexican Temple). Station both characters near exit of Great Chamber. Give golden key to Melissa (Leslie). Switch to Zak.

San Francisco

(Send Zak from Annie's Room to the Airport and fly to Mexico.)

Mexico City

Jungle Path

Tbwf. (Another randomized map, but this one leads to various entrances to the Temple. Keep trying until you emerge on the right side of the Temple, with the pyramid on the left side. Enter the Temple Entrance on the right side of the screen.)

In Mexican Temple: Maze Two

Save game. (Use the "what is" command to find torches in the dark, then use the lighter on the torch to illuminate each corridor. Follow the map of Maze Two into the Map Room. Pick up yellow crystal shard. Use **zfmmpxdsbzpo** on strange markings. Draw symbol from the Huge Statue in the Great Chamber in the Face on Mars (switch to Leslie and reread the marking on the Statue if necessary.) Follow the map out of the Temple. Save the game and keep taking turns through the Jungle until you reach the airport. Fly to London.

London

Stonehenge

Save game. Use **cmvf dsztubm** on altar stone. (After you awake, move the cursor all the way to the right, then quickly hit button **uxjdf** to leave before the alien arrives. After he leaves, return to Stonehenge.) Use **dsztubm tibse** (both parts) on altar stone. Fly to Katmandu.

Katmandu

Use **mjhiufs** on hay. Pick up flagpole. Give **cppl** to guard. (Visit Guru and learn how to use blue crystal.) Use **cmvf dsztubm** on

yak (after policeman returns to his jail). To Zak. (Wait for alien to toss you in stupidity machine).

San Francisco

Phone Company

Put on **ibu** and **optf hmbttft** (quickly, before alien leaves; this will save you lots of time otherwise spent waiting for the effects of the machine to wear off and for the alien to free you.) Open cabinet (to get artifacts seized by alien). Go upstairs. Open counter. Exit Phone Company. Remove **ibu** and **optf hmbttft**.

If unable to do the first two actions in time, do them after being released from machine and escorted outside. Then enter Phone Company, get the artifacts and exit. (Use either method when you're caught in the stupidity machine.) Fly to Miami. Save. Fly to Bermuda.

Bermuda

Plane and Mothership Cargo Bay
Wait (until caught by alien ship). Push button (inside space ship).

On the Mothership with The King

Read **Lott-O-Dictor** (write down random number). Give **hvjubs** to the King quickly, after reading meter. If successful, an alien shows you how to leave and you'll be beamed back to your room or you'll get tossed into the machine.

San Francisco

Lou's Loans

Buy Lotto (use **Lott-O-Dictor** number). Fly to Miami. Save. Fly to Bermuda.

Bermuda

On Plane Wait (until caught). Go to biplane (In Mothership). Use parachute (in air).

In Water (Zak/Dolphin)

Use **lbapp**. Use **cmvf dsztubm** on dolphin. Swim underwater.

Underwater (Dolphin)

Pick up seaweed (far right). Pick up glowing object. Swim to surface.

In Water (Zak/Dolphin)

Give glowing object to Zak. (After you get caught by alien, use hat and nose glasses to retrieve the artifacts.)

San Francisco

Lou's Loans

Win Lotto, \$10,000. Fly to Lima.

Lima

Jungle Path

This is one of the random mazes described in the introduction.

Feeder

Use **csfbe dsvnct** in bird feeder. Use **cmvf dsztubm** on bird.

Sky (Bird)

Fly to huge carvings. Fly to left eye. Pick up scroll. Fly to valley. (After you get caught by alien, retrieve your artifacts and fly return to this location.) Use **cmvf dsztubm** on bird. Give scroll to Zak. (You'll be thrown into stupidity machine. After you get out, grab your stuff and fly to London.)

London

Stonehenge (Zak/Annie)

Use **gmbhqpmf** with altar stone. Give scroll to Annie. Switch to Annie. Read scroll. Switch to Zak. Pick up yellow crystal. Fly to Cairo, then Kinshasa).

Kinshasa

Jungle Path (A random map.)

Hut

Give yellow crystal to shaman. Use yellow crystal (point to Lima).

Lima

Right Eye

Pick up candelabra. Use yellow crystal (point to Cairo).

Cairo

In Egyptian Pyramid, Teleport Room

Use **hmpxjoh pckfdu** on base. Use candelabra with **hmpxjoh pckfdu**. Pull lever. Leave pyramid (see map) and go to Sphinx **mfh** with strange markings.

Sphinx, Outside (Zak/Annie)
Use `zfmmpx dsbzo` on strange markings (draw symbol from Map Room in Maze One on Mars). Switch to Annie. Bring Annie to Zak (Outside Sphinx). Enter secret door (Annie).

Sphinx (Annie)
Follow map of Maze Three to the Map Room. Read hieroglyphics. Go to Zak. Switch to Zak. Bring Zak to Map Room.

Sphinx Map Room
Push button (according to sequence Annie just read). Use `zfmmpx dsbzo` on wallpaper map. Read strange markings (copy symbol to use inside Huge Face chamber). Use yellow crystal (`qpjou up gbd`). (You wind up in Teleport Room in Huge Face on Mars.)

Mars

Teleport Room, Mars
Use `zfmmpx dsbzo` on strange markings (draw symbol from Sphinx Map Room). Go to middle door. Go all the way to the right. Go left to exit. (See map of Maze One on Mars. Meet up with Melissa and Leslie.

Great Chamber (Zak/Melissa/Leslie)
Switch to Leslie. Put on helmet. Go to Monolith. Use cashcard on Monolith (twice, to get two tokens). Switch to Melissa. Put on helmet. Go to Monolith. Use cashcard on Monolith. Switch to Zak. Use `evdu ubqf` on fish bowl. Put on `ubqfe gjti cpxm`. Put on `xfu tvju`. Put on `pyzhfo ubol`. Go to Monolith. Get one token.

Monolith (Zak/Melissa/Leslie)
Use cashcard in Monolith (Zak). Send all three into Bug to use oxygen valve and fill their tanks, then return to the tram. Move all three close to the tram. Save. Use token in tram (all three people, and quickly).

Mars Pyramid, Outside (Zak/Melissa/Leslie)
Walk to pyramid. Use `csppn`

`bmjfo` on sand pile (Leslie). Use `cpccz qjo tjho` with key hole. Send all three inside.

Mars Pyramid, Inside (Zak/Melissa/Leslie)
Push sarcophagus feet (Leslie). Walk upstairs (Zak/Melissa). Move Leslie away from sarcophagus feet. Move Zak near containment device. Switch to Melissa. Use `hpmefo lfz` in box. Save. Push button. Switch to Zak. Pick up white crystal. (This will take several attempts, for you have little time. Verifiers report being unable to complete this task using keyboard controls on the IBM version, so you may want to finally break down and get a joystick or mouse.) Use yellow crystal (point to Egypt). Take off `ubqfe gjti cpxm`.

Mars Pyramid — The Coeds Blast off for Earth
Move Melissa to left side of stairs. Push sarcophagus feet (Leslie). Bring Melissa down and station her and Leslie outside near the tram. Use token in tram (Melissa and Leslie). Either one should use cashcard in Monolith to get a token, then enter the Hostel, use token on metal plate, enter room and pick up the fuse. Put Melissa and Leslie in Shuttle Bug. Use fuse in glove compartment. Close door. Use controls. (If low on air, use the oxygen valve before doing the above. Actually, it doesn't matter if the coeds die or get stuck on Mars, for the ending doesn't vary, even the epilogue that tells what happened to them.) Switch to Annie.

Cairo

Egyptian Pyramid, Teleport Room (Zak/Annie)
Bring Annie to Zak (across desert and into Pyramid Door). Pull lever (Annie). Switch to Zak. Use crystalabra with `cmvf dsztubm`. Use crystalabra with white crystal. Use crystalabra with yellow crystal. Turn on switch (right one). Switch to Annie. Turn on switch (left one).

Map Key: Zak McKracken and the Alien Mindbenders

- A: Phone bill, fish bowl, lamp, wallpaper map, cashcard, kazoo
- B: Seat cushion, remote control
- C: Yellow crayon, egg, bread crumbs
- D: Bread
- E: Wet suit, tool kit (wirecutters, duct tape, monkey wrench), golf club, hat, nose glasses, guitar
- F: Bobby pin sign
- G: Book
- H: Toilet paper, sink
- I: Lighter, oxygen tank
- J: Tree branch and squirrel
- K: Bird nest, Fire pit, strange markings
- L: Blue crystal
- M: Whiskey
- M1: Yellow crystal shard
- N: Sequence for opening Huge Door at the Face Chamber on Mars
- O: Boom box, DAT, fuse, Cashcards, oxygen valve
- P: Tokens
- Q: Burnt fuse
- R: Vinyl tape, ladder, broom alien, flashlight
- S: Sand pile
- T: Pedestal and crystal sphere
- U: Strange markings (copy symbol to use in Sphinx in Egypt)
- V: Ankh
- W: Pedestal, crystal sphere
- X: Golden key
- Y: Strange markings (copy symbol to use in Mexican Temple)
- Z: Yellow crystal shard, strange markings
- A1: Altar stone
- A2: Hay, flagpole, YAK
- A3: Guru (learn to use blue crystal)
- A4: Parachute
- A5: Winning Lotto number
- A6: Dolphin
- A7: Seaweed, glowing object
- A8: \$10,000
- A9: Bird feeder and bird

- B1: Scroll
- B2: Shaman (learn to use yellow crystal)
- B3: Candelbra
- B4: Strange markings
- B5: Hieroglyphics, strange markings (use inside Huge Face chamber)
- B6: Strange markings (draw symbol from Sphinx Map Room)
- B7: Tram
- B8: Key hole
- B9: Sarcophagus and sarcophagus feet
- C1: Containment device, box, white crystal

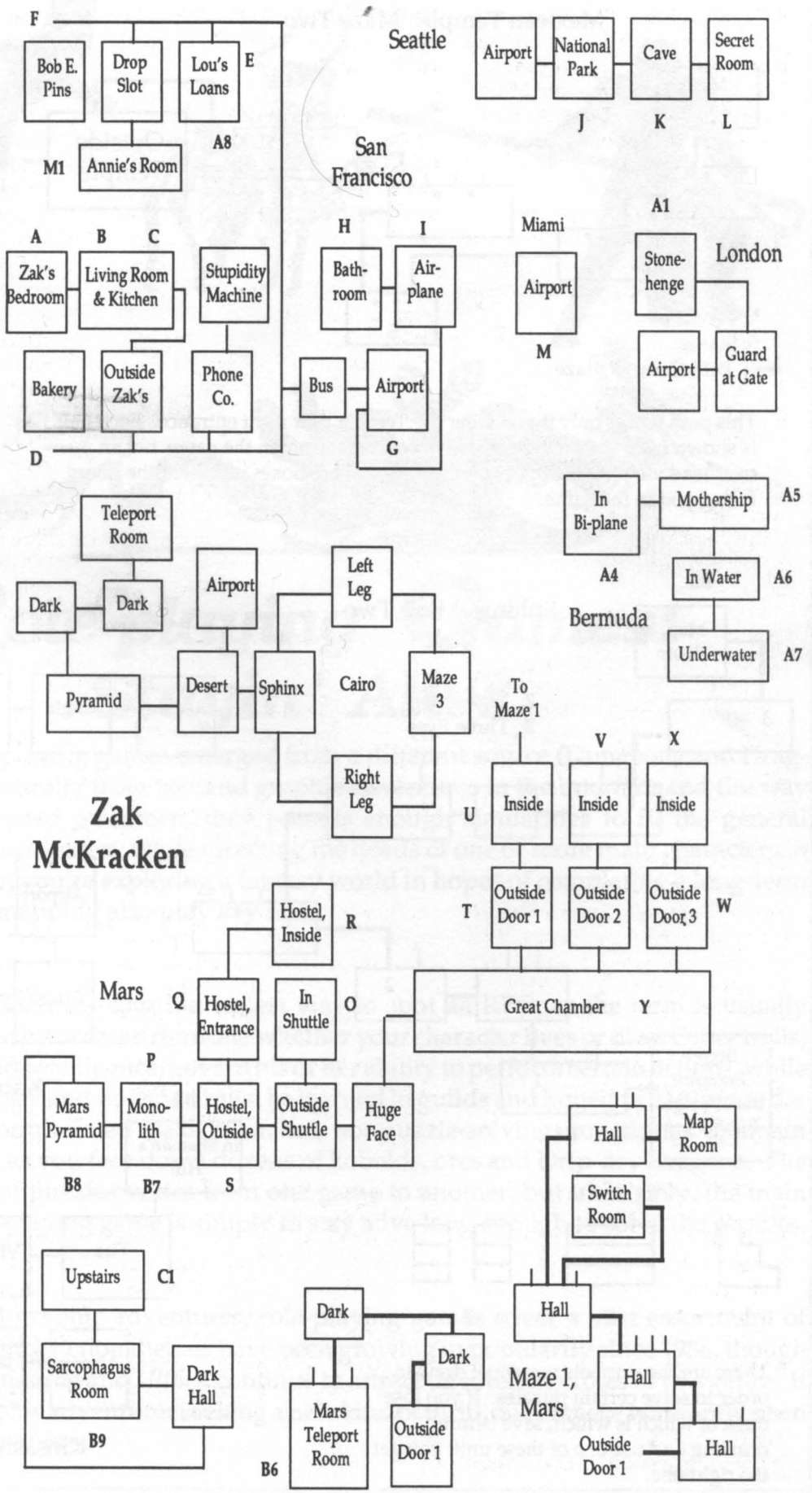

Mexican Temple: Maze Two

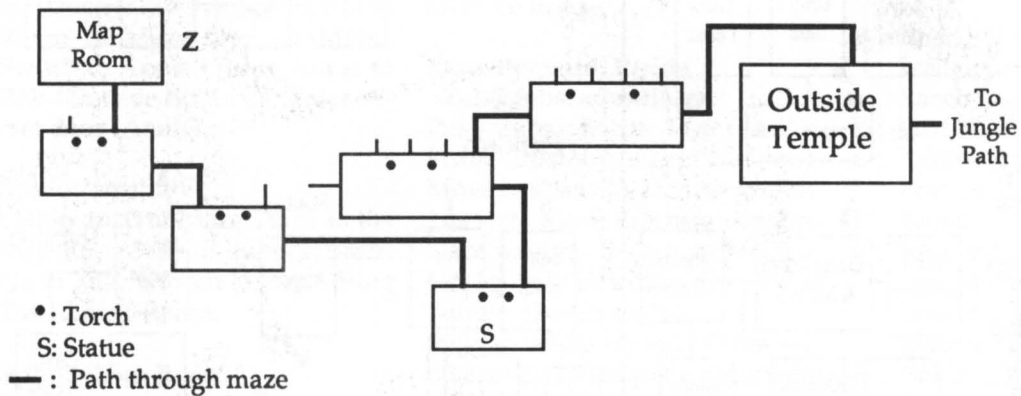

This path works only if you enter the Temple's far right entrance. Each hall is shown from the same perspective you see it from in the game, not an overhead view, so the doors on the tops of these boxes represent the doors facing you in the game.

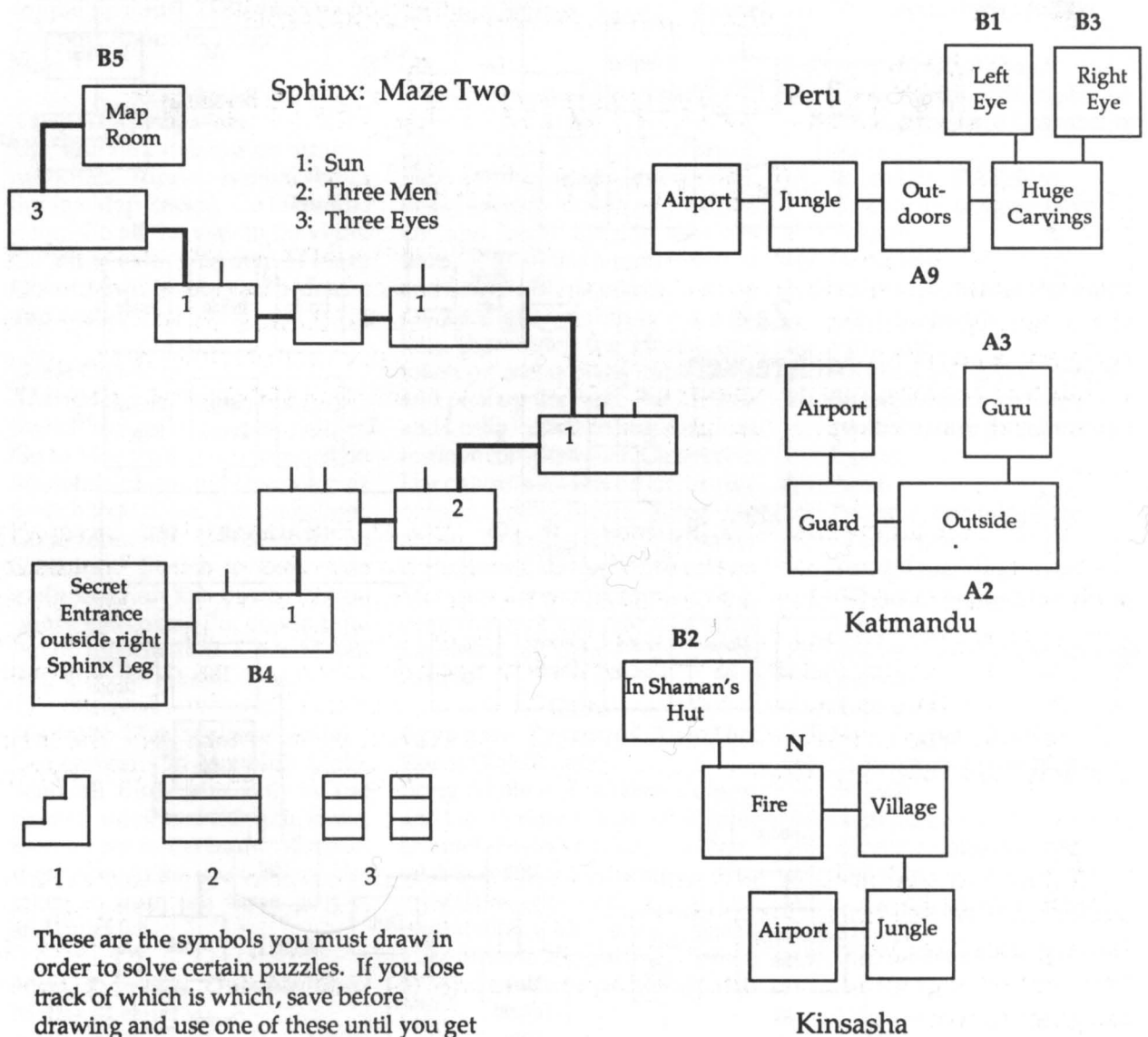

These are the symbols you must draw in order to solve certain puzzles. If you lose track of which is which, save before drawing and use one of these until you get the right one.



Role-playing Games: Stayin' Alive

Though role-playing games emerged from a different source (Dungeons and Dragons) and differ drastically from text and graphic adventures in the interface and the way the action is presented on-screen, they possess enough similarities to fit the general category of adventure games: while directing the deeds of one or more main characters in an interactive story, you're exploring a fantasy world in hopes of completing a long-term goal; puzzles and mapping also play key roles.

The main difference—and the easiest way to spot an RPG, as the term is usually abbreviated—is that hit points determine whether your character lives or dies. Other traits, such as Strength and Intelligence, govern his or her ability to perform certain actions, while skills such as Lockpick and Bowman must be learned in guilds and honed in battle in order to effectively perform related tasks. Combat, not puzzle-solving, constitutes the main activity in an RPG, as you face down dozens of kobolds, orcs and Drip-dry Dragons. The number and type of puzzles varies from one game to another, but ultimately, the main challenge of a role-playing game is simply to stay alive long enough to solve the puzzles.

Like text and graphic adventures, role-playing games cover a vast assortment of subject matter: science fiction themes have been growing in popularity since 1986, though fantasy tales like *Questron* and *Ultima* continue to attract devoted disciples of this genre. If you're a text or graphic adventurer seeking a new kind of thrill, one of these will surely open the gates to worlds of fun.

2400 A.D.

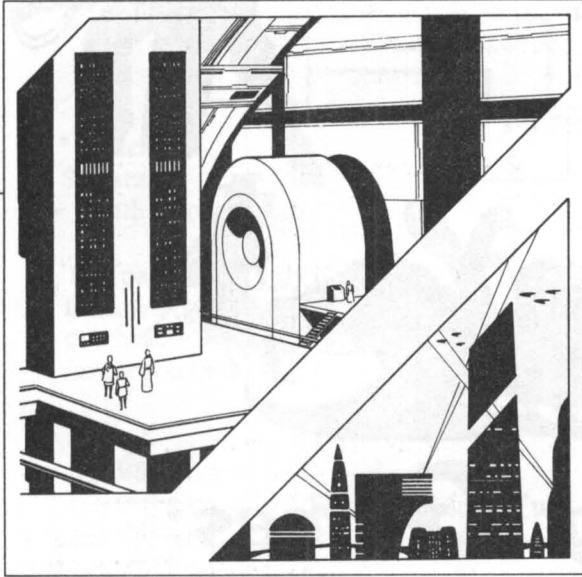

Set in a sprawling city shown from an aerial, *Ultima*-like perspective, this is a science fiction story without a space ship. After taking over the planet Nova Athens, the evil Tzorgian Empire has departed for new worlds to conquer, leaving a force of robots behind to monitor the human population and keep them in line. (If you don't check in with the Public Tracking Office every 2,000 moves, they'll go after you like mad dogs.) Your mission in this one-character game is to liberate the people of Metropolis by knocking out the central computer. There are two different ways to reach it, but you'll need equipment that can only be obtained by interacting with the people who live in the city. This too is done as in *Ultima*,

by typing in key words uttered by individuals when you first meet them, which elicits more statements and clues. The animated graphics and sound effects are also reminiscent of an *Ultima*, but here you're armed with lasers and other high-tech gear instead of swords and armor. A rewarding change of pace, *2400 A. D.* is especially recommended for those who enjoy the *Ultima* series but feel overwhelmed by the sheer size of the last few installments.

Type: Science Fiction Role-playing
Skill Level: Intermediate
Systems: Apple (64K), IBM (256K)
Company: Origin/Broderbund

The Solution

The Maps

These show only the Underground, since the game includes a map of the surface world. Grid coordinates of the maps' corners are marked for frame of reference. (These give the east/west direction first, then the north/south direction.) To determine current location, you can buy a Grid Reader in Jetways Transport Building (Building 40), which also sells Jetpacks. Scanners are useful for getting an aerial view of a large area. Access codes and certain words are coded, but not the numbers.

Character Creation & Development

Devote about 30 points each to Energy and Agility. IQ should be around 25, since it increases quickly. Spend the rest on Affinity. Energy can be boosted by running instead of walking; do so as much as possible, especially early in the game. You can also get an energy boost at (21) for 1,500 credits (it takes 2,000

ticks). Increase Agility by zapping a few robots. IQ goes up when you fix things; if you fail the first time, keep trying. An IQ boost can be had at (22) for 1,000 credits and 1,000 ticks. Affinity goes up when you talk to people.

Blasting robots is a tough, unreliable way to make a living, and the best way to get money is by finding caches of items, such as energy cells in one of System Storage's rooms. There are booster pills on the third level of the Social Rehab Center, to the right of the ladder that goes to your cell. Sell them to Tim (10) for 40 credits each, which nets 320 per trip.

Starting Out

Find Spider at Joe's Bar, who'll give you some things and tell you where to go. The password is nbefju. You can load your items by using a node (make sure there are stairs or a transport tube nearby so you can

escape any robots that appear), or with an energy cell. When you have enough money, buy a Directive Override (30), which is useful against high-level robots.

There are two good ways to reach the Underground early in the game. Go to the southwest corner office in the Administration Office and look behind the bookcase for a tube that goes there. Or you can enter through the apartments with your passcard.

Escape from Jail

When your energy reaches 10, push the bed away from the wall and step through the passage. Climb down the stairs until you emerge in the Underground (14). Walk west to the farthest ladder (1) and climb it. From Administration, go to the ground floor of the Social Rehab Center. In the right storage room is an open container with the items confiscated when the robots put you in jail.

Improving your Arsenal

The Field Disperser protects you from almost all damage from robots and allows you to walk through force fields. You won't need passcards (the Plasma Rifle will blast doors open), ZAKs (blast the robots too), or energy cells (nodes are everywhere, and you don't have worry about the 'bots now).

To get the Field Disperser, go to the D Building of Megatech and take the transport up. Break down the door to the south. There are five cabinets along the right wall in the next room. The middle one has the Field Disperser blueprints. Take them to Les in Megatech Building F and say `cmvfqsjout` and he'll build one for 3,500 credits. To get a Plasma Rifle, you must constantly buy weapons from Wes throughout the game. Eventually he will offer a broken Plasma Rifle. Hugo is the only one who can fix it, but you'll need more parts. Find the Multiplier Tube in the trash behind Gilbert's Electronics. Buy a Microstat from Larry's Electronics. Say `sfhvmbups` to Gilbert. He'll trade an Energy Regulator for the Microstat. Buy an HV Oscillator from Larry and take these three items and 550 credits to Hugo. Many more weapons and devices are sold by Device Vendors at (3) and (30) in the Underground complex. Try out a variety of them to see which ones work best for you.

The Transporter Guidance Device

If Energy and IQ aren't 99 by now, get boosts as described above before proceeding. The Transporter Guidance Device (TGD) is in the Underground. Go to South Station and walk along the tracks to the west until you find a locked door. Break it open and take the ladder down (11) to (25). Go south through the force fields and dismantle the Protectors. Break down the locked door to the east. Break down the third door on the north wall. The TGD (38) is on the

third pipe to the left (121, 164).

Combat

When a robot is low on energy it will stop firing and head for the nearest energy node. If you can bar its way to the node, it will run out of energy. You can destroy one robot in a doorway and dupe those behind it into blasting at the walls until they run out of energy. Better yet, the Directive Override lets you take over one robot while the others shoot at the walls, and he will shoot at the others until out of energy.

Another trick is to stand near a stairway or transport tube and shoot at passing robots. If the nearest ones are too strong, or if more show up, go to the tube or stairs and rest until your energy is restored; then return. The surviving robots will have forgotten about you, and you can search the dead ones for credits.

Learning the Codes

The access codes for the terminals are `BDDUSN`, followed by the number of the level the terminal is underground minus two. The transporter code is `MFUTHP`. The destination code is a two-digit number ranging from 00 to 22. (See chart for transporter locations and destinations.)

Codes needed to deactivate the Main Computer Console are Underground. Go to Marion's office at Administration, break down the doors and enter the tube. Break down the locked door to the east and go down the next tube. Terminal 0 (19) is at the end of the corridor beyond the pipes. Access code is `BDDUSN0` (the last figure is a zero). Say code. Go down the tube. You're now on a small island surrounded by slidewalks. The easiest path to Terminal 1 (36) here is shown on the map (the slidewalk won't take you directly there, so you've got to do some maneuvering on your own). Access code for Terminal 1 is `BDDUSN1`. Say code. Climb over the terminal and enter the transporter: destination code is 06. The path to (37) the Terminal 2 (the final one) is shown on the map. To reach it you'll have to push the chests around, being careful not to trap yourself. Terminal 2 access code is `BDDUSN2`. Say code.

Two Ways to the Main Computer Console The Secret Tunnel

This route, the tunnel in the City Dump, requires the Transporter Guidance Device; a Scanner is helpful. From the Dump's entrance, take the middle path until you reach the last trail to the north. Take eight rights, two lefts, one right and one left (use the Scanner if you get lost). Climb down the stairs.

Transporter Maze

Break down the locked door at the west end of the passage. Enter the transporter in the first room you

see (134, 063): destination code is 18. Enter transporter. Code 09. Enter transporter. Code 12. Enter transporter. Code 15. Climb down stairs (18 to 31).

Binary Maze

The route through the glidewalks is shown on the map. Enter any transporter; no destination code is needed. (But without the Guidance Device, you can't go any further.) Follow the corridor past the doors. Turn left at the intersection. Break down the locked doors to the west. Beware of the Protectors. Follow the passage beyond the door. Work your way past the robots to the hidden stairs (28) to the Pipe Works. Go up.

Pipe Works

Climb over the pipes to the stairs (26).

T. A. C.

Keep climbing the stairs until you reach the fifth level (see Main Computer Console section below for rest of solution).

Tzorg Authority Complex

The other route to the Computer is through this complex. It is shorter but requires a Jetpack (sold in Building 40 on the surface).

T. A. C., Level 1

The transport tube is in the center of the complex,

guarded by two tanks. Break down the locked doors to reach the middle of this level.

T. A. C., Level 2

You emerge from the transport tube at 112, 131. Go west through the doors, demolishing the robots. Many Protectors will bar your passage through the force fields. Just Override them. The transport tube is to the northwest.

T. A. C., Level 3

Walk to the slidewalk and use the Jetpack to cross it. Take the ladder up.

T. A. C., Level 4

You should be in a small passage with no exits. Take the ladder up.

T. A. C., Level 5

You're now in the lower left corner of the fifth level. To the north, beyond the force fields, is the Main Computer Console.

Main Computer Console

Talk to console. Primary Deactivation Code: DIMPCV. Secondary Deactivation Code: QFSBCS. Tertiary Deactivation Code: FEEPOF.

Transporter Locations and Destination Codes

Access Code: MFUTHP

<u>Code #</u>	<u>Location</u>	<u>Destination Codes</u>
00	132, 115, LO	01; 02; 03; 04
01	226, 128, LO	00; 02; 03; 04
02	110, 211, LO	00; 01; 03; 04
03	015, 112, LO	00; 01; 02; 04
04	108, 048, LO	00; 01; 02; 03
05	012, 125, B3	06
06	026, 117, B4	05
07	133, 100, B1	00; 01; 02; 03; 04
08	141, 063, B1	10; 11; 13; 14; 16; 17
09	148, 063, B1	08; 10; 11; 12; 13; 14; 16; 17
10	155, 063, B1	08; 11; 13; 14; 16; 17
11	132, 070, B1	08; 10; 13; 14; 16; 17
12	139, 070, B1	08; 10; 11; 13; 14; 15; 16; 17
13	146, 070, B1	08; 10; 11; 14; 16; 17
14	153, 070, B1	08; 10; 11; 13; 16; 17
15	130, 077, B1	08; 10; 11; 13; 14; 16; 17
16	137, 077, B1	08; 10; 11; 13; 14; 17
17	144, 077, B1	08; 10; 11; 13; 14; 16
18	151, 077, B1	08; 09; 10; 11; 13; 14; 16; 17
19	156, 095, B2	To 152, 100, B2 with TGD, otherwise 20, 21 or 22
20	148, 095, B2	To 152, 100, B2 with TGD, otherwise 19, 21 or 22
21	148, 098, B2	To 152, 100, B2 with TGD, otherwise 19, 20 or 22
22	156, 098, B2	To 152, 100, B2 with TGD, otherwise 19, 20 or 21

Map Key: 2400 A. D.

- N: Energy node
- T: Transporter
- X: Transport Tube exit
- ^: Transport Tube or Stairs Up
- v: Transport Tube or Stairs Up
- Solid line through hall: locked door

- 1: Ladder up to Administration
- 2: Ladder down to maze of boost labs
- 3: Device Vendor
- 4: Ladder down to middle of boost labs
- 5: Ladder down to middle of boost labs
- 6: Ladder up to Larry's Electronics
- 7: Energy cell dealer (buy/sell)
- 8: Ladder down to pipe factory
- 9: Ladder down to near Wes
- 10: Tim (say buy or sell to sell things)
- 11: Ladder down to area with Transporter Guidance Device
- 12: Ladder up to Novue Apartments, down to level 2 of Underground
- 13: Jeff (sells passcards and ZACs)
- 14: Ladder down to pipe factory, up to Social Rehab Center
- 15: Ladder up to City Dump
- 16: Ladder down to Binary Maze
- 17: Ladder up to (15)
- 18: Ladder up to (9)
- 19: Terminal 0
- 20: Ladder up to (3)
- 21: Energy boost
- 22: IQ boost
- 23: Ladder up to (5)
- 24: Ladder up to (6)
- 25: Ladder up to (12)
- 26: Ladder up to T. A. C. secret entrance
- 27: Ladder down to (30)
- 28: Ladder up to Pipe Works
- 29: Ladder up to (18)
- 30: Device Vendor
- 31: Ladder up to (10)
- 32: Wes (sells weapons)
- 33: Infinite cache of energy cells
- 34: Pinkie
- 35: Ladder up to (13)
- 36: Terminal 1
- 37: Terminal 2
- 38: Transporter Guidance Device
- 39: Main Computer Console

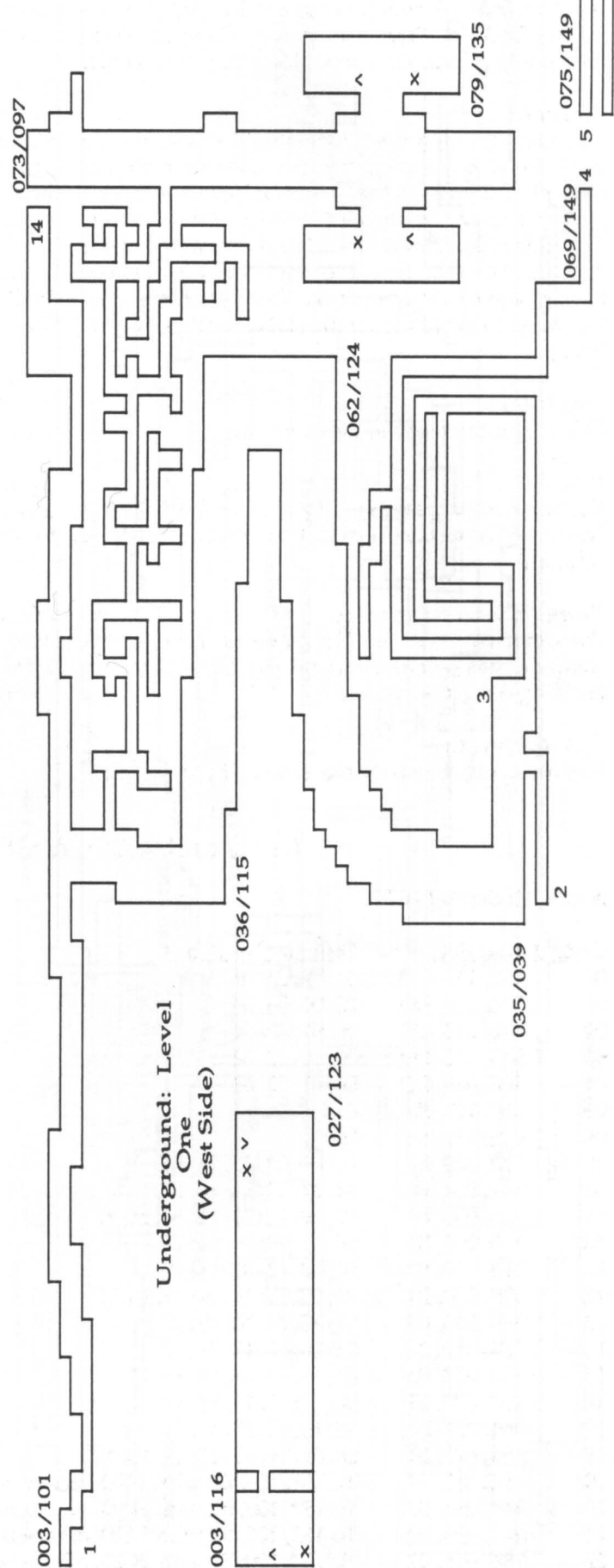

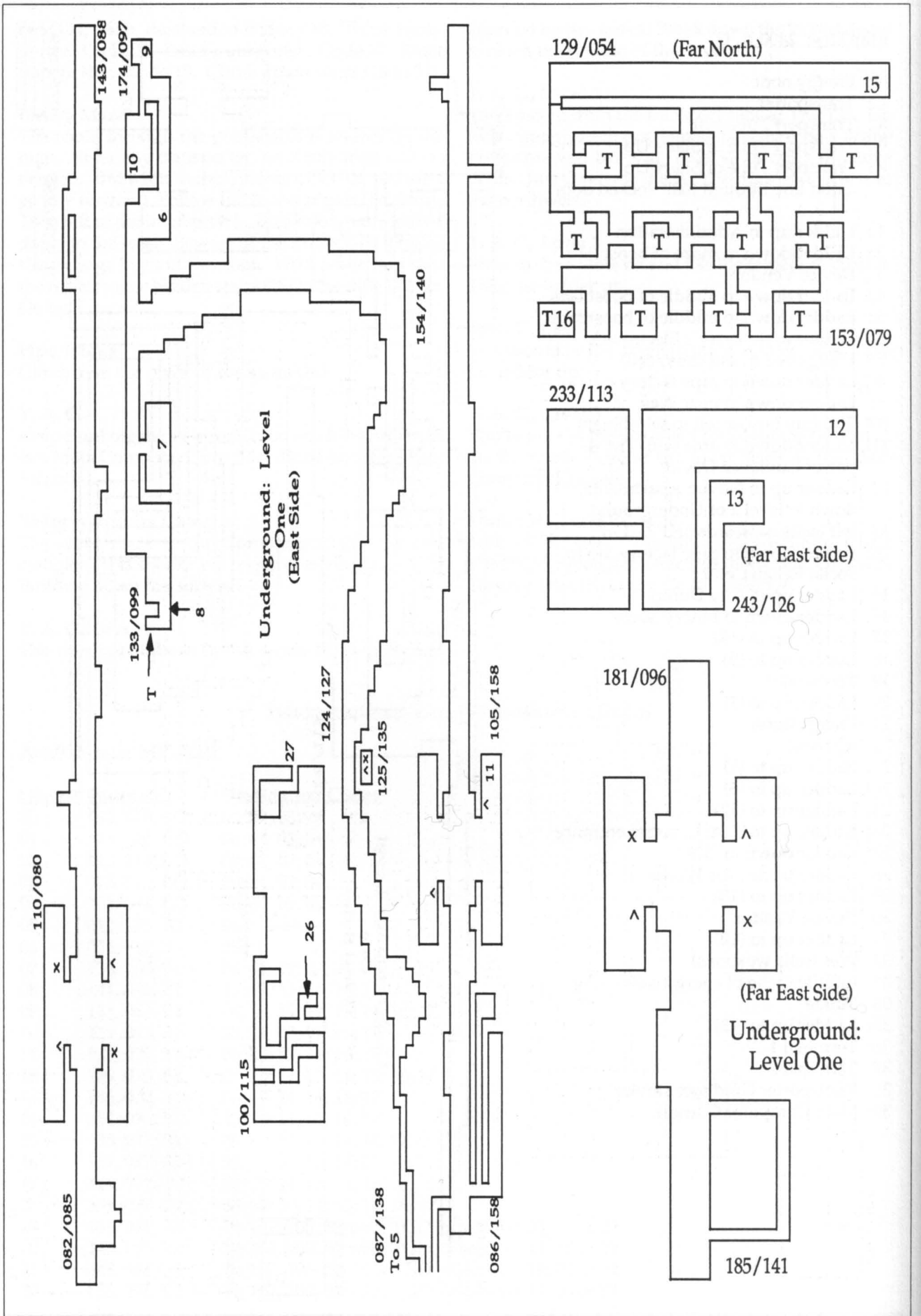

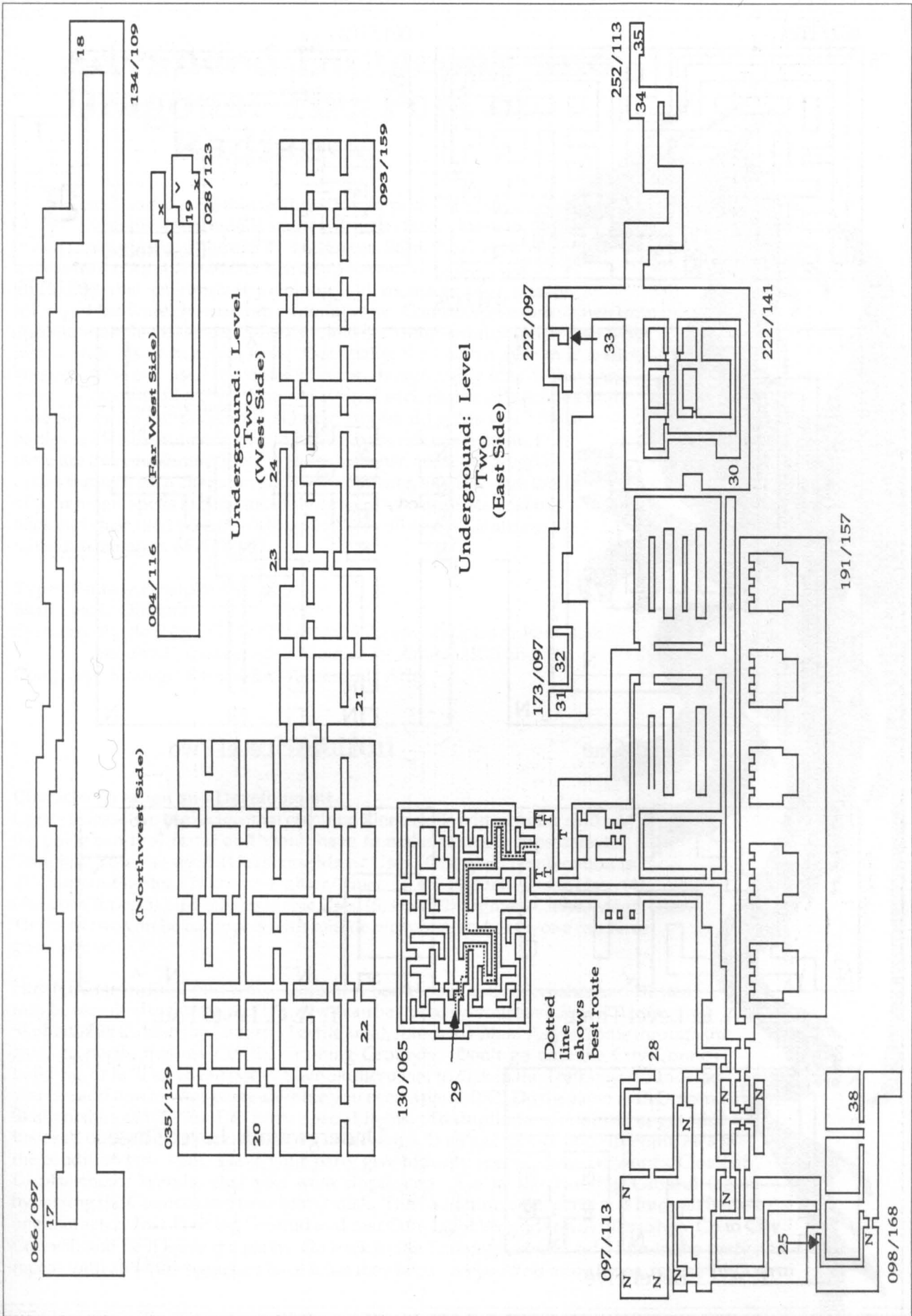

002/112

36

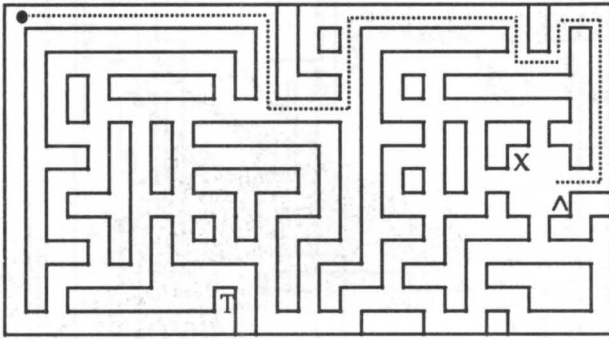

001/112

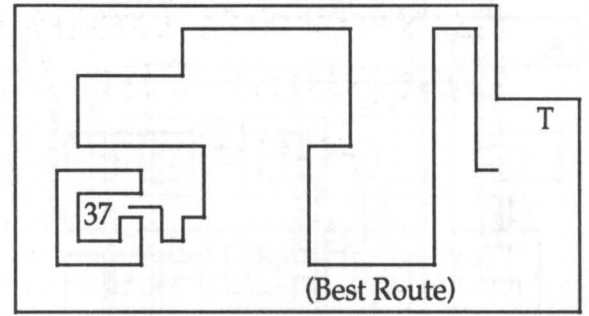

031/126

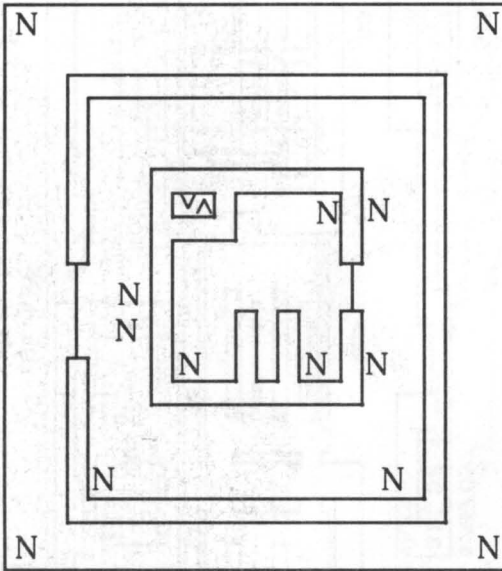

T. A. C. Level One

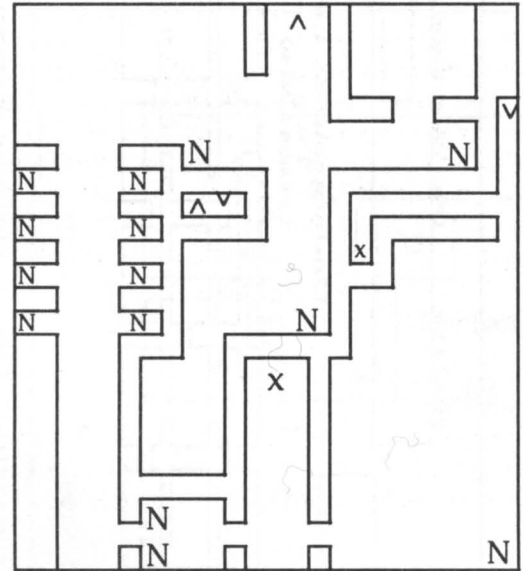

T. A. C. Level Two

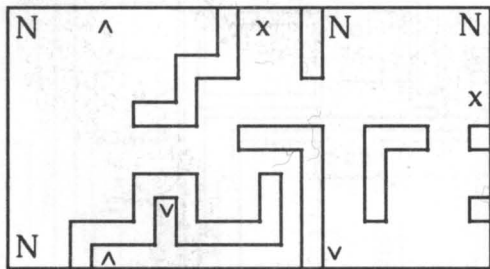

T. A. C. Level Three

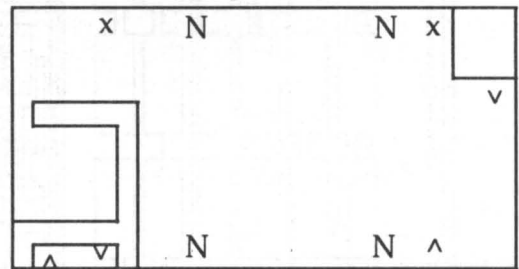

T. A. C. Level Four

39

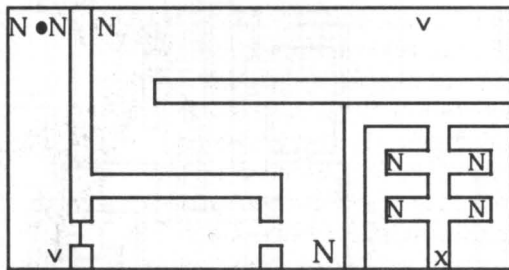

T. A. C. Level Five

Underground: Level Three

Advanced Dungeons and Dragons: The Pool of Radiance

Based on the game that inspired all computer role-playing games, *Pool* entails a series of quests that culminate in a confrontation with the evil Tyranthraxus. Set in the Forgotten Realms, it's a six-character game (up to two NPCs can also tag along) that emphasizes mapping and monsters over puzzle-solving. Mazes are shown from an aerial view. Combat scenes are shown from an oblique angle that lends a 3-D effect, and each semi-animated character is depicted with his or her own icon. Essentially, the combat system is a slick version of the one used in *Wizard's Crown*, though many fans of that game were disappointed by *Pool*. You can control each character's actions individually, or let the program's "Quick" option do it for you. Since battles can last an hour or more, this feature sounds convenient. But there are two problems: "Quick" isn't any faster, since the program cycles through each character and every monster, and it wastes lots of your magic spells in combat. Only gamers who are ecstatic about hack and slash (and who don't like puzzles) will enjoy this almost *too* faithful adaptation of *A D & D*.

Type: Fantasy Role-playing

Skill Level: Difficult

Systems: Apple (64K), C 64/128, IBM (256K, two floppies or hard disk required), (conversions planned for Amiga, IIGS and ST)

Company: Strategic Simulations/Electronic Arts

The Solution

Character Creation and Development

Create at least two characters that combine Cleric skills with another skill so the party can heal faster and won't have to make as many trips back to Temples. You also need at least one Magic User. One good combination is: (1) Human-Fighter, (2) Dwarf-Fighter/Thief, (3) Elf-Fighter/Magic User, (4) Human-Cleric, (5) Elf-Fighter/Magic User, (6) Half-Elf-Fighter/Cleric/Magic User. The back two can be equipped with missile weapons, and everyone can have good armor.

Hire NPCs from the Guild when necessary. Some, such as Skullcrusher and Dirtten, may be recruited in the mazes. These two can be stored on your save disk. After locating Skullcrusher (2, 15 in the Cadorna Textile area), return to Phlan. As you come through the gate, go north, then east to the Training Grounds. Don't go past the City Council building, or he'll leave the party. Save Skullcrusher to disk in the Training Grounds, so you can add him to your party anytime you need a new NPC. Do the same with Dirtten. Skullcrusher can be used to carry special items. To duplicate special items, get him knocked out in battle (bandage him if he's dying). If he's at zero or one Hit Point, he's in the condition you want. Have your party give him any special items (+Swords, Cloak of Displacement, Wands, etc.) you want duplicated. Go to the Training Ground (again bypassing the Council) and save him to disk. Then add him to the party and trade all items to one character. Exit Training Ground and cast Cure Light Wounds on Skullcrusher. Go to City Council, and he'll leave the party. Go back to the Training Ground, add him to the party and repeat until all your characters have what they need. As you find more items, repeat this to arm

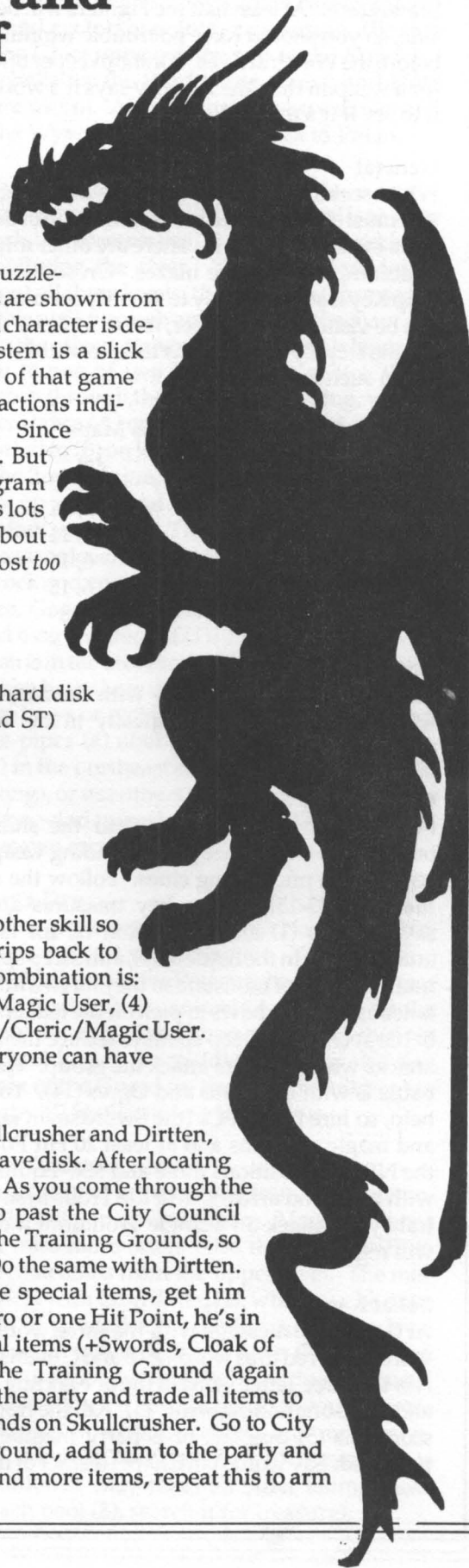

everyone with special armor and magic gear. For easy experience points, hang out in a tavern until a brawl starts. At least half the Fighters will be on your side, so you should have no trouble winning. Leave before the Watch arrives. If a shopkeeper offers more for a weapon than the Armory says it's worth, equip it to see if it's magical.

General

While seeking treasure, weapons and magic items, you must clear each maze of monsters in order to earn extra experience points. There are other mini-quests to accomplish in some mazes. On some maps, the Map Key is set up mainly to identify certain areas that can be visited in any order, not to indicate that these are the step-by-step actions to follow (this is pointed out in such instances).

Key Locations on Wilderness Maps

Phlan	12, 27
Zhentil Keep Outpost	3, 33
Buccaneers' Base	12, 31
Nomad Camp	12, 11
Yarash's Pyramid	6, 16
Kobold and Wyvern Caves	6, 15
Lizard Men's Keep	11, 8

Combat

Combat tactics vary widely with the major battles, which are discussed specifically in the following sections.

Clearing The Slums

Here your main goal is to clear the slums while building up experience points, finding weapons and scrolls, and uncovering clues. Follow the map and Map Key (3-15) for the key treasures and items, saving Ohlo (1) and the potion (2) for last (don't attack Ohlo). In the battle at (9), aim Sleep spells at the multiple lines of monsters so they hit two lines simultaneously, using bows to pick off the leaders. For the battle at (11), use Sleep spells to reduce their archers' attacks while Fighters attack the group. The hardest battle is with the Trolls and Ogres (14). You'll need help, so hire two NPCs (the Swordsman and Hero), and magic weapons and at least 20 Hit Points. Put the NPCs in positions three and six. Equip Fighters with bows and arrows. Kill the Trolls first. Concentrate your attack on a single Troll until it dies, or it will regenerate.

Sokal Keep

At (1), get the message with the three words (which will be referred to as words A, B and C in this solution: A is the three-letter word, B the one ending with "D" and C the one ending with "I"). Kill the frogs (2) and scorpions (5) quickly, or a party member will be poisoned. Say word A in Chapel (center of maze) and

Barracks (4) to get messages. Then proceed to the battle at (3), say word A and tell the truth to Ferran and get the magic weapons (8). To avoid battles with Skeletons and Zombies (6), say word C before visiting the Chapel and word B after talking to Ferran (or you can fight them if you want points). Take two NPCs for the main battle at (3). Give bows to all Fighters, position your team in an "L" formation and let the monsters come to you, then pick off the Archers and Leaders with arrows when they get close to your lines. Use Sleep and Hold Person. (Another tactic: when combat commences, retreat toward the north door, firing arrows as you go; the monsters will follow and be easy to pick off.)

Kuto's Well and the Catacombs: Norris the Grey

The best way to tackle this one is by going directly to the Well (2) and defeating Norris the Gray in the Catacombs (4), which enables you to rest and recuperate in the Catacombs or Well while clearing out the upper area. (If Norris is not at (4), he'll be somewhere in the north half of the Catacombs.) Don't forget his treasure (5), and the Hag's (1).

Mantor's Library: Looking for Books

Use the Knock spell to enter. Clear out the monsters, staying in Search mode and moving around until you find them. Follow the Map Key to get the five books. When attacked by the Spectre on the way out, use magic weapons.

Podol Plaza

This is a good place to build up experience points. Stay in Search mode and the monsters will find you. There are two ways to complete this one. If you enter while not on the mission, you can just clear the block of monsters. If on the mission, choose the "disguise monster" option at (1) and rush to (2) to defeat the Buccaneer. Use Knock to enter doors (3) to rest and heal in the Temple. Avoid the Shrine at (4) if disguised (if not, fight the battle). Then get close to the Auction Block (5) to pick up information and return to the Council.

Cadorna's Textile House: Quest for the Family Treasure

Don't enter this one unless on the mission to find Skullcrusher and the treasure. Then follow the Map Key (1-9). After finding the main Cadorna treasure, do not take or open it. Instead, take Skullcrusher to the Guild and save him (see tips on Character Development). Then return for the treasure, which includes useful weapons. Don't open it—take it to Restal, who will fix the seal so Cadorna won't know it's been opened. In the battle at (6), eliminate the Guards quickly, using Hold Person. In the battle at (9), Sleep the Archers if possible, eliminate the Ogre King early.

Kovel Mansion

Here your main goal is to clear out the Thieves, but you can also pick up information, artifacts, etc. Just follow the Map Key, staying alert for traps and ambushes.

Wealthy Section

Your goal is to recover artifacts while clearing the temple. After the Bishop lets Dirtten join the party, save him at the Guild (see Character Development section above) before setting out. Follow the Map Key. After random encounters, keep the holy symbols you find until everyone has one.

Temple of Bane

Everyone needs holy symbols (see Wealthy Section) to enter. Follow the Map Key to find certain artifacts and to destroy Mace. There are lots of treasures here, so much that you'll have to make several trips if already loaded down. If you decide to destroy the altar (5), use Hold Person and Sleep, not Fireball (unless really desperate).

The Valhingen Graveyard

Again your goal is simply to clear the area, filled with undead creatures. Follow the Map Key, destroying the Vampire before seeking treasures. When your party has been reduced a level or more or is low on hit points, return to the Mansion area to rest and save the game. When fighting Spectres, close quickly and try to kill them all in the first two rounds. Against Zombies, Turn, fight and Turn again (if you have two Clerics); then leave and rest. Do not rest in the Graveyard, however, unless you're fond of Ghouls. And don't let any evil Magicians join the group.

Kobold and Wyvern Caves

Here you've got to slay the Kobold King and get the Efereeti bottle. (There's also a big treasure.) Follow the Map Key. Save up potions for the major battle (7), which consists of three waves. In the first, use Fireball and knock out the Bowmen first, then use wands and swords on the Trolls before finishing off the Kobolds. In the second wave, Boars must be "overkilled" or they bounce up after the first kill. Use wands to weaken enemy Fighters in the third wave. Between battles, use points to heal. Do not end battle when asked to do so. Instead, heal the most seriously wounded characters, then end battle, as next wave starts immediately (with no chance to encamp). When all three waves are done, encamp, heal and save. After slaying the Kobold King (9), get the main treasure (10) and save the game, or the main battle will restart next time you hit that area. Finally, get the Efreeti bottle (tell the truth) at (11).

Nomads

You have to "deal with" the Nomads in the Wilderness. No map is furnished here, since this is a small

area in which you can easily find your way. Talk Nice to the Nomads and you'll fight three battles against Kobolds and get lots of points and treasure. (Be sure to help the Chief wipe out the rest of the Kobolds.) Save Fireballs for the third battle. Sleep and Hold Person are useful. After the battle, you can rest and heal in the Wyvern Cave or head back to Phlan.

The Pyramid on Sorcerer's Island

This is on the river north of Phlan. The goal is to wipe out Yarash the sorcerer and destroy the machinery that is polluting the river. Teleporters are found throughout all three levels, though only those necessary for this walkthrough are shown on the map. (To figure out the others, remember that some teleporters send you to one of two locations; to switch these, throw a rock through them.) Upon entering, walk to the first entrance (A) on the right and enter it. You'll be teleported to (B) on level two. Follow the hall, turn right at the first junction, and go to the end of the hall (C). Pick up a rock and throw it through the teleporter before you enter. Then you get teleported to (D) on the same level. Follow the hall to the end to (E), throw a rock and enter the transporter to reach (F) on level three. Go to (G) and teleport to (H), then decode password over the door at (1). Help the Lizard Men (2). Yarash is in the other room (3). Kill him by casting Silence, then have three characters rush him while the others use bows or cast Bless, Curse or Hold Person. Break the pipes (4) after the battle. Use the transporter (5) in the northeast corner to exit the pyramid (Blue setting), or use others to teleport to the treasure first. (If you wind up on level one, find the Priest (P), who helps you escape.)

Buccaneer's Den

Here you've got to rescue the boy. No map is provided, since this is a simple layout. You can camp outside the building in the lower right corner. To free the boy, first release the animals in the pen on the right side of the map. Then liberate the lad, who is in the small building in the middle. You can also slay the Captain of the Guard (in the bottom building) to get +3 Plate, +2 Skulls and +4 Longbows.

Lizard Men's Catacombs

An Anti-magic spell prevents you from using memorized spells, but you can read them. Magic weapons work but miss more often. Use the stairs at (B) to reach the catacombs from the upper level. The mission is to deal with LizardMen (2), which can be done two ways. If you talked to the LizardMen on level three of Yarash's Pyramid and have the password (tbwjps), let one of your team fight the duel proposed by the Lizard's chief; if he wins the duel, you can complete this mission without slaying any more monsters here. Method 2 for dealing with LizardMen is more traditional: slay them all (after killing those around each pool (3), search it for treasure).

Zhentil Keep Outpost

This maze is pretty much automated in the early stages, when the Commandant takes you to dinner. You can pry information from him. Post a watch after dinner, because the guards will attack. All you can do is head for the gate and fight your way out.

Stojanow Gate

Your goal is to break through the gate, the only way into Valjevo Castle. The idea is to use disguises to get past the Bugbears so you can attack the Towers by surprise, then return to wipe out the Bugbears. Once inside, get a wagon from the vendor (1). Then you can get past the Bugbears and enter the Southern Gate at (2). (If they won't let you, break it down. This applies to the Northern Gate too.) Then tackle the Towers (3, 4). The key to the Tower battles is to use the Advance command to get as close as possible to the enemy groups. An alarm goes off once you've attacked a Tower, so you must eliminate both Towers and Bugbears (at Gate) quickly (or hide in a Tower until the alarm stops).

Valjevo Castle

Enter via Stojanow Gate. If you set off the alarm in here, hide until it stops. Get disguises by talking Nice to women at (a). You don't have to visit all the places on the perimeter, except to learn the passwords. Enter Level One of the Tower by Gate (o) or (f), either walking through the maze or using the random teleports until you reach (o)—the preferable entry point because you can go straight to wipe out the False Tyranthraxus at (1) and take the stairs up (2), avoiding the Medusa (3). On Level Two, avoid the trap door (4) and be Nice to the messenger at (5). Slay Genheeris (6) and get the Wand. The main battle is at (7). Use Dust Disappearance, move to the enemy Fighters' flank and hit them with the Lightning Wand. Both Clerics should use Hold Person until there are few enemies left. (Once held, use bows or swords to kill, since Magic Wands won't kill.) Once all are dead, continue battle, use potions and spells to heal, get Rings (+3) and go for the Dragon. Kill your NPC (if you have one), or he teams up with the Dragon. Magic won't work on Tyranthraxus, so keep hitting until he's dead.

Map Key: The Pool of Radiance

Thick dotted lines on most maps indicate Illusionary Walls. Thin ones are walls of rubble.

Slums

A: To Phlan

B/C: To Kuto's Well

- 1 : Ohlo the Magician, who wants potion
- 2 : Ohlo's potion
- 3 : Orcs (scrolls)
- 4 : Goblin Training Room (treasure)
- 5 : Kobolds (treasure is Bracers)
- 6 : Orcs (treasure)
- 7 : Hobgoblins (treasure)
- 8 : Treasure Room
- 9 : Massive Orc attack
- 10: More Monsters
- 11: Goblin Guards (difficult battle)
- 12: Treasure
- 13: Stable (treasure)
- 14: Ogres & Trolls (hardest battle)
- 15: Fortune Teller (don't attack her)

Sokal Keep

- 1 : Skeleton with three words (see solution)
- 2 : Poison Frogs (treasure)
- 3 : Massive Orc/Hobgoblin battle
- 4 : Say A, from (1), to get treasure & Journal entry
- 5 : Giant Scorpions.
- 6 : Say C to patrol before entering chapel; say B on the way out
- 7 : Ferran Martinez (say A, tell truth)
- 8 : Magic Weapons

Kuto's Well

A: To Slums

B: To Podol Plaza

C: To Library

- 1 : Hag (treasure)
- 2 : Well (enter to reach Catacombs)

Catacombs under Kuto's Wells

- 3 : To/from Well
- 4 : Battle with Norris the Gray
- 5 : Treasure
- 6 : Monster

Mantor's Library

Use search mode until you find books indicated in the areas below.

- 1 : History books (three)
- 2 : Philosophy books (two)
- 3 : Kobolds (map of Textile House)
- 4 : Scribe's Chambers (treasure)
More treasure

Podol Plaza

- A: To Well
- B: To Gate
- C: To Outside of City
- D: To Textile House
- 1: Choice of sneaking in, walking through, entering disguised (do so if on mission)
- 2: The Pit (Buccaneer, Magic Items)
- 3: Temple (rest area; use Knock to enter)
- 4: Small Shrine of Bane (don't enter if on mission and party is disguised, otherwise fight battle)
- 5: Auction Block (If disguised and on mission, get close to block for information.)

Cadorna Textile House

- A: To Plaza
- B: To Outside of City
- C: To Library
- 1: Journal Entry 11
- 2: To Thief's Guild (only a Thief on this mission can enter; Restal will lead you to well at 3; see him after you get the treasure here, he will duplicate lock on treasure if you didn't break the seal).
- 3: The Well (see 2)
- 4: "Skullcrusher was here."
- 5: Baby Hobgoblins flee.
- 6: Guards (search for key needed to free Skullcrusher).
- 7: Skullcrusher in chains; will join party if freed. Journal Entry 47 tells of secret door to southeast.
- 8: Secret door (if Skullcrusher is in party)
- 9: Major battle and treasure (see 2)

Kovel Mansion

- Some doors must be bashed in order to open them.
- A: To Outside and Graveyard
 - B: To Wealthy Area
 - C: To Boat
 - T: Traps
 - 1: Thief backstabs party member and leaves.
 - 2: Two Thieves run and split at 3. Follow the one to 4, go back and follow other to 5 and defeat the Guildmaster.

3/4: See 2.

- 5: Major battle with Thieves (see 2), Entries 38 and 51
- 6: Journal Entry 41
- 7: Cabinet (treasure)
- 8: Caskets (need high-level Thief)
- 9: Brief battle (weapons)
- 10: Journal Entry 48
- 11: Treasure
- 12: Three cabinets (treasure)
- 13: Treasure and weapon
- 14: Journal Entry 29

Wealthy Area

- A: To Mansion
- B: To Temple
- C: To Boat to Phlan
- 1: Large Mansion with Black Hand symbol
- 2: Clue on how to enter Temple
- 3: Trapdoor (main treasure)
- 4: Skeleton (treasure)
- 5: Tapestry (treasure)
- 6: Major battle, Entry 53

Temple of Bane

- A: To Wealthy Area
- 1: Entrance (must have Holy Symbol from random encounters in Wealthy Area)
- 2-4: Treasure
- 5: Altar (do not defile)

The Valhingen Graveyard

- A: In/out
- 1: Read Journal Entry 43 and sanctify coffin.
- 2: Vampire (fight till he becomes mist)
- 3: Fight Vampire, who can't enter coffin if it's sanctified, until he's killed.
- 4: Skeleton army
- 5: Giant Skeleton (treasure)
- 6: Skeletons attack; don't enter building.
- 7: Spectre (treasure)
- 8: Treasure (Zombie Army guards main entrance.)
- 9: Mummies
- 10: Wraith and treasure (Wights and Zombies guard main entrance.)
- 11: Spectre (treasure)
- 12: Treasure (Spectres guard main entrance.)

Kobold and Wyvern Caverns

- A: To Small Cave
- B: To Large Cave
- 1: Wyvern (treasure)
- 2: Give water to Kobold, let him live, get Entry 20.
- 3: Journal Entry 42
- 4: If going west to east, you fall to X. If Wyvern is dead and you're going east to west, drunk Kobold leads you to King and battle. So avoid this hall.
- 5: Princess Fatima (give her +armor and weapons, let her join)
- 6: Journal Entry 42
- 7: Major battle (see solution)
- 8: King's Guard
The Kobold King
- 10: Main Treasure
- 11: Efreeti bottle (tell truth)

Yarash's Pyramid**Level 1**

Walls and doors appear and disappear as you move through this maze. All teleporters are not shown, just those needed for this solution.

- A: Teleport to B
- P: If lost, be Nice to Priest.

Level 2

- B: Teleport from A
- C: Teleport to D
- D: Teleport from D
- E: Teleport to E
- F: Teleport to G
- G: Teleport to H
- 1: LizardMen (be Nice)
- 2: Search for notes on experiments
- 3: Vats and Mutants Lizard Men
- 4: Torture Room

Level 3

- H: Teleport from E
- 1: Door and password
- 2: LizardMen (Be Nice and get password, or fight)
- 3: Yarash
- 4: Machinery
- 5: Teleporter to treasures and Pyramid exit

Lizard Men Castle & Catacombs

- A: In/out
- B: Stairs up/down to Catacombs (preferable entrance)

- C: Pits to catacombs
- D: To Swamp
- 1: Lizard Men & Giant Lizards
- 2: Giant Lizards
- 3: Pools (search after slaying all Lizards)

Zhentil Keep Outpost

- A: Main Gates
- 1: The Captain
- 2: Your Quarters

Stojanow Gate

- A: To Plaza
- B: Main Gate To Castle Valjevo
- 1: Merchant (wagon)
- 2: Southern, Northern Gates
- 3: West Tower
- 4: East Tower

Valjevo Castle

- : (In Maze, these are random teleports.)
- X: To/from Stojanow Gate
- a: Laundry (be Nice to get disguises)
- b: Smithy (weapons at night)
- c: Bane Chapel (don't accept blessing)
- d: Giants (treasure)
- e: Guardpost (Parlay w/ Haughty and say *uzsbouisbyvt*)
- f: Main Gate (password *sipejb*, but don't go this way yet)
- g: Giants (Parlay with Haughty to get password)
- h: Guardpost (Parlay w/ Haughty and say *uzsbouisbyvt*)
- i: Armory
- j: Kitchen (Gate Password)
- k: Records (clues)
- l: Guardpost (Parlay w/ Haughty and say *uzsbouisbyvt*)
- m: Well (treasure)
- n: If Cadorna is here, free him to get password to gate.
- o: Main Gate (open w/ Strength, Knock or password *sipejb*, go other Main Gate at f)

The Tower, Levels 1 and 2

- 1: False Tyranthrus
- 2: Stairs up
- 3: Medusa (avoid)
- 4: Trap door (avoid)
- 5: Messenger (be Nice)
- 6: Genheeris (slay and get wand)
- 7: Tyranthrus

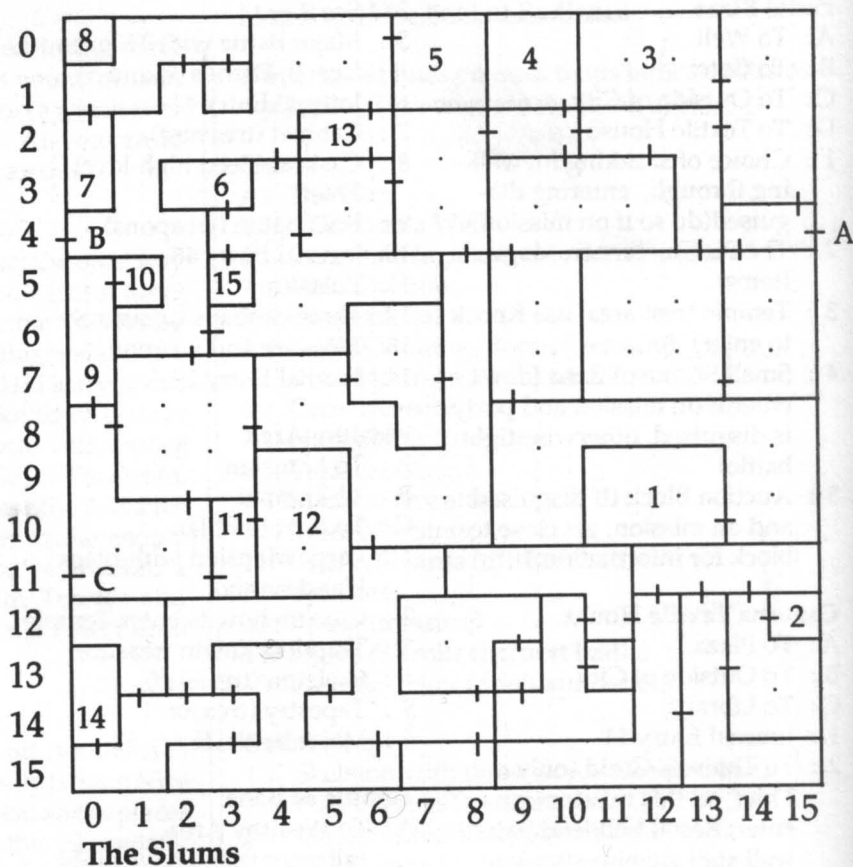

The Slums

Sokal Keep

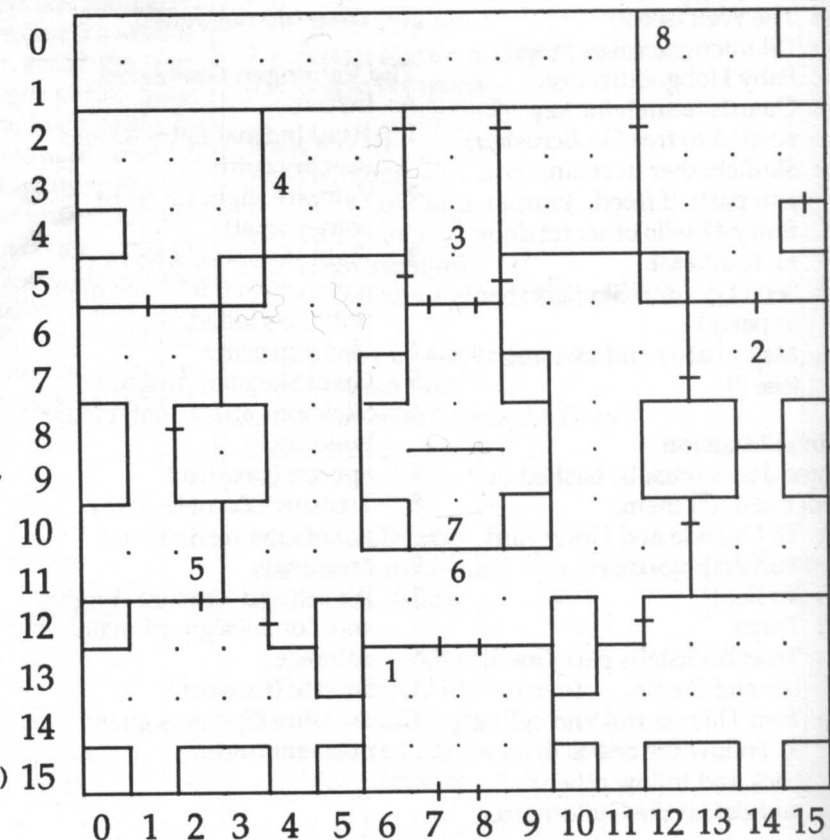

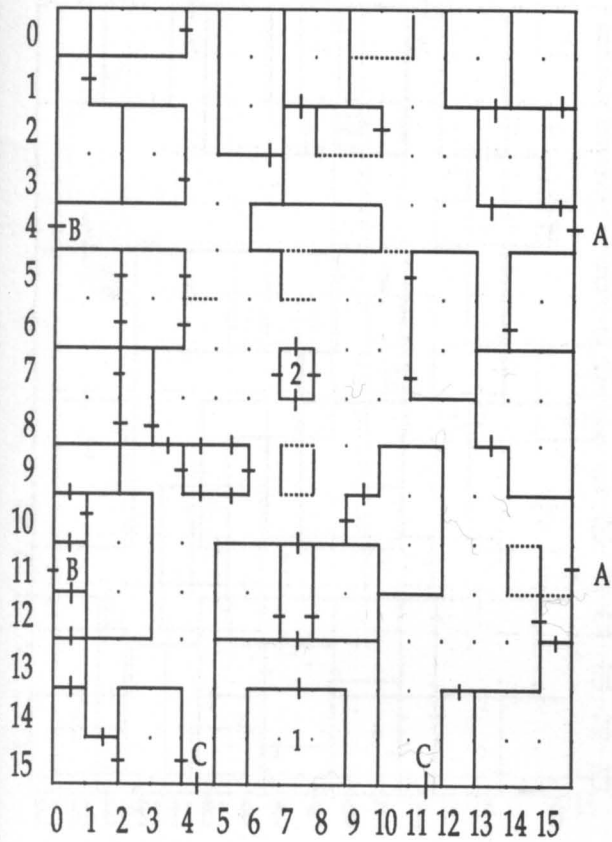

Kuto's Well

Catacombs under Kuto's Well

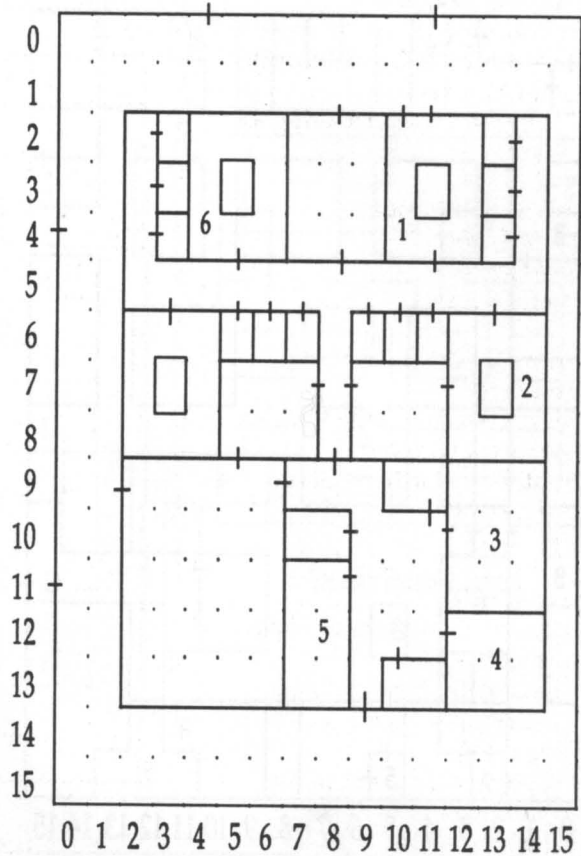
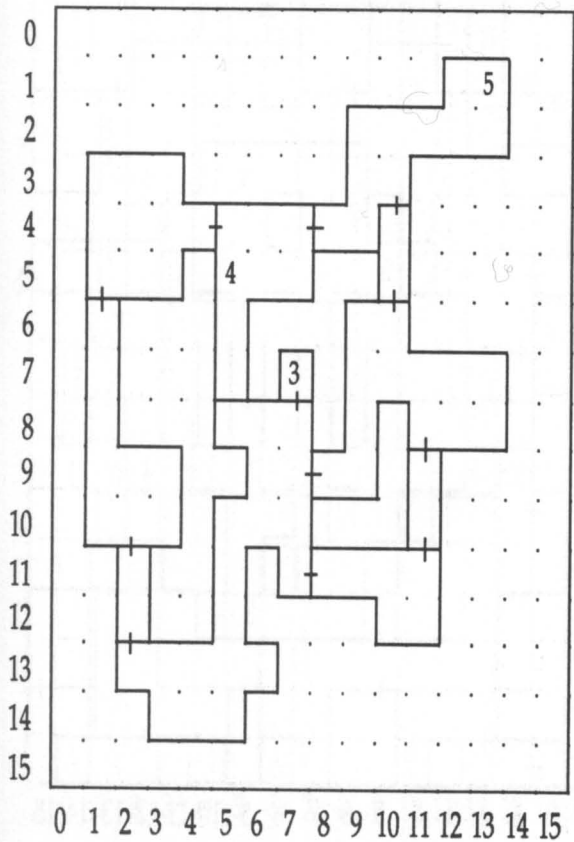

Mantor's Library

Podol Plaza

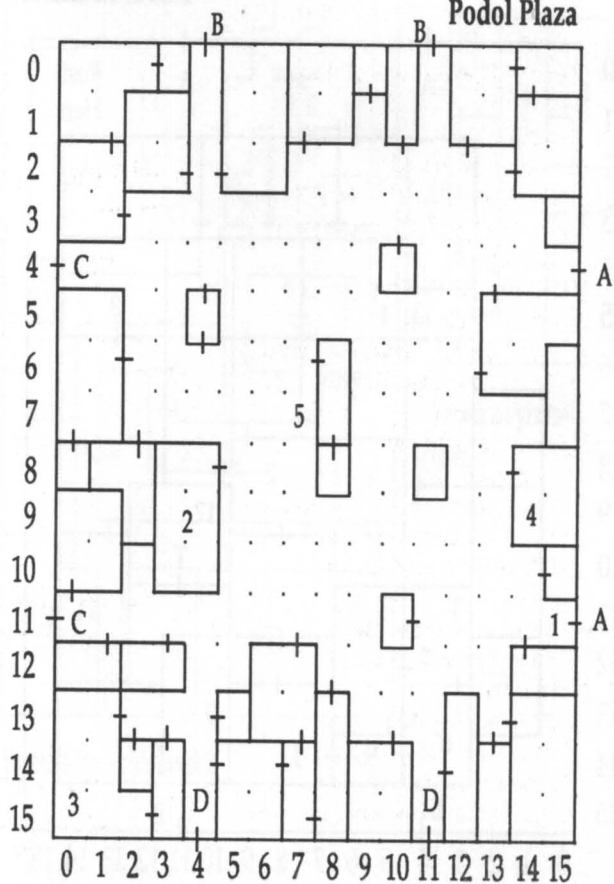

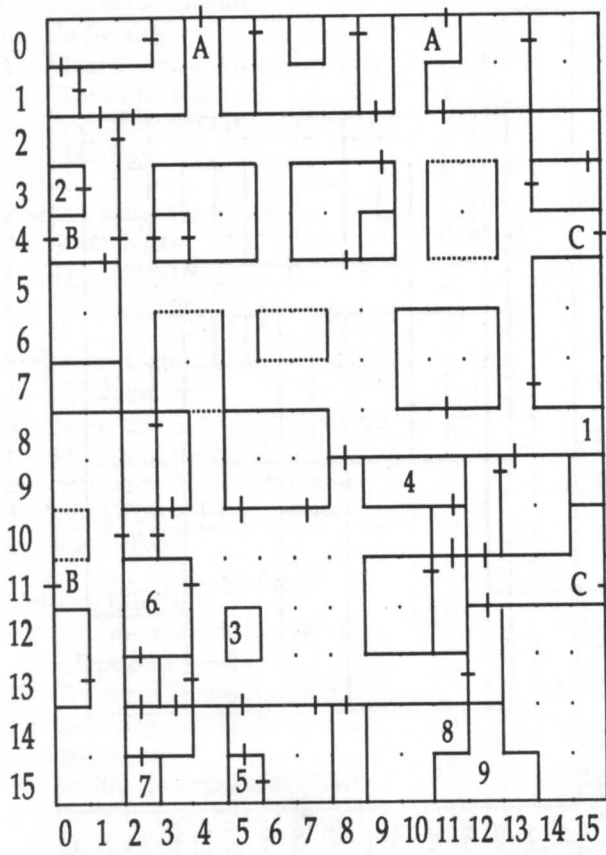

Cadorna Textile House

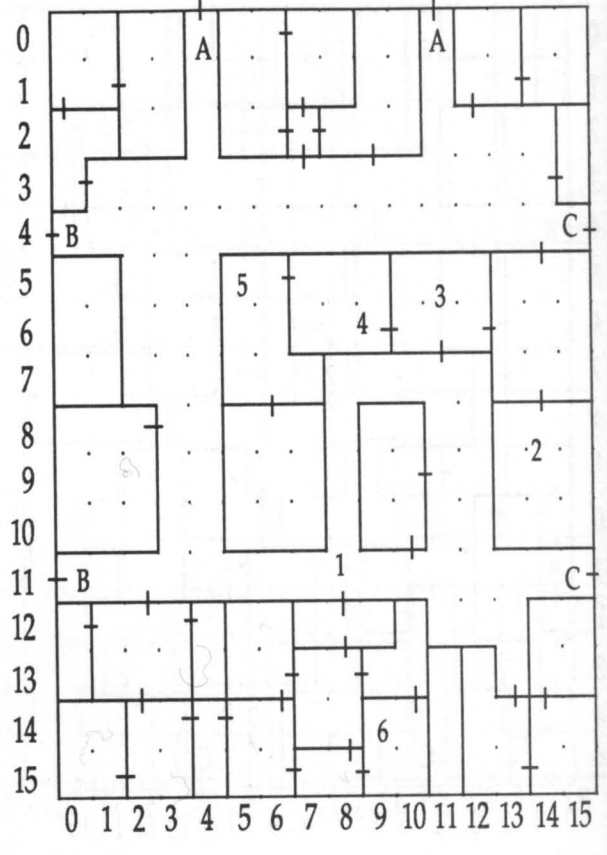

Koval Mansion

Wealthy Area

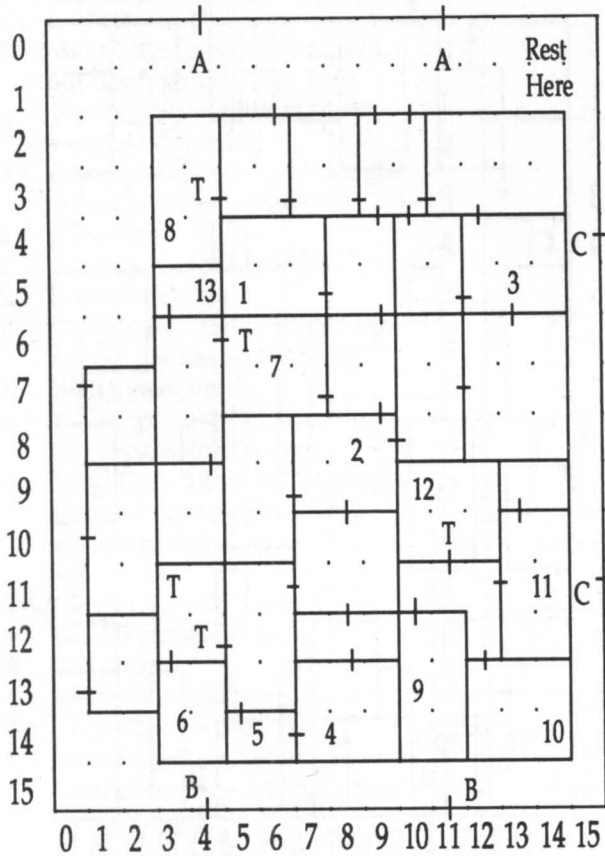

Temple of Bane

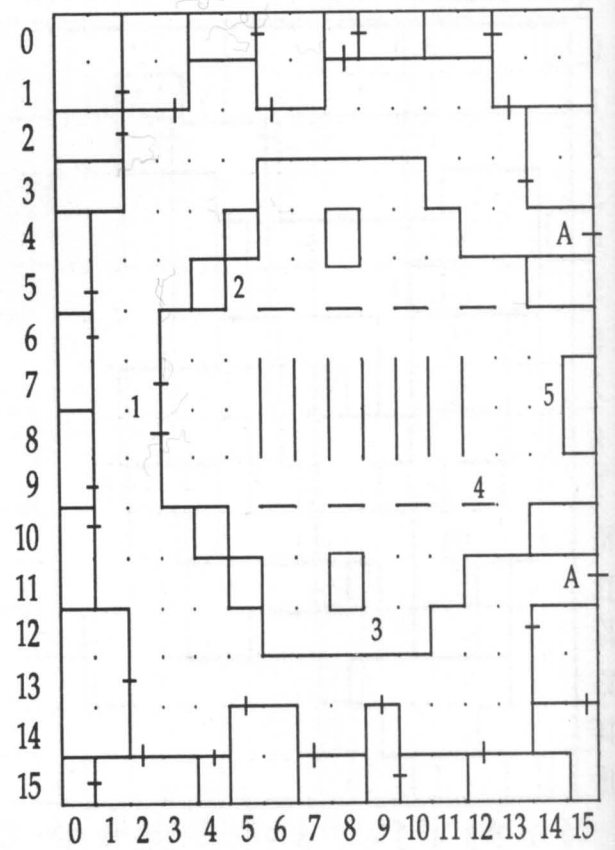

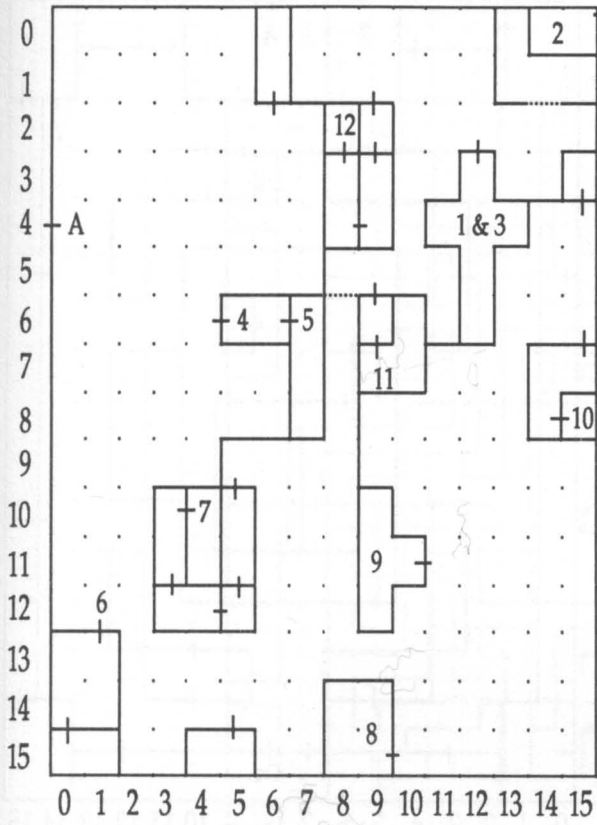

Valhingen's Graveyard

Kobold and Wyvern Caverns

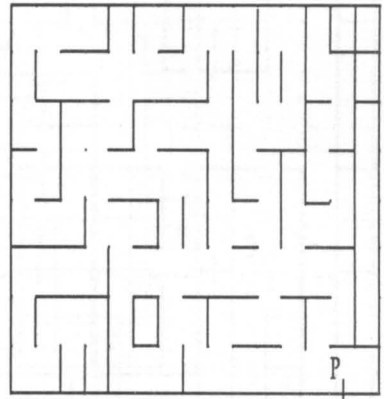
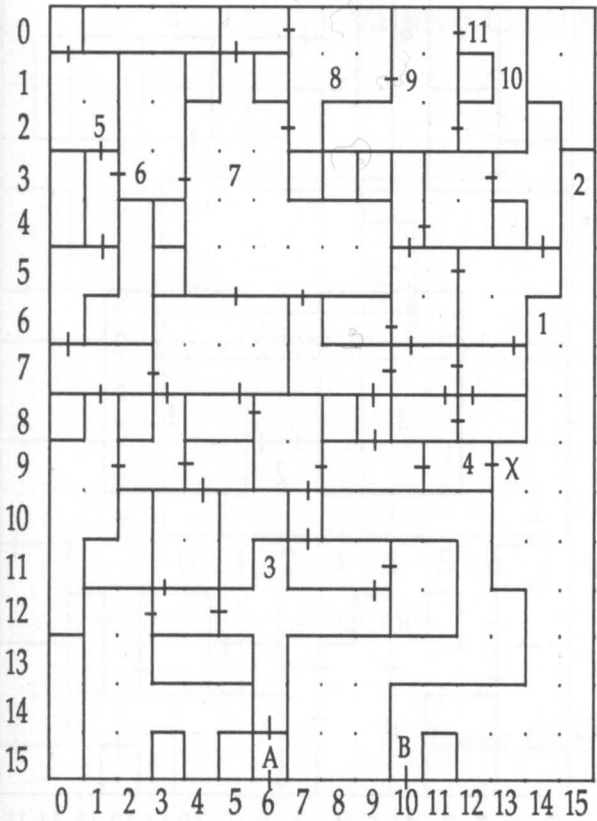

Yarash's Pyramid, Level 1

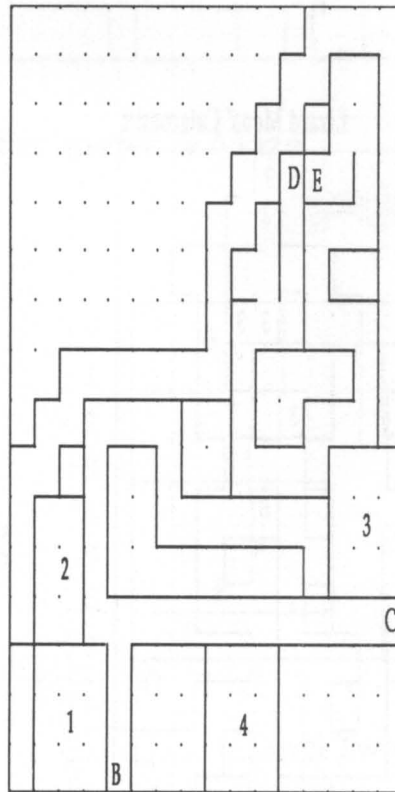

Yarash's Pyramid, Level 2

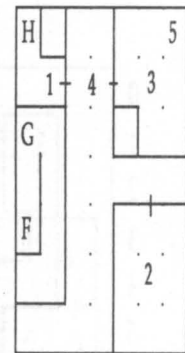

Yarash's Pyramid, Level 3

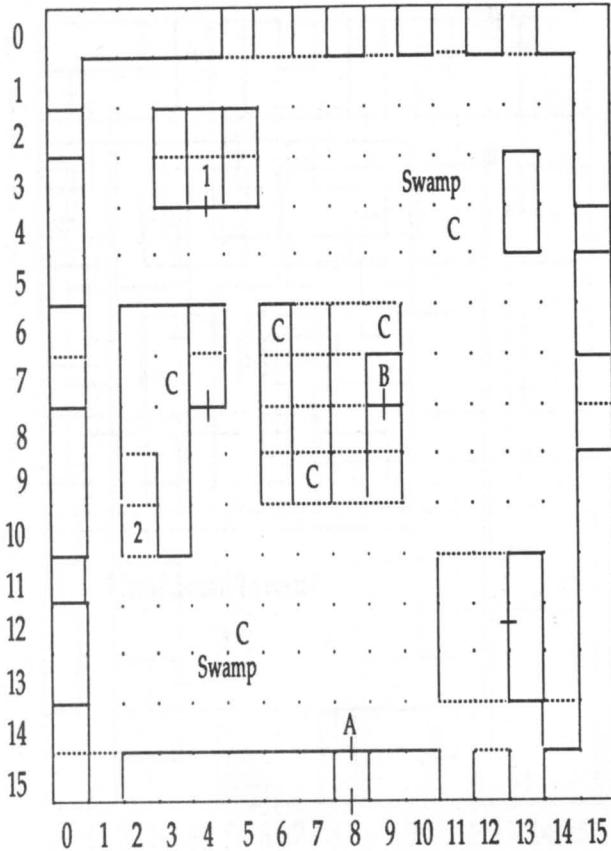

Lizard Mens' Castle

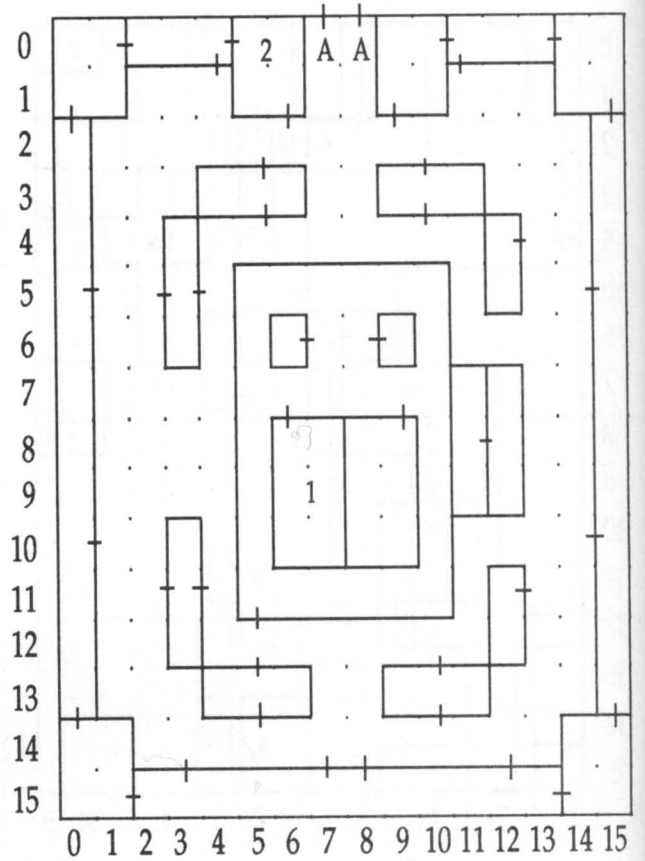

Zhentil Keep

Lizard Mens' Catacombs

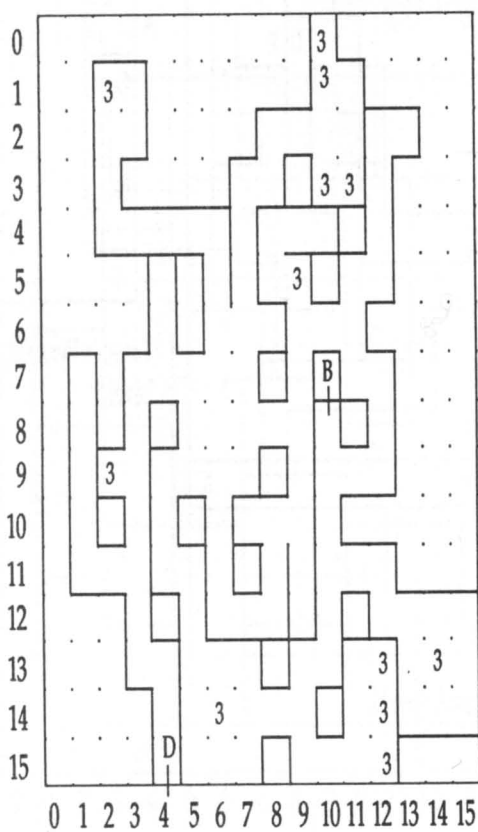

Stojanow Gate

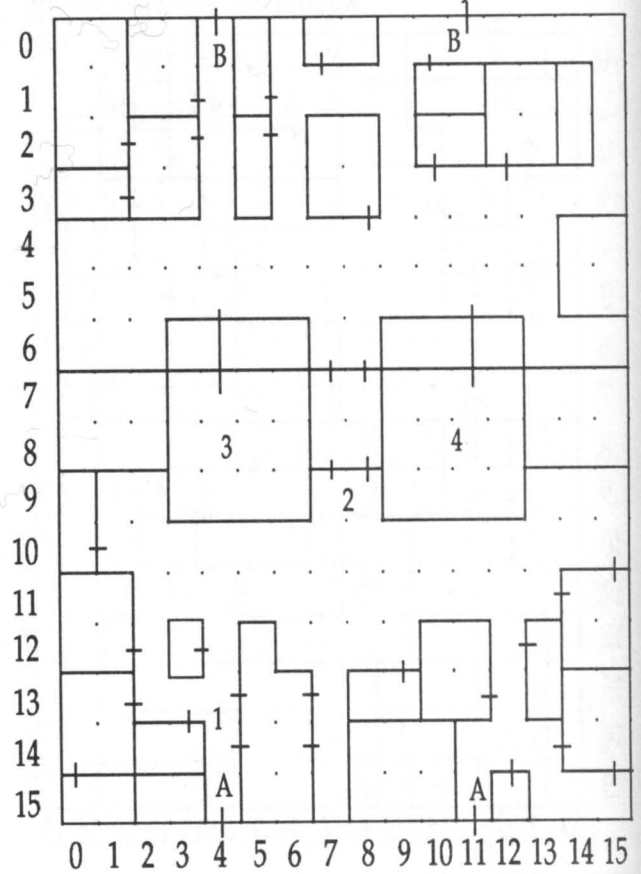

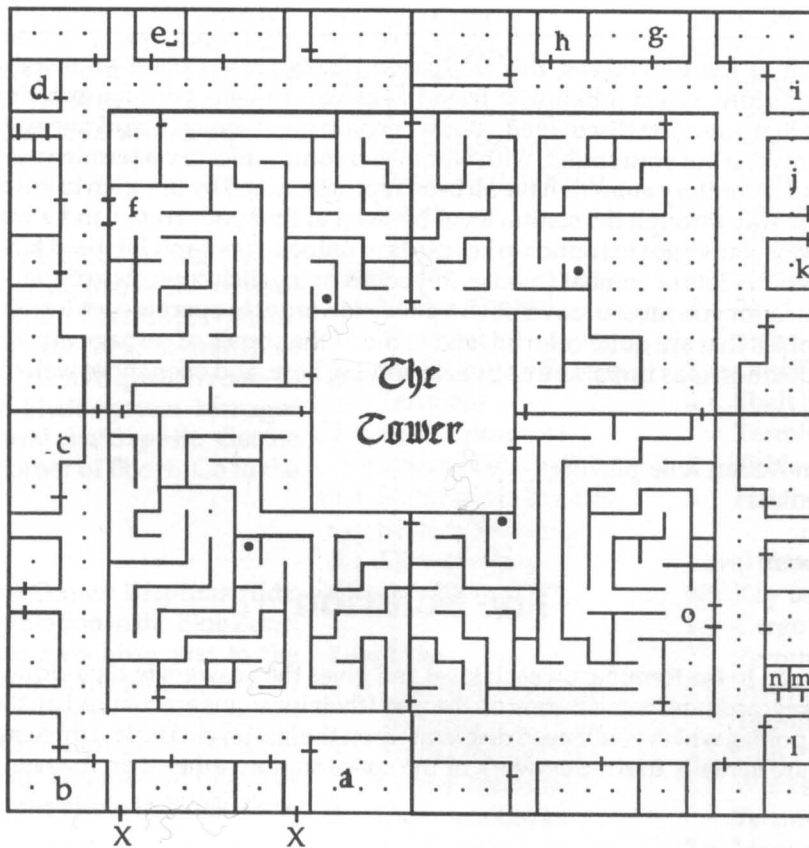

Valjevo Castle: Perimeter & Maze

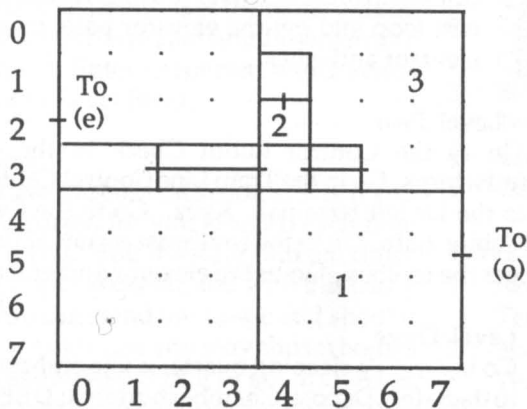

Level One

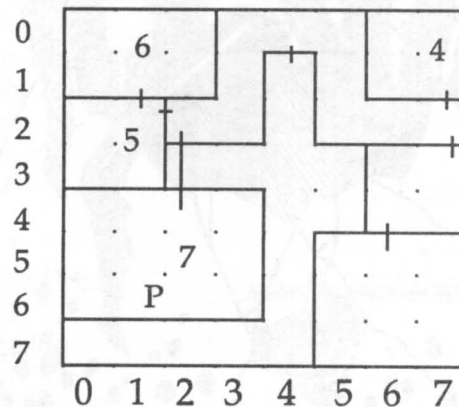

Level Two

Valjevo Castle: The Tower

Alien Mind

Somewhat reminiscent of the film *Aliens*, this fast-paced puzzler takes place on a space station several hundred years in the future, when a biologist friend asks you to help with an experiment on a pair of unhatched alien eggs that were just discovered. But when you get there, you find one egg has hatched and the alien has killed everyone but your friend, with whom you communicate via terminals scattered about the station. The robots and laboratory animals have all been reprogrammed by the alien to kill anything they see, so you must blast your way through the station level-by-level to find your friend and a way to wipe out the monster. Along the way you've got to round up keycards to unlock doors and First-aid kits to restore Health points. While this involves lots of combat (mouse, keyboard or joystick controls are available), the game is also packed with riddles, for you must unravel such a puzzler in order to operate each terminal. It's presented with aerial-view graphics that are quite colorful, and some of the scenes of carnage are almost too realistic. Good hand-eye coordination is as important as puzzle-solving here, and even those well-skilled in both will have their hands full.

Type: Science Fiction Action Role-playing
Skill Level: Intermediate
System: IIGS
Company: PBI Software

The Solution

This solution guides you to the terminal on each level and gives the answers to the riddles. It's up to you to pick up first aid kits, keycards and ammunition on the way (their locations are marked on the map). Conserve keycards and Health points, which you'll need desperately on the last level. The last three maps look different because these levels are actually in the ductwork of the space station rather than its main structure.

Level One

Go to the room

southeast of the Main Waiting Room, then to the lower right terminal (Visitor Control Terminal): **ufmfhsbn**. Go to the pulsating shaft chamber, then to the upper right terminal (Shaft Control System): **brvb**. Go to the Computer

Room, then to the lower right terminal (Main Computer System: **ibnnpdl**). Go to the Docking Terminal, then to the middle right terminal (Station One Control System): **sbejbujpo**. Go to the southeast loop and get the elevator pass, then to the elevator and enter.



Level Two

Go to the Control Room Check in the station: **fmfwbups**. Go to the Tram Line Control Center, then to the far left terminal: **Kvez**. Go to the Captain's Cabin: **tjsfo**. Go to the southeast corner of floor and get the toolbox. Go to the elevator and enter.

Level Three

Go to Avery's sleeping quarters: **Cjpmphjtu ip!** Go to the Safety Deposit Chamber terminal: **DEFGHBC**. Go to the Biologists' Lounge: **mjhiu**. Go to the Visitors' Chamber. Get crowbar. Go to the grate (south hallway) and enter.

Level Four

Go to the Recreation Floor info terminal: **cjp-mbc**. Go to the Sportscasting terminal (top right terminal): **tpncsfsp**. Go to the Viewer terminal next to the private courts (middle

terminal): **hmbtt**. Go to the home stands and get remote control. Go to the stairways.

Level Five

Go to the Botanist Terminal in the main terrarium in the southwest wing (bottom terminal): **NDMYJW**. Go to the Test Tube Storage closet: **fbs**. Go to the Bio-lab terminal (southwest part of lab): **ufmftdpqf**. Go to the chute and enter.

Level Six

(See Map Key for a way of saving Health Points when destroying one of the mines.) Go to the Maintenance Clearance System: **Bumboujt**. Go to the next terminal as directed: **usbotju**. Get **hvo qbsu** in room to **opsui**. Go to the Shaft System Manager (near the south central shaft): **pbtjt**. Get the cable (southwest corner of floor). Go to the hatch and enter.

Level Seven

Go to Cargo Control Center: **ijfspmzqijdt**. Go to the Inventory Station in the Blue Zone: **ebtfm**. Get **tfdpoe hvo qbsu** just to the **tpvui** of your location in the Blue Zone (you must destroy the stationary gun to get it.) Go to the Worker Communications module in Orange Zone: **bsl**. Get manual (north of Blue Zone). Go to the chute in Black Zone and enter.

Level Eight

Go to the Asbestos Suit closet: **bouijmm**. Go to the terminal southeast of the Southern Cross (Disposal Coordinator): **jhmpp**. Now get the final **hvo qbsu** northwest of this level's starting point. Get the battery pack. Go to the teleport terminal (southeast corner): **cmbdl ipmf**. Enter teleporter (which sends you back to Level Five).

End Game

Have at least 3,500 Health points when you enter teleporter, for you lose 300 each time alien hits you. You must hit him ten times with the Super Weapon, and with this many points you can stand toe-to-toe and shoot it out. (Don't move, or you may slip on bodies and get shot while trying to get up.) After killing it, get the serum from Avery and proceed quickly to the **tfdpoe fhh** so you can **ofvusbmjaf** it before it **ibudift**. Hurry, for your Health points start dropping in a count-down while you search for the egg.

Map Key: Alien Mind

S : Shield
F : First Aid
K : Key Card
C : Conductor
A : Ammo
Y or N: Do or do not enter these areas
Dark lines: Locked doors

Level One

1 : Visitor Control Terminal
2 : Shaft Control System Terminal
3 : Main Computer System Terminal
4 : Station One Control System Terminal
5 : Elevator Pass
6 : Elevator

Level Two

1 : Control Room Check Terminal
2 : Tram Line Control Center Terminal
3 : Captain's Cabin Terminal
4 : Toolbox
5 : Elevator

Level Three

1 : Avery's Sleeping Quarters Terminal
2 : Safety Deposit Chamber Terminal
3 : Biologists' Lounge Terminal
4 : Crowbar
5 : Grate

Level Four

1 : Recreation Floor Terminal
2 : Sportscasting Terminal
3 : Viewer Terminal
4 : Remote control
5 : Stairs Down

Level Five

1 : Botanists' Terminal
2 : Test Tube Storage Closet Terminal

3 : Bio-lab Terminal
4 : Chute
5 : Second egg

Level Six

S*: Get this shield before going to 6 to avoid losing points when destroying mine.
** : Mine
K* : Key under Mine
1 : Maintenance Clearance System
2 : Next Terminal (as directed)
3 : Gun Part
4 : Shaft System Manager Terminal
5 : Cable
6 : Hatch

Level Seven

K* : Key under gun
1 : Cargo Control Center Terminal
2 : Inventory Station Terminal
3 : Gun Part
4 : Worker Communications Terminal
5 : Manual
6 : Chute

Level Eight

1 : Gun Part
2 : Asbestos Suit Close Terminal
3 : Southern Cross Terminal
4 : Battery Pack
5 : Teleport Terminal
6 : Teleporter

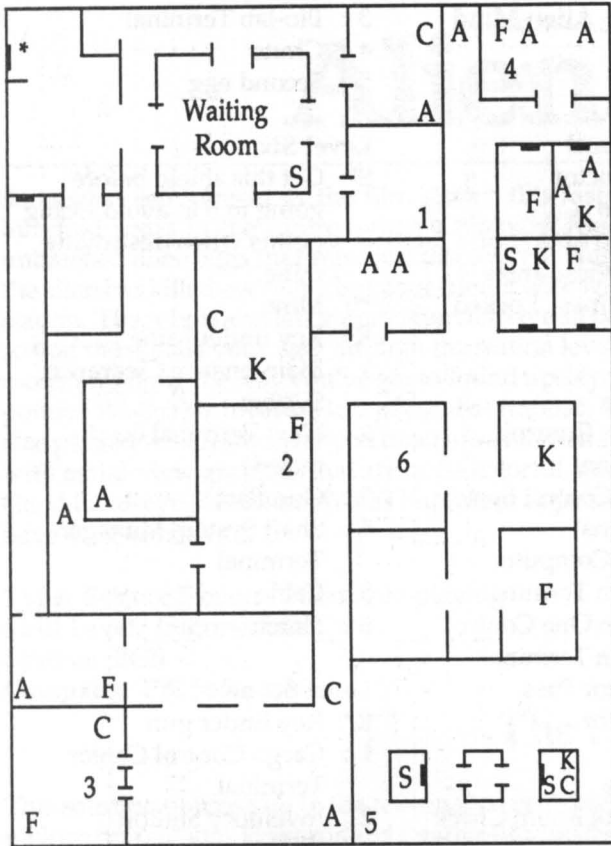

Level One

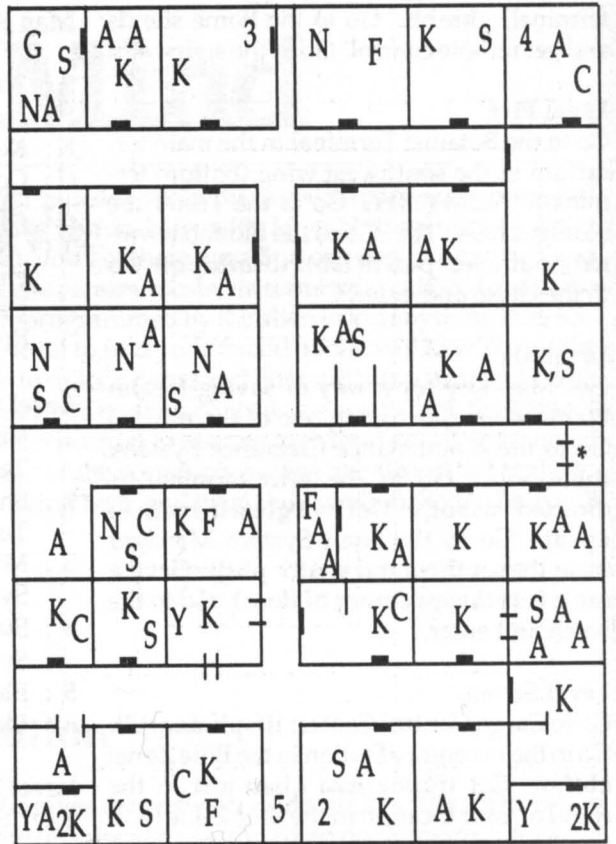

Level Three

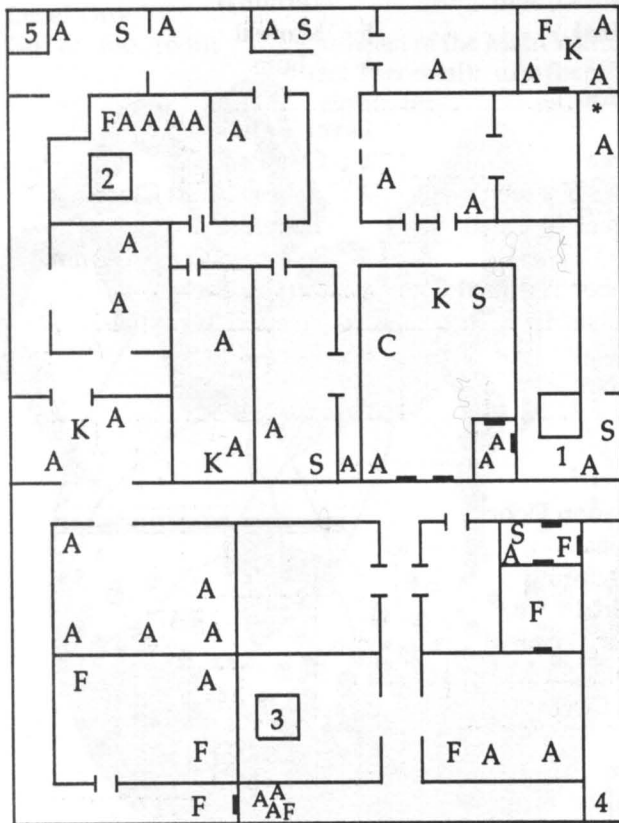

Level Two

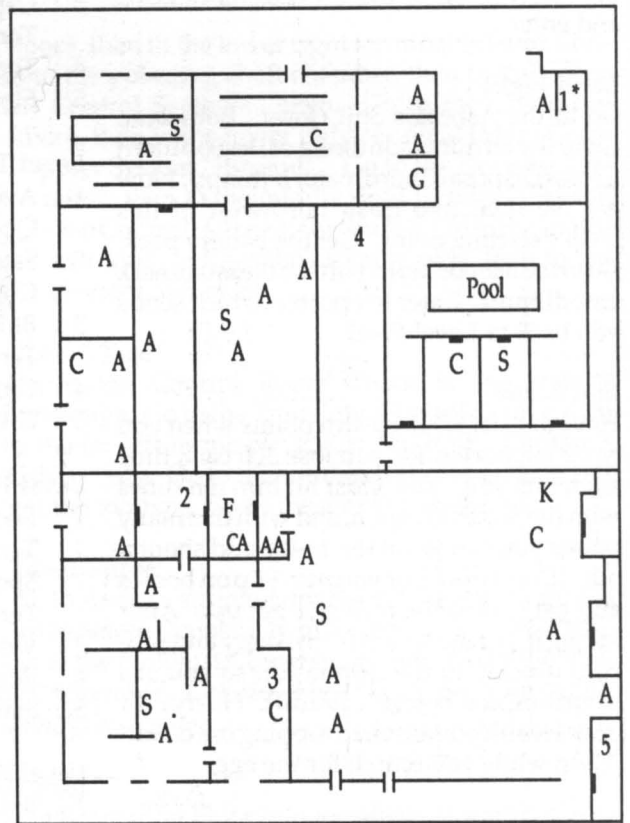

Level Four

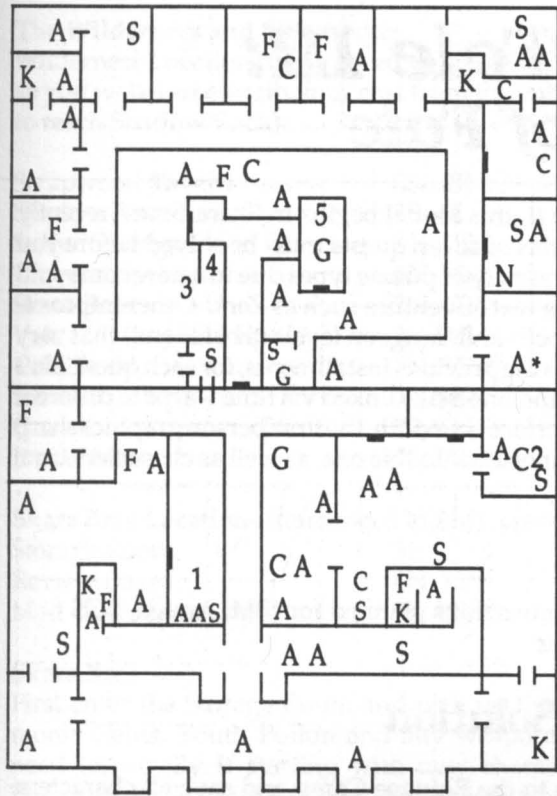

Level Five

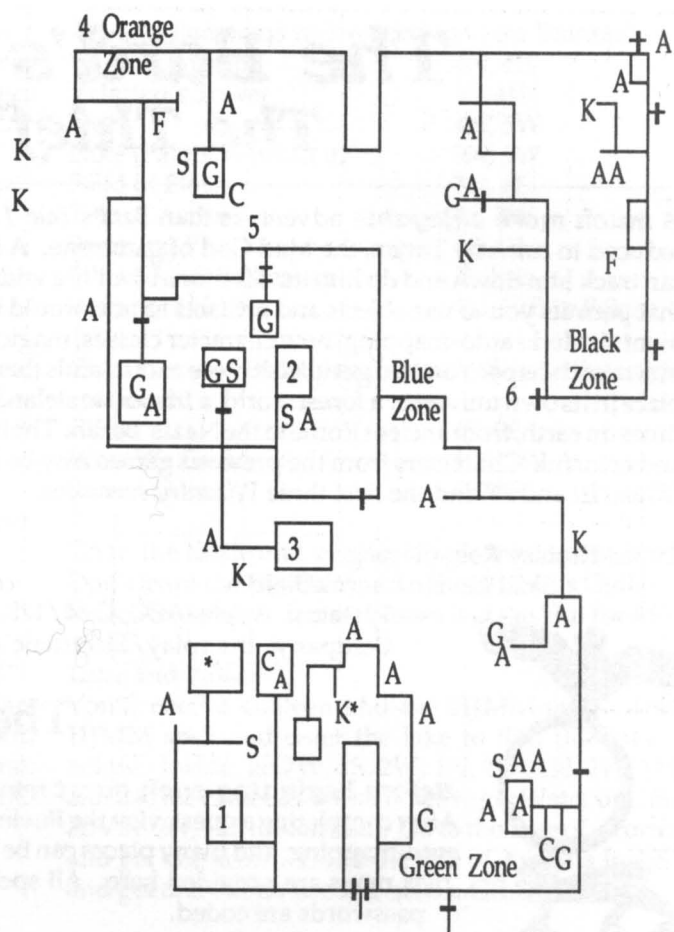

Level Seven

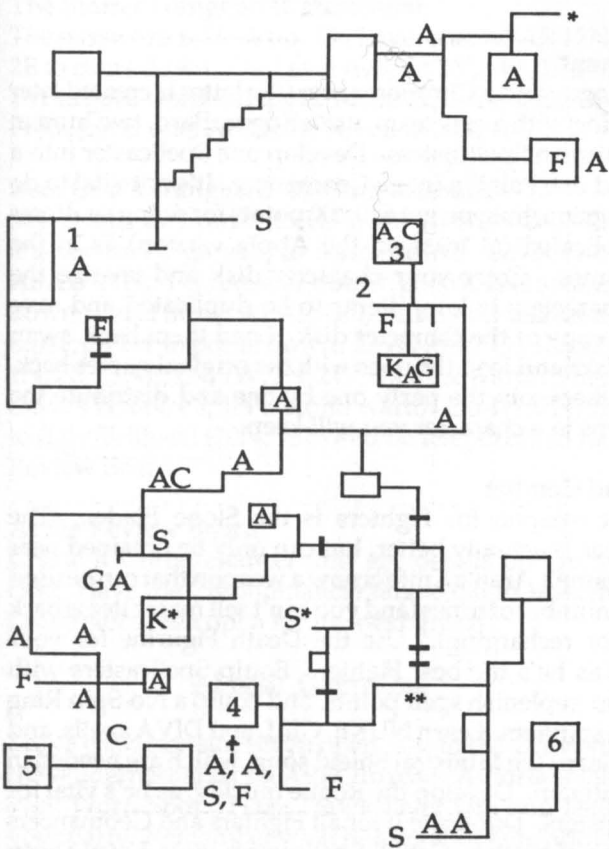

Level Six

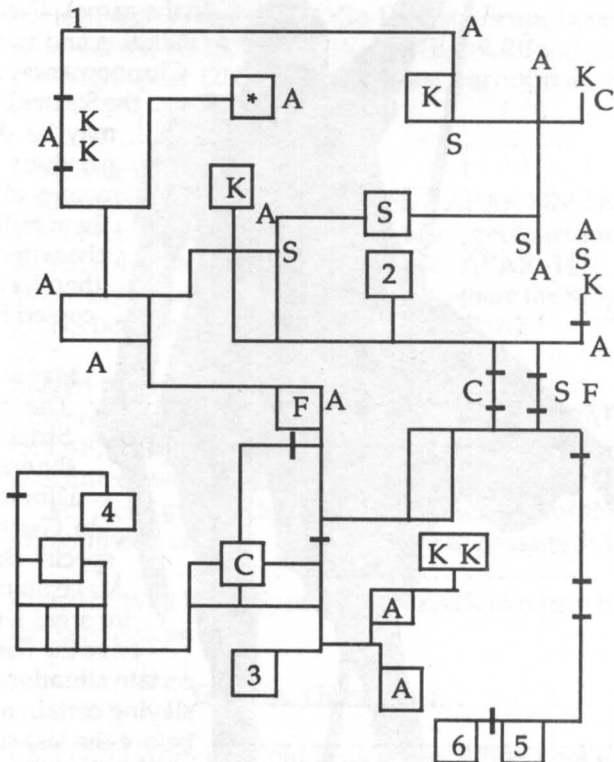

Level Eight

The Bard's Tale III: The Thief of Fate

A much more enjoyable adventure than *Bard's Tale I* or *II*, this sequel begins in Skara Brae—recently reduced to ruins by Tarjan, the Mad God of game one. A series of seven quests must be solved before you can track him down and do him in. Missions involve a wider variety of puzzle types due to a new command that permits you to use objects and artifacts as you would in a text adventure such as *Zork*. Other improvements include auto-mapping, new character classes, magic spells and dungeon levels (84 of them!) that vary in size and shape. You also get to visit more exotic lands than in the previous installments, for each quest takes place in its own universe: a forest world, a frozen wasteland, and one that's linked via time warps to different times on earth, from ancient Rome to the Nazis' Berlin. The interface is smooth, the first-person graphics sharp and colorful. Characters from the previous games may be imported into this one, as well as characters from *Ultima III* and *IV* and the first three *Wizardry* scenarios.

Type: Fantasy Role-playing

Skill Level: Intermediate

Systems: Apple (64K), C 64/128, conversions planned for IBM, Amiga, IIGS

Company: Interplay/Electronic Arts

The Solution

Before beginning each quest return to the Refugee Camp and save all characters. After completing a quest, visit the Review Board for the next one. Since the game includes auto-mapping, and many places can be reached with the APAR spell, only the most complex maps are provided here. All spells in solution (except the introductory tips) and passwords are coded.

Character Development

You'll need a Bard, Rogue and a Chronomancer (the latter is created later in the game). If starting with a new team, use a Rogue, Bard, two human Paladins and two human Spellcasters. Develop one Spellcaster into a Chronomancer and one Paladin into a Geomancer. It's not vital to do the Starter Dungeon, but you get 600,000 points for doing so. Items may be duplicated (at least on the Apple version) as in the previous games. Copy your character disk and change the names of characters holding items to be duplicated and save them to the copy of the character disk. Load them back, swap character disks and load the ones with the original names back, then have them join the party one-by-one and distribute the copied items to a character you will keep.

Magic and Combat

The best weapon for Fighters is the Stone Blade. (The Strifespear is actually better, but can only be obtained near the end game.) Aran's Knife is now a weapon that can be used a limited number of times (and you can't sell magic items back to Garth for recharging). Use the Death Figurine for your special slot, as he's the best Fighter. Equip Spellcasters with Mage Staves to replenish spell points, and equip a No-Spin Ring for areas with spinners. Learn NUKE, GILL and DIVA spells, and have the Bard learn the Minstral Shield song, which are needed in certain situations later on. Develop the Rogue quickly, as he's vital for slaying certain monsters. Duplicate it for all Fighters and Geomancers before the last series of battles. Get all Spellcasters up to Level Seven quickly so you can use the APAR spell.

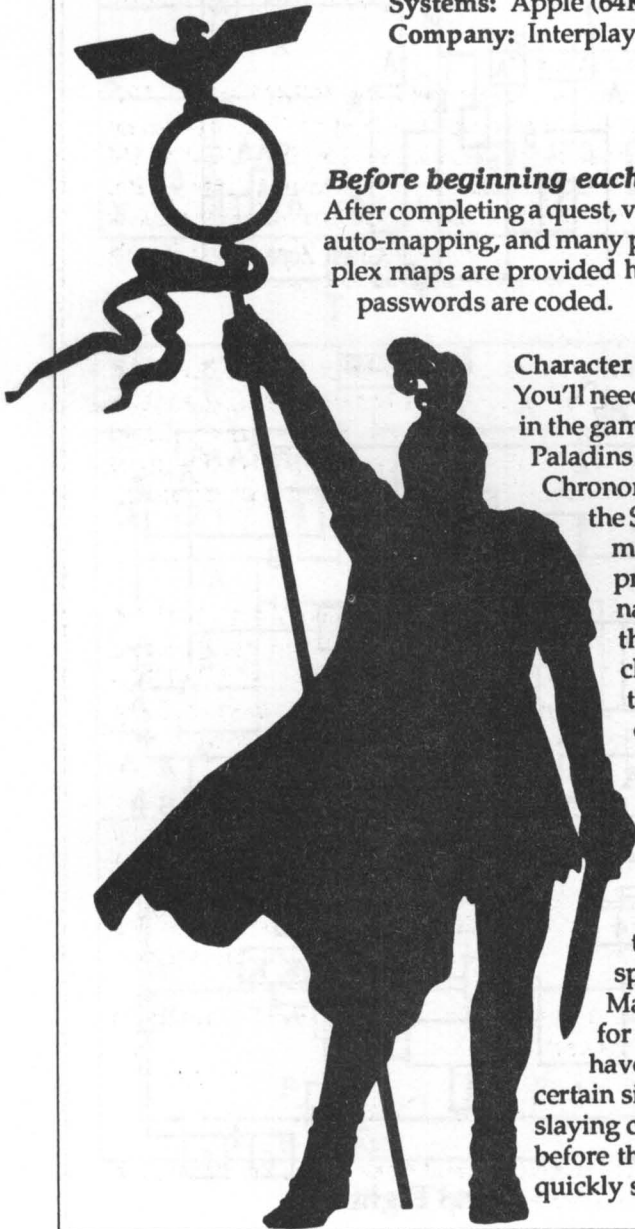

The Wilderness and Skara Brae:

Wilderness Locations (referenced to Refugee Camp, so you walk three south, four east from the entrance to reach Shadow Rock):

Scrapwood Tavern	0N, 2E
Shadow Rock	3S, 4E
Sulfur Springs	11S, 3E
Chrystal Springs	5N, 2E
Skara Brae	3N, 6W
Vale of Lost Warriors	2S, 5W
Cold Peak	7N, 15W
Shrine	3S, 14W
Grove	7S, 9W
Dwarf Mine	9S, 13W

Skara Brae Locations (referenced to town entrance):

Storage Room	3E
Review Board	4N, 15E
Mad God's Dungeon	9S, 13W

Skara Brae

First enter the Storage Room and pick up the Harmonic Gems, Youth Potion and any weapons you need (especially if starting with new characters). Then go to the Review Board for instructions from the Guild Master.

Mad God's Dungeon:

The Starter Dungeon (Catacombs)

The password is Ubskbo. On Level one, APAR 12N, 2E to stairs down. On Level two, go 2N, 1W, 2S and 1W to get a word—Dibpt). Move 2E to the stairs up. From Level one, APAR -12N, -2E to stairs out.

Mad God's Dungeon: Battling Brillhasti

Say Dibpt this time. Level one: APAR 14N, -3E, answer cmvf, go east to stairs down. Level two: APAR -11N, -11E, answer tibepx, go 1W, 2N to stairs down. Level three: APAR -5N, 2E, answer dsztubm txpse, go 1W to portal down. Level four: Go 1N, 1E, 1N, 2E, 2S, 4E, 2N, 1W, 2N, 2W, 2N (first ward). Then move 4W, 6N, 4E, 1N (second ward). Go 4W, 7N, 1E to fight Brillhasti (20N, 13E) and be teleported to the Review Board.

At the Review Board

Create a Chronomancer and get details on Quest One. Have the Chronomancer talk to Guild Master. Leave slot seven open for the next quest.

Arboria: Quest One

Leave character slot seven open. Go to the Grove in the Wilderness and cast ARBO to reach Arboria at the Well Worn Spot. Have Hawkslayer join and lead your party. Remember what he says about the riddle (jdfcfsh).

Arboria Locations (referenced to Ciera Brannia)

Well Worn Spot	4N, 4E
Valarian's Tower	3S, 4W
Hut	4N, 5W
Lake (Palace beneath it)	3N, 5W
Field of Flowers	2N, 5E
Tree of Acorns	4S, 3W
Festering Pit	4S, 4E
Pile of Arefolia Leaves	2N, 4E
Water of Life	2N, 12E in Palace

Ciera Brannia Locations (referenced from the town entrance):

Castle	4S, 0E
Wizard's Guild	10S, 2W
Sacred Grove	6S, 0E

Go to the castle and get the King's mini-quest first. Don't learn the HJMM Spell in the Wizard's Guild—it's too expensive. Instead, learn it at the Hut for \$50.

Lake and Palace

You'll need a canteen and the HJMM spell. Use HJMM spell and enter the lake to find the Palace below. Inside, go 7W, 1S, 2W, 1N, 1W, 1N, 2W, 1N and use the canteen several times to get Water of Life. APAR -2N, 12E to stairs out. Go to the Tree of Acorns and get one acorn. Go to the Pile of Arefolia leaves and get one (when used, it casts a GILL spell.)

Valarian's Tower

You need an acorn and Water of Life. Level one: APAR 0N, 1E, 2U. Level three: Use acorn. Use canteen with Water of Life. Go 1E to stairs up. Level four: Go 1N, 1E, 1S, 1E, 2S, 4W, 3N, 1E, 1N, 2E and get the Nightspear (2N, 3E in northeast part of maze). APAR -2N, -3E, -3U to stairs out.

Festering Pit

You need the Nightspear. Level one: APAR 14N, 5E, 1D. Level two: Fight Garnath, get head, get heart and APAR 0N, 9E to stairs up. Level one: APAR -14N, -14E to stairs out. Return to the Castle, where the King grants permission to enter the Sacred Grove.

Sacred Grove

You need Heart of Garnath and Water of Life. APAR -5N, 4E, go 1S to Valeran (6N, 4E) and use Heart, then use canteen with Water of Life. Go 1N, 1S, 1E, 1S, 2W, 1S, 4E, 1S, 2E to . Get the Bow and Arrows of Life (9N, 9E, southeast corner). APAR 9N, -9E to passage out.

Go to the Well Worn Spot and cast ENIK to return to the Wilderness.

Gelidia: Quest Two

Cast GELI from the Cold Peak in the Wilderness to reach the Well Worn Spot in Gelidia.

Gelidia Locations (referenced from the Keep):

Well Worn Spot 8N, 1W
Outpost 5N, 4W

Outpost

Read the diary to get the name **Bmfoebs** and clues about magic required to open the wards.

Ice Keep to the Black Tower

A map of Level One is provided. You can reach Level two by saying the name from the diary. (There's nothing on Level two, though, so you should just proceed from Level one: From (1) on the map, APAR 0N, 10E to the Black Wall (2) in the southeast corner and cast **HSSF** (**NBGM** may work instead), **TITQ**, **GFBS**, **TVFM**, **TQCJ** and enter the passage to the Black Tower.

Black Tower

Level one: APAR 0N, 3E, 3U. Level four: Fight the Keepers of the Tower near the northeast corner, get the Black Lens and APAR 0N, -3E, -3U and enter the passage to the Ice Keep.

Ice Keep to the White Tower

Level one: APAR 9N, 0E to Magic Curtain at (3) in the northeast corner. Cast **MFWJ**, **BONB**, **QIEP** and enter passage to White Tower.

White Tower

Level one: APAR 4N, 3E, 2U. Level three: Read carving and remember the word **Dbmb**. APAR -4N, 1E, 1U. Level four: Fight Keepers of the Tower in the southeast corner, get Crystal Lens, APAR 0N, -4E, -3U to passage to Ice Keep.

Ice Keep to Grey Tower

Level one: APAR 0N, -11E to (4), in the map's northwest corner. Cast **JOXP**, **XJIF**, **GPGP**, **JOWJ** and enter passage to Grey Tower.

Grey Tower

Level one: APAR 0N, -3E, 3U. Level four: APAR 0N, 1E, go 2S and fight the Keepers. Get the Smokey Lens and APAR -3N, 2E, -3U and enter the passage to Ice Keep.

Ice Keep to the Ice Dungeon

Level one: From the northwest corner, APAR 0N, 5E to the circles on the floor (5). Use Crystal Lens. Use Black Lens. Use Smokey Len. Take passage to Ice Dungeon.

Ice Dungeon

Level one: Go 1W, 1S, 1E, 4S, 2E, 1S, 4E, 6N to stairs down. Level two: Go 4S, 2E, 3N, 2E (northeast area of maze) and say **Dbmb**. Go 1S, 1W, 2S, 1E and get Wand of Power and Sphere of Lanatir in the southeast corner. Go 1W, 2N, 1E, 1N, 2W, 3S, 2W, 4N to

stairs up. Level one: APAR 0N, -6E and take the passage to the Ice Keep.

Ice Keep

Level one: APAR -9N, -4E to stairs out. Go to the Well Worn Spot and cast **ECUL** to reach the Wilderness.

Lucencia: Quest Three

At the Crystal Springs in the Wilderness, cast **LUCE** to reach Lucencia's Well Worn Spot.

Lucencia Locations (referenced to Celaria Bree):

Well Worn Spot 5N, 1W
Rose Bush (no roses) 2N, 3W
Rose Bush (white roses) 4N, 6W
Rose Bush (yellow roses) 4S, 1W
Rose Bush (blue roses) 1S, 8W
Rose Bush (red roses) 5S, 6W
Violet Mountain 4N, 8W
Allirias' Tomb 0N, 7W
Cyanis Tower 4S, 5W

Celaria Bree Locations (referenced to the entrance):

Tavern 6N, 7E
Bard's Hall 6N, 9E
Temple 4S, 7E
Wizard's Guild 2S, 5E

First go to the Bard's Hall and pay 30,000 to learn Kiel's Overture. At the Wizard's Guild, pay 50,000 to learn **DIVA**.

Violet Mountain

You need a canteen. Level one: APAR 4N, 0E and go 2N, 1W to stairs up. Level two: APAR -10N, 3E, move 2E and fight the Rainbow Dragon (at 4N, 4E, lower part of maze). Get the Crystal Key. Use the canteen to get Dragon's Blood. APAR 10N, -5E to stairs down. Level one: APAR -6N, 1E to passage out.

The Rose Bushes

Go to each bush and get one rose from them in this order: white, red, blue, yellow. Then go to the bush with no roses and use the canteen with the **Esbhpo Cmppe** to get a Rainbow Rose.

Cyanis Tower

You need all five roses and the Crystal Key. Level one: Go 1N and use the Crystal Key. Move 5N, 4E and you'll be teleported to the southernmost hall on the same level. Go 2W, 5N, 4E, 4S, 3W, 3N, 2E, 2S, 1W, 4S, 1N to the stairs up. Level two: Go 1S, 1W, 2N, 1W, 4S, 1W, 5N, 2E, 1N, 1E, 1S to the stairs up. Level three: Go 1N, 3W, 1S, 1E, 1S, 1W, 1S, 1E, 3S, 5E, 6N, 2W, 1S, 1E, 4S, 2W, 1N. You may either fight Cyanis and get the Magic Triangle, or cast **REST** and cure him to get it. APAR -2N, -3N, -2U to passage out.

Allirias' Tomb

You need all five roses and Magic Triangle. Level one: Go 2E, 3N, 2E, 2N, 1W, 5N, 1E, 2S, 1E, 1S, 1E, 2N and use Magic Triangle to get past black crystal. Go north to stairs up. Level two: Go 4E, use white rose. Move 1E, 2N, 1W, 1N, 1W, 1N, 1W, 1N, 1W, 1N, 1W, 1S and use blue rose. Go 1S, 1E, 1S, 1E, 1S, 1E, 1S, 2W, 1N, 1W, 1N (get teleported to the northeast corner). Go 5W and use the red rose. Go 4W, 2S, 1E, 1S, 1E, 1S, 1E, 1S, 1E, 1S, 1E, 1S, 2E and use yellow rose. Go 2E, 7N, 7W, 2S, 1E, 1S, 1E, 1S, 1E, 1S, 1E, 1S, 2E, 5N, 3W, 2S, 1E, 1S, 1E, 1N and use rainbow rose. Go 1N, 1W and get the Crown of Truth and Belt of Alliria (in the middle of the maze's east side). APAR -5N, -9E to stairs down. Level one: Go 3S, 1W, 1N, 1W, 2N, 1W, 5S, 1E, 2S, 2W, 3S, 2W to the stairs out.

From Well Worn Spot, cast ILEG to reach Wilderness.

Kinestia: Quest Four

Leave one character slot open. From the Dwarf Mine in the Wilderness, cast KINE to reach the Well Worn spot. Go 1N, 2E, 1N, 1E and say jdfcfsh. Have Hawkslayer join the party and lead it. (There are four passageways here: the two on the east side go to the Private Quarters, the south one to the Barracks, and the north one to the Workshop.) APAR 9N, 14E to passage to Private Quarters.

Private Quarters

Move 3E, 4N, 2W, 1N, 1E. Record the riddle, which provides answers to turning the keys. Move 1W, 1S, 5E, 3S, 2E and get the left key. APAR -1N, -8E and enter the passage to Ferofist's Dungeon. APAR -11N, -6E to passage to the Barracks.

Barracks

APAR -12N, 0E and get the right key. APAR 12N, 0E to passage to Ferofist's Dungeon. APAR 17N, 2E to passage to Workshop.

Workshop

Go 2N, 4W to sealed portal. Use left key, type fifteen (type in the number, not the word). Use right key, type fjhiuffo. Take passage to Urmech's Lair.

Urmech's Lair and Viscous Plane

APAR 3N, 0E and enter the portal to the Viscous Plane. Go 1S, 1E, 1N, 1E, 2S, 3W, 2S, 2W, 3S, 1W, 2N, 3W, 1S, 2E, 2S, 1W, 1N, 1W, 1S to opening of the Sanctum.

Sanctum and Geomancer

APAR 4N, -6E and say yes. Go 4S, 1E to get Ferofist's Helm and Hammer of Wrath. Move 1W, 1S. Create a Geomancer here if you want one. APAR 0N, 6E and enter the portal to the Viscous Plane.

Viscous Plane to Well Worn Spot

Go 1N, 1E, 1S, 1E, 2N, 2W, 1N, 3E, 2S, 1E, 3N, 2E, 2N, 3E, 2N, 1W, 1S, 1W, 1N and enter the passage to Urmech's Lair. APAR -3N, 0E and enter the Workshop. Go 4E, 2S and enter the passage to Ferofist's. APAR -17N, -13E to Well Worn Spot. Cast OBRA.

Tenebrosia: Quest Five

From Shadow Rock in the Wilderness, cast OLUK to reach Nowhere.

Nowhere Locations (referenced to the city of Black Scar):

Well Worn Spot	1N, 3W
Tar Pits	2S, 6W
Middle of Nowhere	4S, 3W
Great Canyon	8S, 1W
Forest (Dark Copse)	6S, 7W

Black Scar Locations (referenced from the entrance):

Bard's Hall	8S, 4E
Wizard's Guild	8S, 9E

First visit the Bard's Hall and pay \$60,000 to learn Ministerial Shield. At the Wizard's Guild, learn NUKE for \$50,000.

Tar Quarry

You need the canteen. Go 10W, 8S, 5E, 1N and use the canteen to get tar. Go 1S, 5W, 8N, 10E to the exit.

Shadow Canyon

APAR -12N, 8E, face east and cast PHDO. Go 3E, 2S, 2E and get the Shadow Lock. APAR 14N, 0E to the exit.

Dark Copse

Go 1W, 4N, 1E and use the canteen of tar. Go 2N and get the Shadow Door. Move 2S, 1W, 4S, 1E to the exit.

Sceadu's Dome

Go to the Middle of Nowhere and use the Tibepx Epps and Tibepx Mpd1, then enter hole to the Dome. Level one: APAR 4N, 8E and go 1N to the portal down. (A map of Level two is provided.) Level two: From (1), APAR 10N, 7E to (2) and go 2N, 3W, 1N, 1E to fight Sceadu at (3). (Have a Rogue sneak up at 90' and kill him.) Get the Helm of Justice and Sceadu's Cloak, then APAR -13N, -5E to the portal up. Level one: APAR -5N, -8E to exit. From the Well Worn Spot, cast ECEA.

Tarmitia: Quest Six

Cast AECE from the Vale of Lost Warriors to reach Berlin. This "dungeon" consists of eight levels representing different eras of time. To use the time warps

that connect various eras, you must answer "Ghostly Head" riddles. In case the following walkthrough gets confusing, here are the coordinates, destinations and answers:

<u>Era</u>	<u>Time Warp</u>	<u>Destination</u>	<u>Answer</u>
Berlin	5N, 5E	Nottingham	Uzs
	6N, 10E	Wasteland	
	10N, 1E	Rome	
Rome	0N, 3E	Troy	Nbst
	6N, 2E	Hiroshima	
	8N, 9E	Berlin	
Nottingham	1N, 2E	Wasteland	Tu. Hfpshf
	8N, 1E	Stalingrad	
	1N, 10E	Berlin	
Wasteland	8N, 8E	Nottingham	Tejbcn
	13N, 4E	Berlin	
	4N, 1E	K'un Wang	
Stalingrad	11N, 9E	Nottingham	Twbsbyjd
	2N, 11E	K'un Wang	
	6N, 3E	Hiroshima	
K'un Wang	8N, 1E	Stalingrad	Zfo-Mp-Xboh
	6N, 10E	Wasteland	
	3N, 10E	Rome	
Hiroshima	8N, 7E	Troy	Tvtb-Op-P
	10N, 5E	Stalingrad	
	2N, 4E	Hiroshima	
Troy	5N, 7E	Rome	Bsft

Berlin to Rome and Troy

APAR 1N, 5E to and get the word Bsft. APAR 9N, -4E and enter passage to Rome. Rome: APAR -8N, -6E to passage to Troy.

Troy to Nottingham and Wasteland

APAR -1N, -5E, type Bsft and get ported to Nottingham. Get the word Zfo-Mp-Xboh, APAR -7N, -7E and enter the Wasteland passage.

Wasteland to K'un Wang and Berlin

APAR -4N, -7E to passage to K'un Wang. K'un Wang: APAR -3N, -6E, type Zfo-Mp-Xboh and get ported to Wasteland. Wasteland: get word Nbst, APAR 12N, 3E to passage to Berlin. Berlin: APAR 4N, -9E to passage to Rome.

Rome to Troy

APAR -2N, 0E, go 3W and type Nbst to get ported to K'un Wang. K'un Wang: Get word Tvtb-Op-P, APAR 7N, -2E to passage to Stalingrad. Stalingrad: APAR 4N, -8E to passage to Hiroshima. Hiroshima: APAR -9N, 5E, type Tvtb-Op-P and get ported to Troy.

Troy to Nottingham

Get word Twbsbyjd, APAR -9N, -1E and enter the passage to Hiroshima. Hiroshima: APAR 2N, -2E to passage to Stalingrad. Stalingrad: APAR -6N, 6E, type Twbsbyjd and get ported to Rome. Rome: Get word Tu. Hfpshf. APAR 8N, 8E to passage to Berlin.

Berlin: APAR -5N, 4E to passage to Nottingham.

Nottingham to Hiroshima

APAR 5N, -4E, type Tu. Hfpshf and get ported to Stalingrad. Stalingrad: Get word Tejbcn. APAR 3N, 0E to passage to Nottingham. Nottingham: APAR -7N, 1E to passage to Wasteland. Wasteland: APAR 7N, -6E, type Tejbcn and get ported to Hiroshima. Get word Uzs.

Hiroshima to Tarmitia

APAR -5N, 4E to passage to Rome. Rome: APAR 2N, 7E and enter passage to Berlin. Berlin: APAR -6N, 6E, type Uzs, type Xfssb and get ported to Tarmitia.

Tarmitia

APAR -11N, 0E and fight Werra and the Black Slayers. Go 1N and get the Shield. APAR 10N, 11E (to Wilderness).

Malefia: Quest Seven

Visit the Storage Room and get items needed for this quest. They must be equipped or carried. You also need Scedu's Cloak, Sphere of Lanatir, Valarian's Bow, Belt of Alliria, Ferofist's Helm and Werra's Shield.

From Sulfur Springs, cast EVIL to reach Malefia. Maps are provided for all three levels.

Level one: From (1), go 2N and get the Strifespear (2). (You may want to return to the Refugee Camp and duplicate this—see Character Development section.) Go 7N, 5W to (3) and get ported to (4) on Level three.

Level three: From (4), go 1S, 1W, 1S, 2W, 2N, 1W, 1S, 2W to (5) and use Sceadu's Cloak. Go 2E, 1N, 1E, 2S to the portal up at (6) to (7) on Level two.

Level two: From (7), go 1N, 3W, 1N, 3W, 1S, 2W, 1N to the portal up at (8) to (9) on Level one.

Level one: From (9), go 1S, 2E, 3S, 2E, 5S, 2W, 1S, 1W, 2N, 1E, 1N, 2W, 1S, 1W, 1N, 1W to portal down at (10) to (11) on Level two.

Level two: From (11), go 1E, 2S and use the Sphere of Lanatir at (12). Go 1N, 5E, 4N, 7E, 2N, 3W, 1N, 3W, 1N, 3W to portal up at (13) to (14) on Level one.

Level one: From (14), go 3E, 3S, 2E, 2S, 2E, 2S, 2E, 2S to portal down at (15) to (16) on Level two.

Level two: From (16), go 3N, 1W, 1N, 2W to (17) and use Valarian's Bow. Go 2E, 1S, 1E, 2S, 7W, 4N, 6W, 1N, 1W, 2N, 1W, 1N, 2W, 2S, 1W, 1S, 3W, 2S, 1E, 1N, 2E to portal up at (18) to (19) on Level one.

Level one: From (19), go 1E, 1S, 1W and use the Belt of Alliria at (20). Go 1E, 1N, 1W to portal down at (19) to (18) on Level two.

Level two: From (18), go 2W, 3S, 1E, 3S, 1W, 1S, 1W to stairs up at (21) to (22) on Level one.

Level one: From (22), go 1E, 2S, 1W, 1S, 4E, 3S, 2W, 1S, 2W, 2S, 1E, 1S, 1W to (23) on map and get ported to (24) on Level two.

Level two: From (24), go 3N, 1W, 1N, 2E to portal down at (25) to (26) on Level three.

Level three: From (26), go 1N, 3W, 2S, 1E, 1S, 2E and use Ferofist's Helm at (27). Go 2W, 1N, 1W, 2N, 3E, 1S to portal up at (26) to (25) on Level two.

Level two: From (25), go 2W, 1S, 3E, 1S, 1E, 2S, 2E, 1N, 1E, 1N, 1W to portal up at (28) to (29) on Level one.

Level one: From (29), go 1S, 3W, 2N, 2E, 1N, 2E, 3N, 4W, 2N, 1E, 1N, 1W to stairs down at (22) to (21) on Level two.

Level two: From (21), go 2S, 4E, 1S, 2E, 1S, 5E, 1S to portal down at (30) to (31) on Level three.

Level three: From (31), go 1S, 1E, 1N and use Werra's Shield at (32). Go 1S, 1W, 3N to door that is now visible at (33). Save the game. Go 1N and fight battle at (34). Go 2W, 4N, 3E, 2S, 2W and save the game at (35). Go 1N to (36) and fight Red Beard and friends. (Have the Bard sing Ministral Shield, while Spellcasters cast DIVA and NUKE; sneak your Rogue up to kill Red Beard, and have Fighters use Strifespears on Vortexes). Go 1N to (37) and get ported to Tarjan Dungeon.

Tarjan Dungeon

Go 4N, 5E, 5S, 4W, 4N, 3E, 3S, 2W, 2N, 1E and save the game. Go 1S and fight Tarjan and friends. There are several battles, with no time to realign your party. Use the tactics from the Red Beard battle.

Map Key: Bard's Tale III

Gelidia's Ice Keep, Level One

- 1 : In/out
- 2 : To Black Tower
- 3 : To White Tower
- 4 : To Grey Tower
- 5 : Circles, To Ice Dungeon

Sceadu's Dome, Level Two

- 1 : Portal up
- 2 : APAR from (1)
- 3 : Sceadu

Malefia

Level One

- 1 : In
- 2 : Strifespear
- 3 : Teleport to (4) on level three
- 9 : Portal down
- 10: Portal down
- 14: Portal down
- 15: Portal down
- 19: Portal down
- 20: Captive (use Alliria's Belt)
- 22: Stairs down
- 23: Teleport to (24) on level two
- 29: Portal down

Level Two

- 7 : Portal down
- 8 : Portal up
- 11: Portal up
- 12: Captive (use Sphere of Lanatir)
- 13: Portal up
- 16: Portal down
- 17: Captive (use Valarian's Bow)
- 18: Portal up
- 21: Stairs up
- 24: Teleported from (23) on Level one
- 24: Portal down
- 25: Portal down
- 28: Portal up
- 30: Portal down

Level Three

- 4 : Teleported from (3) on Level 1
- 5 : Captive (use Sceadu's Cloak)
- 6 : Portal up
- 26: Portal up
- 27: Captive (use Ferofist's Helm)
- 31: From (30) on Level two
- 32: Captive (use Werra's Shield)
- 33: Door (not visible at first)
- 34: Battle
- 35: Outside Red Beard battle
- 36: Red Beard and pals
- 37: Teleport to Tarjan

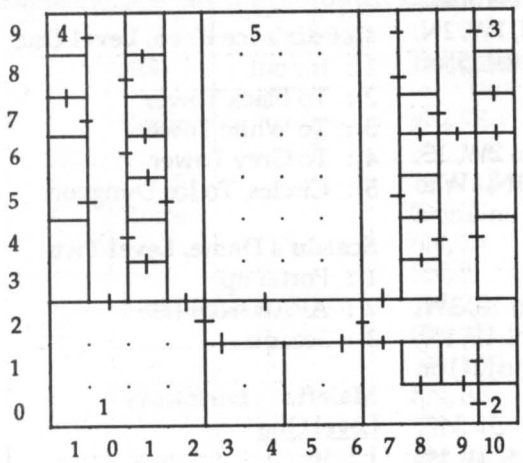

Gelidia: The Ice Keep, Level One

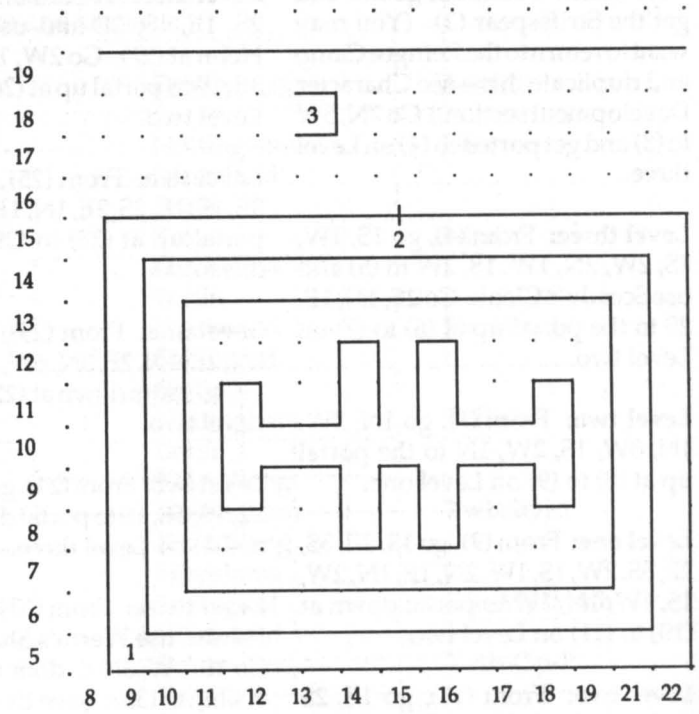

Scedu's Dome, Level Two

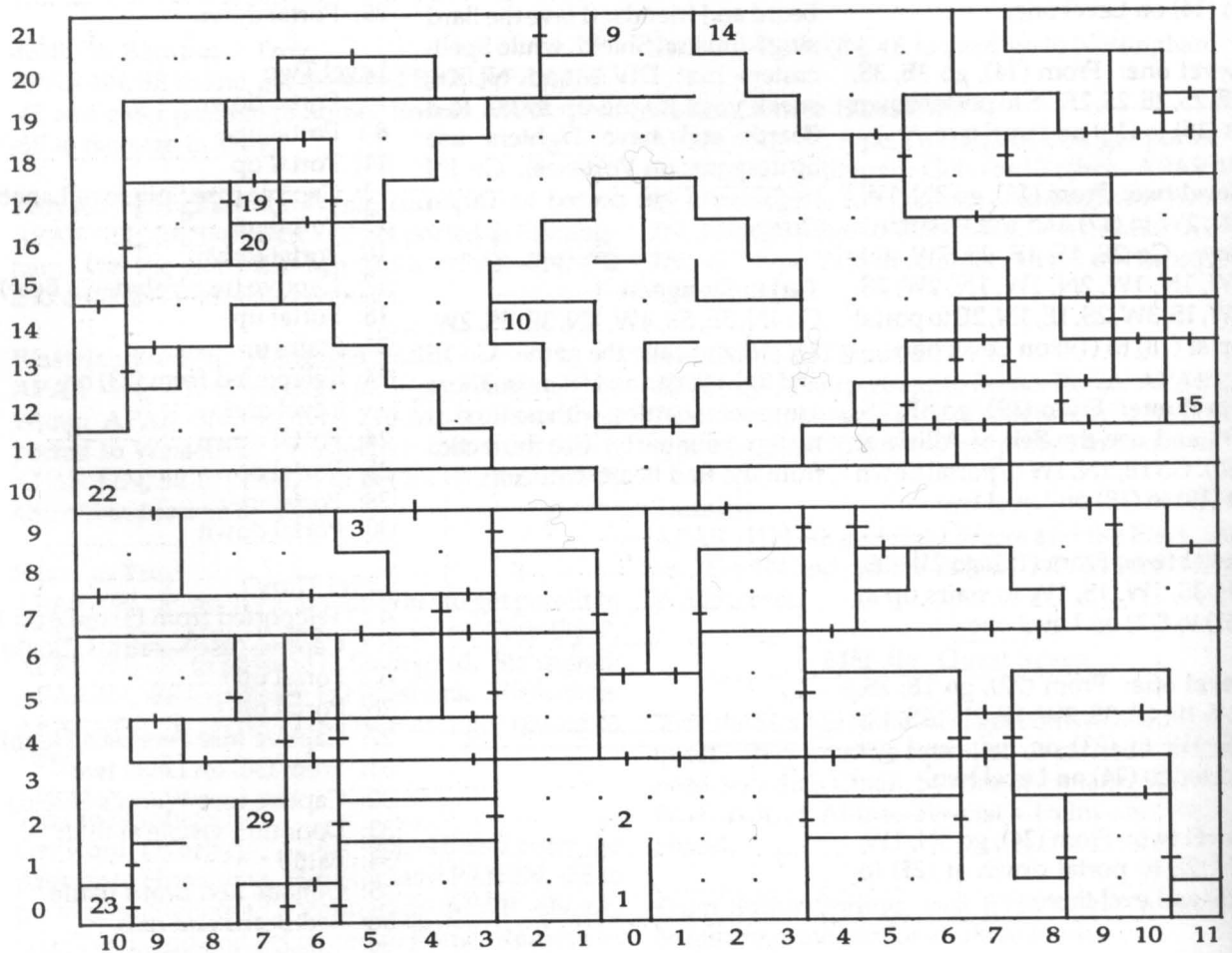

Malefia: Level One

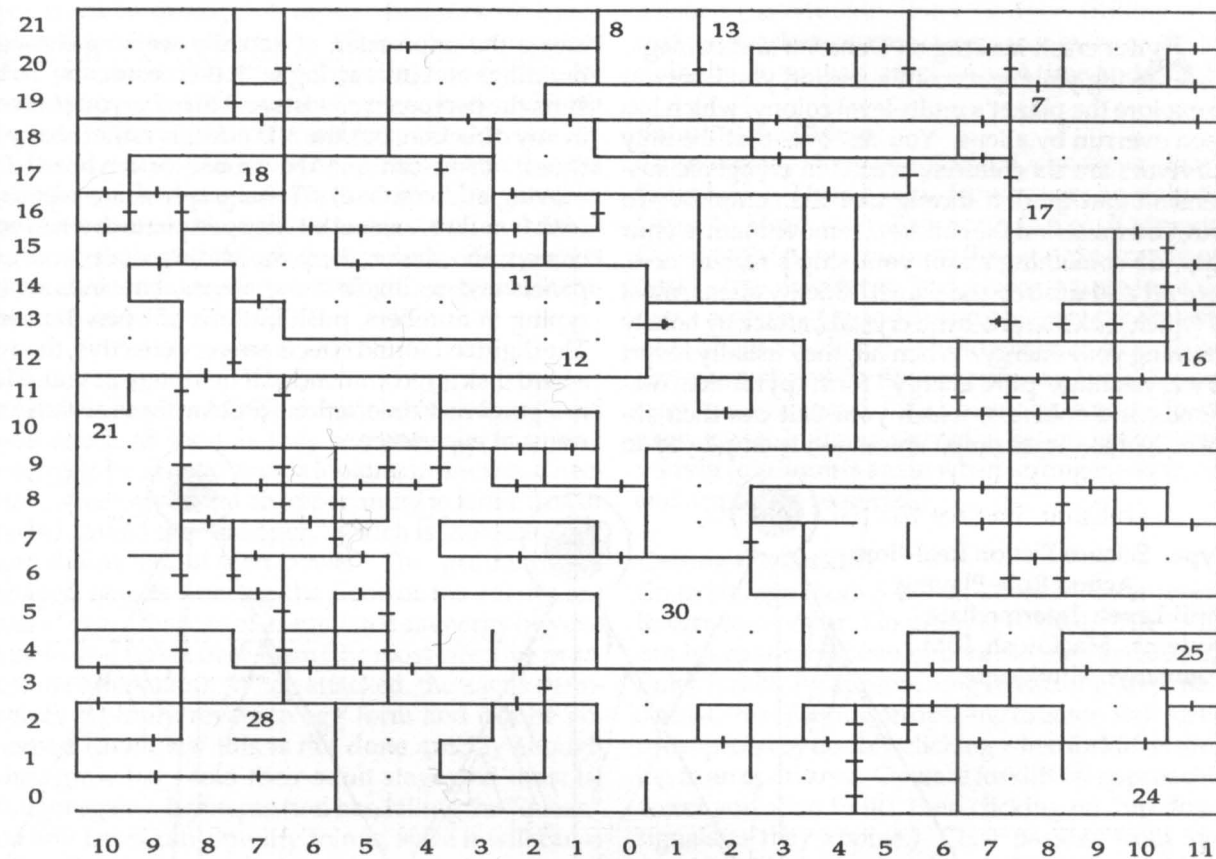

Malefia: Level Two

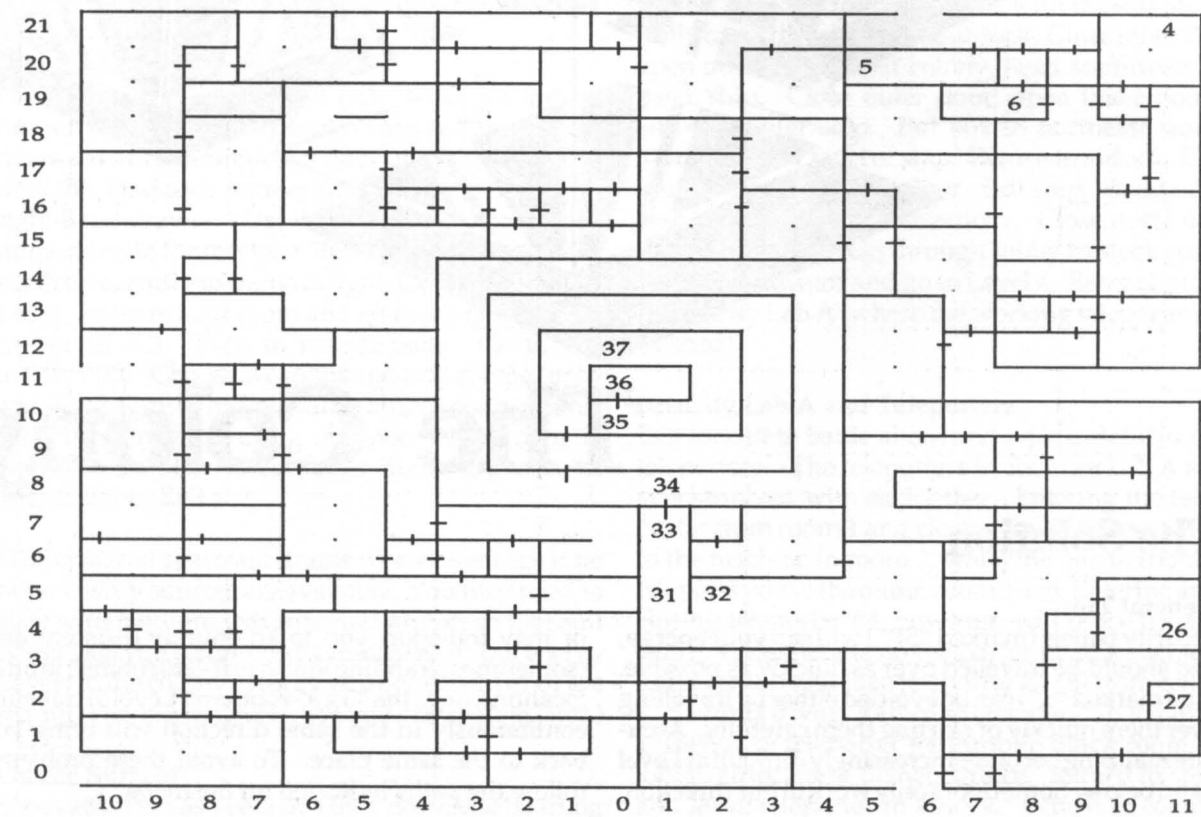

Malefia: Level Three

After crash-landing on Delta 5-5 and damaging your spacecraft's reactor, you'll set out to explore the planet's multi-level colony, which has been overrun by aliens. You discover that the only survivors are six children, placed in cryogenic suspension and hidden throughout the complex. To win, you must find the children, remove them to your ship, do something about your ship's reactor core, take off and destroy the planet. Enemy aliens, most of which look like one-eyed crystals, attack by noisily draining your energy. When hit, they usually revert to a crystalline "pure energy" form (pyramids, diamonds and spheres), which your suit can then absorb. Three-dimensional animation is employed to

create the impression of actually walking through buildings and interacting with their contents. To be sure, the perspective twists and turns as you proceed in any direction, but the 3-D effect is rather shaky at times. (You can use the mouse or keyboard for moving and combat.) These graphics are replaced with two-dimensional bit-mapped pictures when you come upon desks, dressers, sliding doors, control panels and so on; in these scenes, you interact by typing in numbers, push buttons or open drawers. The digitized sound effects are very effective, though a hard disk is recommended if this interests you. This is a good real-time action RPG for those seeking an unusual experience.

Type: Science Fiction Real-time
Action Role-Playing
Skill Level: Intermediate
Systems: Macintosh, IBM
Company: Mindscape

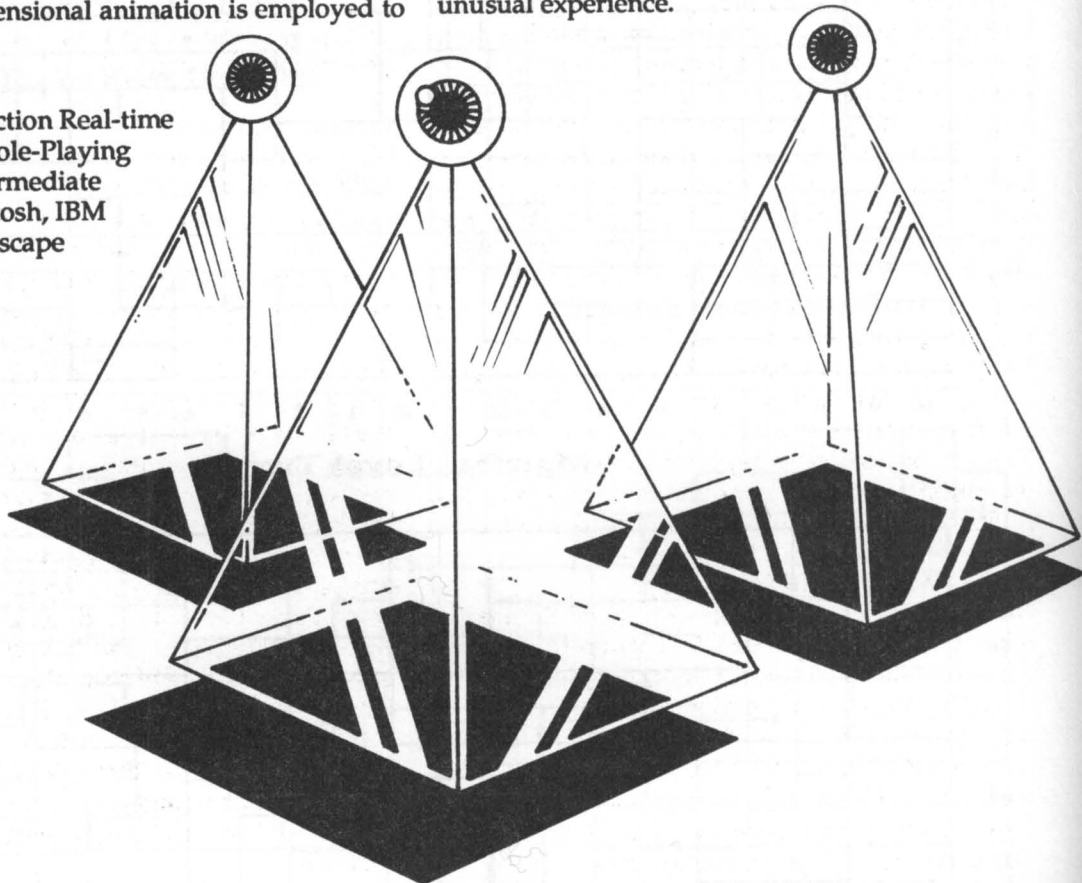

The Colony

The Solution

General Tips

Security panels (marked "SP") will sap your energy, and should be travelled over as quickly as possible. Pits (marked "x") can be avoided either by travelling over them quickly or skirting them carefully. Accurate mapping becomes increasingly difficult at Level 4 and below. Some doors only work in one direction,

or may transport you to an entirely different area (sometimes stranding you in exit-less rooms); in other locations, (e.g., the "3x3" rooms on Level 5) traveling continuously in the same direction will bring you back to the same place. To avoid these problems, follow the paths indicated on the maps.

In order to enter a teleporter while using the forklift, you must be **dbsszjoh b mpbe**. Just pick up boxes from the cruiser or colony. (This solution requires that you do so, because teleporting saves time by avoiding combat that ensues if you go back and forth by foot.) Plan your trips to and from the ship via teleporter to ensure you have enough boxes and that the position of the airlock doors is correct. It's possible, with a lack of forethought, to trap yourself in the ship because the outer airlock door is open. Teleporters are only mandatory for obtaining Cryogenic Chambers #4 and #5.

Combat

"Adult" aliens roam the colony laying "eggs," and will attack as soon as they see you, sapping your energy (often their "eye" is looking in another direction, which gives you an opportunity to strike first or hide.) Avoid the "snooper," which is indestructible and drains half of your power. The geometrically shaped objects littering the floor of the colony are alien "eggs" that can be assimilated as energy by your suit as you travel over them (the most effective process of elimination). When attacked, the aliens themselves typically revert to egg form and can be absorbed (though if this is not done quickly enough they grow back into their adult stage and must be fought again). If you can find her, killing the "queen" on any Level can simplify things, since it will cause virtually all aliens on that Level to enter the egg state. This can be especially important when traveling in the forklift, which cannot push the aliens aside and prevents you from returning their fire when attacked.

In the DAS Armored Cruiser

Go to central control panel (A). **Uvso po mjhiut** (button on upper left of panel). Turn and head south down corridor through last door on right. Examine desk (B). Find code for reactor control panel in lower right-hand drawer. (Use decoder card to determine numeric code for reactor.) Exit room and head back north up corridor to stairs on right. Go down to lower Level. Enter reactor room and go to the reactor control panel (C). Type in reactor code. Go to suit installer (D). Choose weapons and armor type (preferably medium or heavy). Go to airlock control panel (E). Type in code, using decoder. Open door to airlock and enter. Close inner door. Open outer airlock door. Exit ship.

(The armored spacesuit drains wearer's energy if no other energy sources are available. You may need to start with medium weapons and armor, so that suit doesn't kill you before you have increased your energy Levels in the colony. Heavy weapons and armor are required on lower Levels, but you can change later.)

On the Surface

Shoot attackers as needed. Head northeast (skirting

obstacles) until you see a block-shaped outline with a door on its **xftu** side. Enter the door. (Killing all the surface attackers is unnecessary to win the game, and trying to do so may simply waste time and energy.)

Entering the Colony

Close outside door of airlock. Open inner door. Enter lobby. **Uvso opsui**. Down stairs on right to Level 1. Head west then north to Col. Radmer's Office with (A) reactor code (lower right drawer of desk). Use decoder to find numeric code for colony's reactor. Go to (B) projection room (to see slide show on aliens). Go to elevator (C). Take elevator to Level 5. (Before entering Level 5, you may need to spend time absorbing energy from alien eggs to build up strength. Return to ship and **vtf tvju jotubmmfs** again when stronger weapons and armor are required.)

Getting the Forklift

Go to storage room 5 (A) on Level 5. Enter forklift. Return to elevator. Go to Level 1. (Note: The forklift can **hp epxotubjst cvu opu vq**, so plan accordingly. Enter forklift by approaching it, clicking on panel to open it, then clicking on opening to enter. Exit forklift or drop load by double-clicking when forklift is standing in an open area. Operate forklift by approaching object you wish to lift, then clicking on "up-down" signals as they appear.) Clear passage from Stock room to lobby by moving boxes (D). (When returning to the ship with an empty forklift, repeat this sequence, since you can't enter a teleport unless the forklift has a load: take any box with the forklift and go through the lobby to the airlock. Close inner door, open outer door. Exit colony, head southwest and enter ship. Close outer door, open inner door of airlock. Enter ship. Put box in northeast storage room on lower level of ship. Return to airlock. Close inner door, open outer door. Exit ship. Head northeast to colony and enter airlock. Close outer door, open inner door. Go through lobby to stock room.) Return to elevator and go to Level 4. Enter chute (A) to Security Lab A (where the working teleporters are stashed).

Security Lab A and Teleporters

Exit forklift to battle aliens and **wjfx tmjef tipx** on teleporters. (The teleporters in Security Lab A are synchronized with each other. Entering the teleporter from room 1 and closing it will teleport you to the machine in room 2, while the one in room 2 teleports you to the one in room 3, etc. Entering and closing teleporter #4, however, will cause instant death, since there is no teleporter #5 to travel to.) Enter forklift and take teleporter #4 (B) from room 4. **Sf-foufs divuf**. Return to elevator. Go to Level 1, then take teleporter #4 through Stock room to lobby, airlock and planet surface. Return to ship and leave teleporter in airlock. Return to colony

and Security Lab A, as before. Take teleporter from room #2 (C). Enter teleporter #3 (D). Close door (thereby teleporting to #4 in ship's airlock). Exit #4 and close outer door of airlock. Open inner door and take teleporter #2 to DAS cruiser's reactor room. Drop teleporter #2. Return to airlock and pick up teleporter #4. Take teleporter #4 to reactor room (closing inner door of airlock from inside). Drop it. Return to airlock, close inner door, open outer door and exit to surface. Return to colony, traveling northeast. Enter Colony.

Saving the Children

Cryogenic Chamber 1

Go (via stock room) to Security area on Level 1. Go to easternmost cell in Security and take Cryogenic Chamber #1 (1) with forklift. Return to Security Lab A via elevators and chute. Enter and activate teleporter #1. Exit teleporter #2 (in ship's reactor room). Take Cryogenic Chamber #1 to forward storage area of ship's lower Level, and leave there. Get box from northeast storage room on lower deck. Sfvuso up sfbdups sppn. Enter and activate teleporter #2. Exit teleporter #3 (in Security Lab A). Drop box.

Cryogenic Chamber 2

Take chute and elevator to Level 3. With forklift, get Cryogenic Chamber #2 (2) from Level 3. Return to Security Lab A via elevators and chute. Enter and activate teleporter #1. Exit teleporter #2 in ship's reactor room. Place Cryogenic Chamber #2 in gpsxbse tupsbhf bsfb. Get box from northeast storage room on lower deck. Return to reactor room. Enter and activate teleporter #2. Exit teleporter #3 in Security Lab A. Drop box.

Cryogenic Chamber 6

Return to Level 4 via chute (F) and get Cryogenic Chamber #6 (6) with forklift. (To escape the maze, go north through the door at (B), then jnnfejbufmz hp tpvui through the same door, which teleports you to (C) on Level Four. If you keep hpjoh opsui after entering (B), you'll wind up in an endless labyrinth.) Return to Security Lab A. Enter and activate teleporter #1. Exit teleporter #2 in reactor room and place Cryogenic Chamber #6 in forward storage area with others. Get box from northeast storage room on lower deck. Return to teleporter #2, entering and activating it. Exit teleporter #3 in Security Lab A. Drop box.

Cryogenic Chamber 4

With forklift, take teleporter #1 to Level 5. Enter central chamber (4) in the "3 x 3" area. (There are op fyjut, so you *must* csjoh b ufmfqsufs with you.) Drop teleporter #1. Pick up Cryogenic Chamber #4.

Enter and activate teleporter #1. Exit teleporter #2 in ship and place Chamber #4 with others. Get box from northeast storage room on lower deck. Return to reactor room, entering and activating teleporter #2. Exit teleporter #3 in Security Lab A. Drop box.

Cryogenic Chamber 3

Use the forklift to take teleporter #3 to Lab 1 on Level 4, then go to (3). Drop teleporter #3 and pick up Cryogenic Chamber #3 (3) with forklift. Enter and activate teleporter #3. Exit teleporter #4 in ship's reactor room and place Chamber #3 in forward storage area with others. Get box from northeast storage room po mpxfs efdl. Return to reactor room, entering and activating teleporter #2. Exit teleporter #3 in Lab 1. Drop box. Pick up teleporter #3 with forklift and exit Lab 1. (If you lack sufficient energy to traverse the Security panels and exit Lab 1, you can replenish your supply beforehand by sfvsojoh "po gppu" from the ship to the colony and absorbing alien eggs.) Carrying teleporter #3, take elevator to Level 5. Go down stairs (Y) to Level 6.

Cryogenic Chamber 5

Drop teleporter #3. Get Cryogenic Chamber #5 on Level 6 with forklift and return to teleporter #3. Enter and activate teleporter #3. Exit teleporter #4 in ship's reactor room. Put Cryogenic Chamber #5 in forward storage area with others.

The Ship and Colony Reactors

Return to DAS Cruiser's reactor room. With forklift, pick up sfbdups dpsf, (shutting down all the ship's power). Enter, espq reactor core and activate teleporter #2. Exit and pick up teleporter #3 on Level 6. Take stairs to Level 7. Take stairs to sfbdups Mfwfm. Enter reactor room (A) and drop teleporter #3. Exit forklift. Type code into reactor's control panel (B). Enter forklift. Take reactor core with forklift. Enter and activate teleporter #3. Exit teleporter #4 in ship's reactor room. Put colony's reactor core in qmbdf pg pme sfbdups dpsf. (Do not espq ju bozxifsf fmf, or it will shatter.) Exit forklift. Type code into control panel (C). Exit reactor room and remove armored suit (D). Return to command station and push levers on far left of control panel (A) for takeoff. Once in space, press upper right button on control panel to destroy planet. (Don't try to kill the Queen at the reactor. Clear as many fiends as possible, enter the code, go back for the forklift, get the reactor and ufmfqsu pvu.)

Map Key: The Colony

SP: Security panels
X: Elevators

DAS Armored Cruiser

A: Central Control Panel
B: Code for Reactor Panel
C: Reactor Control Panel
D: Weapons
E: Airlock Control

Level One

A: Colony reactor code
B: Alien slide show
C: Elevator
1: Cryogenic Chamber 1
S: Stairs up and down

Level Two

S: Stairs up and down

Level Three

2: Cryogenic Chamber 2
S: Stairs up and down

Level Four

S: Stairs up and down
3: Cryogenic Chamber 3
6: Cryogenic Chamber 6
A: Chute to Security Lab A
B: Door that teleports you to (C); see solution
C: From teleport at (B)

Level Five

A: Forklift
4: Cryogenic Chamber (4 no exits—must take teleporter in with you)
Y: Stairs to Level 6
S: Stairs to Level 4

Level Six

5: Cryogenic Chamber 5
U: Stairs up to Level 5
D: Stairs down to Level 7
C: Chute to Security Labs

Level Seven

A: Stairs down to Reactor
B: Up to Level 6
x: Pits

Reactor Level

A: Reactor
B: Reactor Control Panel

Security Lab A

A: Slide show
B: Teleporter 4
C: Teleporter 2
D: Teleporter 3
E: Teleporter 1
F: Chute to Level 4

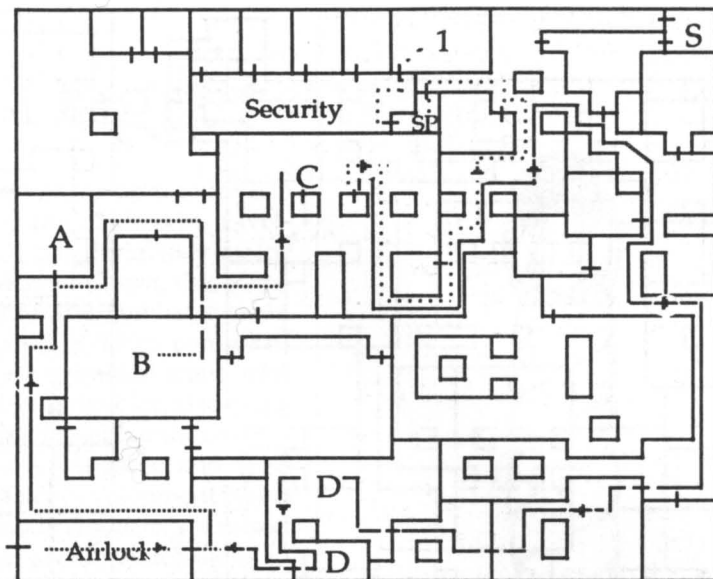

Level One

----- Coming from DAS first time
..... To get Cryo Chamber 1
———— Moving Boxes, taking Teleporter 4 to ship

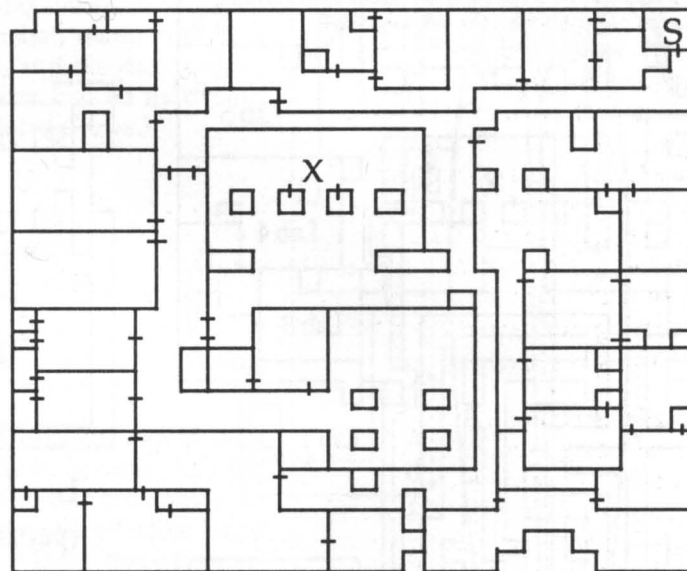

Level Two

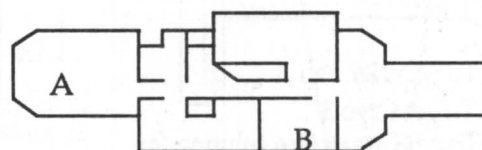

Upper Level

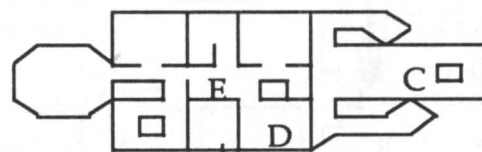

Lower Level

DAS Armored Cruiser

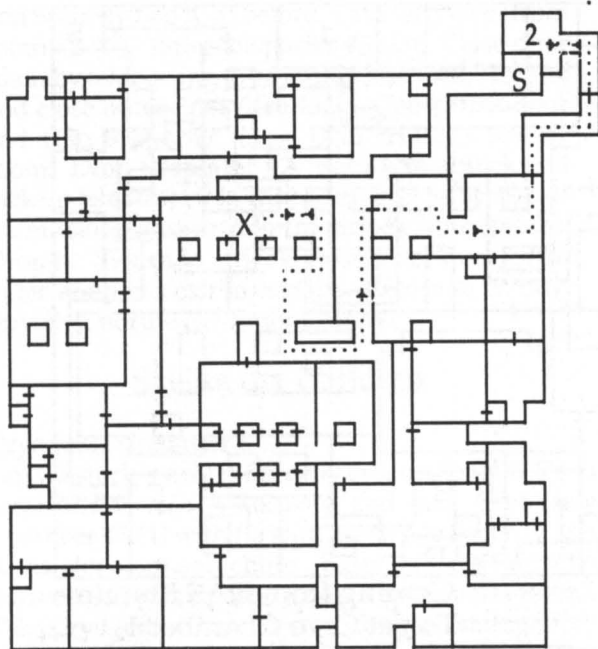

Level Three — To get Cryo Chamber 2

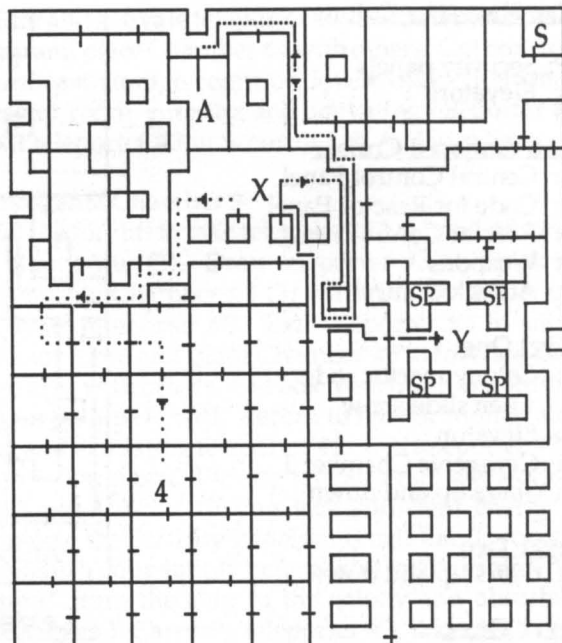

Level Five To get Forklift
 — To get Cryo 4
 — To Level 6 stairs

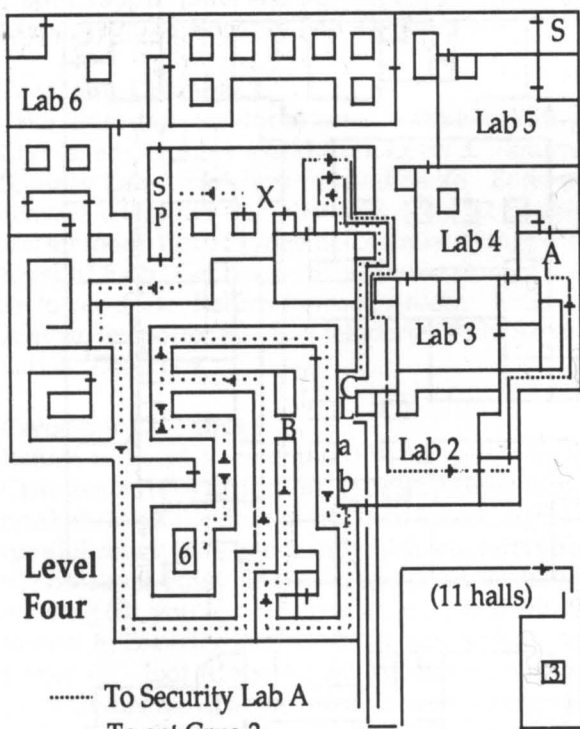

Level Four

..... To Security Lab A
 — To get Cryo 3
 To get Cryo 6 (see solution for teleport route from maze to C)

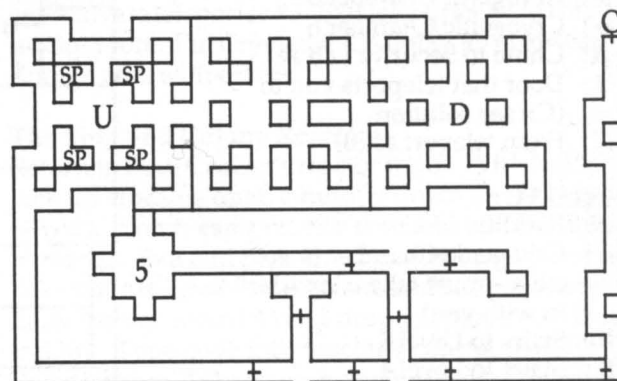
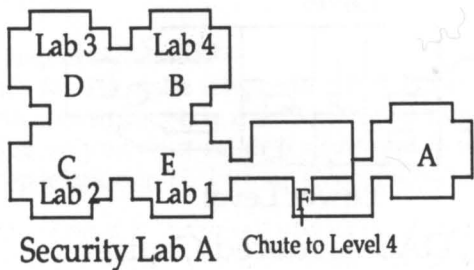

Level Six
 (partial map)

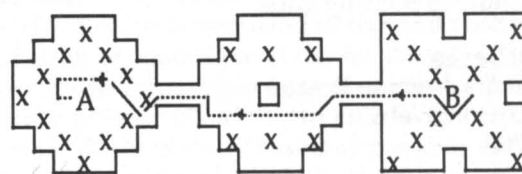

Level Seven To Reactor Level

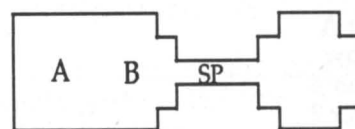

Reactor Level

The Eternal Dagger

Demons from a parallel universe threaten to invade your world, Arghan, and the only way to stop them is by traveling to Middle World and destroying the Demon Portal they use for interdimensional travel. A sequel to *Wizard's Crown*, this game employs the same strategy and tactics-intensive combat system. Three combat modes are available, from individual control of each party member (represented by semi-animated icons who move about a combat arena when you press various keys) to quick combat, an all-text variant in which the computer handles everything. The former mode is comparable to a war game, and these battles can last a half hour or more. Character development is also stressed, for your eight-man team can contain characters of mixed classes, such as Fighter-Priests, and you decide which skills to "spend" experience points on. Graphics are weak, sound effects basic, and there are relatively few puzzles to solve—so unless you enjoy tactical combat fought with swords and magic rather than tanks and machine guns, don't expect to have much fun in this fantasy world. But most aficionados of this kind of game agree that *Eternal Dagger* is far more playable and rewarding than its predecessor. It's easier to win quick combat, many annoying elements of the interface were upgraded, and the plot is more engaging. (Characters from *Wizard's Crown* can be used with *Dagger*, but don't do so unless they completed *Crown*.)

Type: Fantasy Role-playing

Skill Level: Advanced

Systems: C 64/128, Apple II (48K), Atari (48K)

Company: Strategic Simulations/Electronic Arts

The Solution

Character Creation and Training

You need one Thief and one Ranger. All others should be a combination of Fighter and one other class, because fighting conserves magic. Follow the manual's minimum recommendations regarding your characters' attributes. An effective party consists of one Fighter-Ranger, one Fighter-Thief, three Fighter-Sorcerers and three Fighter-Priests. You can get by with one pure Sorcerer and one pure Ranger.

Weapon Skills

Swords are the most damaging and also the most ubiquitous item, so give this skill to all Fighters. At least one should have Mace as his primary skill. For thrust-type skills, choose Spear over Bow. Choose Bow over Crossbow, because Bows don't need to be loaded alternately. However, Bow skills aren't too bad, so if you like using them go ahead and make it a Fighter-Ranger's primary weapon. Forget Shield skills, except for pure Sorcerers.

Hunting for Food: The Ranger

Much depends on your Fighter-Ranger (or Ranger-Priest, etc.), for he needs skills in Scan and Stealth in order to avoid ambush. He also needs to be good at Tracking, to obtain treasure. Most important, he must be a top-notch Hunter in order to obtain food. Priority in allocating experience points for Rangers should be Hunt, Scan/Stealth and Track.

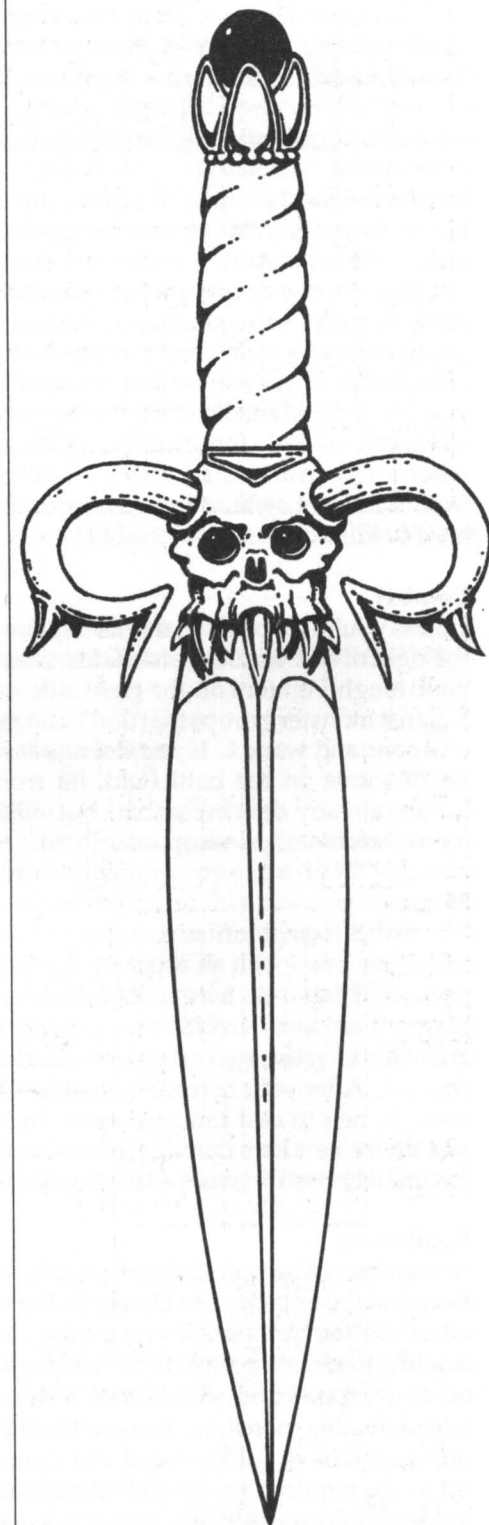

Skill Development

Synonymous with Speed, Dexterity is the game's most important factor. It is the sole defense against monsters with high Dexterity. Have Priests concentrate on Cure Disease, Treat Poison and Turn Undead. Later on, two Priests should also build up their Turn Undead skills. Karma should not be neglected.

Combat, Magic & Equipment

Before the Battle

Never forget the Fatigue factor before deciding to enter combat. And the display doesn't tell you whether it's day or night when you encounter monsters, so make sure you know, because only two of your characters wear armor at night. Beware of the (S)urrender key, because you'll lose all your gold if you hit it accidentally. After your characters are advanced enough, forget about fighting wolves and other common animals worth few points. Stay away from trees and swamp things, which are extremely hard to kill.

Combat

Unless you're ambushed, monsters always appear to the right of all Outdoor battlefields. Therefore, place your tough Fighters on the right side of the screen. Against monster groups that don't cast magic, rely on weapons and wands. If you flee and leave someone unconscious on the battlefield, he won't be killed (unless already slain in combat), but will be robbed of money and magical weapons.

Magic

Get five Blessings off as soon as possible, and few monsters can touch your party (except for Magic users, and that's all there are at the advanced stages). Magic Blast and Fireball are very useful. Others aren't too effective against powerful monsters, which abound. After your Sorcerer's Cast Spell skill is high enough, he can cast multiple spells in a single turn and do tremendous damage to the enemy (who unfortunately has the same advantage).

Equipment

Always have a lockpick when entering any dungeon. Examine the appropriate Dungeon Prerequisites for other vital equipment. To save time, do this before heading for the dungeon. Don't waste gold on equipment, weapons and so on: You'll find better ones after defeating monsters. You can't enchant weapons unless you have gold in hand, not change that adds up to the required price. Don't enchant equipment unless you're certain it's your final piece of gear, Drain Proof Plate Armor and Flaming Greatsword, for example. Carry bandages: First aid won't make injuries worse as it does in *Wizard's Crown*.

Numbers correspond with those on the appropriate

dungeon map; letters on the outdoors map, to the letters of the dungeons as described in the game disk's Utility section.

The First Island

Head for the only Temple/Town on the island and fight off/run from the monsters guarding it. Stay in the area until your characters can handle the Undead effortlessly, then march on the Rebel Base. Try to avoid the island's southeast quadrant and swamp/forest east of the town's swamps, the lair of the Dragon. Unless your characters are faring very badly and need more magical weapons, don't fight the monsters at the treasure areas shown on the map; they'll still be there after the island returns to normal. Meanwhile, you can't sell anything because the island is still enchanted; furthermore, your carrying capacity is severely limited.

The only weapon you can get without a fight is the Dragonslaying Sword from the Rebels: (T)alk to them. Get it immediately, because the Rebels and Sword vanish after the island returns to normal. If your party can hold out, don't get the Holy Morningstar from the Dragon's horde until after the Necromancer is destroyed, for the horde contains a great treasure you can sell later on. But this Morningstar is the most effective weapon against the Necromancer, so you may want to go ahead and grab it.

Dungeon A: Necromancer's Cave, Level 1

Prerequisites: Dragon's Teeth (for Level 2) if you have slain the Dragon. You can also buy them in this dungeon for ten Life Forces each. This dungeon cannot be entered after you destroy the real Necromancer, so take only the best equipment you can find.

Search the island's northwest tip for the tunnel to the Necromancer's island. Inside the dungeon, your party appears at the stairs on the northwest corner of the map. (1) The door's name: **xoqu**. (2) The floor's name: **jym**. (E)xamine at (3) to open the door. In (4) you find the false Necromancer and a necklace. (5) Dragon's Teeth are sold here. (If you buy them, return to the Temple to restore Life Forces before continuing.) Head for the stairs at (6).

Dungeon B: Necromancer's Cave, Level 2

Your party appears at the north central part of the map. (1) Use the Dragon's Teeth. The chests at (2) contain only spices and bandages. (3) Remember the door's name? **xoqu**. At (4), you need the floor's name: **jym**. (5) To learn hall's name, each character must pay 20 Life Forces. Speak hall's name (**spmg**) at (6), enter and fight the real Necromancer (7).

Outdoors Again

When the Necromancer is destroyed the island changes. Go to town, sell your treasures, then get all

the remaining treasures depicted on the map. Buy passage to Elven Isle (in town).

Elven Isle

To save time, visit dungeons in the following order.

Dungeon E: Magoomba's Grove

No map is provided, since there are no walls. You've got to be quite powerful to take on Magoomba, but vanquish him and you'll get the Living Dagger. (Lightning and Magic Blasts are effective.)

Dungeon H: Dungeon of Koruy

Your party appears dead-center of the map. (1) Examine this spot for skeleton key. It's not necessary to go to (2) unless you want money. To open the door into (2), pull the lever at (3). Use the skeleton key from (1) to release the Princess at (4). She'll turn the Living Dagger into the Eternal Dagger.

Dungeon G: Waddling Turtle's Hut

No map is necessary for this maze. Turtle will give you a map for Dungeon F if you rescued his daughter.

Dungeon F: The Aerie

Prerequisites: A 50-foot rope.

Upon seeing map (from Turtle), Gray Eagle will give you Bag of Winds, the only way to enter Avlis' Tower.

Dungeon C: Avlis' Tower, Level 1

Prerequisites: The Bag of Winds (from the Aerie) and 20 copper pieces. If you have both, save game at this point—but not in the dungeon, since you can't escape it until completing both levels. (If you lose the Bag of Winds after doing everything up to Dungeon G above, return to Dungeon F and you'll get another one.)

Your party appears in the southeast corner of the map. At (1) you must pay up. You'll find a +7 Greatsword at (2). The answer at (3) is *tfwfo*. If you can't unscramble the puzzles at (4), the answer is *uifff kftufst gsjhiufo fbtjnz*. It's a hint for the most effective spell to use in the next room. The answer at (5) is gorillas. Pull the lever at (6). This room is meant to intimidate you. Just move back and forth and the doors will open. Go up the stairs at (7).

Dungeon D: Avlis' Tower, Level 2

Get the Bag of Winds at (1) if you want to return to this place. The goal here is to get the Feathered Cloak at (2) and escape the maze. To escape, go south past the statues at (3), close all the doors (except the one immediately after you pass the three statues on the way to this maze) and enter the flame (4) in the square room. Don't pass through *boz gmbnf* twice or your characters will be injured and teleported to the stairs.

Here's what happens if you follow the advice of the three statues at (3). Left statue: You're teleported to

the stairs at the northwest corner of this dungeon. Middle statue: Teleports you to the dungeon's southwest corner. Right statue: You'll exit the tower.

Dwarven Island

Dungeon I, Sri's Lair, is in the center of the island, approached from the south. You don't need to talk to the natives for clues. Fight the Dwarven Patrol when you meet them. Dwarf soldiers are the best source of treasure and magic items. It costs one gold piece to enter the Temple and ten to return to the Elven Island, so plan your buying and enchanting accordingly. Monsters are extremely tough, so don't wander too far on your first day here.

Dungeon I: Sri's Lair

Prerequisite for Level 3: Enough space for *uisff jufnt*. Holy Weapons +5 are useful on all levels.

Level 1

You'll find copper pieces at (1). If you mine for silver at (2), your crew will become exhausted. Take stairs at (3) to Level 2.

Level 2 (labeled Dungeon J)

You'll find silver at (1) and stairs to Level 3 at (2).

Level 3

Get the Dwarven Helmets at (4).

The Elven Isle

Return here after obtaining the eight Helmets. Save the game here and make a copy of the disk if you want to continue adventuring on this plane, because you *dbo'u uvso cbdl bgufs* visiting Grey Eagle. Also remember to heal all wounds and visit the Temple before going on. If you have the Feathered Cloak and the Eternal Dagger (preferably enchanted to +6), go on to Dungeon F, The Aerie, again; Grey Eagle will fly you to the next maze.

Above the Underwater Dungeon

Rest here. There's nothing else to do but search. Wear the helms.

Dungeon K: Underwater Dungeon (Enolho)

You'll get Wizard's Plate +6 at (1), though monsters are formidable. It's not necessary, but you can examine tables at (2) for an interesting message. The gate to the Demon World is at (3). You must drop all but the Eternal Dagger.

Dungeon L: Demon World

The maze configuration shifts due to rolling boulders, but there are only three variations. Follow the path mark by a-h on the maze maps. When heading toward the next boulder, avoid any other boulder in your path. If this is confusing, type these directions from (a): 7, 7, 7, 8, 1, 3, 3, R, 7, 7, 7, 7, R, 6, 6, 6, 5, 5, 4,

R, 5, 6, 6, 6, 8, R, 8, 8, 1, 1, 2, 4, 2, 1, 8, 1, 8, 6, 5, R, 3, 4, 6, 6, 5, 5, 5, 5, 4, 5, 4, 2, 2, 3, 2, 3, R, 2, 3, 3, 3, 3, 4, R, 7, R, 6, 5, 5, R, 3, 3, 4, stairs (1).

At (1) you get teleported to (2), when you must defeat the Lesser Demons and immediately go east. The teleport at (3) sends you to (4), where you move obliquely to (5) and get ported to (6). Move north after defeating the Vermin, and Elharra gives some advice at (7). Plunge the Eternal Dagger into the device at (8).

Map Key: Eternal Dagger

Dungeon A: Necromancer's Cave, Level 1

- 1 : Door's name
- 2 : Floor's name
- 3 : Door (examine)
- 4 : False Necromancer, necklace
- 5 : Dragon's Teeth for sale
- 6 : Stairs

Dungeon B: Necromancer's Cave, Level 2

- 1 : Use Dragon's Teeth
- 2 : Chests with spices and bandages
- 3 : Need door's name—xoqu.
- 4 : Need floor's name—jym
- 5 : Learn hall's name
- 6 : Need hall's name—spmg
- 7 : Real Necromancer

Dungeon E: Magoomba's Grove

No map is provided, since there are no walls. Magoomba and Living Dagger are here.

Dungeon H: Dungeon of Koruy

- 1 : Skeleton key
- 2 : Gold
- 3 : Lever that opens door into (2)
- 4 : Princess and Eternal Dagger.

Dungeon G: Waddling Turtle's Hut

No map is necessary for this maze. Turtle will give you a map for Dungeon F.

Dungeon F: The Aerie

Upon seeing the map (from Turtle), Gray Eagle will give you the Bag of Winds.

Dungeon C: Avlis' Tower, Level 1

- 1 : Pay up
- 2 : +7 Greatsword at (2)
- 3 : Answer is **tfwfo**
- 4 : Answer is **uifff kftufst gsjhiufo fbtjnz**
- 5 : Answer gorillas.
- 6 : Pull lever
- 7 : Stairs

Dungeon D: Avlis' Tower, Level 2

- 1 : Bag of Winds
- 2 : Feathered Cloak
- 3 : Statues
- 4 : Flame (exit)

Dungeon I: Sri's Lair

Prerequisite for Level 3: Enough space for three items. Holy Weapons +5 are useful on all levels.

Level 1

- 1 : Copper pieces
- 2 : Silver
- 3 : Stairs

Level 2 (labeled Dungeon J)

- 1 : Silver
- 2 : Stairs to Level 3

Level 3

- 4 : Dwarven Helmets

Dungeon K: Underwater Dungeon (Enolho)

- 1 : Wizard's Plate +6
- 2 : Message
- 3 : Gate to the Demon World

Dungeon L: Demon World

- 1 : Stairs
- 2 : Lesser Demons
- 3 : Teleport
- 4 : Teleport destination from (3)
- 5 : Teleport to (6)
- 6 : Vermin
- 7 : Elharra
- 8 : The device (use Dagger)

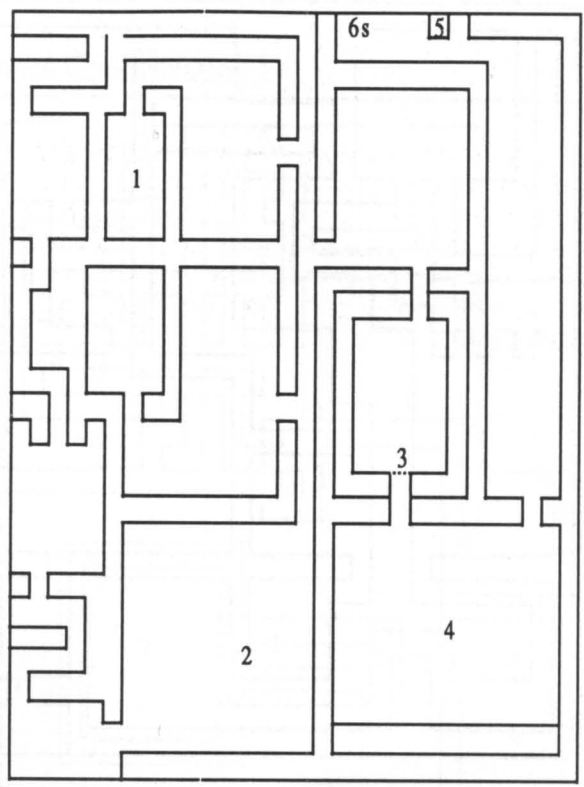
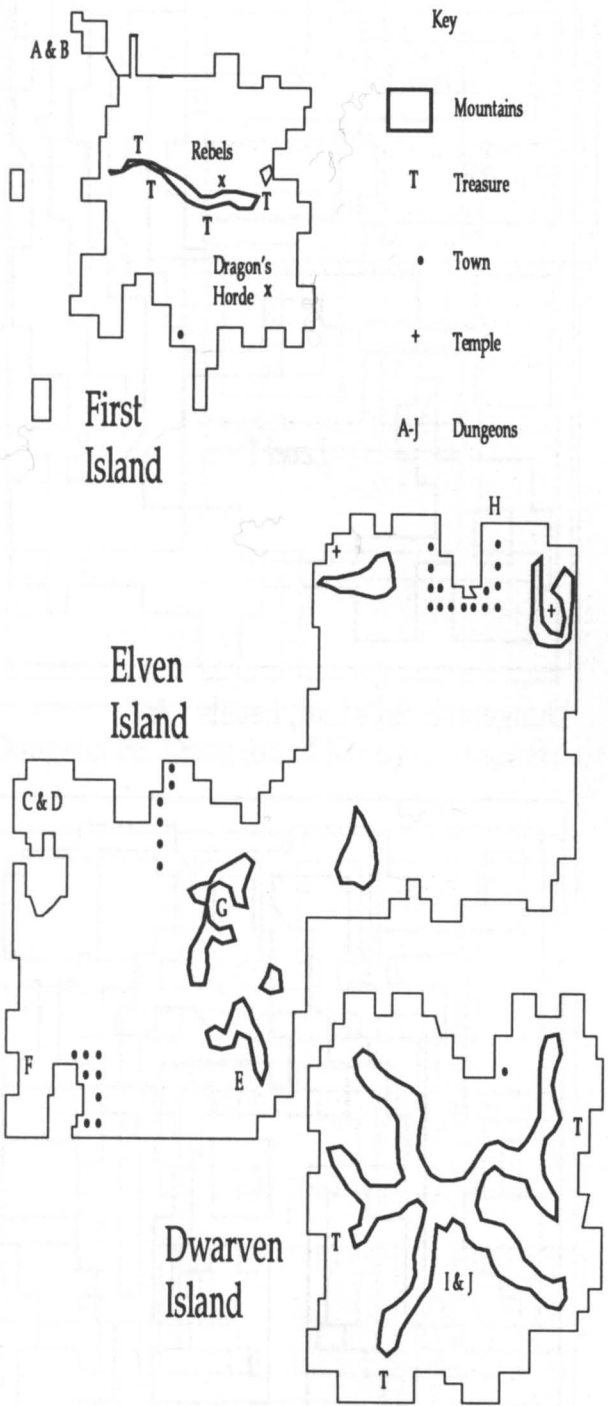

Dungeon A: Necromancer's Cave, Level 1

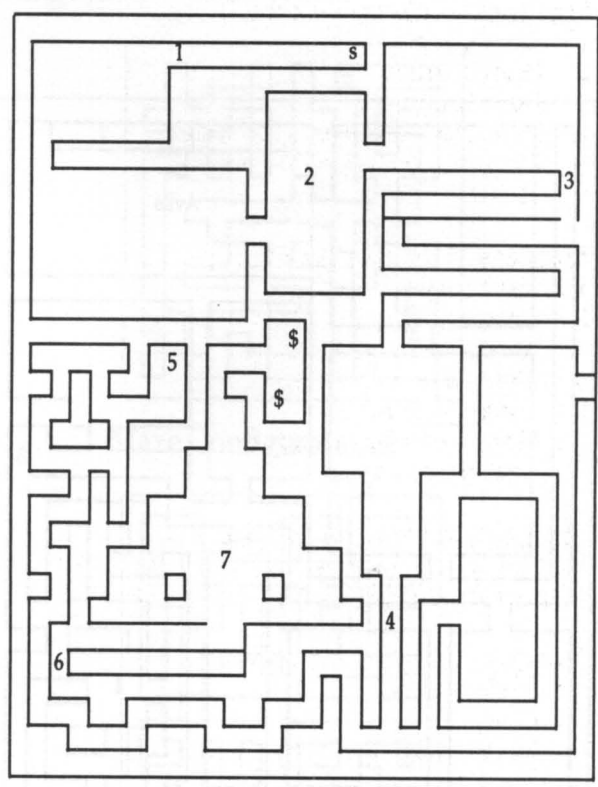

Dungeon B: Necromancer's Cave, Level 2

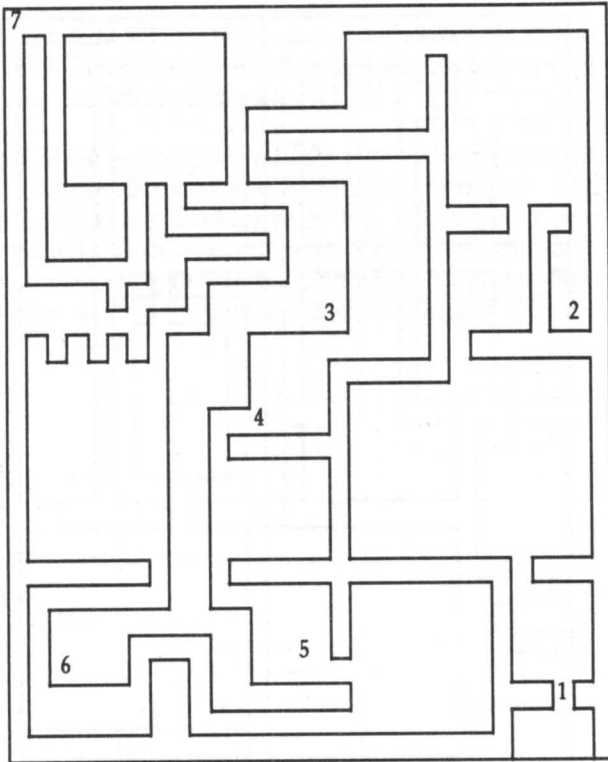

Dungeon C: Avlis' Tower, Level 1

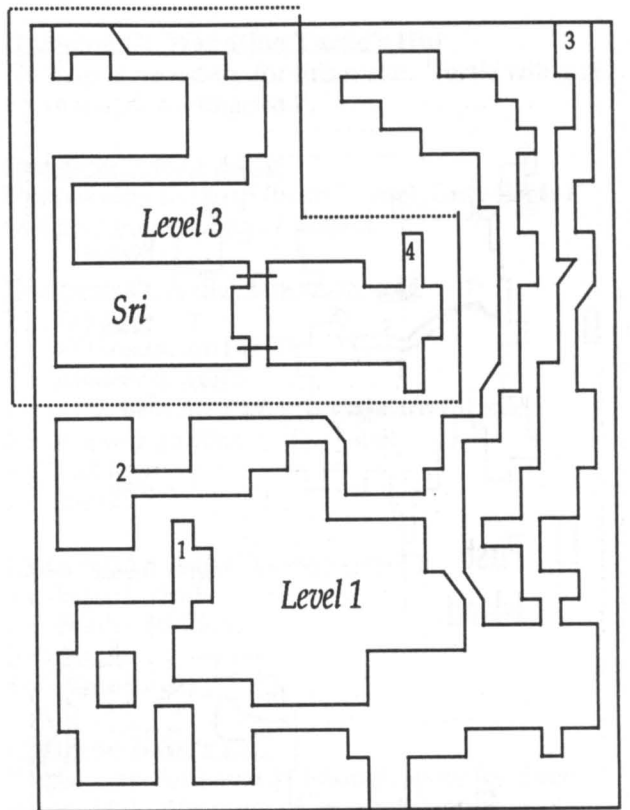

Dungeon I: Sri's Lair, Levels 1 & 3

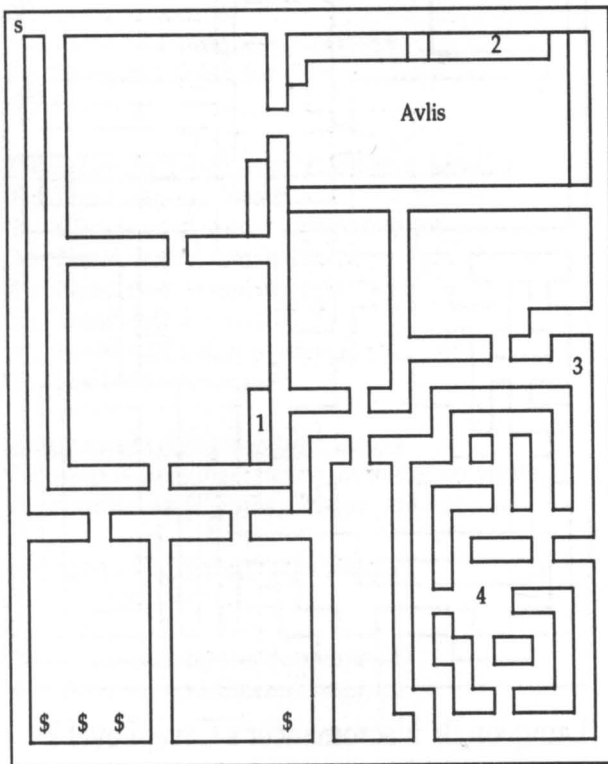

Dungeon D: Avlis' Tower, Level 2

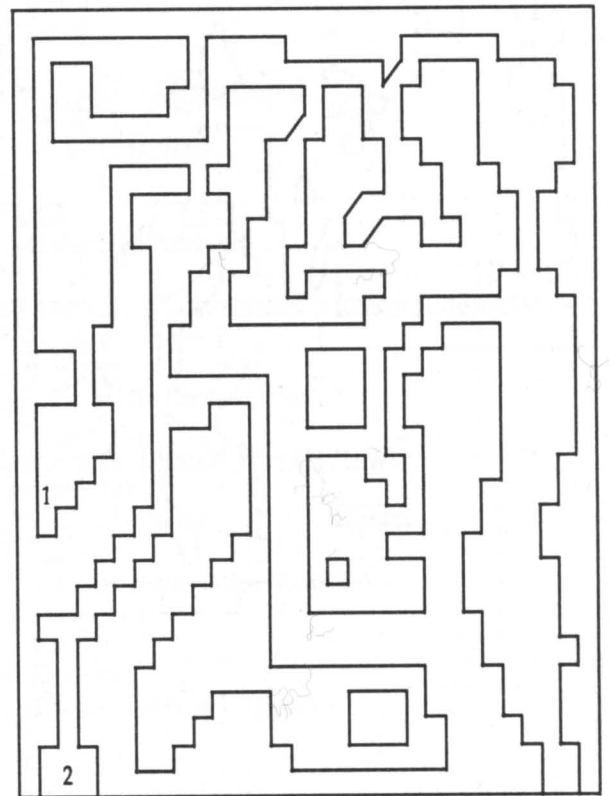

Dungeon J: Sri's Lair, Level 2

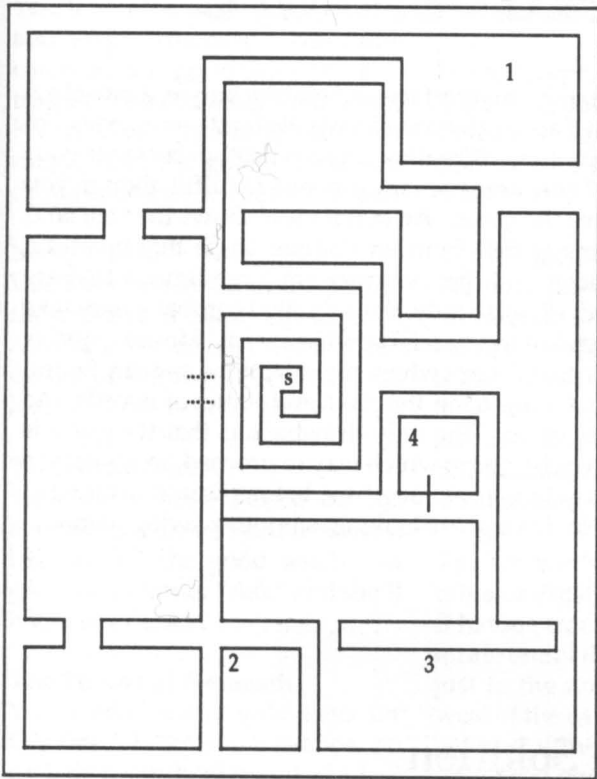

Dungeon H: Dungeon of Koruy = secret door

Maze Configuration 1

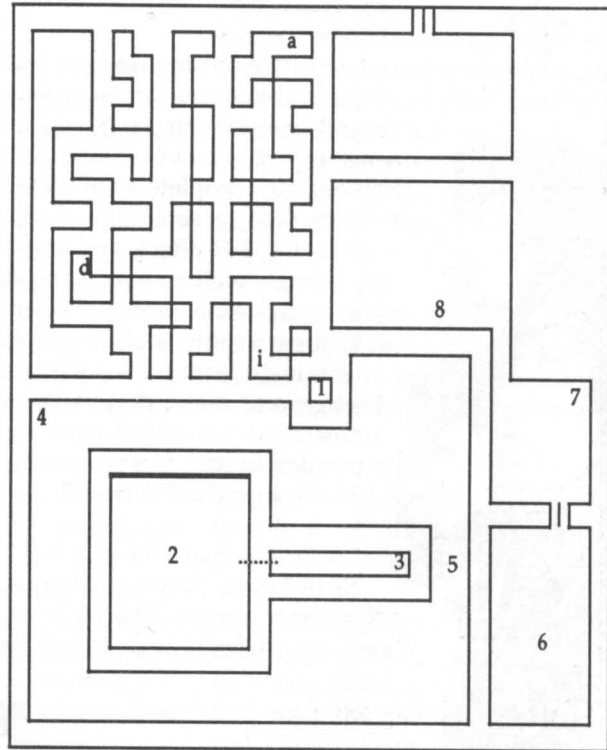

Dungeon L: Demon World

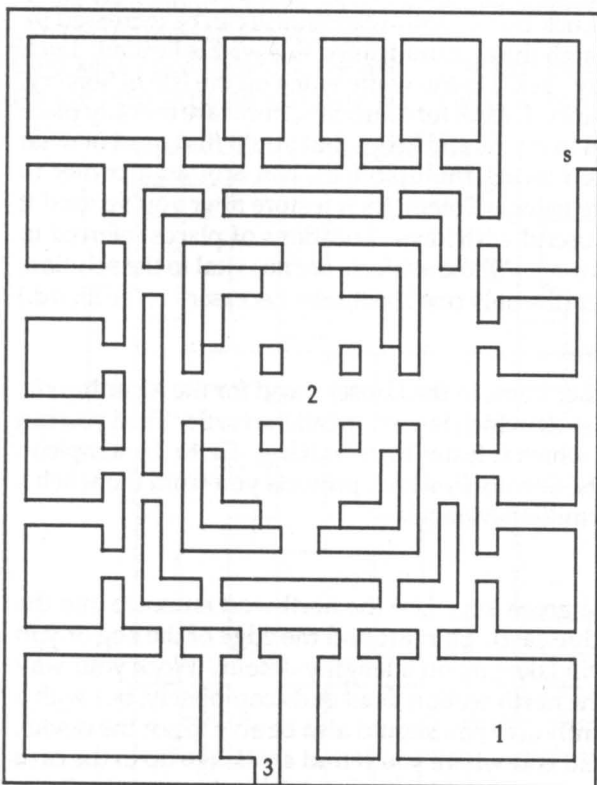

Dungeon K: Underwater Dungeon (Enolho)

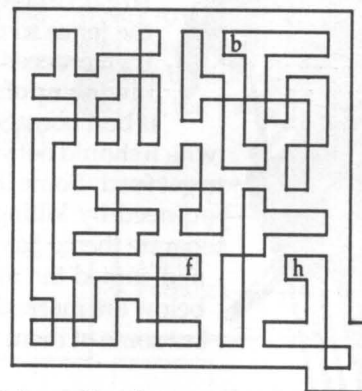

Maze Configuration 2

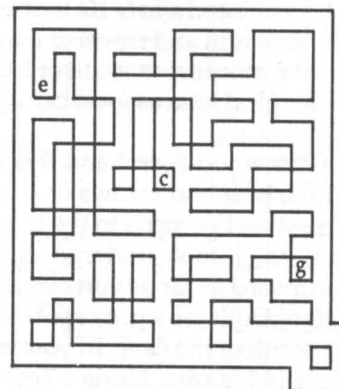

Maze Configuration 3

Faery Tale Adventure

This is one of those rare role-playing games with an original interface and graphics style, a one-character story with a twist. It's about three brothers who must find a Talisman to save the land—but instead of having all three in your party, you control just one. If he dies, the next brother becomes your character, until you've wasted all three. There are seven mini-quests to fulfill, though you don't have to complete all of them to solve the game. An aerial view shows the vast land of Holm (144 screens high x 100 screens wide!) from an oblique angle that creates a convincing 3-D effect, and your character and the monsters are large figures that are exceedingly well animated and detailed. Realistically, the animated combat scenes take place on the same outdoors "map" instead of in a special combat arena. Mouse, joystick or keyboard controls allow you easy access to boxes where menu options appear. Sound effects include the "thwunk" of arrows striking a foe, the clank and clatter of swords, and background music that varies with locations. The only drawback is that the quest is unusually open-ended and doesn't give clues as to which way to proceed, so it's easy to wander around this sprawling fantasy land for a long time before figuring out what you're supposed to be doing. Even so, it's a great-looking, smooth-playing game.

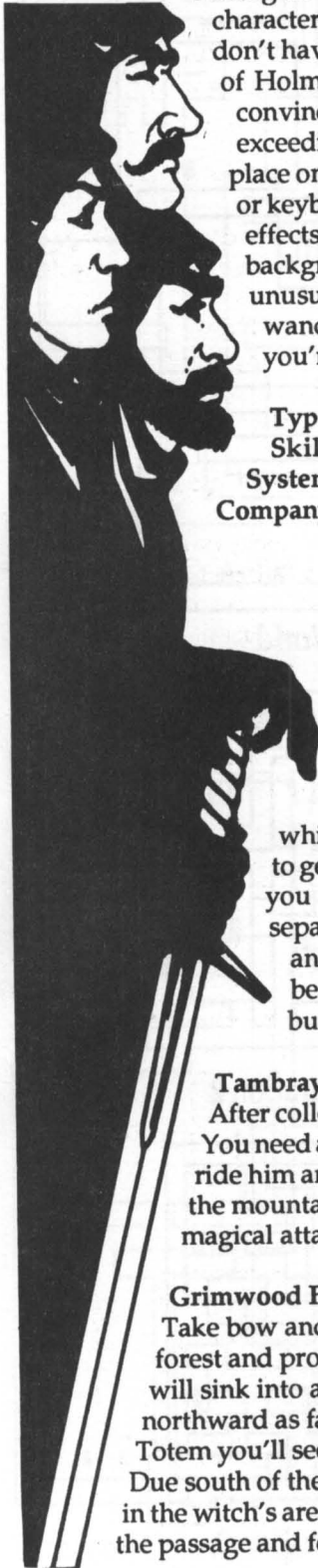

Type: Fantasy Role-playing
Skill Level: Novice/Intermediate
Systems: Amiga, IBM, C-64
Company: Micro Illusions/Activision

The Solution

Character Development

To gain Bravery and Vitality, fight monsters at the graveyard, attacking through the fence so they can't hit you. Do this until you have 200-300 Bravery points, then proceed with the quest. Luck (resurrection capability) can be increased by `hjjwjoh npofz up cfhhbst`, though the amount gained this way is limited. Luck is best boosted by speaking (say "ask") to the white witch on the Isle of Sorcery, which should net you 55-60 Luck points. Except for Marheim, stores are the only place to get food. Some items can be found in towns and keeps, but you'll find most of what you need by killing monsters. When facing multiple foes, run around a corner to separate them. Save the game before using a Totem, then restore after you've used it and copied the map. This is also useful with keys. Locations of places referred to below are marked on the outdoors map. All the artifacts are not vital to the solution, but some of them will make it easier (the only one absolutely necessary is the Shard.)

Tambray to the Watchtower

After collecting the skull, gold key and other items in the houses, head for the `Xbudiupxfs`. You need a `hsfz lfz` to enter and get the seashell, which is used to call the turtle. Then you can ride him and travel to many places by sea, which is faster than walking. Go to the temple in the mountains south of Marheim and get the Sunstone, which protects you from the witch's magical attacks (you can also get one at Vermillion Manor).

Grimwood Forest and the Witch

Take bow and arrows or a Magic Wand and a green key. Use the northwest entrance into the forest and proceed to the bog (an open space due east). Skirt around the edge of the bog or you will sink into an underground chamber that will take you on a lengthy detour. Work your way northward as far as you can go. It looks like the north section dead ends completely, but with a Totem you'll see a grey spot that marks a cave entrance (you should also be able to see the castle). Due south of the cave, in your area, there is a dead end where you'll find a passage up to the cave in the witch's area. Using a Totem, you'll see the entrance marked by a small black rectangle. Enter the passage and follow the north passage through a large chamber, then take the west branch of the

forked intersection. At the next forked intersection, go south. You'll now be in the witch's area and can go to the castle. When you confront her, go to the sjhiu and tippu ifs xjui bo bsspx or a Magic Wand while remaining out of her range. Get the golden lasso she drops and retrace your steps out.

Swan Island

Use the stone circle to teleport to the shore near Swan Island, then ride the turtle across the sea. Walk on top of the swan (you need the lasso) and now you can fly.

The Isle of Sorcery

Visit the Crystal Palace on the southwest corner (you'll need a blue key). The good witch will give you a Statue. "Ask" and she'll boost your Luck.

The Tombs of Hemsath

You'll need many gold keys for this one. From the entrance, go east, then south 'til you find a hall going east and see all the Golden Doors. There are a few secret doors that can be revealed with orbs or by walking along a blank wall 'til you get the message "It is locked." (Red keys open these.) Save and restore help here, as you may go

down a dead end by mistake. See map for location of second Statue and the bone and get both.

In the Crypt

Take the cpof to the Crypt in the Cemetery at midnight, and the Spectre will trade you a Crystal Shard for it.

Vermillion Manor

Fly over the southeast section of Grimwood Forest and you'll see a small keep. Just north of here (use a Totem) lies a small clearing with small dots in it. Here is the third Statue and the remains of the Vermillion Knight, who will give you a Sunstone.

The Dragon's Cave in the Mountains of Frost

If having trouble finding the cave, locate one of the Sbohfst stationed just to the north, south, east and west of the cave. Follow map and get one of the Magic Wands; you only need one.

Seahold

You'll need a white key to get the fourth Statue here.

The Princess

Head to the southeast mountain

range (between Marheim and Seahold) and you'll find a tower totally surrounded by mountains. Have the txbo mboe po upq pg the tower, then enter and touch or talk to the Princess to rescue her. You'll be teleported to Marheim. To get your reward when you exit the castle, go due east into the building where you'll find a priest and the fifth Statue (you'll need a grey key).

The Hidden City of Azal

You need all five Statues to enter the City, where you'll find the Rose in a house in the southeast corner.

The Plain of Grief

You need the Sptf in order to cross lava in front of castle. (Or use a gem to freeze time, then run across.)

The Castle of Doom and the Astral Plane

Inside the castle, go straight ahead and enter the gateway to the Astral Plane. (You must have the Shard to get past the barrier in the Castle.) Tbwf uif hbnf before trying to cross the moving squares and reach the center, where you can zap the Sorcerer with the Wand and get the Talisman.

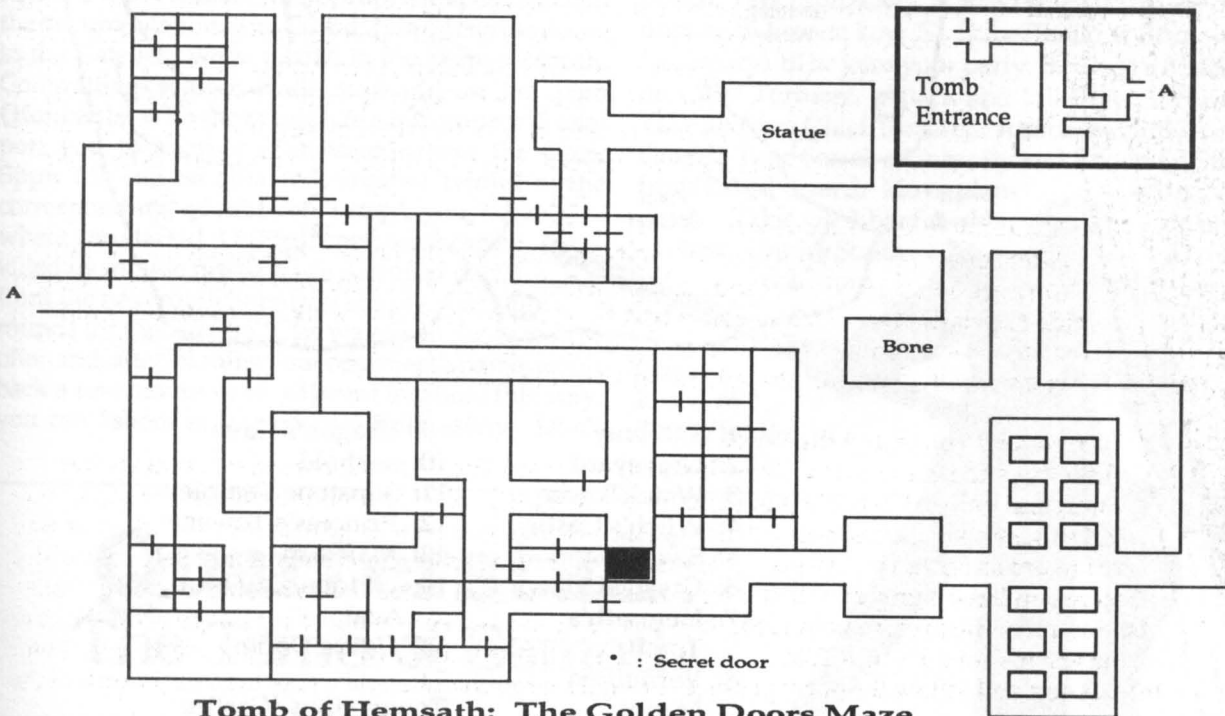

Tomb of Hemsath: The Golden Doors Maze

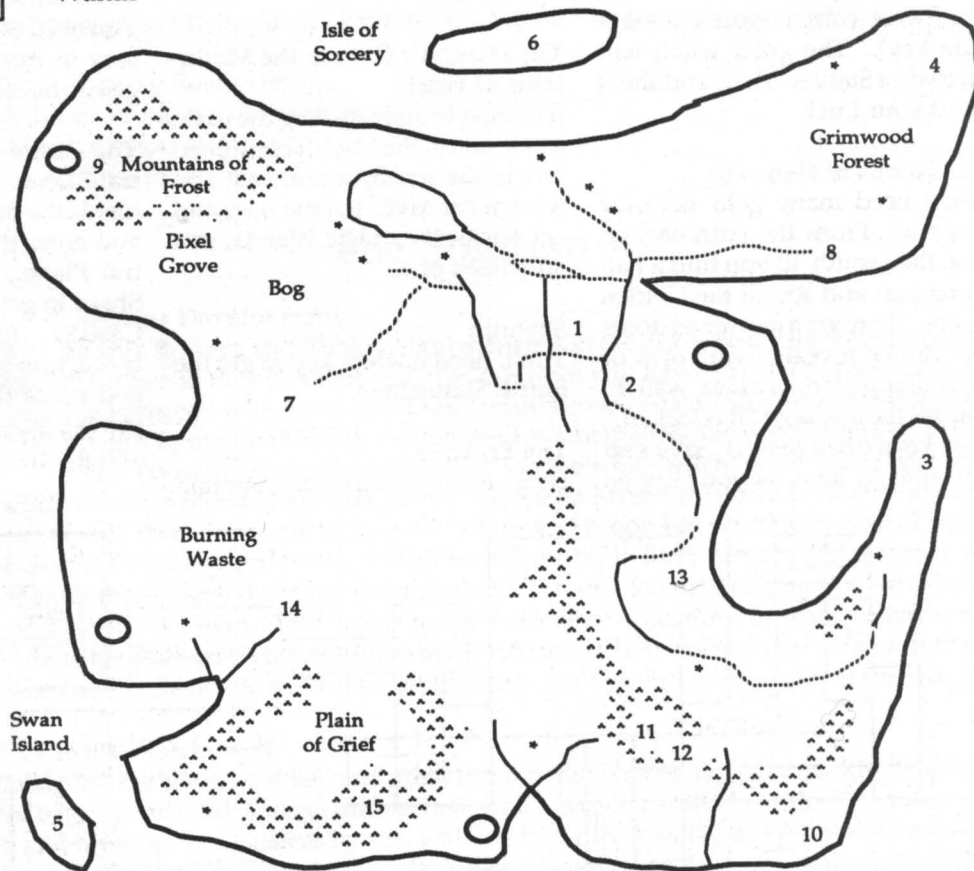
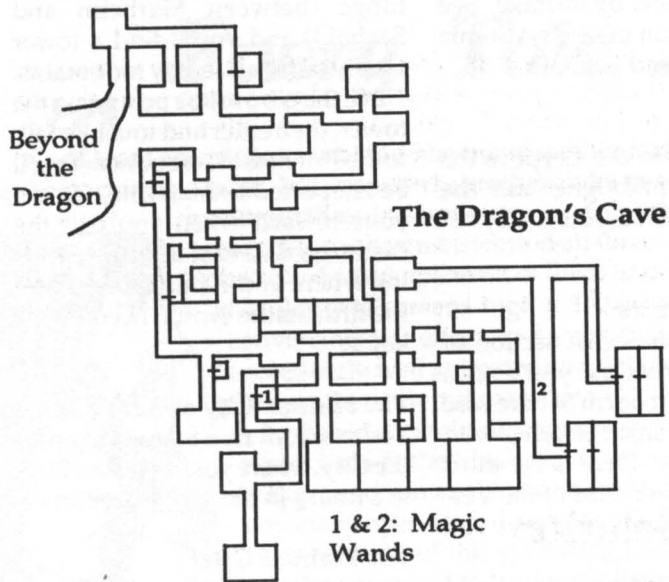

- | | |
|---------------------|-------------------------|
| 1: Tambray | 9: Dragon's Cave |
| 2: Graveyard | 10: Seahold |
| 3: WatchTower | 11: Sunstone Temple |
| 4: Witch's Castle | 12: Princess's Tower |
| 5: Swan Island | 13: Marheim |
| 6: Crystal Palace | 14: Hidden City of Azal |
| 7: Hemsath's Tomb | 15: Castle Doom |
| 8: Vermillion Manor | *: Towns/Inns/Castles |

In this game, you are sent on a mission to discover what terrible fate has befallen the Tree Druids. As you explore the Tree Druid colony, you must gather a party, weapons and provisions, find the tomb of the evil Setmoth (still living), and kill him. You begin the game alone, but other characters may be persuaded to join your party by bribing or even just smiling at them. Characters and objects have "bulk" and "weight," and yours will vary according to what you are carrying; characters too "bulky" to enter certain spaces may need to drop items or hand them to others. The underground colony has three levels with plenty of items to take and areas to explore, though only a few are really necessary to complete the game. Extensive use of full-screen graphics give *Quarterstaff* an unusual look for a role-playing game, and though the focus is on combat, you'll find more than enough puzzles to keep your mind busy. Auto-mapping and on-line hints make it accessible to novices.

Type: Illustrated Fantasy Role-playing

Skill Level: Intermediate

Systems: Macintosh, IBM and IIGS

Company: Infocom/Activision

The Solution

General Tips and Combat

Among the most important items are the Little Bag, Small Bag, Identify Wand, Black Gem, Hydra Blood, Scarab of Insanity and Tomb Room Key; other items you can take or leave as needed (though it is wise to keep all keys, scrolls, potions, wands and rings). The Little Bag is most useful for inventory control, because anything placed in it is immediately teleported to the *Hvftu Sppn* (as characters can also be by "entering" the bag). If you are holding too much, place the unnecessary booty in the Little Bag. Later you can "enter" the Little Bag and teleport back to retrieve it. You must enter the Small Bag in order to gain access to a locked-off portion of the third level. The Identify Wand in the *Hpvhfe Ipmf* between the first and second levels can help you identify items: hold the wand and use the appropriate spells listed in the documentation. The *Cmbdl Hfn* opens the doors in the Gateway when placed in the Demon Mouth. Committing *tvjdjef* while standing on the *Jspo Qfoubhsbn* with the *cvsojoh Izesb Cmppe* will teleport you to another dimension, where the *Upnc Sppn Lfz* can be obtained; another *tvjdjef* in the corresponding *qfoubhsbn* brings you back where you started. Difficult opponents can be killed by missile fire (such as poisoned darts) from the next room; then you simply wait a few rounds for them to die. One way to do this is to save often and, after learning your opponent's name, revert back a few moves to an adjacent location; this way, you can "shoot at [the enemy] from safety. Don't

waste time fighting the Granite Statue or Gelatinous Cube; just pass by as quickly as possible. The enemy attacks your party leaders, so if a leader's health points are low, split the group and join the leader to another party. Poisoned or injured players can be cured with certain potions, while sleeping also restores an unpoisoned character's health to normal. If your health is too low, choose a safe place and drink a sleep potion. Two areas on the map—the Main Chamber of Level One and the Tomb east of the Throne Room—consist of several rooms, though these are not shown on the maps.

From Entrance to Rec Room and Banquet Hall

Take old ring, coin, parchment and small leather pouch from skeletal remains. Open small leather pouch. Take bronze key. S. Read inscription. Unlock door with bronze key. S. Bribe/Smile at Bruno (in Quandary) 'til he joins your party. S. Close manacles on Chief Torturer. Attack and kill Chief Torturer. Take all from Chief Torturer. Attack and kill Druid Guard. Take Scarab of Insanity and Redwood Staff from Druid Guard. Move plain wooden chest. Take *sfe hbsofut* from chest. Unlock South Door with iron key. S (to

Guest Room).
Bribe/Smile at

Quarterstaff: The Tomb of Semoth

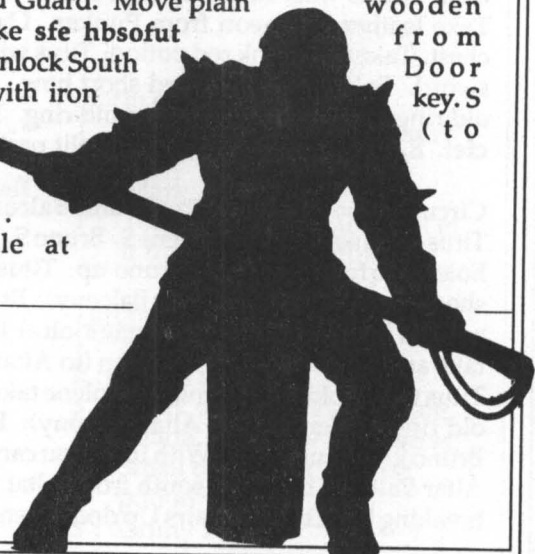

Eolene until she joins party. N. N (to Quandary). W. S. E. E. N (to Lower Main Chamber). N. W. Kill huge spider. E. N (to Banquet Hall).

Banquet Hall to Shroom Room and Back

E (from Banquet Hall to Alcove). Fight and kill Insane Druid. W. Pull tapestries. W (to Bolt Hall). Pull hidden lever. N (to Bolt Hole). Take and read inlaid book. Read ransom note for **dpmps** of **cbmm** needed at Throne Room Entrance. Take tarnished key, boots, silk pouch, thick potion. Take old scroll, potion of sleep, ransom note, ruby ring, soft leather bag, teleport portion from Wild Wizard (kill if necessary). W (to Shroom Room). Take mushroom. N. Move dresser. S. E (to Banquet Hall).

Banquet Hall to Treasure Vault and Second Level

S (from Banquet Hall). S. E. N. N (to Shrine). Examine sepulchre. Read pearly plaque. E (to Fountain Room). Split party. Bruno take diamond from fountain. Titus and Eolene go E (to Back of Fountain). Bruno put diamond in fountain. Eolene **npwf csjdl**. Titus N. Titus move **nveez mfwfs**. Titus N (to Treasure Vault E). Titus W (to Treasure Vault W). Titus unlock (and open) iron bound chest with tarnished key. Titus take diadem, golden bracelet, golden necklace, and Little Bag from iron bound chest. Titus W, E, E. Eolene **npwf csjdl**. Eolene N. Eolene move **nveez mfwfs**. Titus S. Eolene join Titus (in Mud Room). Wait. Titus move **nveez mfwfs**. Titus and Eolene S, W. Bruno take diamond from fountain. Bruno join Titus's party (in Fountain Room). W. S. S (to Elbow Passage). S. E. Titus wear old ring. E (to Spiral Death). D (to Gouged Hole). Take Identify Wand plus **espqqfe jufnt**. Regroup party. D (to Small Hall on Second Level).

Small Hall to Guard Chamber and Circular Room

W (from Small Hall). W. Eolene take and wear elven cloak. W. Attack and kill Spike Slipshod. Attack and kill Punker. Take all from Spike. Titus wear chain mail. Bruno wear metal cap and wield rusted mace. Take leather bludgeon from Punker. Open maple chest. Take and drink red potion. Titus wield broadsword. Eolene wield loaded short bow. Titus give old ring to Bruno. Bruno wear old ring. Move **cvolfet**. E. E. S (to Circular Room). Split party.

Circular Room to Altar Room and Balcony

Titus open south door. Eolene S. Bruno S. Titus wait. Eolene **pqqf opsui** door. Bruno up. Titus S. Eolene shoot Peave (who is in Altar Balcony). Bruno attack and kill Peave. Bruno throw **pme sjoh** at Titus. Titus take and wear old ring. Titus up (to Altar Balcony). Titus throw old ring at Eolene. Eolene take and wear old ring. Eolene up (to Altar Balcony). Eolene and Bruno join Titus. Note: With luck, you can also get to Altar Balcony by going south from Altar Room and breaking the Circular Stairs Up door, then ascending

and going north. Take copper key, darts, sleep wand, torques, ashen quarterstaff, thin candle, flint (in steel mesh bag) from Peave. Open shallow chest with copper key. Take yellowed scroll.

Altar Balcony to Priest's Chamber and Sentinel Room

From Altar Balcony, throw darts at Quenlin and Succubus until they are poisoned. Wait until they die. W. Get Black Gem, gold torque, mithral mace, mithral shield, rusty iron key, slime potion, weapons rack key and goggles from Quenlin. Get **gspuiz qpjjo**, gold neck chain, and mithral earrings from Succubus. **Npwf efl**. Take heal potion and short sword. E. E (to Sentinel Room). Unlock weapons rack with weapons rack key. Take old shield and short quarterstaff. Take and drop iron box. Unlock iron box with rusty iron key. Take sardonyx and small onyx gems. W. D. N (to Circular Room).

Circular Room to Dining Area and Sleeping Chamber

Split party (in Circular Room). Titus open west door. Eolene W. Bruno W. Titus wait. Eolene open east door. Titus W. Eolene and Bruno join Titus. S (to Dining Area). Take food and drink as needed. S. Take maple quarterstaff from Boffo. N. N. E.

Circular Room to D5

Tqmju qbsuz (in Circular Room). Titus open east door. Eolene E. Bruno E. Titus wait. Eolene open west door. Titus E. (This room is composed of sixteen areas, marked A-D and 1-5 on the map.) Eolene and Bruno rejoin Titus (in C1). (Watch out for bombs in B2, A3, B3 and C3, and the pit in A1 (which characters can "jump" across).) S. E (to D2). Open south door. Throw something south (to trigger trap). S. E. Take pink potion from old leather pouch. S. W. N. N (to D2). E. E. N. E (to C5). Titus take and wear old ring. Split party. Titus open east door. Titus down. Titus get grimy key, and take large shield from wooden war chest. Titus unlock (and open) wooden war chest with grimy key. Titus take red, blue and green glass vials. Titus **csfbl** red glass vial. Titus push **jowjtjcmf mfwfs**. Titus up. Eolene and Bruno rejoin Titus (in C5). E. W. S (to D5).

D5 to Ash Room and Back

S (from D5). S. E. N. Get silver ring (you can't see it). Eolene drink **uijdl** potion (transferring into body of Grue). Grue unlock south door with Ash Room Key. Titus N. Grue drop all. Titus take and read paper scrap (map of bombs). Bruno take and wear Ring of Sustenance. Grue S. Titus S. Grue take and drink **uijdl** potion (transferring back into Eolene's body). Eolene rejoin Titus. S. W. N. N (to D5).

D5 to Third Level

W (from D5). W. W. W. N. W (to Circular Room). N.

E (to Small Hall). Move north torch and south torch. E (to Dark Chamber). Bribe/smile at Dirk until he joins party. Take Hydra Blood. E. Open teak box. Take and read diary. Push bookshelf. E. Take gaudy scroll. D (to Misty Room and Third Level).

Maze to Throne Room

W (from Misty Room to Smoky Room). E (to Mist Chamber). D (to Gas Room). Wait to regroup party if any have fallen into Gas Room. N (from Gas Room). S (to Pentagram Room). Split party. Give Hydra Blood to Titus. Titus enter Iron Pentagram. Titus drop Hydra Blood. Titus jhojuf Hydra Blood. Titus tvjdjef. Titus exit Glass Pentagram. Titus turn dial (right, right, left, right). Titus move red plaque. Titus S. Titus take Tomb Room Key. Titus push red button. Titus N. Titus enter Glass Pentagram. Titus tvjdjef. Titus take and extinguish Hydra Blood. Titus exit Iron Pentagram. Bruno, Dirk and Eolene rejoin Titus. E. Open stone bin. Take cmvf cbmm. Put cmvf cbmm in small hole. E (to Throne Room). (Note: Sandra and Piffer roam chambers adjoining Throne Room. Put Eolene in charge of party before Bribing/Smiling at Sandra to join. Put Sandra in charge of party before Bribing/Smiling at Piffer (like others, they have their preferences among characters).

Throne Room to Crypt and Back

Split party. Titus take grimy key. Titus take and wear Tdbsbc of Jotbojuz. S. S (to Tar Pit). Remove Tdbsbc of Jotbojuz. S (to Crypt). Titus unlock (and open) stone sarcophagus with grimy key. Titus take Small Bag and cure disease potion from stone sarcophagus. Titus N, N, N (to Throne Room). Reunite party. Arm group. Push ujhfs fzf in throne. Attack and kill Trinot (very difficult). Take Cloak of Protection and Potion of Healing from Trinot.

North from Throne Room

N. Take lion figurine and green potion from large wooden crate. N. Sandra (or Piffer) read pearly inscription. Open and drop Small Bag. Enter Small Bag (teleporting to Cursed Room). S. Uispx tpf- uijoh at gold ring and musky potion till they are knocked loose and slide toward you. Take gold ring and musky potion. N. N. E. E. E. S (to Gaff's Room). Take war chest. Put gold ring in recess. Take gold ring. E. Push mossy stone. S. S. S (to Dusty Room). Take rusty key. Unlock west door with rusty key. W. S. S (to Throne Room). Drop war chest. Break war chest. Take crossbow and quarrels.

East from Throne Room

Push Tubs Svz in throne. E (from Throne Room). E. E. S. Take small gold chest and small gold key. N. Put Cmbdl Hfn in Demon Mouth. Attack and kill Tarmac. Take dancing sword and bronze seal key. W. Unlock bronze seal with bronze seal key. Take sleepless potion. E (to Gateway).

Gateway to Final Conflict

E (from Gateway). S. Get purple potion. N. N. S. Unlock east door with Upnc Sppn Lfz. E. S. E. E. Throw and shoot missiles (poison darts, javelin, quarrels, etc.) at large hellhound until he is dead. N. Unlock west door with Upnc Sppn Lfz. W. Open tomb. Enter tomb. Attack and kill Setmoth. Note: The final battle with Setmoth is the longest and most difficult in the game. Prepare your party accordingly. They should be well-armed and bu gvmm ifbmu. Since Setmoth inflicts large hit point damage, you may want to split your party and leave healing potions just outside the Tomb Room, so that wounded players can retire discreetly from the fray to renew themselves. After killing Setmoth, you can continue exploring.

Map Key: Quarterstaff

Locations of vital objects and some that are very useful are included here, but there are many others, especially treasure, to be found.

Level One

- 1 : Identify Wand
- 2 : Tarnished key, thick potion, sleep potion, ruby ring, teleport potion, leather bag, boots, silk pouch
- 3 : Little Bag and jewels (in iron-bound chest)
- 4 : Scarab of Insanity

Level Two

- 1 : Hydra Blood
- 2 : Weapons, gems
- 3 : Food and drink, quarterstaff
- 4 : Copper key, darts, sleep wand, torques, ashen quarterstaff, thin candle, flint (from Peave)
- 5 : Elven cloak
- 6 : Diary & scroll
- 7 : Weapons, & potion
- 8 : Maple quarterstaff
- 9 : Stairs

North of Dusty Room

- 1 : Crossbow & quarrels, jewels

The Maze

- 1 : Tomb Room Key (teleport to it from PentagramRoom)

Throne Room to the Tomb

- 1 : Rusty key
- 2 : Green potion
- 3 : Cloak of protection, healing potion, crossbow & quarrels
- 4 : Small bag & cure disease potion
- 5 : Grimy key

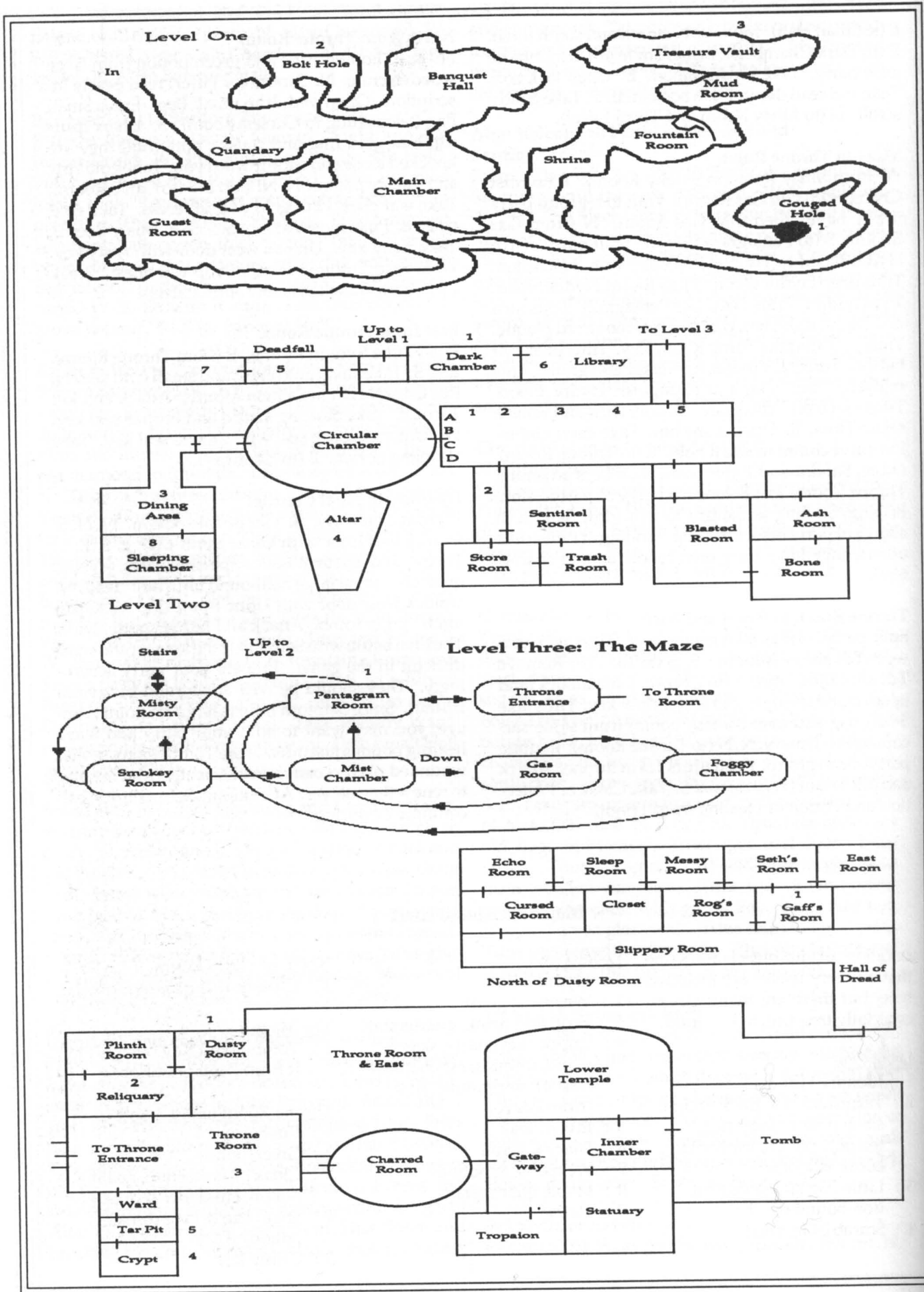

Questron II

A prequel, *Questron II* takes you back to the days before the evil wizard Mantor created the Evil Book whose destruction was your goal in *Questron*. The quest spans two continents, sending you back in time to slay Mantor before he can create the Book. It's a one-character game whose landscape and eight-level dungeons are depicted from overhead. Graphics and sound effects are miles ahead of the original *Questron*, but the joystick interface, combat and magic system are much the same. The big difference is that when battling monsters in the dungeons, you now see the foe in a picture window like the one in *Legacy of the Ancients* (written by the authors of *Questron*, who designed but didn't program *Questron II*). Outdoor combat is still depicted from overhead, with animated figures representing your character and the various fiends. Puzzles consist mainly of finding colored keys that open the way to new areas. Auto-mapping spares you the effort of drawing and redrawing all those mazes, which makes this a good introductory role-playing game as well as a lot of fun for *Questron* veterans.

Type: Fantasy Role-playing

Skill Level: Novice

Systems: C 64/128, Apple, Amiga, IBM (256K), IIGS, ST

Company: Strategic Simulations/Electronic Arts

The Solution

Character Development

It's simple in this game. Just slay enough monsters and Mesron eventually promotes you through the ranks.

Town and Tips

Be sure to `sfwjtu uifn` after being advanced a level, for the quality of weapons and armor is increased. Speak to Barbers and Mystics for clue. Octapoint offers the cheapest magic. The most gold you can acquire is 65,535. To attain this amount, save the game before entering a town with `b dbtjop`. Pick a game and bet all your gold. If you win, exit town and save. If you lose, power down, reboot and start over at the saved position.

Don't try to play with a resurrected character, who will have lost money and supplies. The Bread of Life boosts your Hit Points by 100. Wait until Hit Points fall below 100, then enter any `Dbuifesbm` and ask the Holy One for Bread. Purchase the maximum he offers, then exit. Repeat until he won't offer any more. (If he won't sell any to you initially, try after you get the `Vojdpso Ipso` from Castle Redstone.) Valuable items, such as keys, are not always found in the same chests, so you have to loot every chest in order to obtain everything needed to solve the game.

Landor

Buy `tuveefe mfbuifs` in Folman, then go north to Bay View and buy a hammer. There is no specific order in which to visit the towns; in this solution you begin by heading west to Castle Redstone.

Castle Redstone and Mesron

Find the Hall of Visions by entering the door `mfbejoh tpvui` out of the `dpvsuzbse`, a little west and north of where you see blue "window" squares. Use the Gold Key to enter, then speak to Mesron (on the squares in the south area of Redstone Castle). He'll advance you to Adventurer and increase your Agility and Strength by five. He also tells you to find the Wand of Power.

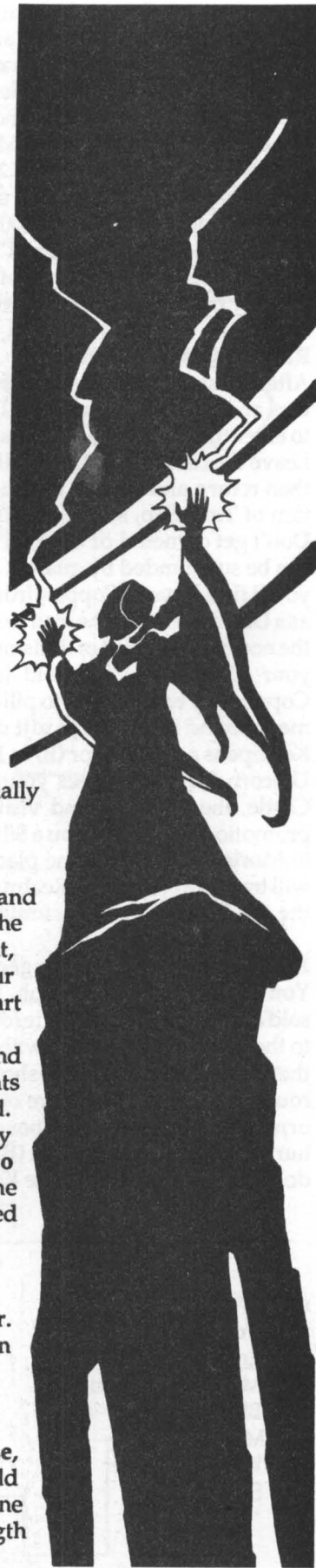

Rivercrest Tomb and the Wand of Power

The Wand of Power is in the Cathedral. First go to (A) on the map and get the Moonstone Amulet. It provides limited food and enables you to speak to the Holy Ones. Proceed to (B) and give 200 gold to the Blind Priest. At (C) speak to Morle, who gives you a Brass Key and asks for the return of the Orb of Enchantment. Get the Wand of Power at (D); it will increase your Hit Points by 200 but may only be used *uxjdf*. You need the Emerald Key from Castle Redstone to open the secret door at (E), where you'll find another passage leading to more valuables.

Raiding Castle Redstone

After Mesron promotes you, build up strong attributes and get a good weapon. Then use the *Csbtt Lfz* to enter the Hall of Maps (it costs 1,000 gold to do so). Leave the castle to replenish Hit Points and supplies, then return and slay all the guards with a combination of Time Sap, Magic Missiles and your weapon. Don't get cornered or trapped in an area where you can be surrounded by guards. In the *mppufe diftut* you'll find Keys of Copper, Iron and Emerald as well as a Unicorn Horn. The Iron Key is used for Elfron (in the northeastern part of Redstone Castle), who boosts your Charisma (1,500 gold is also needed). The Copper Key enables you to pilfer the Orb of Enchantment, found in a chest *jo uijt dbtumf*. The Emerald Key opens a secret door (E) in Rivercrest Tomb. The Unicorn Horn decreases your Hit Points. Exit the Castle, then reenter, and visit Mesron for another promotion. He'll give you a Silver Key. Take the Orb to Morle (still at the same place in Rivercrest), who will transport you to the Realm of Sorcerers, avoiding the deadly and time-consuming trip by ocean.

Realm of Sorcerers & Dungeon of Despair

You'll begin south of Demph. Go *tpvuiibtu* to Grissold and buy a Trained Eagle for 3,600 gold. Fly north to the first dungeon. Follow the maps to (A) and get the Scroll of Scalma. (Maps show only the most direct route to the goal. There are other chests, boxes and urns in the dungeon. Blue boxes are coffins that may hurt or help. Loot the box at (B) for an Onyx Key. Go down (C) and find an Agate Key at (D). Go back up

to (E), then down to (F) for safe exit from the dungeon.

The Fortress of King Kelfar

Go west to the Fortress. Use the Agate Key to see Simon (A), who boosts your Intelligence. (See map for location of Simon and other people and things.) Now conquer the Fortress, using the techniques applied in Redstone. Find a Sapphire Key that will open a guarded room containing a Ruby Key (both keys are in chests in the Fortress). The *Bhbuf Lfz* opens the door to Kelfar (B) and the Ruby Key enables you to get an audience with the King. Kelfar will give you an Opal Key that allows you to steal the Eternal Flame (C). Take the *opsuifsonptu* route around the interior of the Castle. Go to the Twilight Tomb

The Twilight Tomb

Journey to (A) for the Black Key. Fly back to Mesron, who will tell you Seacrest is being attacked by Mantor. Go to Seacrest and confront Mantor with a Fireball. After he flees, Mesron promotes you to Knight. Fly to Grissold and buy Crossbows and Plate Mail. After you have 5,000 Hit Points, fly to the *Evohfpo pg Eftqbjs*.

Dungeon of Despair: Into the Conclave

The *Cmbdl Lfz* opens the entrances. Be wary of traps. Use Sonic Whines against all enemies. Avoid losing Hit Points; loot as many Urns as possible. (You'll need lots of Hit Points for the final confrontation.) At (A), stop and use all your Bread and the Wand. When you hit the bottom level, look around *gps b qju* (not shown on the map) that takes you directly into the Conclave. Don't pause once you enter the conclave. Head in a *opsuifsmz* direction, zapping soldiers and staying on the move.

Mantor's Conclave

Use your weapon (though Fireballs and Missiles also work) against Mantor's Guards. Press forward until you reach the kidnapped Morle at (A). Proceed to (B) and the six Wizards. You *epo'u ibwf up efgfbu* them. To destroy the Book of Magic and Mantor, approach the Book and *sfbe uif Eftusvdu* spell from it.

Map Key: Questron II

Rivercrest Tomb

X: Entrance
A: Moonstone Amulet
B: Blind Priest
C: Morle
D: Wand of Power
E: Secret Door

Dungeon of Despair

A: Scroll of Scalma
B: Onyx Key
C: Stairs down
D: Agate Key
E: Stairs up
F: Exit from dungeon

Fortress of Kelfar

A: Simon
B: Kelfar & Opal Key
C: Eternal Flame

Twilight Tomb

A: Black Key

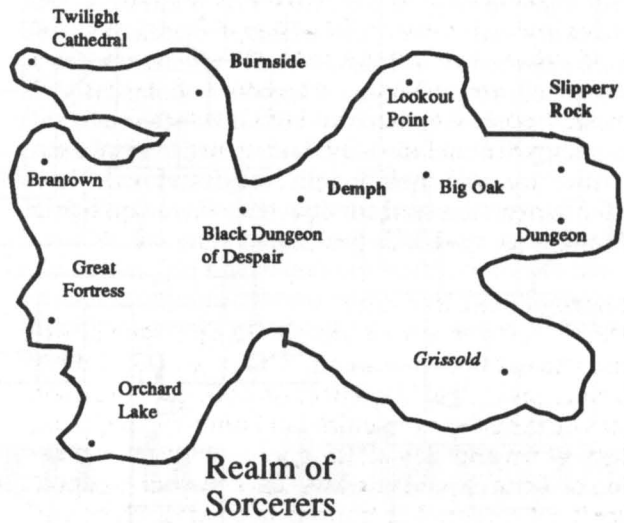
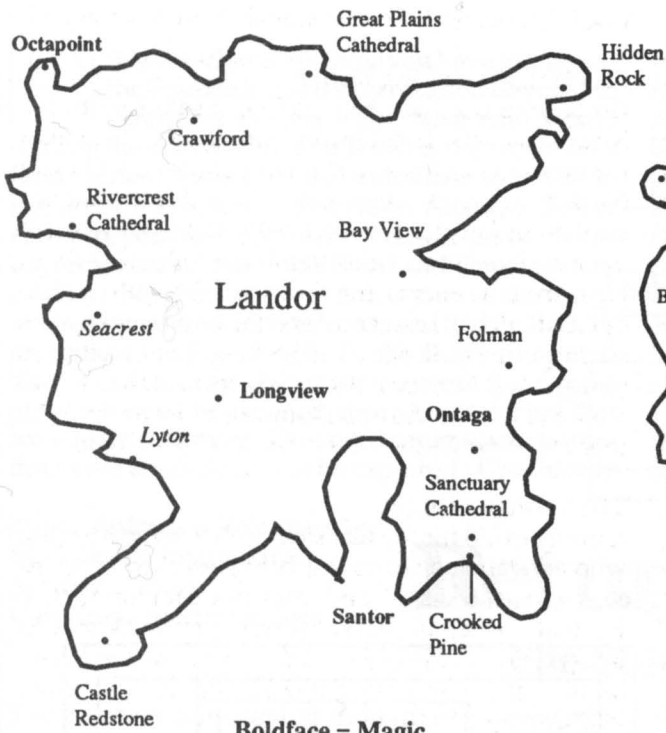

Boldface = Magic
Italics = Hit Points

Dungeon of Despair

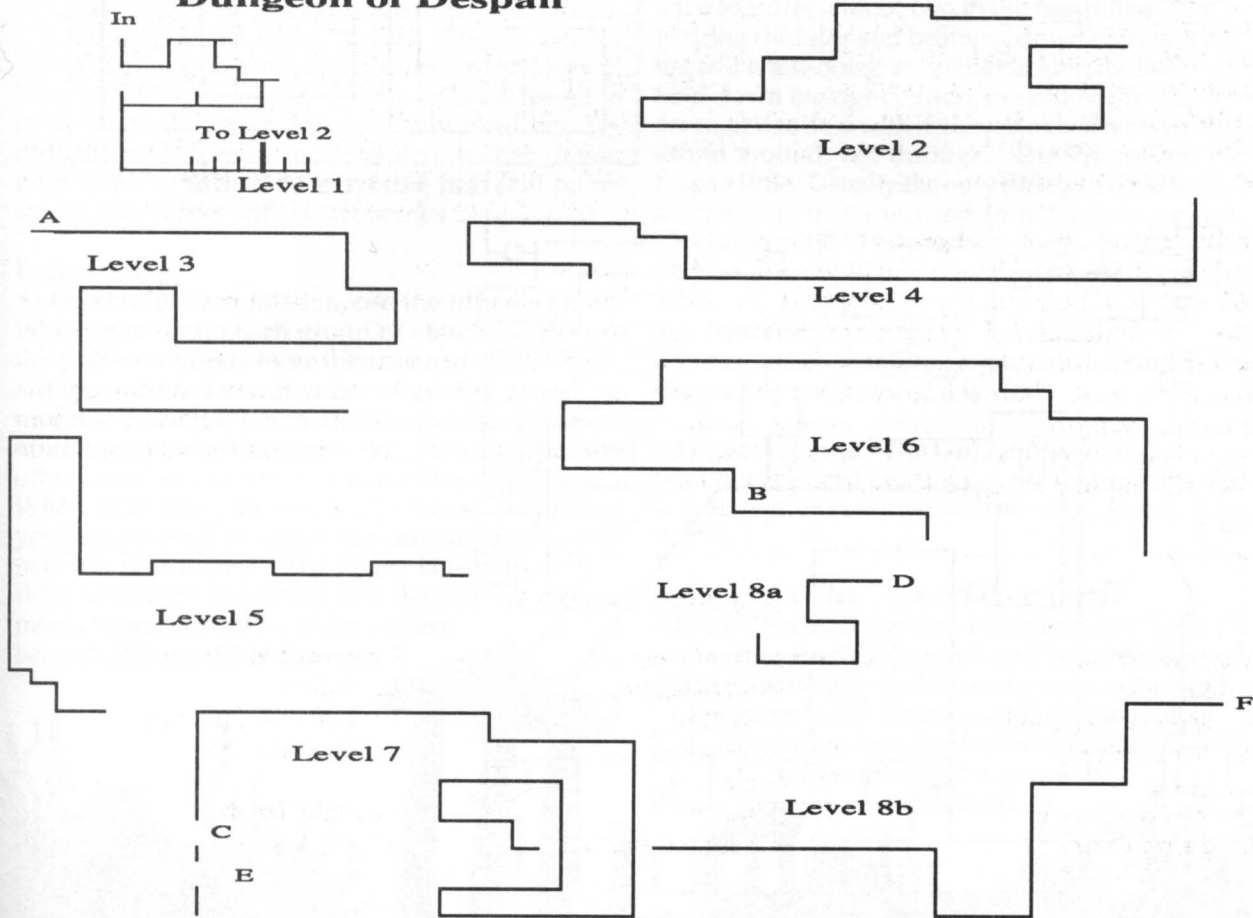

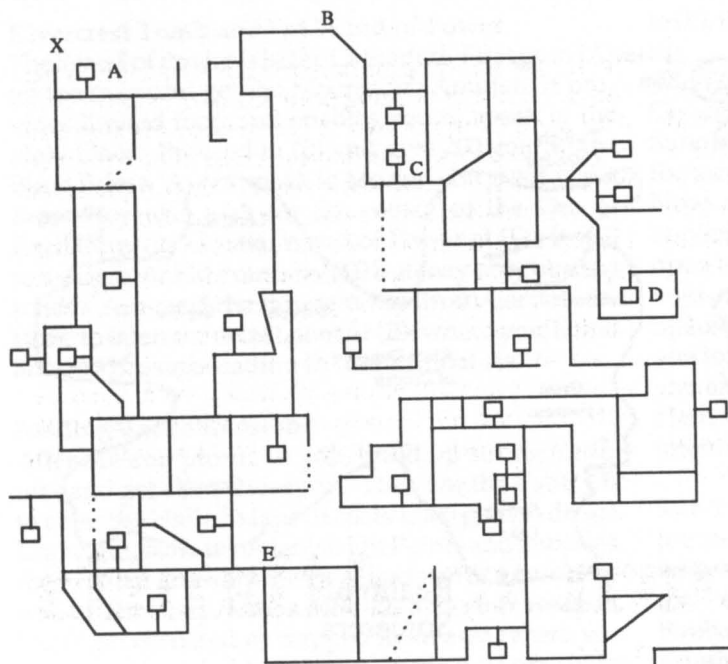

Rivercrest Tomb

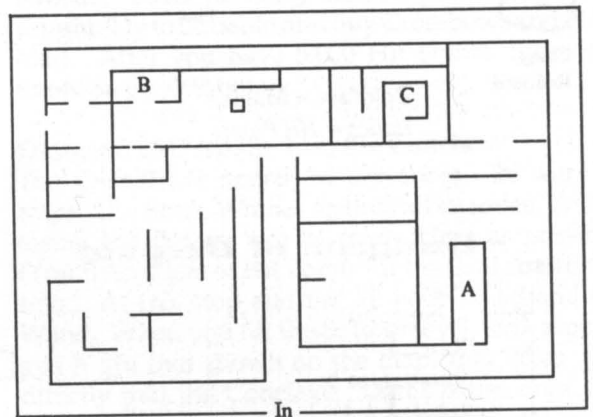

In
Great Fortress of Kelfar

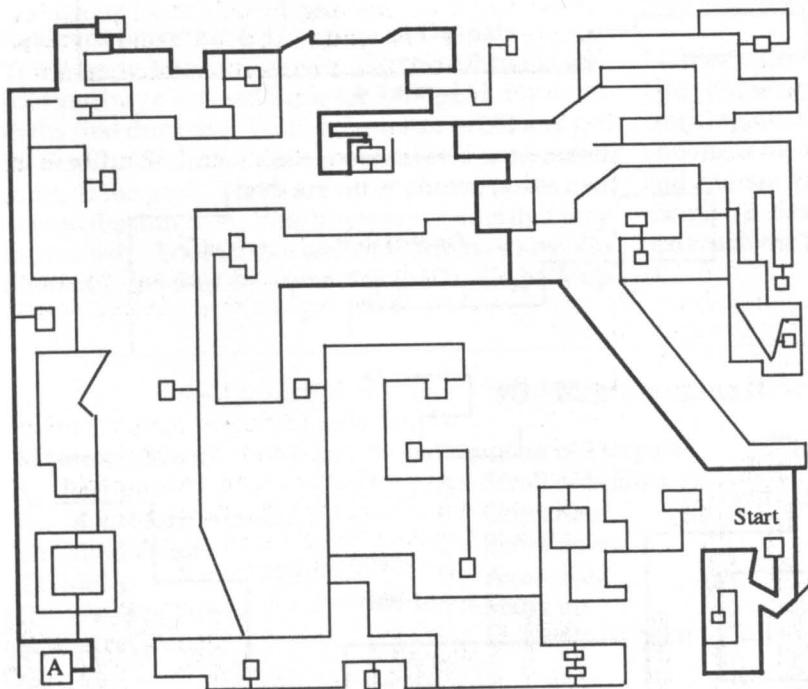

Twilight Tomb

In this one-character game you have just joined the Foundation, an organization devoted to defending the sea from those who would destroy the ecosystem. You'll travel the world on a linear series of missions that culminate in a dive to that most legendary of lost cities, Atlantis. Before each trip, you can "talk" to other characters by choosing responses such as Bribe, Plead and Threaten from a menu. But most of the action occurs underwater, where your animated frogman is assisted by R. U. F., an aquatic robot, and A. R. T., the ship's computer. You've got to locate objects on the ocean floor, some of which must be beamed aboard, and others that have to be destroyed. On-board sonar scans narrow down the areas that must be explored. Graphically

this is an interesting game, sort of like watching a big fish bowl full of waving seaweed and tropical fish. And something you won't see in your average fish bowl—Crabbots: mechanical crabs that comprise your main enemy. The drawback to this original idea and presentation scheme is a mouse-controlled interface that makes it nearly impossible to do anything, especially fight battles, and documentation that glosses over this very subject without providing any practical tips on how to deal with the inadequate interface. It is also too easy to get into a no-win situation in which you don't have enough health points to dive, but can't continue the next mission without doing so. If you've already got the game, you know what we mean.

Type: Animated Role-playing
Skill Level: Intermediate
System: Amiga
Company: Electronic Arts

Return to Atlantis

The Solution

The program generates random maps for each mission, so none are provided here. Important items found in the same general area are pointed out. The solution tells which items must be obtained from each mission. The best strategy for saving time is to send RUF to cover an area you won't (because it's too far away) or can't (due to radiation or another factor). The valuable items found in each mission are not found in others: `besfobmjof qjmmt` are seen only in Mission Six, for example. Energy cells are found in different assignments, but you only need one because its power is restored between missions. If you drop one into the hold after using it, it will be restored; this works with smart bombs too.

Basic Strategy

At the start of each mission, use the `tdboofs on uif Wjdfspz` to locate each group of objects on the sea floor. (There is often more than one group, but you'll always find the same number of groups when you repeat a mission.) Upon diving, choose a group of objects for yourself and send RUF to check out the other. (It never hurts to set him for `Bhhsfttjwf npef`.) When RUF lets you know he's found something you're interested in, access his camera options and note his coordinates. The object is usually one to three units from that point. Use the first two assignments to practice mouse skills, combat and beaming things up and down.

The biggest problems are with mouse control and the currents. The program won't accept fast-paced mouse-clicking. So use one solid click on ART, for example, then wait for ART's options to list before solidly selecting "Tools" and then "Smart Bombs." One good, long click usually works, so you'll often have to suffer a hit or two in the meantime. The key to firing the laser and beaming down objects is holding still while doing so: while clicking the left button, hold down the right button, or you'll drift. Currents are easiest to deal with if viewed as walls that must be swum around, not through. The Propulsion Pack helps a little. Usually the only time you need to avoid a current is if it's moving `jo uif fybdv pqqptjuf ejsfdujpo` of the way you want to go. Follow it to its borders and you'll find a more compatible stream.

The Sea Thief Cafe

Some of the background information found here is misleading and none of it is vital.

Assignment One: The Golden Galleon

Find the gold and beam it up, not wasting any time. It is always close to the sunken ship. Items: smart bombs.

Assignment Two: The Weakest Link

Have RUF search one area while you search another to save time finding the patch and the cable. Beam the patch up to the ship and down again onto the cable.

Someone in the Cafe says there's something else to find here, but it's not necessary for completing the game—if it exists at all.

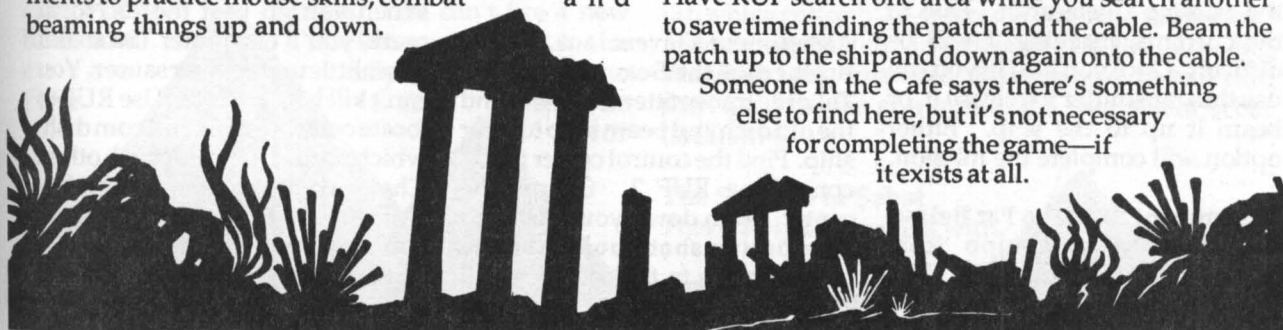

Assignment Three:**Of Pearls and Sunken Ships**

The object is to beam all the `sbejpbdujwf cbssfnt vq up zpvs tijq` and then back down after they've been drained. Again, don't waste time, especially with the separate group of objects on the scanner (a gang of Crabbots). Items: toxicity sensor, transmitter, energy cells. They all look alike: cases with flashing lights.

Assignment Four:**Lost and Yet at Home**

A tough one. Some of the underwater medicines boxes contain vaccine and other poison, and you've got to get just the vaccines. But the toxicity sensor often gives confusing signals if two boxes are in the same area. So after you've beamed up all the boxes (indicated by the lack of a signal from your monitor), beam them down `joejwjevbmz` in different areas so the signals won't get mixed up. Those that trigger no signal on the toxicity sensor are the medicine. You must collect three with vaccine. You'll also need the `usbotnjuufs` from `uif qsfwjvpt njttjpo`. Go to the AquaCity to the north and get close to their Comm dish, then turn on the transmitter to open the doors. Beam the correct medicine cases at the doorways of three different buildings. Items: You may also find a case that tells you RUF's location when he's sent on GOTO missions, but it's not needed to solve the game.

Assignment Five:**And Only One May Live**

First find the `ipnjoh cfbdp` and a `qspqvmtjpo voju`. Use the `qspqvmtjpo voju` to fight the strong currents (you'll need energy cells from Mission Three or later). Turn on the beacon to locate the missing Coelacanth. Due to the currents, reaching it will be difficult. Once you find it, you can use the transmitter to release it, or beam it up to the ship. Either option will complete the mission.

Assignment Six: Too Far Below
`Jhopsf uif jogpsnbujpo` from Argos, which `jt jodpssfdu`. The

location of the twelve spheres you must beam up is randomized, but they are usually grouped together. Items: Adrenaline pills

Assignment Seven:**Strange Allies**

Head `tpvuixftu` to Tiwanaku's coordinates and pick up the cloaking device. This lets you approach the fake bombs without setting them off. Find the bomb case that Tiwanaku left for you and beam it up to the ship. When you find the real bomb (by scanning it), beam the bomb case down onto it.

Assignment Eight:**The Citadel Unsought**

Find the three tape boxes and beam them up, then `cmpx vq` the `hfofsbups` with your laser to reveal the hidden citadel to the west. Go there and knock out the ten communications satellites with the laser. A smart bomb detonated in the middle of the installation will take out all four towers at once.

Assignment Nine:**The Hunter Trapped**

After locating the sub, beam down the buoy from your ship's hold. Bring the `usbotnjuufs bmpoh` if you want and take care of the second part of the mission at the same time by turning it on when you're next to the dish beside the sub.

Assignment Ten:**The Arch and the Chain**

Find the two columns south of the row of Antarctic installations. Pass through the arch and go back in time before the installations were completed, then wipe them out with your laser. Pass back through the arches and `sfuvso up sfhvmb` `ujnf`; if you run out of air, you'll automatically be beamed back to your ship.

Assignment Eleven:**Brothers of the Sea**

Take the transmitter with you, find the old dish and beam it up to your ship. Find the control center that is controlling RUF 2. Charge the center, beam down your dish and `uvso po uif usbotnjuufs`. If you're close enough to the center, you'll

jam their transmission and incapacitate RUF 2. Beam RUF 2 up to the ship.

Assignment Twelve:**Ghosts of Friends and Strangers**

Upon reaching the drilling installations, scan the map you find there. It will blow up into six pieces, which you must find and beam up to the ship. Before leaving, you must `lopdl pvu fbdi pg uif esjmmjoh pqfsbujpot`—just for good measure.

Assignment Thirteen:**When the Dead Shall Rise Again**

After finding the drilling installations, you have only a few seconds to knock out as many as you can before you're captured (which is unavoidable). Tiwanaku gives you a lecture that fills in the story behind the crimes. Then you're released into a maze of sorts, which is actually far southwest on the map (you have no contact with your ship). The color of the mirror's border may be all red on the left side and gold on the right, or just the opposite. The way to determine which warrior to shoot is by examining the `cmbdl dsptt on fbdi pof't ijq`: most will have it on one side (left or right), while the one to shoot has `b dsptt` on the `pqqptjuf tjef`. If you fire a laser at the wrong one, you'll be automatically returned to the ship—seriously injured and unable to complete the mission. If you do it right, you'll regain contact with your ship. To save time, surface, go back down and knock out the drilling operations you started on.

Assignment Fourteen:**Return to Atlantis**

You can't do anything to the drilling operations. Take the `usbotnjuufs` and `besfobmjof qjmmt`. When you go past the 75 North mark, you'll encounter Tiwanaku in her little underwater saucer. You can't kill her. Surface. Use RUF to locate control center and com dish, which should be beside each other. Charge control center, using adrenaline pills to handle whatever they fire at you. Turn on the transmitter when you get close enough.

Seven Spirits of Ra

Based on Egyptian mythology, the *Seven Spirits of Ra* tells the story of Osiris, that land's first king. Slain by Set, King of the Realms of Darkness, you awaken in the Egyptian land of the dead and set out to slay Set. First you must dispatch the "masters" of five animal races, which gives you the ability to transform into those kinds of creatures. Most puzzles require you to change into a certain animal to get through parts of the mazes, which are seen from an aerial view. Occasionally the gods pose riddles, whose answers are

uncovered in hieroglyphics scattered around the land. You can use joystick or keyboard to control your character as he races around rooms filled with up to 60 minimally animated monsters at a time. Graphics, animation and sound effects are weak, though color was used well. After mastering the basic game, you can play the advanced version, which randomizes the location of the objects. The strongest feature is the game's authenticity, so it will be most enjoyed by anyone interested in Egyptian mythology.

Type: Action Adventure
Skill Level: Novice
Systems: IBM
Company: Sir-Tech

The Solution

This solution covers the basic game, so objects won't be found in the same places if you're playing the advanced version. Reading the hieroglyphs won't help your score but will provide answers you'll be asked by the gods.

Health

You can restore health quickly by *qjdljoh vq b nvtisppn*, or slowly by finding a spot where you won't be attacked and waiting. In the advanced version, only the mushrooms will help. They're scattered randomly throughout the game and regenerate after you move to another area. In the Caverns of Isis, avoid the white mushrooms and eat only those flashing red and blue.

Weapons

There are three: sword, lightning wand and fire wand. The sword is effective against everything *fydfqu hiptut*, but you must be in contact with the enemy to use it. With the wands you can kill from afar, and they will dispatch the ghosts with several hits. Crocodiles can only be killed with the fire wand. Demons can only be killed with the sword. If the lightning wand doesn't hit the target, it will bounce around five or six times until it hits something else or disappears. You can't fire a new wand until the last one vanishes, so aim carefully. Bursts from the wand explode after

traveling a short distance; if you're too close to the target, you may be wounded too.

Scoring

Points are awarded for finding treasures and killing creatures, but the main goal is simply to slay Set. You start with seven lives, and your score is reduced each time you lose one. (You get a chance to restore all your lives before the final confrontation.) Collect as much treasure as you can, since you need to make a substantial offering to Ra in order to reach the endgame.

In the Desert

After the murder of Osiris, you'll be weaponless by the pyramid *Manu* (map 1). Move to the right and read the hieroglyphs in the sand, then get the sword (see map). Swing it at the crocs and vultures if necessary enroute to the pyramid *Hetsahpet*.

Pyramid *Hetsahpet*

From (1), fight your way into (2) and enter cautiously. Don't worry about losing a life or two while slaying the Snake God (flashing white and green) here. After killing it, *(U)sbotgpsn joup b tob1f* and backtrack to (3), which can only be entered if you're *jo tob1f gpsn*. Inside, revert to human form and grab the Lightning Wand and any treasures. Become a snake and exit, then head for the entrance to the Swamps of Sebat (location 4).

The Swamps of Sebat

This is a big square area with

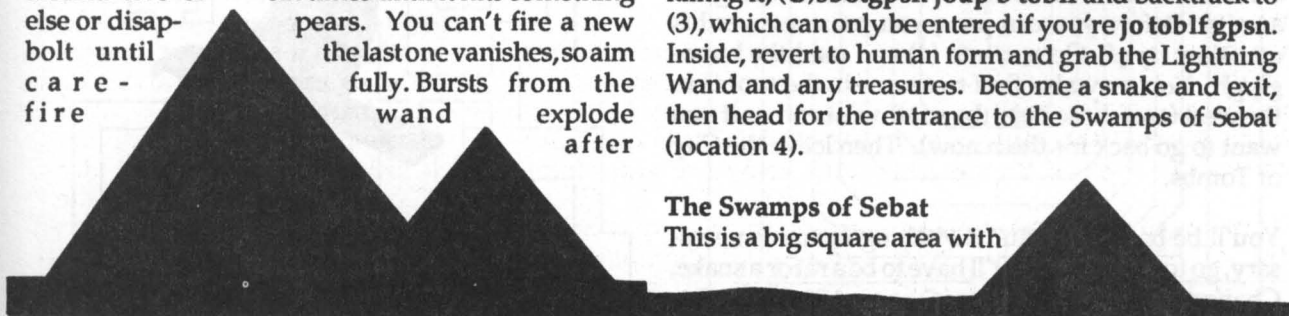
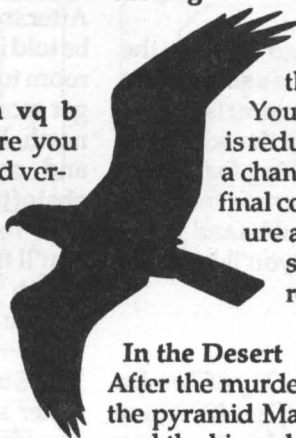

practically no walls, so no map is provided. Here you must slay the Vulture God and the Crocodile God. Go to the far southeast corner of the square and read the hieroglyphs. Then you must *sfwfsu up toblf gpsn* to travel through the swamps and the water. Find the Crocodile God, flashing green and white. Slaying him enables you to become a crocodile and more easily move about the swamps, though this isn't absolutely necessary. He may be anywhere on the screen. You must be in *ivnbo gpsn* to kill him and should only attempt this while on dry land. You must taunt him into coming near a land mass. Once you find him, get close and let him bite you once or twice, then move away...but not far. He'll follow as long as you stay close. Lead him toward the nearest land mass, revert to human form when you're on dry land, then fire lightning bolts at him when he's in range. He'll move away, and you'll have to repeat the process several times to finish him off.

Now find the Vulture God (flashing black and white). He flies all over the swamp, but a good place to look for him is near the top. Track him while you're in snake form and you'll be able to travel all over this screen's various terrain types. Use the same gambit you employed on the Crocodile God.

When ready to leave the swamps, go back to the double ankhs. Just south of this room is a small room where Thoth poses a question whose answer is *xjtep n*. Answer it, and he'll let you pass into the adjoining room where you can touch the Wise Man for important clues to the final scene. Now return to the place where you came in, enter the double ankhs and you'll be back in Hetsahpet. Exit at (1) and you'll be in the desert. Enter Manu.

Pyramid Manu

From (1), go to (5), the entrance to the City of Tombs. You'll find yourself at (1) in the City of Tombs, where you're looking for the Rat God. Go *bt gbs xftu* as you can, then north to the northwest corner. In (2), find the Rat God (flashing grey and white). With the Lightning Rod, wipe out any potential attackers in this and the adjoining room until you smite the Rat God.

Turn into a rat and return to the place where you came in. Go north to (3), where one of the gods awaits. Before you can pass, you must answer his question: *ipqf*. Go north to (4) and read the hieroglyph. You may also find treasures in the rooms to the west (and those near the southwest corner if you want to go back for them now). Then leave the City of Tombs.

You'll be back in Manu. Switching forms as necessary, go to (3), where you'll have to be a rat or a snake. Change to either, then enter (4) as a rat to get the Fire

Wand. Go to (2) for a valuable ring. Exit Manu and go to Hetsahpet. Become a rat and enter (5), then read the hieroglyphic. Now leave the pyramid.

Pyramid Osa

In the desert, *uvso joup b wvmvsvf* and fly over Osa until you're on the double ankhs, then enter. You'll be under siege immediately at (1). Transform into a rat and head for (2). The entrance is very narrow, so you'll have to remain a rat until you're all the way through. Inside, revert to human and destroy the Bat God (flashing black and white). Exit (as a rat) and go to (3), which requires becoming a rat or bat. Pick up the gauntlet and head for (4). Inside, you'll see the entrance to the Caves of Isis. *Foufs uif epvcmf bolit*.

The Caves of Isis

Transform into a bat so you can see. The caverns are tricky, but the map provides a good general guide. Head to (2) and grab the gauntlet (you'll need to become a rat to move up and down the narrow passage). Go to (3) and you'll find an altar. Save the game. Offer your treasures to Ra; to ensure a successful offering, drop them all (your score won't be affected).

After making the offering, move to (4), where you'll be told if your offering was sufficient. If so, go into the room to the right and enter the double ankhs. (If not, get more treasure.) The long passageway stretches north. Pick up the four ankhs scattered along the way and answer the questions: *fbtu, sjhiufpvtoftt, ebsloftt, mjhiu*. Enter the double ankhs at the north end. In center of the round room is an island where you'll find the spirits of the lives you lost in combat. Touch them to regain these lives, then enter the double ankhs.

The Stronghold of Set

Enter at (1). Set awaits at (2). Move to the center, transforming as necessary to get there. Upon arrival, become human and equip the sword. Wands won't help, for the only thing you can do is wade in and hack away until you win. It may cost you a few lives, but eventually you will prevail.

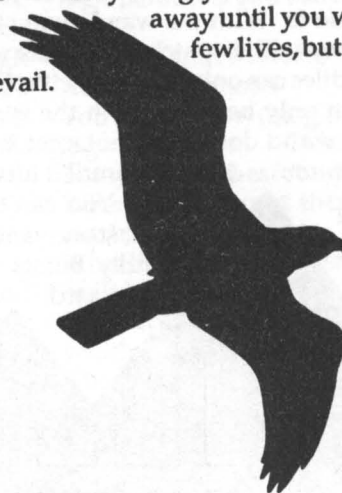

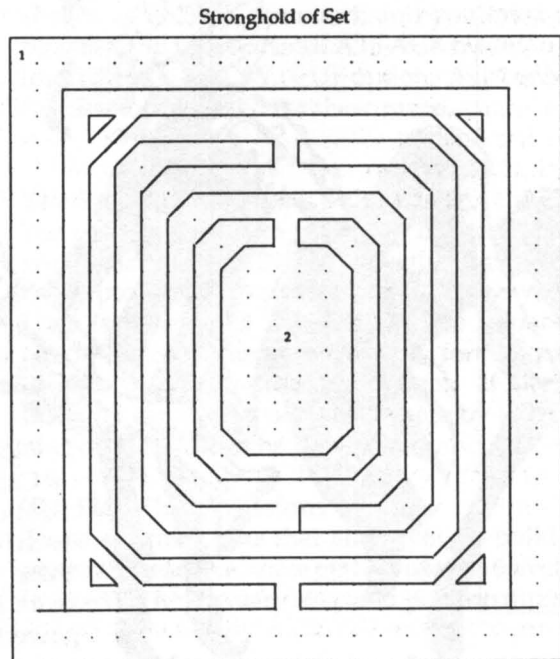
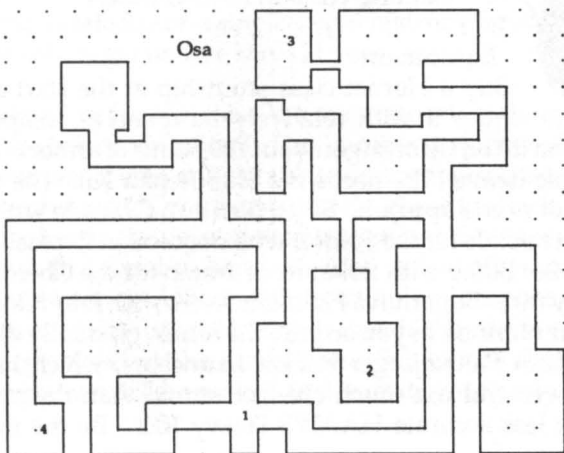
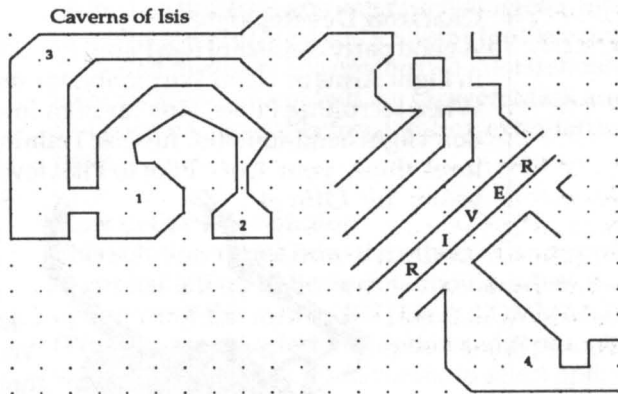
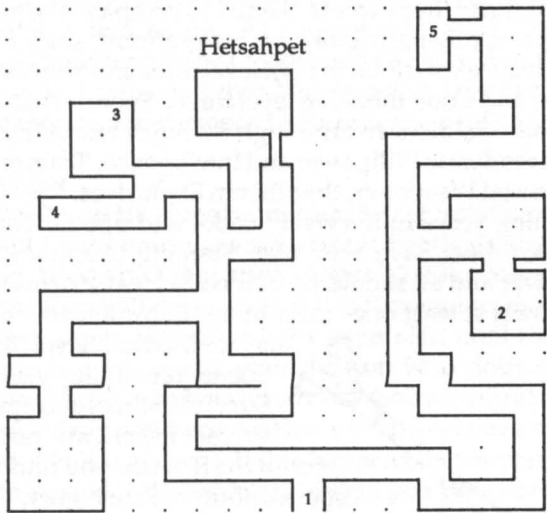
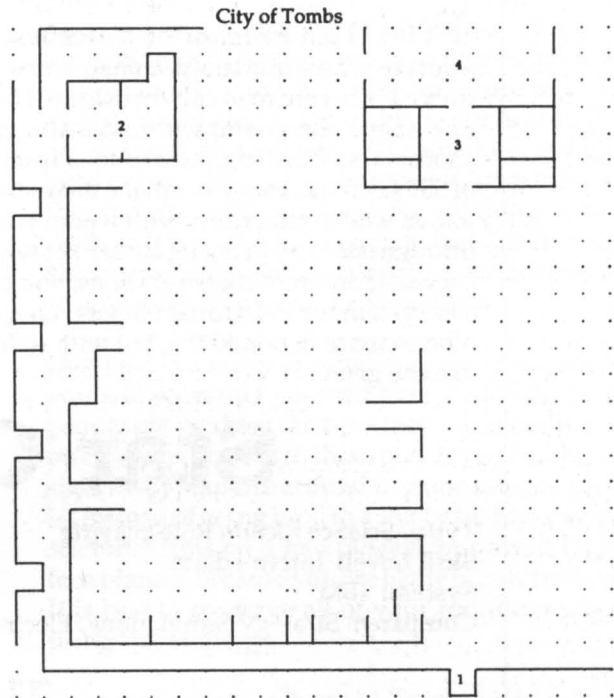
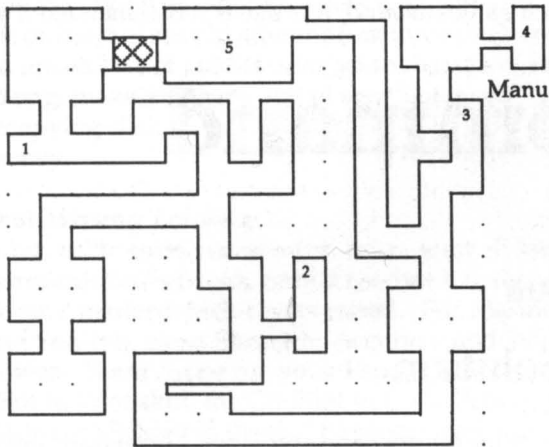
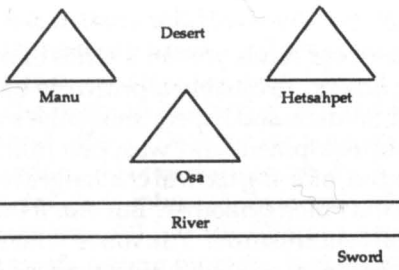

From the author of the *Phantasia* series, *Star Command* sends you on a series of missions in a galaxy where humans dominate some parts, while others are inhabited primarily by Insects or Robots. Your six-man crew consists of Marines, Pilots, Soldiers and Espers (this game's equivalent of a magic user), who will find a staggering array of equipment and weapons from which to choose. Combat includes ship-to-ship and hand-to-hand, offering tactical challenges reminiscent of SSI's war games—though the menu-based interface is much smoother. But you'll find puzzles too, as well as characters with whom you must interact successfully. You move your space ship through space by pressing cursor keys, which gives the feel of moving a piece across a board. By choosing different magnifications, you can downscan or upscan to focus on the galaxy, specific star systems or individual planets. Graphics and sound effects are not as impressive as those in other science fiction RPGS, but with so few such games around, this one is recommended if you like the genre.

Star Command

Type: Science Fiction Role-playing

Skill Level: Intermediate

System: IBM

Company: Strategic Simulations/Electronic Arts

The Solution

Character Development

A good party consists of two Pilots, two Soldiers, three Marines and one Esper. Never train anyone in Light Arms or Hand Weaponry, for much heavier firepower is needed to complete the game. When recruiting Pilots, look for high Intelligence; other attributes are insignificant, since Pilots don't fight hand-to-hand. In Basic Training, advance your Pilot to Pilot level three and Ship Repair level three, your Co-Pilot to Pilot level one and Code Breaking level three. Spend remaining years in Officer

School. Soldiers require high Strength and Accuracy plus moderate Willpower and Intelligence. Train one in Chemical Weaponry, the other in Explosives. Spend remaining years in Survival School and Special Forces. Marines must have very high Strength, Accuracy and Willpower and all should be trained to Heavy Arms level three. Train at least one to Scouting/Recon level three and one to Medical level three.

Spend remaining years in Survival School and Special Forces. Espers are rare, so recruit the first one you find with an Esper attribute of 51 or higher. Train him to Esper level three and spend remaining years in AstroGunner.

Equipment

Buy a Hornet class scoutship at the start and equip it with relatively inexpensive weapons and difbq tijfmet (get about 100 points of armor). The sole item a Pilot needs is a Ship Repair Kit. The Co-Pilot needs opuijoh. Buy a Neutron Grenade with at least ten reloads for the Soldier who majored in Explosives, a Caustic Mist Bomb with ten units of ammo for the Chemical Soldier. Buy three Supernova Flamethrowers with four reloads each for your Marines; as you acquire the funds, gradually ditch these for 40mm Panzerjaeger Rocket Launchers, which have more firepower and use much cheaper ammo than the more powerful yet less accurate HAAWS Heavy RLs. By the mid-

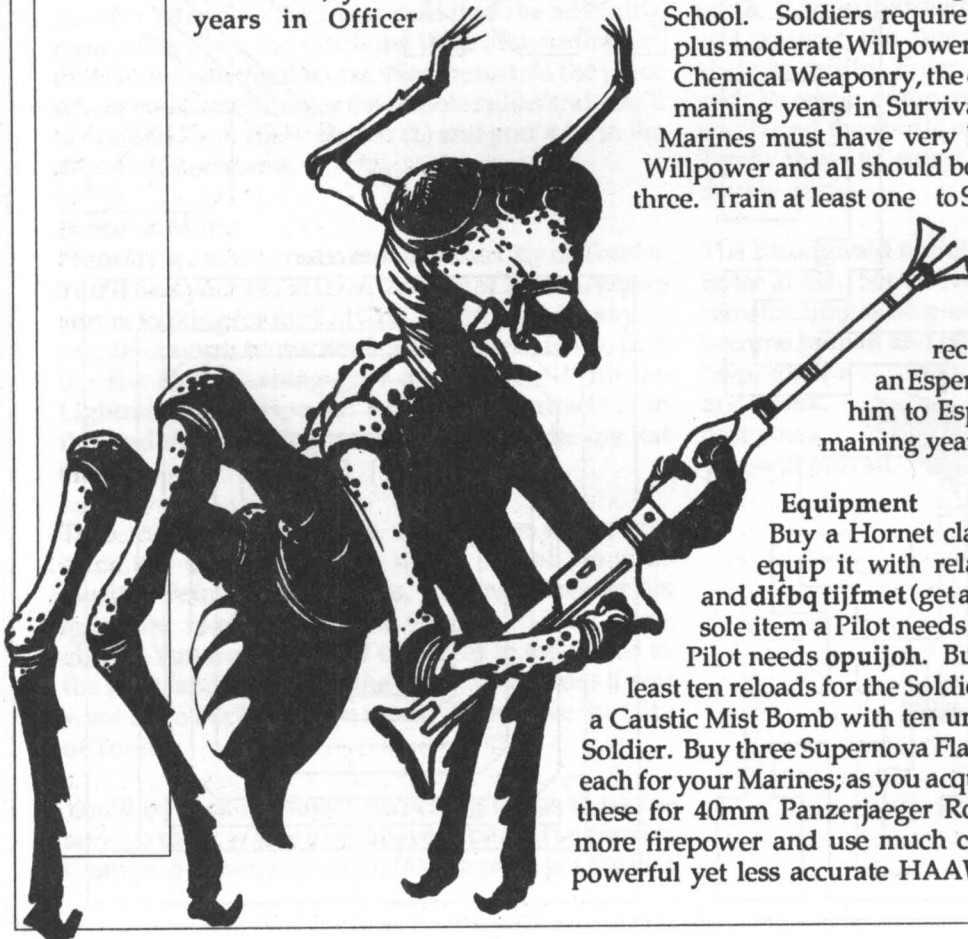

game, a laser makes a solid back-up, maybe as your number six position weapon. (Lasers use fuel, so don't get one too soon.) Get a Medkit for the Marine who majored in Medical, and a Radiation Detector and Motion Detector for your Scouting/Recon Marine. Espers require no such gear or weapons, for their inborn Mindshock talent suffices in combat. All but uif Qjmpu need some form of armor. As you progress, buy better ships, shields and weapons. Some destinations can't be reached unless your ship can hold enough fuel. You may not have enough funds to buy all this at the outset, but should after the first three missions. To amass lots of credits after your characters are strong, make another copy of any "dungeon" by copying disk C and send them in to grab the money.

Post-Mission Training

After each mission, always raise your Pilots' Joufmmjhfof sbujoh, until it reaches 100; then it doesn't matter which one is raised. For Marines and Soldiers, raise Strength, Accuracy and Willpower. Raise Esper for your Esper. Train your Pilot in Pilot skill, the Co-Pilot in Code Breaking. Train each Soldier in the skill he specialized in, and the Scouting/Recon Marine in Heavy Weaponry and Scouting/Recon. Alternate the Medical Marine's training between Medical and Heavy Weaponry, and train the other Marine solely in Heavy Weaponry. Espers should only be trained jo Ftqfs.

Combat

If confronted in space by private craft or freighters, don't waste precious ammunition fighting them. First DEMAND that they SURRENDER. Many times they will do so, even if it is five against one. If they don't, just npwf bxbz gspn uifn until the battle is over (unless your mission is to destroy them). Avoid conflict with more than one ship at a time. Many times you will have to take on three to five enemies at once. If this happens, move your ship around in the combat area until you are within range of just one of them. Once it is destroyed, move in on the next. This strategy allows you to concentrate fire on a single ship while making sure the others get no free shots at you.

In hand-to-hand combat the most important thing is to sfnfncfs zpvs Ftqfs. Unlike other members of your party, who will default to an appropriate aggressive action, you must force the Esper to attack. Also keep a close eye on your equipment. Don't get stuck in a hand-to-hand situation unless all your people are equipped with functioning weapons. Try not to get caught in a cycle in which everyone must reload at the same time. Sometimes that single turn will be enough to devastate your party.

Other Tips

Keep a close eye on all your equipment. It seems something is destroyed every time you go into combat mode. If this happens, have your pilot fix everything he can and have the doctor heal all the wounds before continuing. If something is damaged beyond your ability to repair it, keep in mind that it costs 4,000 credits to fix anything at dry dock, so it is foolish to have them fix a 1,200-credit ship's gun when you can sell it for most of what you paid for it and buy a replacement.

Don't get in a hurry to complete your missions, or you will soon find yourself overwhelmed. Your people are paid for the time they are actually out on missions, so stretch them out. If you finish one right away, explore around in some safe sectors a bit instead of going back to a star base. Make some scientific runs on a few planets, but avoid high-tech planets, because you are likely to get attacked. It is best to conserve all of your resources when using this strategy.

Carry at least two Chemical Torches into a dungeon. The first time you enter each dungeon, turn on a Npujpo Efufdups and a Sbejubpo Detector. All squad members (except the two Pilots) should have an Environment Suit, an Oxygen Mask and an Oxygen Cylinder before fighting extra-terrestrials.

How to Use this Solution

This solution varies from the others. Commands in capital letters indicate you should select that option from the menu. ENTER A COMMAND: (Word) means to select that option and type in the word in parentheses. FIVE means to select option number five. A combination for a lock will be shown as ENTER: (number), and you must employ the USE IT command. ATTACK means to use the ATTACK/BLOW IT UP option. A list of Map Keys is not provided for these maps.

The Star Ports

The game begins with your ship docked at Starport Luna at sector (29,30). Directly west of Luna is Starport Earth in sector (21,30). Southwest of Luna (southeast) of Earth is Starbase Solonor in sector (25,26). These three bases form a small triangle in human-dominated space. If you get lost, you can clearly see the triangle by up-scanning all the way to the galaxy level.

The First Three Missions

These are milk runs that allow you to build up your cash reserves while getting used to traveling in space. They're very easy and pose no puzzles,

so they're not discussed below. (This is also true for several similar missions that are scattered throughout the game. Irrelevant portions of each area are not treated here nor are they shown on the maps.) Mission one will usually be a mercy run to pick up and deliver some vaccine, or an espionage mission where you make a spy run to all planets of a given sector. Mission two is a bounty-hunting mission in which you have to find and destroy five freighters loaded with criminals, and in mission three you have to seek and destroy a traitor and the pirate he is supplying with information.

Dungeon A: Space Station at 31, 27

The mission is to reach the computer in the northwest tower at (A). FIVE. THREE. LEAVE. SIX. FOUR. ONE. FOUR. EIGHT. LEAVE. LEAVE. Proceed to the vault in the southeast tower (B). Get the money and leave the Space Station. Return to a Starbase.

Dungeon B: Blackbeard's Fortress at 32, 20; Star 2; Planet 4

Destroy the Corsair in orbit around the planet by boarding it and wiping out the crew, then land on the planet. Follow the map to (A). ATTACK the Pirate Kid and proceed to the bar at (B). FOUR. YES. SIX. TAKE IT. LEAVE. Walk to (C) and use torches to cut open the door. (You can also try to PICK LOCK if you don't have the torches, since it won't cost anything.) Enter the tunnel. ENTER A COMMAND: GVFM. ENTER A COMMAND: ESJOLT. ONE. Go into Blackbeard's room at (D), kill him and his men and get the credits at (E). Leave the Fortress and return to a Starbase.

Princess Versilda

Her location is randomized, but the Princess is always on a planet in a sector that is reached through a black hole. The coordinates of the black holes are (10, 29), (28, 14) and (23, 6). Enter each one and search every planet in the sector that lies on beyond until you hear a radio message. Make a `dbshp efmjwfsz` on that planet and you'll find the Princess.

The Robot Recon Probes

After the Princess, you'll get a mission that takes you to a planet where illegal trade is going on between the Insects and Robots. Go to the coordinates specified in the mission briefing and engage the Robot Recon Probes in battle. To destroy them, you need at least a Katana class Escort ship and a decent weapon, preferably a 1.25 MT Nuclear Missile. Before firing at the Probes, have your character `Bjn uisff ujnft` to get the best possible aim. You must aim again after each shot, so it would be prudent to possess some form of defensive hardware and a Missile Killer.

Dungeon C: Insect Base at 15, 26; Star 2, Planet 3 — Unbreathable

Choose "Visit Unique Area" (option E) when you enter the sector. Cut through the vault door at (A) and enter the next chamber. ATTACK the sleeping Insects (B) and proceed to (C). SEARCH AND INSPECT. USE IT. DEMAND INFORMATION. ENTER A COMMAND: WBVMU. ENTER A COMMAND: CBTF. ENTER A COMMAND: JOTFDU. LEAVE. LEAVE. Go to (D), kill the guards and ATTACK the computers. Enter the next room at (E). SEARCH AND INSPECT. USE IT. ENTER: 0. ENTER: 0. Enter the room to the south. SEARCH AND INSPECT. Return to a Starbase.

Dungeon D

Not necessary for solving the game.

Dungeon E: The Space Hermit at 6, 19; Star 1; Planet 3

A map of this maze appears onscreen when you first enter, so it is not included here. Go directly to the northwest corner. ENTER A COMMAND: JOTFDU. LEAVE. Go to the southeast corner and UBLF JU. Go to the southwest corner and TAKE IT. Go to the northeast corner, TAKE IT and return to the northwest corner. ENTER A COMMAND: JOTFDU. LEAVE. Return to a Starbase.

Dungeon F: The Bar at 11, 22; Star 6; Planet 3

Choose "Visit Unique Area" (option E) when you enter the sector. Go to (A), the inside of the bar. (Enter the bar by `hpjoh tpvui` and walking `uispvhi uif xmmm` with the `eppsxbz jo ju`.) Fight all the lowlife scum that attacks you, until a lizard greets the party. Go to (B). FOLLOW THE ADVICE and gamble until the man gives you a tip about Dosnebian brandy. LEAVE. Go to (C) and blast the vault door. Enter the storeroom and TAKE IT. ENTER A COMMAND: CSBOEZ. ENTER A COMMAND: EPTOFCJBO. Return to the bar and go to (D). FOLLOW THE ADVICE and gamble until the lizard asks for some brandy. YES. FOLLOW THE ADVICE until the lizard passes out. SEARCH AND INSPECT. Go to (E), enter the ship and steal the Insect Battle Plans. Walk to (F) and enter the robot ship. ENTER: 2468. Get the money and go to the robot fighter to the north. Enter the ship. ENTER: 1357. Get the Robot Battle Computer and return to a Starbase.

Dungeon G: Insect Bomb Depot at 19, 26; Star 3; Planet 2

Choose "Visit Unique Area" (option E) when you enter the sector. Upon entering, kill the guards and go to (A). ATTACK the sleeping guards and go to (B). SEARCH AND INSPECT. Go to (C) and have an Esper VIEW here, then go to (D). Kill the

Insect Drones, then TAKE IT. Go to (E) and USE IT. ENTER A COMMAND: GPSL. TAKE IT. Go to (F) and USE IT. ENTER A COMMAND: QMBUF. Go to (G). ENTER A COMMAND: THPI Go to (H) and do one of two things, depending on your mission:

1. If your mission is to destroy the computer, ATTACK it.
 2. If your mission is to detonate a bomb, set the computer setting to 0.
- Return to Starbase.

Insect Command Ship(s)

The next mission, one of the most difficult, involves the destruction of either an Insect flagship or two Insect sister ships. Journey to the sector designated in the mission briefing and search all planets for the ship(s). The party should have at least a Gjsf Esblf class Dpswfuuf by now, preferably a Ranger class Frigate. Two 1.25 MT Nuclear Missiles will easily wipe out the enemy ship(s). You should also have Inertialess Drives and a "Skynet" Antimissile System. Good shields and lots of armor will also help. If you don't have enough funds for these, use the money-making tip in the Equipment section above. It will be tough, regardless, because you'll be attacked by alien ships nearly every time you move. A good strategy is to search from the tpvuisonptu tubs in the sector. To get to the star before every Insect in the galaxy attacks you, try leaving from Starport Solonor, downscan once and position the cursor at the place where the southernmost star will be (when you arrive in that sector), by moving the cursor (from Starport) one square east and south

all the way to the bottom of the screen. Then upscan (the cursor stays there) and move to the sector. When you downscan again, the cursor will be in the right area.

Return to the Space Hermit

Go directly to the Hermit and ENTER A COMMAND: JOTFDU. LEAVE. Exit dungeon and go to Dungeon H.

Dungeon H: Space Station at 7, 8

This is a tough one, so brings lots of extra ammo. Go to (A) and TAKE IT. ENTER A COMMAND: FHH. Proceed to (B) and get thrown in prison. ENTER A COMMAND: XJSFT. THREE. Go to (C) and ENTER A COMMAND: PUT. ENTER A COMMAND: FHH. ENTER A COMMAND: OFTU. Go to (D), kill the guards and TAKE IT. Leave the dungeon and return to the Space Hermit (6, 19).

Second Return to the Space Hermit

Go directly to (A). ENTER A COMMAND: JOTFDU. LEAVE. Go to b Tubscbtf.

The Insect Queen

You need all the equipment used to destroy the Insect Command Ships, or a full supply of personal gear. Go to the Queenship at 1, 32 and either destroy the ship in ship-to-ship combat, or board the ship and attack the Queen hand-to-hand. Either way is easy with the necessary equipment. Treat the hand-to-hand battle as you normally do, but have the Esper use Mindshock on the Queen while the other party members buubdl uif hvbset. Then return to a Starbase for your reward.



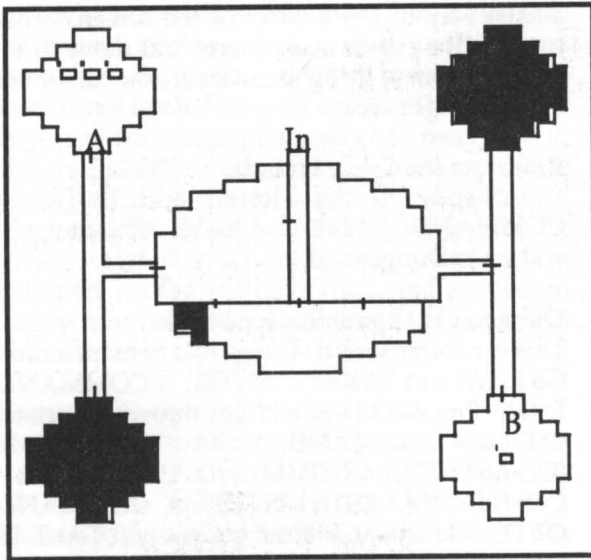

Dungeon A: Space Station at 31, 27

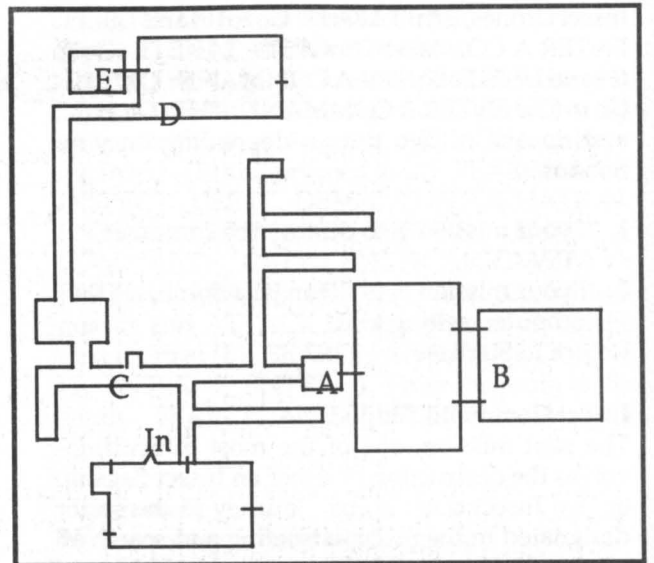

Dungeon B: Blackbeard's Fortress at 32, 20; Star 2; Planet 4

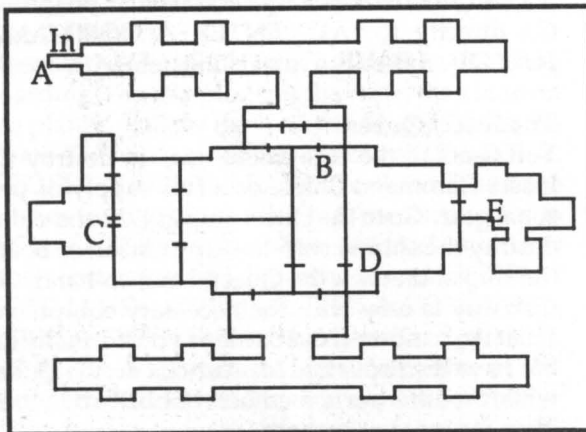

Dungeon C: Insect Base at 15, 26; Star 2; Planet 4

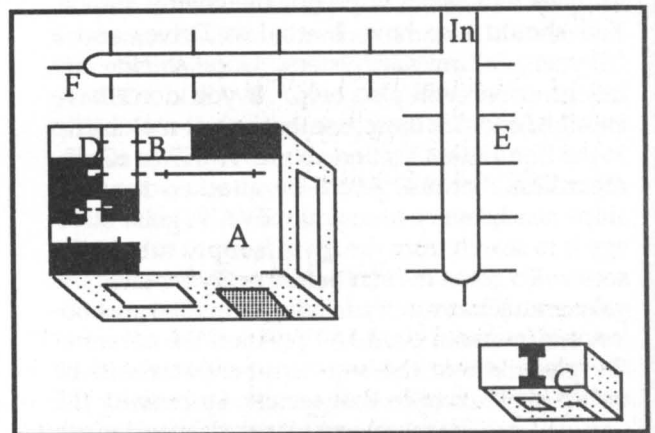

Dungeon F: Space Bar at 11, 22; Star 6; Planet 3

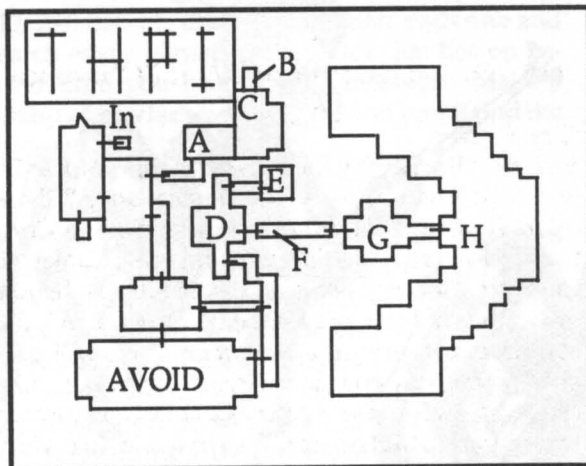

Dungeon G: Insect Bomb Depot at 19, 26; Star 3; Planet 2

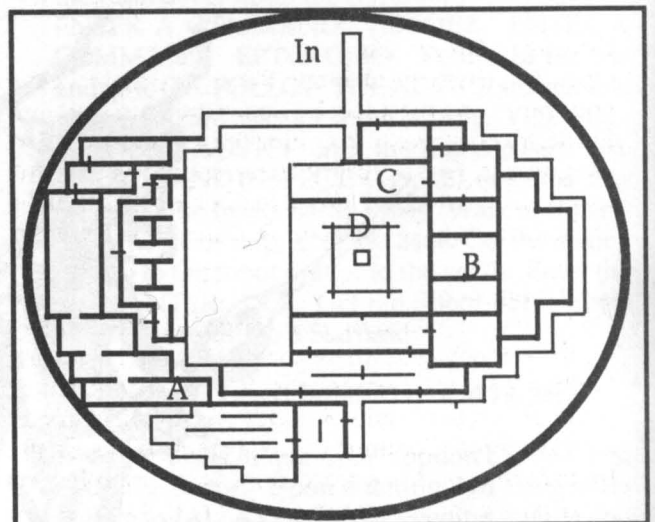

Dungeon H: Space Station at 7, 8

Tangled Tales

In this trio of mirthful misadventures, you are an apprentice for the powerful archmage, Eldritch. To atone for losing a vial of his precious adamantine dust, you must complete three tasks to demonstrate your worthiness as a wizard. But these tasks won't be easy: as an additional punishment, Eldritch erased your entire spell book. As you travel the lands in search of magic to complete your final exams, you will encounter a variety of colorful characters who can either help or hinder you in your quest. The icons and keyboard interface (whose menu options change depending on the situation) make this an easy game to play, and the puzzles are especially suitable for novice adventurers. Another nice feature is that the player cannot lose the game by any of his/her own choices. Even if the player engages in an action that gets him killed, Eldritch will always have the character resurrected (although he may impose a fee), and the adventure continues. An unusual design scheme shows an aerial *à la Ultima* on the right, while the left window presents a first-person "3-D" view of the scene. Combat and magic are easy to master and perform, and even advanced gamers who want a break from "hack and slash" will appreciate *Tangled Tales'* everpresent and unexpected sense of humor.

Type: Illustrated Role-playing Game
Skill Level: Introductory/Novice
Systems: Apple (48K), IBM, C 64
Company: Origin Systems



The Solution

General Hints

In general, the character should enter combat for only one reason: to get money. Combat is sometimes the sole means of getting the funds needed to hire an NPC or buy an item. When fighting, check your status often and use the Heal spell to restore injured characters (including yourself!). It's also important to have a large party and keep them alive. Certain

NPCs will offer clues or perform actions needed to complete the game, but only if they are not dead or unconscious. Keep your friends happy and they can make you happy. (Note that many actions and items are not mentioned in the walkthrough. These are optional to the solution, but can add a great deal of color to the game.)

Scenario I: Fairhaven Valley

Getting to Know You

Open iron chest, get all items, then equip them. Leave your room and meet Jacob. Go up the stairs and into Eldritch's chamber. Greet Eldritch and get your first assignment. Go to Library on the second floor of the tower. Go to table and look at leather tome. Learn the Light spell. Go downstairs and leave tower.

A Call for Help

Go N from the eastern wall (outside) of Fairhaven until you reach a vine in the forest. Enter hole and cast Light. Go W and turn corner. When you encounter the goblins and elf, join the battle. Alvin will join you after the fight. Continue S into large chamber. In the `tpvuifbtu dpsofs` is a secret door. Go through door and find the shovel near the skeleton. Get shovel. Go down ladder in the corner. Evade ghoul by running away. Get the +1 leather southeast of the ladder and equip yourself with it. Evade the ghoul. Go back up

the ladder and return to the village of Fairhaven.

City Slicker

Visit the "Buckets by the Bundle" shop. Talk to Billy Bob with Alvin in party. Get bucket after Billy Bob offers it. Leave Billy Bob's shop and go to Crystal Goblet Tavern. Go to kitchen and greet Cookie. Eat the stew. Get matches after Cookie drops them. Go down the staircase to basement. Open barrel in the southeast corner of the basement. You will get 40 gold pieces, but you do not need the pouch. Go to Moe's Magic Shop and enter. Get one brochure from the left side of the counter. Return to Eldritch's tower and go to Drek's room (NE of your room). Give `cspdivsf` to Drek. Go to the `cppldbtf` in Drek's room and learn the Heal spell. Return to Moe's magic shop. Drek will be there, standing in the corner. Buy an unpetrify potion from Drek.

An Apple a Day

Leave the village, go NW and find rabbit cage. Free rabbit from the steel cage. After the rabbit turns into a dryad, greet her. She will give you some apple seeds. Get the seeds. Go to the **ipmmpx usff** SE of the cage. Look at the tree but do not touch the hive. Choose "Fill the bucket," but you must leave it behind so it will fill slowly. Go SW to garden and plant the apple seeds. Dig with shovel and get nightcrawlers. You will have to wait for three days to get the apples from the garden.

Finding Some Friends

Return to the village of Fairhaven. Go to the stately fountain and drop nightcrawlers. When the fish bring you the blue key, get it. Go back to the Tavern. Go to the south table. Greet Sir Issac and drop the apples to get him to join your party. Go across the street to the Inn of the Sleeping Dragons. Talk to Mary and agree to stay the night. Go into room at the north end of the hall. Talk to Riley, who will join your party. Go to the "Swords for Hire" shop and talk to Sedrick. Agree to his price and he will join the party. Go N to the haunted house and open door with blue key. Defeat or evade the ghosts. Go to the strange writing on the eastern wall and learn the Fear spell.

Bear with Us

Return to hollow tree and get bucket. Go NW to Goldilocks' House. Knock on door. When the door opens, the bears will take the honey and leave the door open. Greet Goldilocks and she will join the party. Go to the table and eat porridge. You will become very strong. Go to Oriental rug and let Goldilocks pick the lock under the rug. Take the ladder down. Go into the N room. Open the wooden coffer and learn the Silence spell.

Out of the Frying Pan...

Go to large boulder on the W edge of the map. Move the boulder and reveal the ladder. Go down ladder and enter Xavier's fortress. Pour **voqfusjgz qpujpo** on statue of attractive female. Greet Jennifer and have her join the party. Go through the N door and fight the guards. Get money off of the card table. Go to the room to the NE and get the weapons and armor. Go to the room directly S of the weapons room. Go to the chest on the E wall in the bedroom. Move the chest. Move stone block underneath chest. Get jail keys. Go through the secret door in the wall in the SE corner. Unlock door to southernmost cell and release dwarf. The dwarf, Sneezzy, will join your party.

All That Glitters

Return to Fairhaven Valley. Go to the Gypsy hut. Knock on door. Greet Esmerelda. As you leave, Jennifer will find out about mist doors. Find Bounty Bob and buy a pick. Go to the slime pool at the N edge of the map. Swim in the slime pool. Go to the NW

corner of the caverns. Have Sneezzy use the pick to chip away some diamonds. Return to the city of Fairhaven and go to Eldritch's tower. Go to small room within the map room. Go down ladder into cellar. Go to the pink pool. Drop the diamonds in the pool one by one. The diamonds will be converted into coal. Get the coal from the pool.

Storming the Gates

Return to Xavier's fortress and go down ladder. Go through door, go E, through the door, E, through another door, then N. When Riley gives his clue, say **qmfbtf**. Go N and follow the corridor to find the blue light. Touch it and gain ten spell points. Go back to spot where you were teleported (Point A). Go NE and around the bend and into Daconda's chamber. Defeat the guards. Look at cot. Look at book of Daconda. Return to Point A.

Halfway Home

Walk E to wall and through a secret door in the **tpvuifbtu** corner. Defeat Thanbor and his guards. Look at canvas bag and learn the Shield spell. Go to the eastern most door of the 2 doors in the S and enter room. Move bookcase and go through the secret door. Go to the pedestal and learn the Energy Blast spell. Go back through the secret door and to the door on the E wall to enter the Brazier Room. Go to the Silver Brazier. Light a match and then light the brazier. The party will be teleported to a corridor. Go N and E to the mist door. Pass through mist by saying Xavier backwards (REIVAX). Go S to end of hall and cast a Silence Spell to get past the Shrieking Skull and go through the S door.

A "Vial"able Ending

Evade Xavier in his chamber by running away. Go SW to door. Enter room with flasks, dishes and bowls. Look at bowls. Get vial from a bowl. Go N to room with the dragon heads. Touch dragon heads in the following order: **sfe, xijuf** and **cmvf**. Go N into the portal to teleport back to Eldritch's tower courtyard.

Ending the mission

Go to the Crystal Goblet Inn and to N table. Get the circus tickets. Return to Eldritch's room and give vial to him. He will congratulate you and offer you an ability increase. It is suggested that you take the increase in Charisma. You may talk to him right away and get your second mission.

Scenario II: Violet Valley

Farming For Clues

Go to portal in the tower and say **Wjpmfu Wbmmfz**. Cast the **Mjhiu** spell to pass through passage. Stop at cobweb on S wall and learn the Time Distortion spell. Exit the passage at the W end. Go W near farm and find Gnu Gnu. Greet Gnu Gnu and lie about your

identity. Find `tdbsfdsp` and look at it. Get corn cob pipe. Go N to Stockton Farm and open gate. Go NE to chicken coop and get magic feather. Greet Joshua and give him the circus tickets. Get the barn key. Talk to Farmer Logan.

Old and New Faces

Go N to the monastery and then NE to find the vine. Climb the vine and go through E door. Greet Old Maxwell and allow him to join the party. Climb down vine and leave treehouse. Go E and find Indunn. Greet her. Inquire about ginger roots. Go W to the Monastery. Open door. Go to the NE corner of the monastery and up ladder to enter the Vestry. Go S to bookcase and look at books. Learn the Omnivision spell. Go through S door and get holy symbol from golden altar. Leave Vestry. Talk to Brother Jenkins and inquire about stolen book. Greet Bruce Leon and pay him to join the party. Greet Brother Sidney and inquire about ginger roots. Get the ginger roots. Return to Stockton Farm and go to barn. Greet Blade Jones. Bruce Leon will free him and he will join your party.

A Day at the Beach

Go to the W edge of the beach and let Gnu Gnu build sand castle. Get green bottle. Go see the sailor Garkon with Blade Jones. After their talk, the party is taken to Ichabod Island. Enter dungeon in the `cpvmefst`. Go S and follow the corridor to the E. Go to small fountain and wait one turn. Let Old Maxwell drink from fountain and he will become Young Maxwell. Leave dungeon. Find conch shell on the SW shore. Get conch shell and blow it. The party will ride the Giant Turtle back to the beach. Go E of the entry passage to the magic carpet and let the Imp throw rotten eggs at you. Bruce Leon will catch an egg and give it to you. Pull the cork from the green bottle. Go to the center of the room and wake Jinx from sleep by dropping rotten egg. Greet Jinx and he will join the party. Return to magic carpet and let Jinx chase the Imp away. Get magic carpet.

Castles in the Sky

Cast `Tjmfodf` spell. Ride on carpet and go to castle in the clouds. Find and kill the Strato-Cumulus monsters. Go to drawbridge and let Young Maxwell open it. Enter castle and get captured by Jeb the Giant. Walk along the E wall and pull the string. Walk along the `fbtufso` wall. The maid will slip a loaf of bread in the door. Get bread and eat it. Open door with giant key and go downstairs. Go N, out the door to the W and defeat the Griffins. Go W, through a door, then through S door. The party will be teleported to the NE corner. Get boring storybook. Walk through secret door in the SW corner. Go back into the teleport chamber. The party will be teleported to the SW corner. Greet Veronica and she will join the party. Walk through a secret door in the NE corner.

Exit castle and ride carpet back to Violet Valley.

Quit "Dragon" Your Feet

Walk around until you find Charles, who will give you a cryptic key. Get it. Go NE of the entry passage to Zilch's shack. Knock on door. Greet Zilch and agree to purchase the Gnihton spell. Inquire about the Gnihton spell. Go S to the dragon cave. Go S to dragon and open the eternally boring storybook. Explore the southern sections of the cave. Find the tome in the `tpvuixftu` section and learn the Force Field spell. Go to the `tpvuiiftu` section and get Ivanhoe book and Book of Poetry. Return to Monastery and give `Jwboipf cppl` to Brother Jenkins, who will teach you the Awaken spell.

Your Place or Mine?

Go E and enter abandoned mine. Go N into the turning passage. Avoid being crushed by the boulder by running back the way you came. Head back up the boulder passage and then go E then S. Greet Imrahz and agree to help him banish the demon. Go back to ladder and then S. Turn W and go through stalactites. Find elevator and Gnu Gnu will fix it. Press button. Find Myron the demon and Imrahz will banish him. Search in the E chambers and find the mysterious writing. Learn the Recall spell. Exit mine. Go to `opsuifbtu` corner of map and enter the cyclops cave. Find and defeat the cyclops. Go S to the ledge. Climb ledge and you will get the scarlet sword. Go through the secret door S of the ladder and leave cave.

Skeletons in the Closet

Cast the `Sfdbmm` spell to the Thimble. Get Thimble. Walk on easternmost grave with a large tombstone and look at it. Get the skeleton key. Enter mausoleum using skeleton key. Open coffin and take the ladder down. Go W then N. Go past red light. After being teleported, repeat above steps and pass the light a second time. Go to the NE room. Open coffin and learn the Detect Monster spell. Go W and enter room. Enter inner room and the room will shift to reveal a ladder. Exit room and climb down ladder. Move work table under the opening. Climb up through opening. Eat ginger roots. Go through door and through room with red mist. Drop the Thimble or Feather. Go around the bend to the N. Give scarlet sword to the Scarlet Statue. Defeat the Scarlet Statue. Go W, turn N. Enter Crypt. Open majestic coffin. Greet Pierre and he will join the party. Exit Mausoleum using a second ladder to the NE of entry ladder.

All's Well That Ends Well

Go to the N of the map to the Wildwood Inn. Open door. Greet Burt and agree to spend the night. Go to SW corner of hall and enter room. Greet Jenny and agree with her. Leave the inn. Ride magic carpet and return to castle. Go to second floor. Have Pierre unlock N door into Jeb the Giant's chamber. Go

through W door. Drop the Book of Poetry. Jenny will tell a sad tale, and Jeb the Giant cries, ending the drought. Ride the Carpet. Return to the entry passage with the portal. Go to the portal and say **Fairhaven Valley**. Go to Eldritch's room and talk to Eldritch. He will congratulate you and offer you an ability increase. It is suggested that you take it in either Charisma or Intelligence. Eldritch will then give you your third mission.

Scenario III: Springdale Valley

Dressed to the Nines

Go to the portal in tower. Say **Tqsjohebmfwbmmfz**. Go W to Oscar's tailor shop. Open door. Greet Oscar and buy a vest and a black bowtie. Go to mirror. Learn the Reflection spell. Go N to the rack and wear the stylish vest. A piece of paper will fall out. Learn the Quickness spell. Leave the tailor shop.

Walk with the Animals

Find Billy the Kid. Greet him and have him join you. Frankie the goat will eat your nice vest. Get the two buttons the goat spits out. Go N to bakery. Open door and enter bakery. Talk to Charles (standing on the left). Agree to remove the werewolf curse. Talk to Elizabeth (on the right). Buy her ice skates. Leave bakery. Walk around map and set off all three rabbit traps. Enter rabbit hole. Greet Kimberly Rabbit and she will give you a carrot.

Things That Go Bump...

Go SE of the pyramid to the bat cave. Go to NE corner of cave, then S. Open the velvet case and you will get the festive flute. Go to troll bridge. Cross bridge while Billy the Kid is keeping the troll busy. Enter the cave with the blast of cool air. Go S. Walk through the ordinary wall (a secret door). Get metal rod. Walk N through a secret door to exit chamber. Go E and follow the corridor. Find and look at ice tablet. Learn the Strength spell. Follow corridor. Find the slab of ice in the Salcove. Get +1 sword by breaking the slab. Go to ladder at the E and exit cave into ice area.

A Cold Shoulder

Wear ice skates. Go S and be judged for skating. Go to igloo and clear entrance. Enter igloo. Talk to Edward the Eskimo. Cast the spell Time Distortion. Edward will give you permission to use the kayak. Go to lake and climb into the kayak. Go to the S shore and greet Franklin the Penguin. Give the black bowtie to Franklin. Go back to the N shore and get out. Go 2 spaces N of Edward's igloo. Build a snowman. Snookie will animate and join the party. Go east to the yeti and Snookie will win a snowball fight. Go through the pass, then S to ice grotto. Enter ice grotto. Go S and defeat polar bear. Go S. Search E chamber and find the giant hourglass. Blow the silver flute. Azersun will join the party. Go around the bend and find tattered sheet of paper. Learn the

spell Depoison. Leave ice grotto. Return to entrance to ice area. Enter cool cave. Go W. Snookie will stay behind. Go back to Springdale Valley.

Time and Time Again

Cross W over troll bridge and Billy the Kid will rejoin party. Greet Azersun and agree to shift time to the past. Go E and defeat the werewolf. The werewolf will become Malcolm. Malcolm will join the party. Go W to the pyramid (now intact). Malcolm will find a secret entrance. Follow Malcolm into pyramid. Cast the spell Detect Monster and Light. Cast the spell Time Distortion before the Devourer is at the door. Go through Devourer's room as quickly as possible. Go W and up ladder. Go S into lightning room. Exit lightning room to the W. Go up ladder. Go E. Turn off Light spell. Go through shadow room by going two moves S and one move W. Cast the Light spell. Go up ladder. Get pot of gold from altar. The pyramid will collapse, and the party will be placed outside.

Watsamata U.

Go W to wigwam and open flap. Greet Alphonso the Witch Doctor. Exit wigwam. Go NE of the pyramid to the **mfqsfdivbo** tree. Knock on the knot. Greet Lucy and give her the **qpu** of **hpme**. She will give you the diploma. Return to wigwam and give diploma to Alphonso. Go NW and find bottle in river. Break bottle. Learn the spell Unparalyze. Greet Azersun and agree to shift time to the present.

It's Pop Quiz Time!

Return to bakery. Open door. Talk to Charles and he will give you an amazing map. Leave bakery. Greet Azersun and agree to shift time to the past. Go to the SW corner of map. Enter the Wizard's Enclave. Cast the following spells: **Mjhiu**, **Efufdu Npotufs**, and **Ujnf Ejtupsujpo**. Go through bouncer room and exit NE. Go SE and Greet Alizarin. He will use you as a volunteer. After passing the test, go into next room. Greet Victor. Cast **Fofshz Cmbtu**. He will tell you to take final exam. Go W to Sinth's room. Greet Sinth. Say **opuijoh**. Say **gjuguffo**. Say **uijncmf**. Go W into library. Go to Spedestal. Learn all known noncontinual spells. Go to W pedestal. Learn all known continual spells. Leave the Wizard's Enclave. Greet Azersun and agree to shift time to the present.

Icing on the Cake

Return to portal. Cast **Tusfohuifo Qpsubm**. Say **Wjpmfu Wbmmfz**. Cast **Tusfohuifo Qpsubm**. Say **Gbjsibwfo Wbmmfz**. Rest. Cast **Tusfohuifo Qpsubm**. Go to Eldritch's chamber. Greet Eldritch. He will congratulate you and offer you an ability increase. It can be used on any statistic. Eldritch will proclaim you to be a wizard, and you will then be shown opening your own tower for students.

Map Key: Tangled Tales

The locations of some objects and all spells do not appear on the maps but are easy to find from the descriptions below. Note that when a spell's name is **boldfaced**, a puzzle or obstacle must be overcome before access to spell is possible—this is *not* done for objects. An "S" indicates position of stairs on all maps.

Scenario I: Fairhaven Valley (map one)

- A: Weapons & Armor
- B: Shovel
- C: +1 Leather
- D: Porridge
- E: 50 Gold Pieces
- F: Weapons
- G: Jail Keys
- H: Diamonds
- I: Coal
- J: Vial
- 4: (on main map): Apple seeds

Room names in Xavier's Fortress

- 1: Entry
- 2: Barracks
- 3: Armory
- 4: Dining Room
- 5: Pantry
- 6: Blue Light
- 7: Daconda's Room
- 8: Thanbor's Room
- 9: Bookcase Room
- 10: Cells
- 11: Pedestal Room
- 12: Alchemy Room
- 13: Xavier's Room
- 14: Brazier Room
- 15: Portal Room
- 16: Mist Door

Items not shown on map

In Fairhaven

- | | |
|----------------|---------------------------------|
| Bucket | Buckets by the Bundle shop |
| Box of Matches | Tavern kitchen |
| 40 Gold Pieces | Barrel in Tavern basement |
| Brochure | Moe's Magic Shop |
| Blue Key | Fountain just inside city gates |

Near Xavier's Fortress

- | | |
|------------------------|-----------------------------|
| Nightcrawlers & Apples | Garden (E of entry to Fort) |
|------------------------|-----------------------------|

Spells

- | | |
|--------------|---|
| Light | Library table (2nd floor of tower) |
| Heal | Bookshelf in Drek's bedroom |
| Fear | Haunted house |
| Silence | Three Bear's house |
| Energy Blast | Room behind bookcase, Xavier's Fortress |
| Shield | Thanbor's room, Xavier's Fortress |

Scenario II: Violet Valley (map two)

Dotted lines in Mausoleum are original position of sliding room.

- A: Loaf of Bread
- B: Giant Key
- C: Boring Storybook
- D: Ivanhoe Book, Book of Poetry
- E: Scarlet Sword
- F: Charles' Fiance
- G: Fountain
- H: Scarlet Statue
- I: Dragon
- J: Elevator
- K: Demon
- L: Teleport Chamber
- 8: on main map: Rotten Egg, Magic Carpet
- 10: on main map: Green Bottle

Items not shown on map

- | | |
|---------------|-------------------------------|
| Corncob Pipe | Scarecrow near Stockton farm |
| Magic Feather | Chicken coop at Stockton farm |
| Barn Key | Dropped by Joshua at farm |
| Holy Symbol | In altar room in Vestry |
| Ginger Roots | Given by Brother Sidney |
| Thimble | Mausoleum Graveyard |
| Skeleton Key | Eastern grave in graveyard |
| Conch shell | SE corner of Ichabod Island |
| Cryptic Key | From Charles |

Spells

- | | |
|-----------------|---------------------------------|
| Time Distortion | Entry passage |
| Omnivision | Bookcase in Vestry at Monastery |
| Force Field | SW chamber in Dragon cave |
| Gnihton | Purchased from Zilch |
| Awaken | Taught by Brother Jenkins |
| Recall | E chambers of Demon's lair |
| Detect Monster | N chamber of Mausoleum |

Scenario III: Springdale Valley (map three)

- A: Festive Flute
- B: Metal Rod
- C: 6+1 Sword
- D: Pot of Gold
- 2: (on "past" map) :Diploma
- 4: (on "present" map) :Carrot
- 5: (on "present" map) :Nice Vest, Black Bowtie
- 8: (on "present" map) :Ice Skates, Amazing Map

Items not shown on map

- | | |
|-------------|--------------------------------|
| Two Buttons | Outside when goat eats vest |
| Bottle | NW in river NW of outdoor past |

Spells

- | | |
|-------------------|---------------------------------|
| Reflection | Mirror at the tailor shop |
| Quickness | Vest on rack at the tailor shop |
| Strength | Ice tablet in the cool cave |
| Depoison | S chamber in ice grotto |
| Unparalyze | Bottle in river in past |
| Strengthen Portal | Library in Wizard's Enclave |

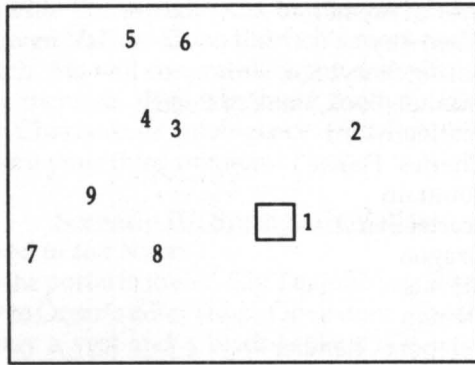

Fairhaven Valley

- 1: Fairhaven Village
- 2: Goblin Cave
- 3: Hollow Tree
- 4: Rabbit Cage
- 5: Three Bears' House
- 6: Slime Pool
- 7: Boulder/Xaviera's Fortress
- 8: Gypsy Hut
- 9: Garden

Goblin Cave

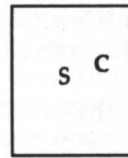

Level Zero

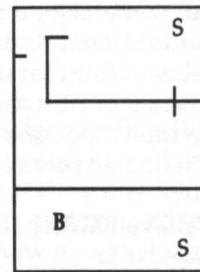

Level One

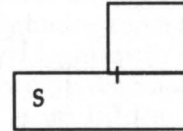

Level Zero

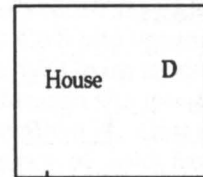

Three Bears' House

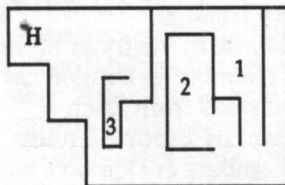

Slime Pool
(Repton Cave)

- 1: Entry Chamber/Exit
- 2: Statue Room
- 3: Repton Chief

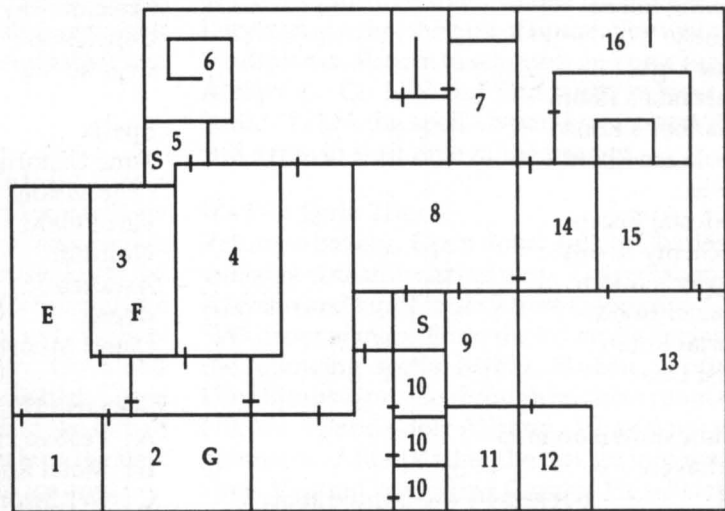

Xavier's Fortress

Eldritch's Tower

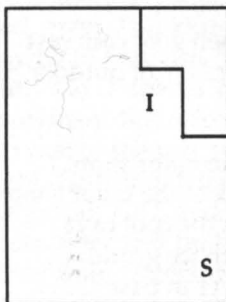

Basement

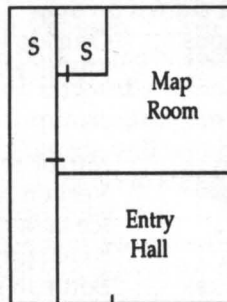

Level One

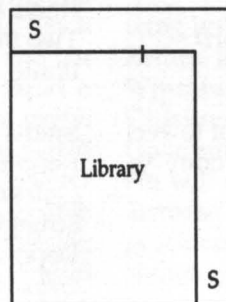

Level Two

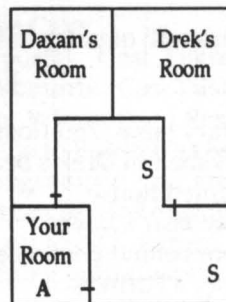

Level Three

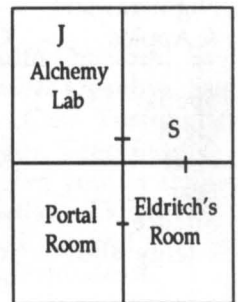

Level Four

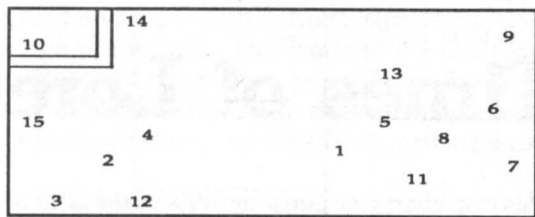

Violet Valley

- 1: Entry Passage
- 2: Stockton Farm
- 3: Scarecrow
- 4: Monastery
- 5: Zilch's Shack
- 6: Induun
- 7: Abandoned Mine
- 8: Magic Carpet
- 9: Cyclop's Cave
- 10: Beach
- 11: Dragon Cave
- 12: Hidden Ladder to Mausoleum
- 13: Vine to Treehouse
- 14: False Vine
- 15: Dry Well

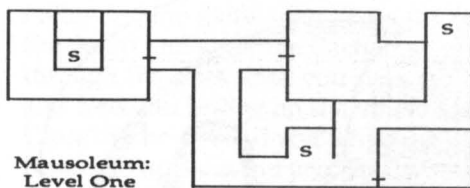

Mausoleum: Level One

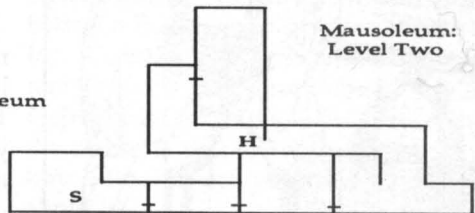

Mausoleum: Level Two

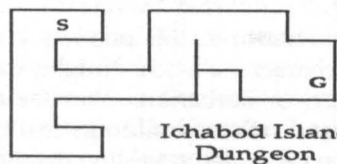

Ichabod Island Dungeon

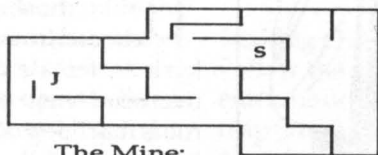

The Mine: Level One

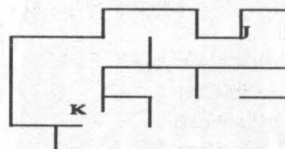

The Mine: Level Two

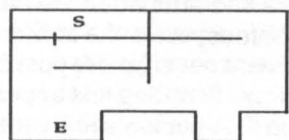

Cyclop's Cave

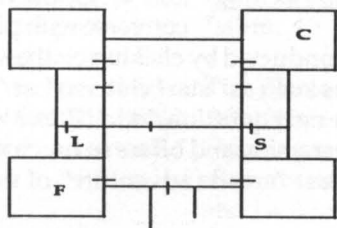

Giant's Castle: Level One

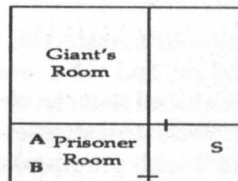

Giant's Castle: Level Two

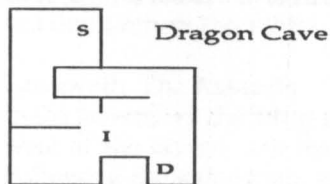

Dragon Cave

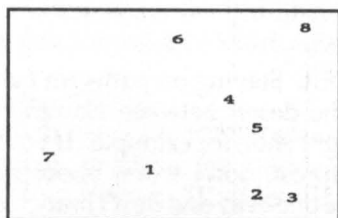

Present

- 1: Portal
- 2: Troll Bridge
- 3: Cool Cave
- 4: Rabbit Hole
- 5: Tailor Shop
- 6: Pyramid
- 7: Bat Cave
- 8: Bakery

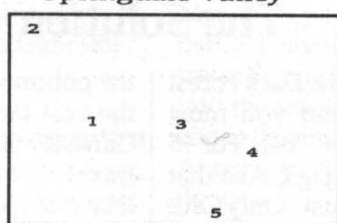

Ice Area

- 1: Igloo
- 2: Cool Cave
- 3: Yeti
- 4: Ice Grotto
- 5: Penguin

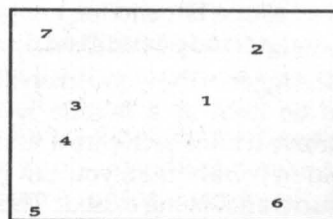

Past

- 1: Pyramid
- 2: Leprechaun Tree
- 3: Wigwam
- 4: Lumber Pile
- 5: Wizard's Enclave
- 6: Bridge
- 7: Bottle in River

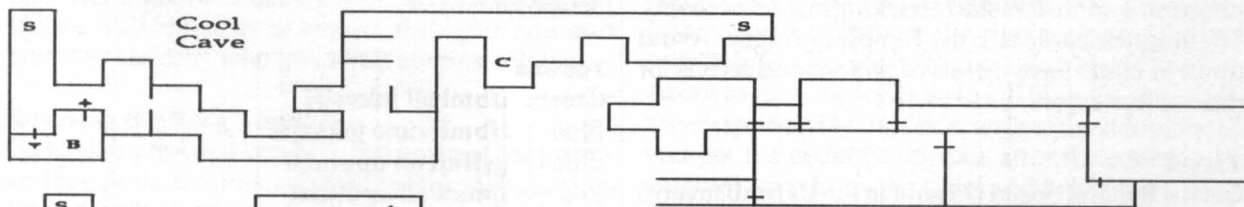

Wizard's Enclave

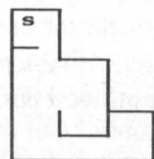

Ice Grotto

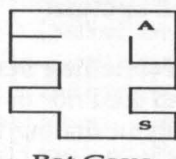

Bat Cave

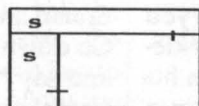

Level One

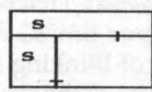

Level Two

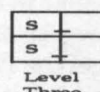

Level Three



Level Four

Pyramid (past)



Times of Lore

This one-character quest unfolds in the land of Albareth more than twenty years after King Valwyn retreated to another part of the realm to recuperate from his recent victory over an invasion of barbarian hordes. The barbarians are back, but the King isn't—so it's up to you to round up the Foretelling Stones, Tablet of Truth and other items needed to save the day.

Unlike most action adventures, this one lets you choose from three character classes: Knight, Valkyrie (a female character) or Barbarian. You see an overhead view of the land, whose buildings feature roofs that "pop off" when you enter, revealing detailed interiors. While the graphics and animation are crisp and vivid, the most impressive aspect is the ability to converse with people to an extent never before possible

in an action adventure. Conversation is conducted by clicking on the appropriate icon. Scrolling text appears in a window, and sub-menus list options such as "start chitchat" or "ask question." A person's reply often contains a word that can be used in your next question, as in *Ultima V*. The music is a knock-out on the C 64 version. Because it stresses character interaction and offers so much more to do than just shoot things, *Times of Lore* (a British program) is easily the best "arcade adventure" of the decade.

Type: Fantasy Arcade Role-playing

Skill Level: Intermediate

Systems: Apple (64K), C 64/128, IBM (joystick required)

Company: Origin/Broderbund

The Solution

Combat

The dagger in the woodsman's hut in the Dark Forest can be used as a missile weapon, but you must retrieve it after each throw and is easily lost. For 95 gold in *Mbolxfmm*, you can buy a Magic Axe that returns after being tossed. This is a must. Only Orcs and robed Thieves carry potions, scrolls, money and food, so kill them whenever possible. Avoid skeletons and ghosts if possible, since they carry nothing. Never kill civilians in towns, since everyone will be on your case for the rest of the game. As the game progresses, monsters start attacking inside the towns. The toughest battle is in the Temple of Angor. Avoid *npolt jo xijuf*. Save up lots of potions and scrolls for this confrontation.

Travel

Get the Boots of Speed (75 gold in the *Usffmb* tavern) to double your speed. The Scroll of Transportation (on a downstairs table in *Rgzcnvodzj*) teleports you to any town but works only three times. After destroying Lyche, get the Potion of Blinking from his throne; when you drink it, it "blinks" the character in the direction he's facing until he hits an obstacle or

the potion wears out. Staying on paths isn't always the best tactic. The desert between Hampton and Ganestor is a straight shot, for example. If you must travel through a forest, don't worry about getting lost: most paths are one-way and don't branch off, so if there's a way in, you can probably get through. After making progress, save the game by spending a night in a tavern. If you lose a vital item or get hopelessly trapped, let yourself get killed, then reboot and start over. Buy food regularly, especially before long trips.

Potions

Green: *ifbmt all jokvsjft*

Blue : *ifbmt some jokvsjft*

Blue : *gsffaft all npotufst*

Red : *ljmmt all npotufst*

Eralan and the Foretelling Stones

Go downstairs to the Prior in the southwest corner and say "Yes" about finding the Stones. Get food from the bar and head north from town into the Dark Forest. You'll soon find the woodsman's hut. Ask

about orcs and camp. Go past a little lake further up the road and turn north to find a small trail running through the woods. This leads to the Orc's camp. Slay them and get the urn, which holds Stones. Return to the Eralan Inn and give them to the Prior, who pays you and sends you to see the Regent in the castle.

The Tablet of Truth

After the Regent tells of the Tablet, go to Ganestor. (If you want to rest or buy food, the Last Hope Inn is on a southern path halfway between Eralan and Hampton.) In Ganestor, enter the long thin building west of the tavern and chitchat with the serf. Ask about the **tfdsfu xbz**. Now enter Barton's hut (due south of the tavern) and ask him about the **tfdsfu xbz**, then about the **uvoofm**. Enter the tavern and ask him of the **uvoofm**, and he'll tell you about the secret entrance into the castle. Go down the stairs behind the bar and into the room in the cellar's **opsuifbtu dpsofs**. Brush the lever on the north wall to open the secret stairs in the floor. Take them down. You emerge in the northwest corner of the castle dungeon. Avoid guards, since fighting them here leads to serious problems. Sneak to the stairs on the far east side and go up to the ground floor. On the west side, find the room with the Tablet and get it. Ask it about the **ijhi ljoh**. Examine it. Return to the tavern via the secret way, but don't return the Tablet.

Lankwell: The Assassin

In the tavern, ask the Thug about **btbtjtjo**. In the hut west of the tavern, ask the serf about **cmbdl btq**. Following the game map, cross the bridge over the river south of Lankwell. Enter the hovel on the far side and ask about the **ijhi ljoh**. After his story, he gives you a scroll for Heidric. Return to Ganestor.

Catching the Spy

Return to the castle via the secret way in the tavern basement, avoiding the guards. On the top floor, you'll find Heidric. **Hjwf ijn uif tdspmm** and learn of the spy. Leave the castle through the front gate, which you can now use instead of going through the dungeon. In the tavern, talk to the Innkeeper for a clue. Then ask Barton (in his hut) about **tofbljoh**. Later that night, wander around in the castle. When you find a guard sneaking around, ask him about **tqzjoh**. Kill him after he attacks, then grab note and take it to Heidric, who gives you another mission.

Rescuing the King's Son

Go to Hampton and enter the hut north of the tavern and beside the mountains. Ask the Duke about **dsjnf**. Head for Shadowpeak (east of town, found by following the edge of the mountain ranges). Kill the guard in Shadowpeak and get the green key. Go upstairs and waste that guard. Use the green key to unlock the cell holding the boy, who tells about the Royal Wizard, Irial.

Irial the Wizard

Following the game map, cross the bridge north of the desert and enter the Enchanted Forest. Wander through the trees until you pass the hunter's cabin and a second bridge on the other side of the forest. Cross this bridge and you'll find the Wizard's tower. Inside, go upstairs and you'll learn how to slay Lyche (**ipmz xbufs**). Exit and go south to the east-west path between Eralan and Hampton to find the Last Hope Inn. Ask the man who talks about the ruins about temple, lyche and **ipmz xbufs**. He'll send you to **Gsjbs Lbjof** in **Sizefs**. Find him in the hut north of the tavern in that town. Ask about **ipmz xbufs** and buy it (make sure you have 25 gold before asking about it).

Lashing Out at Lyche

Follow the game map to the ruins in the desert and enter the doorway in the rubble. See the Desert Ruins map (provided here) and follow the exact order shown for the safe path across blue plates on the floor. Use **ipmz xbufs** on Lyche, get the potion, exit and **wjtju Jsjbm**.

The Blasted Spot

After Irial tells you of the Medallion and the Chime of Opening and gives you a key, go to the Blasted Spot, a huge crater at the three-way junction between Eralan and Lankwell. Use the key (from Irial) on the door in the center. Follow the Blasted Spot map to cross the pressure plates and reach the Chimes. Get them, go to Treela and check in at the Inn to save the game.

The Temple of Angor and the Medallion of Power

Make sure you have lots of potions and scrolls for this battle. Leave Treela **wjb bo bftufso qbui** through the trees, turn north along the mountains, go west back into the trees and you'll emerge just under the lake above the Enchanted Forest. Go east to the Temple of Angor (on the game map). Avoid the monks outdoors, enter the temple and run to the north wall. Use scrolls to slow down the skeletons. Climb the stairs to the top floor and slay the monk dressed in blue, who drops a white key. Get it and run back downstairs to the front door. Turn west and enter the little room. Find the hidden lever on the north wall. **Csvti ju**, and a secret staircase to the dungeons will appear. Run downstairs and use the **xijuf lfz** to free the prisoner below. Say yes to his question about the Grey Abbot to get a clue on how to kill him. Go upstairs to the **cfesppn** on the top floor, walk to the side of the **cf** and get the **tqifsf** (it appears after the command is entered). Go down the stairs and to the right. Walk up to the Evil Cleric on the throne and use the **tqifsf** to wipe out him and the Abbot. When the Medallion appears, get it.

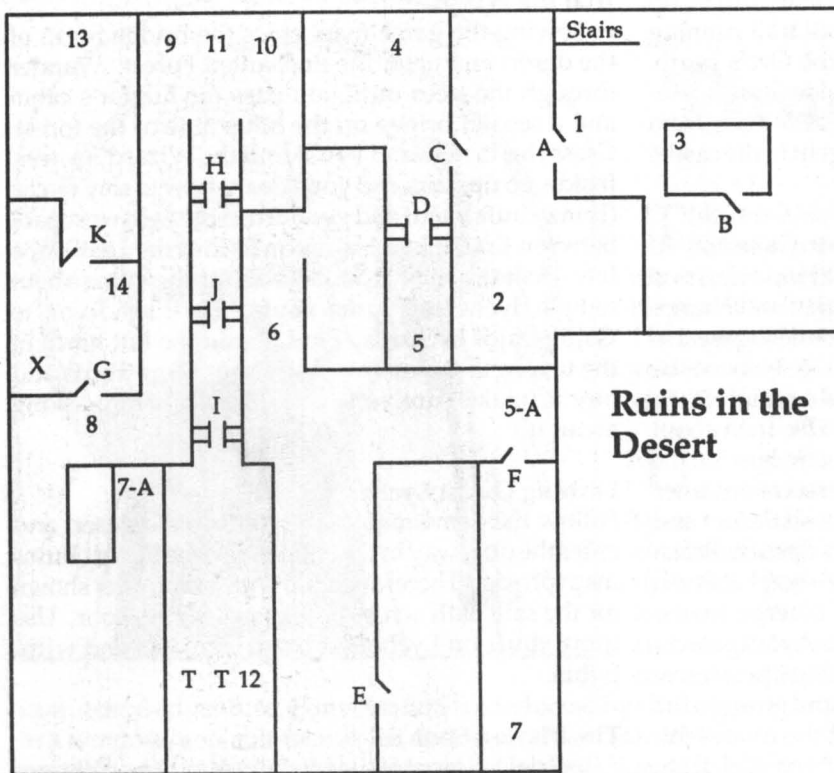

Ruins in the Desert

Map Key: Times of Lore
Follow the numbers to cross tele-
port pads and open doors and
bridges in correct order.

Ruins in the Desert

- 1 : Opens door at A
- 2 : Opens door at B
- 3 : Opens door at C
- 4 : Opens bridge at D
- 5 : Teleports to 5-A
- 6 : Opens doors at E & F
- 7 : Teleports to 7-A
- 8 : Opens door at G
- 9 : Closes bridge at H, opens
bridge at I
- 10: Opens bridge at H, closes
bridge at J
- 11: Opens bridges at J
- 12: Opens door at K
- 13: Lyche
- 14: Teleports to stairs
- T : Trap
- X : Closes door at G

The Blasted Spot Dungeon

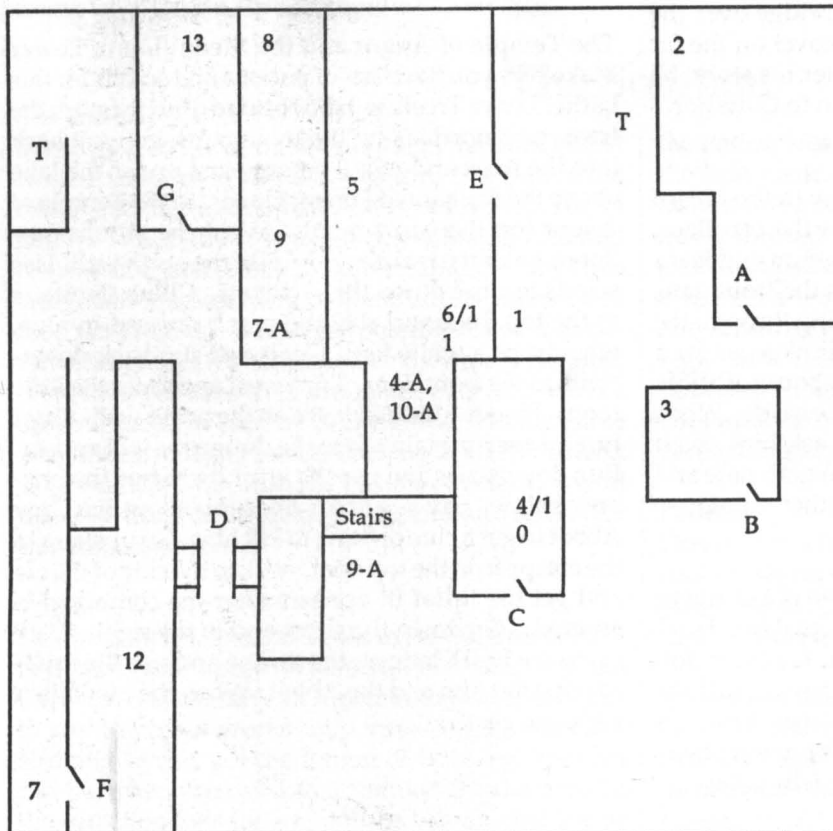

Blasted Spot

- 1 : Opens door at A
- 2 : Opens door at B
- 3 : Opens door at C
- 4 : Teleports to 4-A
- 5 : Closes bridge at D, opens
door at E
- 6 : Opens bridge at D
- 7 : Teleports to 7-A
- 8 : Closes bridge at D, opens
door at F
- 9 : Teleports to 9-A
- 10: Teleports to 10-A
- 11: Opens bridge at D
- 12: Opens door at G
- 13: Chimes (If bridge is missing
after you get the chimes,
cross teleport 7, then 9 to
escape.)
- T : Trap

Tower of Myraglen

In this one-character swords and sorcery challenge, you're a knight who must enter a tower and retrieve a hidden medallion that will restore peace to the world. Besides ferreting out keys, solving puzzles and wiping out monsters, you also have to prove yourself good and pure in order to fulfill the mission. As the story unfolds, you're presented with decisions such as whether to steal gems, or give gold to the needy—choices that affect your potential for success. Combat is unimaginative, but the game is rich in well-designed riddles and puzzles, some of whose solutions involve manipulating music boxes, statues and other objects. Stereo sound effects enrich the vivid graphics, which show each room from an aerial view. The first role-playing game created exclusively for the IIGS, *Myraglen* offers pull-down menus for inventory management and common actions such as take. These features simplify game-play, which is well-balanced: not too easy, but not so hard you'll give up before completing the quest.

Type: Fantasy Role-playing
Skill Level: Intermediate
Systems: IIGS
Company: PBI Software

The Solution

Do not enter rooms labeled in **boldface** on the maps.

Level One

At (A), look toward mirror. Walk around the floor at (B) to find a scroll. At (C) you'll find a Jeweled Electrum Key. Look toward the fireplace at (D) when the clock strikes midnight to get a Gold Key. Avoid the Fire Room at (F). Don't take the statue at (G). You'll meet Apparitions at (H) and (I).

Level Two

At (A), Yell/Talk Gbejoh bxbz before getting to Gargoyle. Don't take the gold at (B). Apparitions are at (C) and (D). Yell/Talk Tfswp Efwz Vovn to get the Platinum Key at (E), which is needed at (F). Avoid the sphere at (G). More Apparitions at (H).

Level Three

At (A), Yell/Talk Zft. After entering (B), go E, S, E, E, S, then East until entering (C). Go E, E, N, E, N, E, E and get the Jeweled Gold Key at (D). Get the Sea God Statue at (E).

Level Four

At (A), step on the squares when they're xijuf and you won't be harmed when uifz uvso cmbdl. Sit on throne (B), get Ring of Fire Resistance in exchange for Sea God Statue. Bwpje (C), the Indescribable Beast. At (D) is Fire. Avoid (E), a Dragon.

Level Five

More Apparitions at (A). Yell/Talk Ljoh at (B). Coffins turn to fire when you enter room (C). Give all your gold at (D).



Level Six

At (A), don't use the doors—go through hidden doors. Don't take the Scarab from the chest (B). Take from feeding trough (C) to get Mendalick's Beliefs. Avoid (D), the Room of Darkness. You'll find a Medallion at (E). Avoid Gorgons at (F).

Level Seven

Get the Jeweled Copper Key (A) and the Jeweled Music Box (B). Stay next to the jotjef x bmm at (C) to enter Teleporter with minimal combat.

Level Eight

Get the Jeweled Silver Key (A). At (B), hjwf bmm gold (take all gold from level before going to next level). Get the Jeweled Platinum Key (C).

Level Nine

Go straight to the stairs to Level Ten. At (A) you need the gjwf Kfxmfe Lfzt and Mendalick's Beliefs.

Level Ten

At (A) you need the Nvtjd Cpy to pacify the Dragon. Go directly to (D) and Yell/Talk No. Then go straight to (E). Take Medallion. Answer No, No, Yes. (Fire is at (B), white/black squares at (C).)

Map Key: Tower of Myraglen

Level One

- A: Mirror
- B: Scroll
- C: Electrum Key
- D: Gold Key (at midnight)
- E: Need Gold Key
- F: Fire Room (avoid)
- G: Statue (don't take)
- H & I: Apparitions

Level Two

- A: Near Gargoyle
- B: Gold (don't take)
- C & D: Apparitions
- E: Platinum Key
- F: Need Platinum Key
- G: Sphere (avoid)
- H: Apparitions

Level Three

- A: Yell/Talk Zft
- B: Entrance
- C: Entrance
- D: Jeweled Gold Key
- E: Sea God Statue

Level Four

- A: White/black squares
- B: Throne, Ring of Fire Resistance
- C: Indescribable Beast (avoid)
- D: Fire (avoid)
- E: Dragon (avoid)

Level Five

- A: Apparitions
- B: Ljoh
- C: Coffins
- D: Give all your gold

Level Six

- A: Hidden doors
- B: Scarab in chest (don't take)
- C: Feeding trough, Mendalick's Beliefs
- D: Room of Darkness (avoid)
- E: Medallion
- F: Gorgons (avoid)

Level Seven

- A: Jeweled Copper Key
- B: Jeweled Music Box
- C: Teleporter

Level Eight

- A: Jeweled Silver Key
- B: Give all gold
- C: Jeweled Platinum Key

Level Nine

- A: Need the five Jeweled Keys and Mendalick's Beliefs

Level Ten

- A: Dragon (need Music Box)
- B: Fire (avoid)
- C: White/black squares
- D: Yell/talk No
- E: Medallion

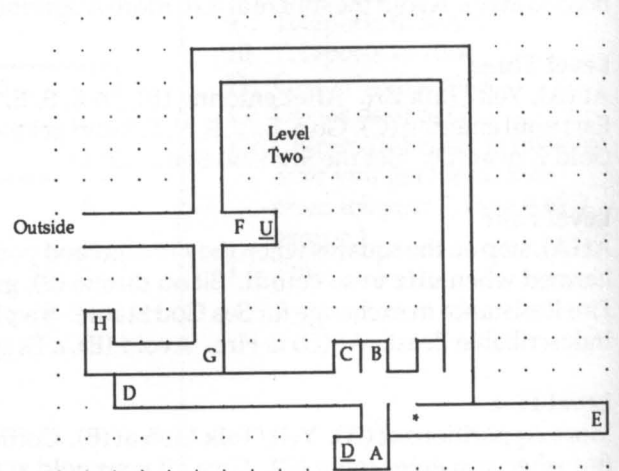
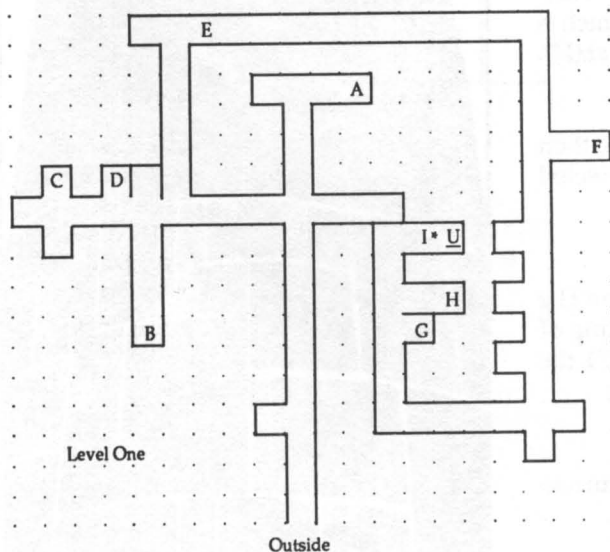

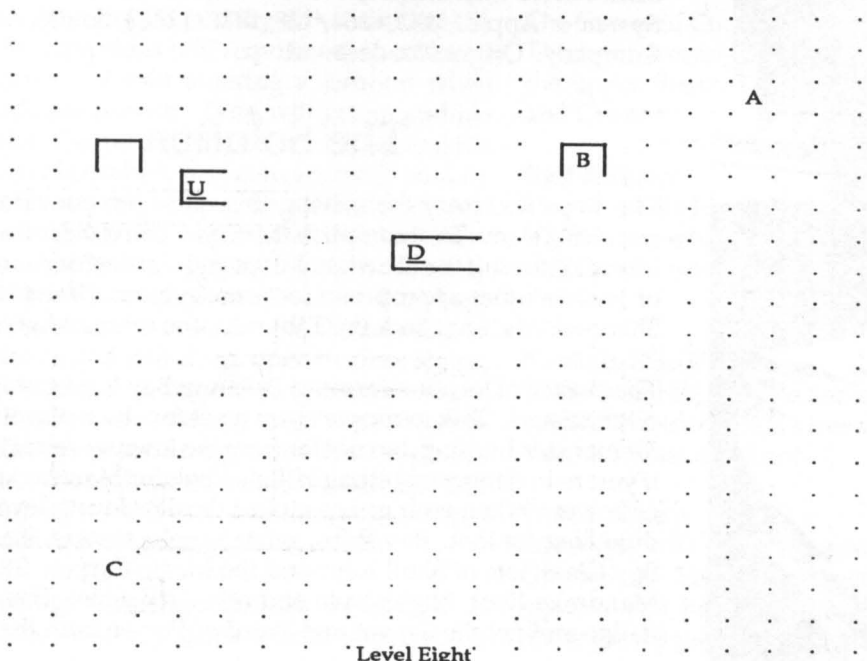
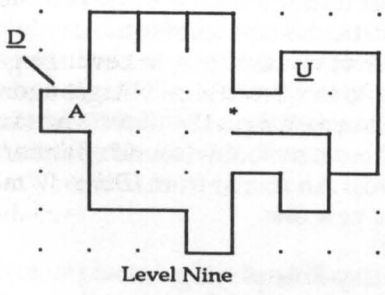
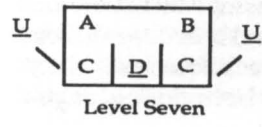
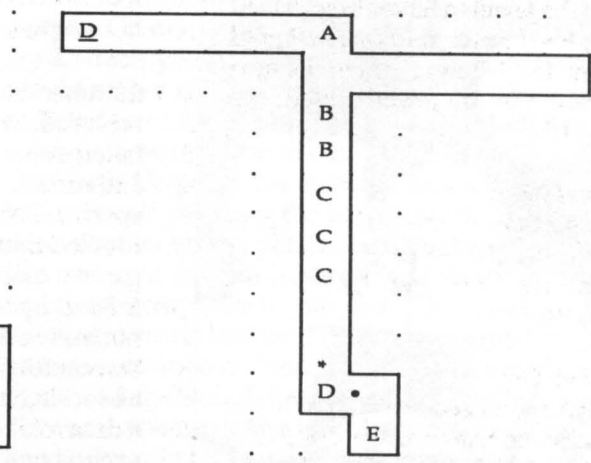
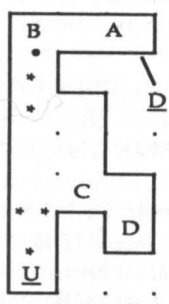
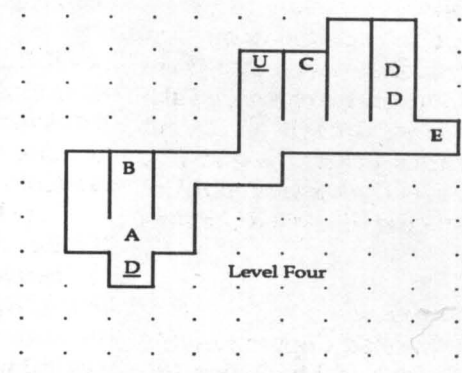
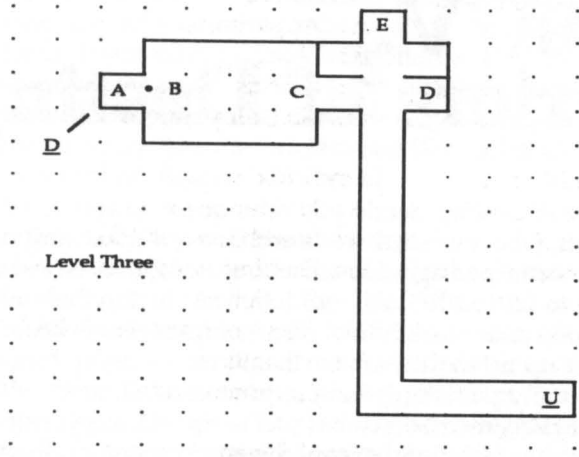

Key
U = Up
D = Down
* = Door disguised as wall
• = Door appears after correct answer

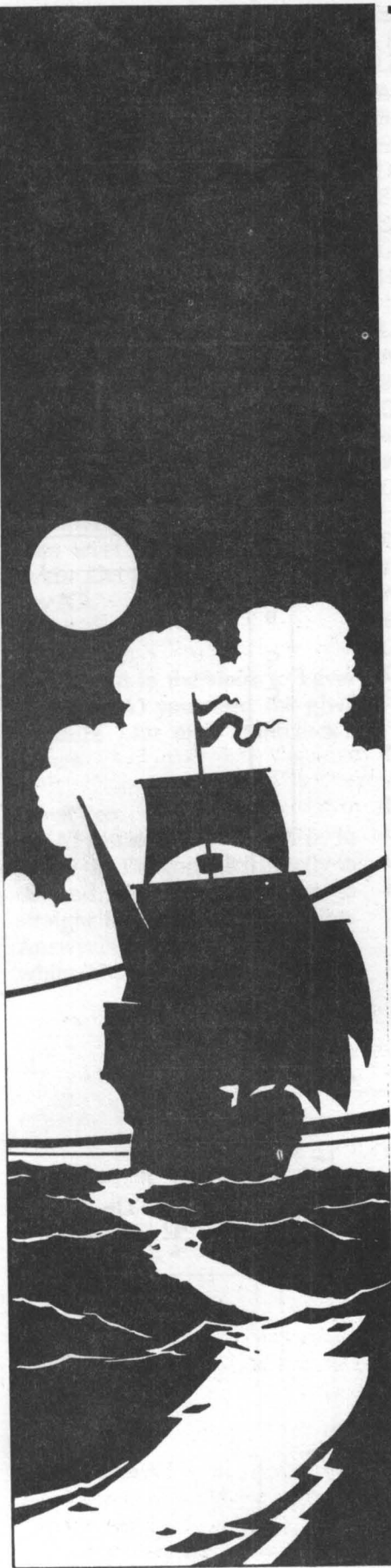

Ultima V: Warriors of Destiny

Warriors of *Destiny* sends you on a quest to rescue Lord British, who vanished while exploring a sprawling network of subterranean passages formed when the Codex was brought to the surface in *Ultima IV*. An evil band of Shadowlords now roams the land, and Blackthorn, who assumed Lord British's throne, has set up an Inquisition to "help" the citizenry become Avatars by brutally punishing them for unAvatarish deeds. You and your seven party members (who must be recruited as you quest along) are enemies of the state, so you've got to keep your eyes over your shoulder at every turn, lending the story a Robin Hood versus the Sheriff of Nottingham feel.

Though peopled by many of the same characters from *Ultima IV* and set in the same land (Brittania), *Ultima V*'s innumerable innovations give it a unique atmosphere. The geography covers four times as much space as *Ultima IV*, buildings are taller, a new kind of tile graphics affords sharp detail and a 3-D feel, and certain aspects of combat have been improved. Most of the 26 spells are from the previous game, but you must learn Latin-style root words and combine them (by pressing keys) to cast spells. The game's most intriguing aspect is that every character in the land follows a particular schedule (so the day/night cycle is a key factor, not just a clever visual effect), imparting a genuine sense of life and community to these medieval villages and towns. With 128K and a Mockingboard, Pathport Midi or Phasor sound board, you'll hear a dozen different melodies (sound effects are less effective without such a board). An Avatar from *Ultima IV* may be imported, or you can create a new one.

Type: Fantasy Role-playing

Skill Level: Intermediate

Systems: Apple (64K), C 64/128, IBM (128K), Amiga

Company: Origin/Broderbund

The Solution

The steps necessary for solving this quest are provided here in summary form. To accomplish them, you can either talk to people for clues, consult the "Townes, Keeps and Castles" section for hints, or look in other appropriate sections (such as "Vanquishing the Shadowlords") or check the Tables for the exact answers.

The cluster of locations around Brittany Bay is probably the best place to start. Talk to *everyone* you meet for clues. Go out at night for monster-hunting, but not far from the towns—retreat to a town if you're in danger of getting killed. Look for Mantras and Words of Power. When your group attains third or fourth level, explore dungeons for loot. Buy ships, get a grapple, sextant, Black Badge, Spy Glass, lots of Skull Keys and the Magic Carpet. Stock up on Mandrake Root, Nightshade and other reagents. Use the Black Badge and get the Crown and Word of Power from the prisoner.

While seeking one of the Shards, get the Mystic Armor. Get all the Shards and names of the Shadowlords. Learn what to do with the Shards. Destroy the Shadowlords and find their Keep. Get the Sceptre and Amulet. Complete all the Shrine Quests if you haven't already. Get the Sandalwood Box and stock up on supplies. Rescue Lord British.

Character Creation and Development

The keys to character development lie in the Shrines and in living up to the virtues. Don't take food or crops, kill innocent people or do other unAvatarish acts that will cost you points in a related Virtue and inhibit some characters from giving you clues. To boost Compassion, give one piece of gold to beggars. Never lie or boast (say no when asked if you're proud of something, unless asked if you are the *most* humble). To boost Karma, complete a Shrine Quest, then return to that Shrine and give gold. People who will join the party are mentioned in the "Townes, Castles and Keeps" section and in the Tables. Release prisoners in Blackthorn or Yew.

Combat & Magic

Slings and Bows will serve you well until you get Magic Axes. You can equip with more than one weapon, such as a Magic Ax and a Short Sword. A Bow is good until you get a Magic Ax. Don't forget you can fire missile weapons diagonally this time. Use them until the enemy is within arm's reach. Step back as the enemy approaches, and they'll move into better positions for you to hit them. Line your team up in a pair of columns, keeping missile weapons and Mages in the back.

General Information

You will be able to reach most places by foot, horse or Magic Carpet. The In Por spell and the Grapple are essential for traveling, especially when seeking the Shards. The exceptions will require a ship or travel by Moongates. Avoid entering a location when Shadowlords are present. (You will get an audible warning; also, the trees will be bare of foliage and the inhabitants will be reluctant to converse with you. By using a telescope at night, you can see the location of the Shadowlords.) Some locations have locked doors or moats preventing entry during the night. You may have to wait until daylight, cross moats on the Magic Carpet, or find secret entrances. Inhabitants follow certain routines and will sleep, open or close shops, have lunch and so on only during certain hours. Generally it is best to "hole up" outside until morning. This also gives you an opportunity to revitalize spell points, heal and sometimes be visited by Lord British, who may reward you or caution you to follow a certain path to meet your goals.

Barkeepers will give you useful clues for a price. If short of cash, save the game before you bribe a

barkeep; get the information, then restore game. This may not seem Avatarish, but in the early stages of the adventure you must be prudent at times. Secret doors are marked with white dots in the walls, but these are harder to see on the IBM version. A ship is needed to reach some places; consult the map before setting out for a new location to see if this is the case.

Townes, Castles and Keeps

Lord British's Castle

This castle has five levels: four aboveground and one below. Like most locations, it can be plotted on a 32 X 32 grid. On the ground level (near the stable), talk to Treanna. You may find items by searching the level below, where you will find an Armoury and items to be picked up by searching (but don't fight any Guards here). And don't take anything from the locked room down there, since it belongs to Lord British. On one level above you may find an "orb" with which you may view the floor the way you would with a gem. On the second level above you will find Lord British's quarters. (Use a Skull Key to enter, or blow the door off with the cannon). Here lies the Magic Carpet at the entrance and a secret door that opens if you play the harpsichord. The secret door permits you to obtain the *Tboebmxppe Cpy*. (Do not save the game here!) You may also meet Saduj, who may offer to join you. (Don't let him: he may cause you to lose the *Tboebmxppe Cpy*.) In this room you can also go through the fireplace to a secret place. Going through fireplaces costs you hit points so be sure you can take a few hits coming and going. The stairway in LB's quarters leads to an observatory with a telescope. Don't go to the roof unless you have Skull Keys.

Brittain

The Towne of Compassion has an Inn and Armoury. There are sleeping quarters, terrace and a balcony on the upper floors. Talk to Anon, Greyson, Terrance and Guenno.

East Brittany

Here there is a Healer and a Shipwright. Plans for the HMS Cape, which permit faster sailing aboard frigates, are in one of the draws in the Shipwright's quarters.

North Brittany

There is an Inn, a Stable and a small garden. A little north of the entrance is a tree stump with three gems. Talk to Joshua and Leaf.

West Brittany

Here you will find two gardens, a Tavern and a Graveyard. The gravestones have humorous epitaphs if you have the patience to decipher them. Some graves yield corpses and loot if searched.

Blackthorn's Palace

Located on an island west of the southern tip of the Isle of the Avatar, the palace is surrounded by a moat. You must be equipped with the Magic Carpet to avoid some of the trap doors inside. Hug the walls when going through the palace, because the traps are normally centered away from walls. If captured by guards you will be taken to Blackthorn, asked to reveal the Mantra of a Shrine and whether you do or don't, the second man in your party will be tortured and killed. It is best to avoid detection. There are three levels above and a basement level from the ground floor. On the top level in the center of the grid you will find the Crown of Lord British. When worn, it protects you from magic spells. You can avoid being captured by knowing the password and wearing the **Cmbdl Cbehf**. If captured after obtaining the Crown, you can escape in the following manner: In the dead of night, go to the down ladder at the northern central part of the top level. Go down to the bedroom and south to the wall and search for the secret door. Take the down ladder on the other side of the door, then search north for another secret door. Take the down ladder on the other side of the door and you will be on the main level. Go directly north through the triple doors, and the Magic Carpet will get you over the stream.

Bordermarch

On the upper level, you will meet Dupre and Senti, a pair of Fighters you should chat up. Talk to Sir Simon and Tessa for valuable information; an Armoury is available.

Buccaneer's Den

This location has a Guild, Armoury, an Inn, a Tavern and a Shipwright. Talk to Scally. You meet Geoffrey, an old friend who wants to join you. Sven gives clue on where to obtain a glass sword. (It's a powerful weapon but disintegrates when used, so it may not be worth searching for.) You can get information on a grapple for a drink for a woman.

Cove

Cove is southeast of Locklake and may be reached from there. You may purchase reagents and obtain healing here. Speak to the Sisters of Virtue about Tibse. Ambrose (around midnight at the Healers) will speak to you of the Mystic Arms.

Hut in Desert

Talk to Sin'Vraal for the name of a Shadowlord.

Empath Abbey

There are three levels: the first has a Healer, the second a balcony with the Flame of Love. Toshi, a student will offer to join you. Talk to Tim. Converse with Lord Michael (and say **hsbqqmf**). Cory will give free food if you ask for **trvje** or **tibsl**. Julia offers

to join you. The third level is just a walk around the perimeter where you may find Tim at times.

Farthing

In Farthing you may learn a spell from Temme and get a spyglass from Lord Seggallion if you answer "Wjsuvf." Talk to Quintin.

Fogsbane

This is the lighthouse on the island just south of Britain. Jotham will speak of the Underworld.

Greyhaven

This lighthouse is on a peninsula south of Trinsic. Here you will find Sir Arbuthnot, the royal coin-maker. David the keeper will provide you with a **tfyubou** when you ask about it. Talk to Lord Kenneth, who will teach you to play the harpsichord. Be sure to search, for you will find five gems, 50 GP and a blue potion.

Hut on Island at NA LA

Just a small hut and a graveyard occupy this small island. At nine A.M., a young mage, Sutek, arises and reveals the secret of destroying the Shadowlords. Check out the small **hsbwfzbse** for messages.

Jhelom

There are two levels, the second consisting mainly of sleeping quarters. The first level has an Inn, a Tavern, an Armoury and a Shipwright. You may obtain a magic axe outside the walls to the east, but must first find the secret door in the northeast section on the main level. Talk to Thorne and the bewildered Mage who speaks and responds to "backward" words. (Ask for a "Word of Power" but spell it backwards—Drow of Rewop, then say "Dratsed." This is *not* coded with the QuestBusters Code.) Searching will net you food, torches and a scroll.

The Lycaenum

This Keep houses the Flame of Truth and has three levels. On the first level is a stable. She also tells how to find a Shrine. On the second level, talk to Mariah in the Healers' Room during the day. There is a Library and a Tavern. Talk to Lady Janell, Rollo and Lord Shalineth. The third level has a Healer and the Flame of Truth. Sir Sean will explain how to get to Stonegate, the fortress of the Shadowlords. Search for items.

Minoc

Some buildings on Minoc have second levels with sleeping quarters and items if you search for them. The ground level has a Healer (who does not charge for her services), a Shipwright and an Armoury. Follow Shenstone at noon. He leads you to a place where you can find keys. Rew reveals a Mantra and more useful info. Talk to Tactus, Fenelon and Fiona.

Moonglow

The town of Honesty has second levels where you can search for items, plus a telescope. The ground level has many items, an orb for viewing, and a shop selling reagents. You may also purchase rations here. Talk to the man in the tower. Malifora knows a Word of Power and a Mantra.

New Magencia

Ron Wartow has a Mantra. Katrina will offer to join you. Talk to Kaiko.

Paws

The gates to Paws is closed at night. You will find a Guild, Inn and Tavern. Glinkie tells how to find a Shrine. Talk to Bandaii (if you know where to find the talking horse). Stables hold a clue to the wishing wells.

Serpent's Hold

The gates open at five A.M. at this Bastion of Courage. Here you will find the Flame of Courage. An upper level has a large dining room. Kristi the cook will sell you five Skull Keys. Talk to Lord Malone, Monsieur Loubet and Gardner. Maxwell, a sleek Fighter, offers to join. A sub-level in Serpent's hold contains the Flame of Courage. If you fall down a trap door and appear to be closed in, search for secret doors.

Skara Brae

The town of Spirituality has a drawbridge that is raised at midnight. Here you will find an Inn, a Healer and a Shop selling reagents. Kindor reveals a Mantra. Talk to Saul about Mandrake and Nightshade. A wizard on the upper floor of the center building (after you defeat the bats) will answer to the word "pqqsfttjpo." If you provide him with a name he will send you to Windmere to see Elistaria and give you the password. Find and talk to the child in town, son of a prisoner in Yew.

Stonegate

See paragraph on the Shadowlords and the Sceptre.

Stormcrow

A lighthouse located southwest of Minoc, this has three levels and two inhabitants. Information is scarce, but try anyway.

Trinsic

On the upper level you will find sleepwalkers. Sindar gives a Word of Power. There is a Stable, a Healer and an Armoury.

Waveguide

A three-level lighthouse off the west coast of Verity Isle, this may not yield any information.

Windmere

Elistaria, in response to "Jnqfsb," gives you a badge that, if worn, helps you in Blackthorn's palace. She also says Thrud will provide you with jeweled weapons for the resistance password.

Yew

The town of Justice closes its gates at night. Search the cemetery graves for items. There is a Tavern, an Armoury and a Reagent shop on the ground level and quarters on the lower level. Janna will offer to join you. Ask Landon about the Crown. To reach the lower level, go through one of the fireplaces. Chamfort will tell you of resistance and a Mantra. If jailed, you will be taken to the cells behind Judge Dryden's office and should talk with Jerome. In another cell you will meet Felespar. Give him the password of the resistance, and he'll give you a Word of Power. Ask Judge Dryden of the pqqsfttjpo. Tell him Tactus of Minoc sent you. Tell Greymarch that Froed is well, and he tells of the Sceptre.

Vanquishing the Shadowlords

You may be able to defeat the Shadowlords in battle, but they will return unless you get rid of them permanently. To accomplish this you must first learn their names, obtain the Shards of Cowardice, Falsehood and Hatred from the Underworld, and finally destroy them at the Flames of Courage, Truth and Love. At the flames you must zfmm uifjs obnft and, when they stand in the flames, use the Shards to destroy them. The Lords of the three locations of the Flames will reveal to you the names of the Shadowlords. Use each Shard in the Flame of the opposite alignment. The Shadowlord must be standing on or in the Flame, positioned so he's due north of your character and his icon is covering the Flame's icon.

The Sceptre

Do not attempt to acquire the Sceptre until you have eliminated the Shadowlords. Stonegate, the Shadowlords' fortress, is located at EK JE. Just north of the Sceptre is a trap door that leads to certain death; equip the Magic Carpet before entering. A leather-winged abomination guards the entrance. The answer to his riddle is "well" but even if you answer correctly, he will still attack you.

Obtaining the Shards

The Shards are located in the Underworld, which may be reached by dungeons. Be equipped with the Magic Carpet. The Shard of Hatred is reached by either dungeon Wrong or Covetous. Falsehood is reached from Deceit, and Cowardice from Hythloth. The In Por spell (Blink) and the Grapple are needed for this phase.

Shard of Hatred

To descend in Wrong: Yell the Word of Power at the entrance. At the exit, head south into room. Kill off monsters, then descend to level two via ladder in middle of the room. Move six south, then five west to ladder down. (Watch out for the pit trap and force field.) Descend to level four, then go six south and take ladder down to level five, where you may heal at a fountain by going through a secret door north of you, then go west one and north two. The other fountain, two spaces east, is poisonous. From where you entered level five, head south two then follow along either east or west until you reach a chance to go down, making sure to destroy electric fields in your way (use An Grav spell or the Sceptre), then descend to level six. Wear the Crown (to ward off Wisps as you enter level eight). On level six move east (or west) two, then north two and descend to level eight. On level eight move north two, east one, then face north to reveal secret door. Go through the secret door and west three spaces to a healing fountain. Going east all the way, then south all the way will bring you to the exit to the Underworld. Be prepared for battles, electric fields and bomb traps.

In the Underworld: Go south on the path to the fork, then go east on it for a short while before heading south again. At the next fork, move south. At the next fork, go west and look for a gap in the High Mountains to your east. Find it and begin climbing east, following the path of low mountains between the High peaks. View a gem and you'll see a glen in the middle of some mountains; this is the Shard. Keep climbing until you reach it.

Shard of Falsehood

To descend in Deceit: At entrance yell Word of Power. From the exit of the dungeon, go north through a secret door to the ladder down, then descend to find a healing fountain (you'll need it after battling the Daemons on the next level). Go due south down a hallway and take the ladder down to level three. You're now in a room filled with Daemons, where a force field blocks the middle of the room (dispell it). Take the ladder down at the other end of

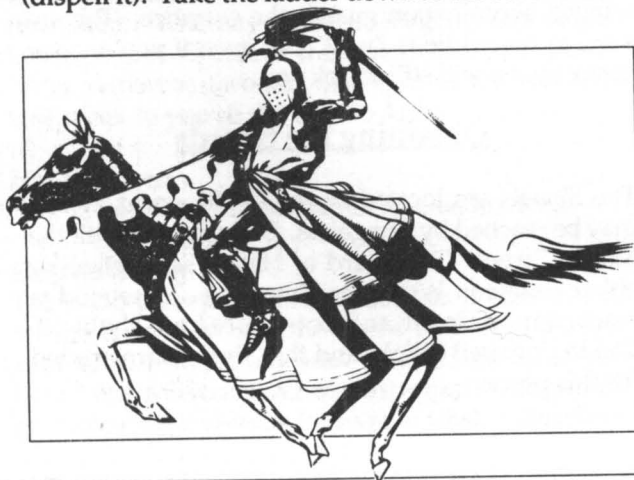

the room to level four. Climb down again to level five. Go three west from the ladder, then due south and take the ladder down to level six. Go one west and search for the pit trap (in the middle of an intersection). Find it, step on the spot where it is and go north to take the ladder down to level seven. Go west into the room and exit it north. Go north to the wall, one east, north two to ladder down to level eight. Go four south from ladder to intersection, move two east, then face south. Go south through two rooms (behind some pillars in here are some dragons, which can be killed—but you can't get their treasure; also watch for a trip that releases some monsters). Then enter the next room south to the room with five black squares in a wall (in the middle of room) and a ladder down on the other side. Take a torch in the upper right-hand corner, walk into the space formerly occupied by the torch and push on the east wall there. (On the way out, however, push the west wall in the lower left-hand corner.) This allows you to access the first block, where you'll defeat a monster. Push on the west wall there to open a block to the east. Defeat the monster, enter the block he occupied and push the east wall. That opens a wall to your west, where you enter another block with a monster. Kill him, enter his space and push the west wall. That exposes the block furthest to the east and releases the dragon. (Try to use Morningstars or spells on him before you release him.) Go all the way down to the space he occupied and push the east wall. That releases the other dragon. Kill him, then go one east from the space he occupied and push the south wall to open a wall so you can access the ladder down on the other side (but on the way out, push north, not south). Take the ladder to the Underworld. (On the way back out, push on the west wall in the lower left-hand corner to open the wall. Then follow the above directions, except in the above noted exceptions.)

In the Underworld: You begin at (5) on the provided map). Go southwest over lots of mountaintops until you reach some large caves. Then head southwest to a major intersection, where you turn northwest and go northeast at the branch. Go north a long way, till the path switches west, through some rocky hills to the southwest and finally you will come to a lake. Look for the river that flows south. Jump on the Carpet and take a ride down the rapids to find the Shard on a small island.

Shard of Cowardice

To descend in Hythloth: From the exit, descend to level seven. On level seven move south two (through secret door), west one and up to level six. On level six move west two and down to level seven. On level seven move south two, east one, south two, then east (through secret door) four. On level eight move west three to Underworld exit. (Mystic Arms are found near the Underworld exit to Hythloth.)

In the Underworld: Carry lots of gems. Go to clearing due south (as far as you can go on foot). "Blink" into the clearing to the west, then go northwest as far as you can walk and view a gem. "Blink" into the clearing to the north. Then go north and "Blink" over more mountains. Move west and "Blink" across more mountains. Go north and "Blink" again. Head northwest to the clearing, where you'll find the Shard.

The Amulet

The Amulet is located in the Underworld (go through the dungeon Destard, then southwest, using Magic Carpet to avoid poisonous area), among the Graves of Valiant Warriors (near OE GJ). (See Underworld map.)

To Descend Dungeon Destard:

You don't *have* to enter through the dungeon; just follow the journal of Lord British's last trip in the manual. But you should exit through the dungeon by reversing these directions. Yell the Word of Power. From level one head south two, east four, south two, east four, south two, then descend to level two. From level two move south two, east four, south two, east two, then descend (through level three) to level four. On level four move north two into a room and fight off the monsters. Then take grate down to level five. On level five move south two, east two, then descend to level seven. On level seven head north one, east one into a room and exit north two, west one, north two into a room, then descend through grate to level eight (after battle). On level eight you may Des Por to the Underworld or travel to the exit. Either way, you will have to fight your way through two rooms when you reenter the dungeon. The exit to the Underworld (from the ladder) is south six, west two, south two, west two, and south three to a room entrance and enter. (Demons and Wisps are in here.) When exiting from this room, take north, east or west exit if going to the surface. If headed for the Underworld, go south, use any weapon and hit torch in the middle to open the south exit and turn that half of room into a lava field. (You'll need a high-level party to survive this and the next room; then exit south, and move one south to the ladder to the Underworld.

Dungeon Doom: The Final Quest

Here you will finally meet and rescue Lord British. The dungeon is located at the exact center of the Underworld and is reached by descending through dungeon Shame. Use the Amulet to get through the dark area to Doom. You must have the Dspxo, Tdfqusf, Bnvmfu and Word of Power for Doom. You also need the Tboebmxppe Cpy.

To Descend Dungeon Shame:

Yell the Word of Power. At first you appear to be locked in, but by attacking rocks on the southern edge

of the level with magic axes, you'll eventually reveal a southern exit. Go through the exit and take the first corridor on your left. Follow it around to the descent to level seven. A sign will inform you that this is the "deepest" level. On level seven go south four, then descend to level eight. On level eight go west one then Des Por to the Underworld. The exit, if you care to find it, is (from your entrance on level eight) west two, south one, west one, south two, then east (through secret door) three. To find Doom, travel east as far as you can go, then "Blink" to the grassy plain. Cross the water on the Magic Carpet.

You must have already killed all the Shadowlords before entering Doom. Also required are the Crown, Sceptre and Tboebmxppe Cpy. Up and Down spells cannot be cast here, so you can only exit by saving Lord British or by being killed. Rings of Invisibility don't work well here. It helps to xfbu uif Dspxo.

Dungeon Doom

Level One

Exit the room at (a) by walking up to the edge of the west wall and using the Sceptre, which clears out the walls. Follow the hall to the ladder down at (b).

Level Two

From (c), walk to (d) and take the ladder down.

Level Three

From (e), go due east through the secret door and east to the room at (f), where you can go down.

Level Four

You emerge from Level Three at (g), but continue down the ladder to Level Five.

Levels Five and Four

You emerge at (h) and go east, then climb up the pit at (i). You'll be at the top of the plus sign-shaped area (j) on Level Four. Go south and search for the pit (k). Climb down the pit, and you'll be in the east/west corridor on Level Five. If you look at a gem, this area looks like a giant grid, with endless hallways in each direction. Right now you are in between intersections. (You're about to get bounced around between levels a few times here.) There are pits going up at intersection in this area. Go east to the first intersection, turn north and take the first pit that goes up between intersections (this is not shown on the maps). You should come out at (m) on Level Four. Search for the pit at (l) in the area's southwest corner, which takes you to a ladder that goes down through Level Five and drops you off at (n) on Level Six.

Level Six

Go west from (n) to the room at the junction, then move north to the ladder and go down.

Level Seven

From (o), go north to the room in the middle of the hall. Don't just pass through. You must slay all monsters in the room. A Fear spell—followed by a Tremor or something like that—does wonders here. Be sure to wear the Crown here. After wiping out the fiends, collect all their stuff. From a sandtrap in the center of the room, you'll find a chest. Open it, take out everything, and a ladder appears under the chest. Go down this ladder. (If you've taken extensive damage, leave the room and heal first.)

Level Eight

You emerge in a room (p) divided by a river. Kill off the Dragons and Sea Serpents (a Fear spell works well here too). To cross the river, you must activate a trip mechanism in the upper left corner of the room. Use a magic axe, spears or a throwing axe and hit the wall in that section. It's left of the two waterfalls. When you hit it, the bridge is lowered so you can cross the river. This also releases some monsters, but you can just race across the bridge if you don't want to fight it out. Go west and climb the ladder to (q) on Level Seven.

Level Seven

In the room at (q), you want to go south but there is no exit. So wipe out the monsters and push on the wall near the grate to activate the trip, which exposes a section of wall to the north. From where the grate is, go to the section of wall just revealed and push on it, which opens an exit to the south. After going south, search for a trap at the end of the hallway. This pit trap takes you down to (r) on Level Eight.

Level Eight

Go west from (r) and climb up the ladder to (s) on Level Seven.

Level Seven

From (s), go west and south, searching for the pit trap on the corner. Go around this one, search again and take the next pit trap (t) down to (u) on Level Eight. (Be sure you're wearing the Crown before going down the pit.)

Level Eight

On the island (u), first wipe out all the monsters. Choose one character to go to the northern section of the room, which appears to contain an exit. After the exit seals itself off, someone should push around on the little niche up in the walls of the room's northeast corner. There's a trip that opens an exit to the east. Go east to (v) and climb up the ladder to (w) on Level Seven.

Level Seven

In (w) is a giant brazier. Do not hit or push the brazier (unless you enjoy being engulfed in hot lava). To deal

with the Daemons on the other side of the barrier, use the Sceptre to chew it away. (If you're wearing the Crown, the Daemons can't harm you.) Then walk through and bash the monsters. (Or you can stand near the wall and attack them with a Morningstar, though this would take a long time.) Exit to the east, but search before you get to the end of the hallway to avoid falling into a trap. After searching, you can go down the pit to (x) on Level Eight.

Level Eight: Free at Last!

This room (x) has no exits. Walk up to the mirror. (Hopefully you brought the Tboebmxppe Cpy.)

Tables

Potential Party Members

Lord British's Castle	Saduj (don't let him join!)
Brittain	Guenno
Bordermarch	Dupre and Sentri
Buccaneer's Den	Geoffrey
Empath Abbey	Julia and Toshi
Lycaenum	Mariah
New Magencia	Katrina
Serpent's Hold	Maxwell
Yew	Jana
Ararat	Captain John

Dungeons

<u>Name</u>	<u>Location</u>	<u>Words of Power</u>
Covetous	BL JM	Bwjevt
Deceit	EJ PA	Gbmmy
Destard	KI EI	Jopqjb
Despise	ED FL	Wjmjt
Wrong	BE HO	Nbvmv
Hythloth	PA OP	Jhobwvt
Shame	GG DK	Jogbnb
Doom	HA HA*	Wfsbnpdps

The Shadowlords' Names

Falsehood	Gbvmmjofj
Cowardice	Optgfoups
Hatred	Btubspui

Location of Shards (in the Underworld)

Falsehood	FA MA
Cowardice	LA LI
Hatred	EB IC

Location of Flames

Truth	Lycaenum
Courage	Serpent's Hold
Love	Empath Abbey

Miscellaneous Items & Places

Spyglass	Farthing (Lord Segallion)
Badge	Windemere (Elistaria)
Jeweled Sword/Shield	Windemere (Thrud)
Magic Carpet	Lord British's chambers

Sin'Vraal's Hut	DA, MJ
Sandalwood Box	Lord British's chambers (behind secret door, after playing harpsichord)
Talking horse	Iola's barn (NA LA)
HMS Cape plans	East Brittany
Stonegate	EK JE
Blackthorn's Castle	Isle of Avatar, southern tip
Harp lessons	Greyhaven (Lord Kenneth)
Crown	Lord British's castle, top level
Sutek	Marshe Island in middle of ocean
Grapple	Empath Abbey (Lord Michael)
Sextant	Greyhaven (David)
Sceptre	Stonegate
Skull Keys	Serpent's Hold (Kristi), Minoc (canget five a day from northwest tree)
Nightshade	JF CO (Midnight only)
Mandrake Root	DG LG (Midnight only)
Glass Sword	FA EA
Amulet	OE GD (Underworld)
Mystic Arms	OL NF (Underworld: from Hythloth, in lava north across peaks)
Ararat (ark) *	CJ CC (Underworld)

for the Dungeon Doom). The waterfall at IK DG will take you to Underworld if you are on Magic Carpet.

Shrine	Location	Mantra
Honesty	EC OJ	bin
Compassion	FM IA	nv
Valor	OF CE	sb
Justice	AL EJ	cfi
Sacrifice	CN MN	cbi
Honor	MP FB	tvnn
Spirituality	BD KF	pn
Humility	NI OH	mvn

Effects of Potions

Yellow	Heal
Green	Poison yourself (Immunity to Death, but rarely works)
Orange	Sleep yourself
White	X-ray vision
Black	Invisibility
Blue	Awaken yourself
Purple	Turns you into a rat
Red	Cures poison

Spells

In Xen Mani	Creates food
Rel Xen Bet	Change into a rat
An Ylem	Vanish

*Ararat is the only place in the Underworld that has an occupant. The person there will join you and is useful because he casts fairly high level spells.

Passwords

Resistance	Ebxo
Oppression	Jnqfsb

Shrines

You must visit a Shrine, then the Codex, then the Shrine again, in order to be rewarded with an increase in attributes. After visiting all Shrines, you will be given an important clue (the word of power

Moongates

When a Moongate disappears, you can search and find a Moonstone. These may be carried, and when used at any (grassy) location, will establish that Moongate at that spot. It is advisable to take one or more of the moonstones from gates that are not absolutely necessary, because you can travel to the location by other means. For instance, it would not be wise to remove the Moonstone from New Magencia; good candidates are the stones near Brittany Bay, Yew or Trinsic, because these locations are easy to get to by Magic Carpet. (These are not coded.)

Moongate Locations

<u>Gate</u>	<u>Vicinity</u>	<u>Activation</u>	<u>Lat./Long.</u>	<u>1st</u>	<u>2nd</u>	<u>3rd</u>
1	Moonglow	New Moon	IF OA	1	2	3
2	Britain	Crescent Waxing	GG GA	4	5	6
3	Jhelom	1st Quarter	OA CG	7	8	1
4	Yew	Gibbous Waxing	CF DC	2	3	4
5	Minoc	Full Moon	BD KG	shrine	6	7
6	Trinsic	Gibbous Waning	MC GI	8	1	2
7	Skara Brae	Last Quarter	HO BH	3	4	5
8	New Magencia	Crescent Waning	KH LL	6	7	8

Map Key: Ultima V

The Underworld

- 1 : Destard
- 2 : Hythloth
- 3 : Wrong
- 4 : Covetous
- 5 : Deceit
- 6 : Despise
- 7 : Shame
- 8 : Amulet

- 9 : Waterfall from Upper World
- 10: Ararat
- 11: Dark Area
- 12: Shard of Hatred
- 13: Shard of Falsehood
- 14: Shard of Cowardice
- 15: Mystic Arms
- 16: Poison Area

Dungeon Doom

- D: Ladder down
- U: Ladder up
- S: Ladder up/down
- R: Room
- T: Trap
- Solid triangles: pit traps (up/down)
- a-x: Route through Doom (see solution)

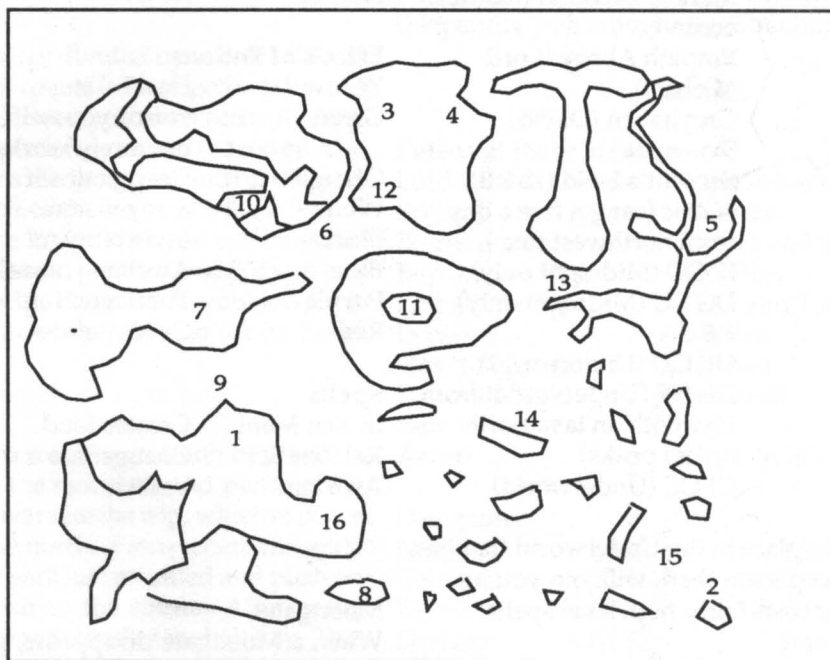

The Underworld

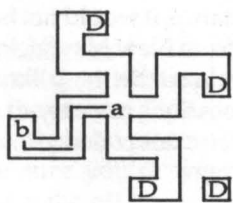

Level One

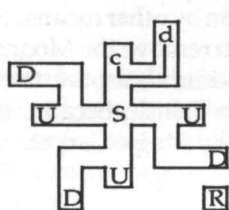

Level Two

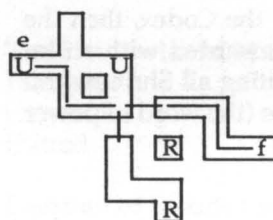

Level Three

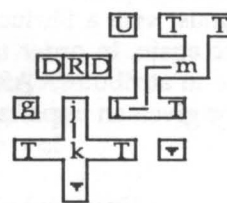

Level Four



Level Five

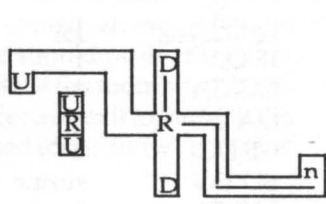

Level Six

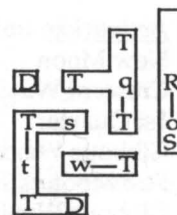

Level Seven

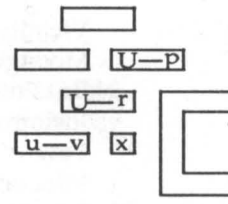

Level Eight

Dungeon Doom

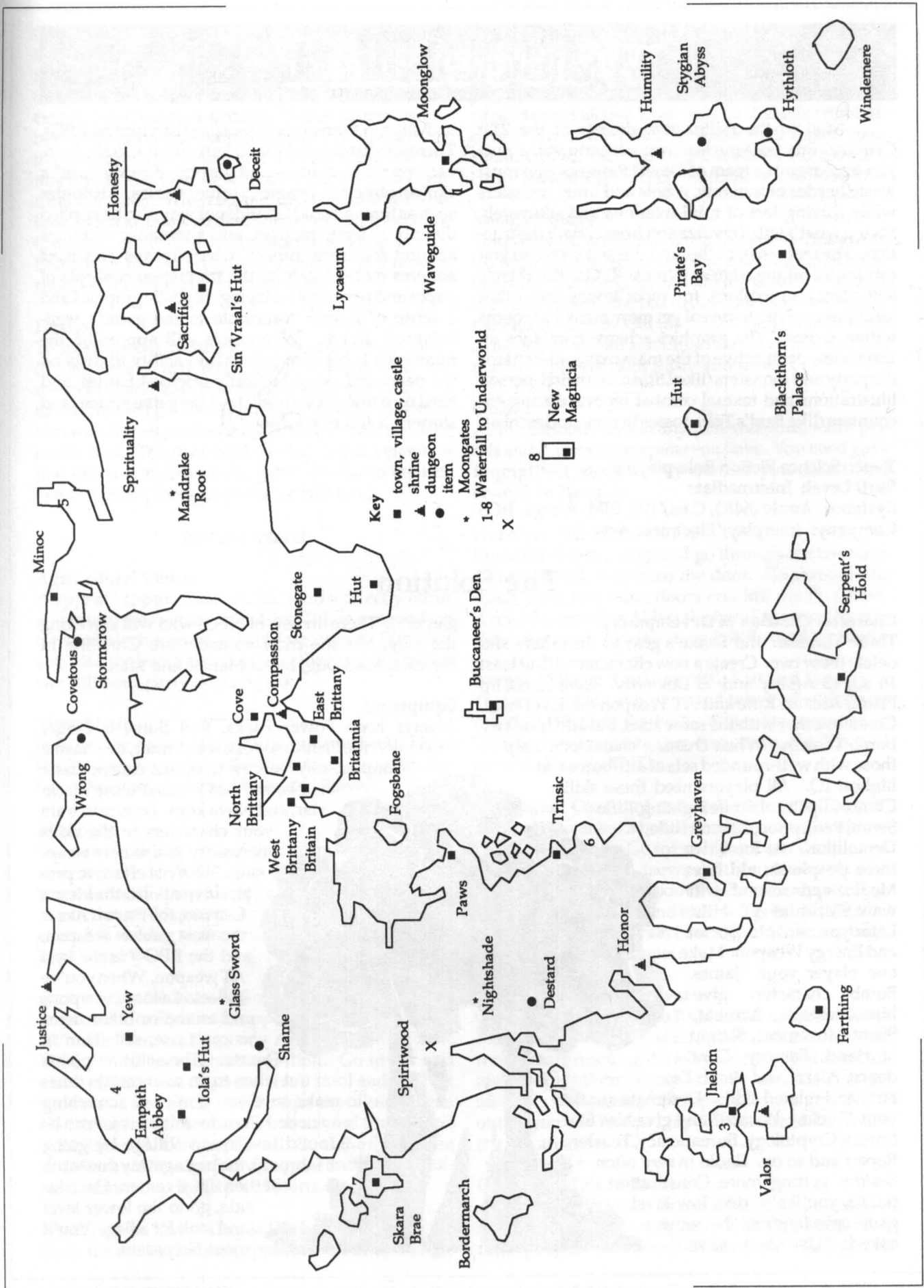

- Key**
- town, village, castle
 - ▲ shrine
 - dungeon
 - item
 - * Moongates
 - 1-8 Waterfall to Underworld

Wasteland

Set in the radioactive deserts of the 21st Century, this post-nuclear war scenario story puts you in charge of a team of Desert Rangers who must waste hordes of mutants, robots and other monsters while solving lots of mini-missions and ultimately saving what's left of civilization from certain destruction. The main map of the land doesn't scroll, so you can't walk off the edge as in most RPGs. But there's still plenty to explore, for most towns and other locations open up to reveal yet more areas and rooms within rooms. The graphics scheme combines an aerial view perspective of the main map and icons for the party and monsters (like *Ultima*) with first-person illustrations and textual combat reports during encounters (like *Bard's Tale*), tosses in non-stop combat,

and slips in more logical puzzles than typical RPGs. There are dozens of skills—Demolition, Climb, Acrobat, special weapons—and you can directly “use” a skill on objects or people to solve puzzles. Attributes such as Strength and Confidence may also be applied directly to some puzzles, and alternative solutions abound for many others, which means *Wasteland* adheres more closely to the traditional concepts of paper and pencil role-playing. Stylistic graphics and a sense of humor contribute to the game's well-balanced design. Wargamers will appreciate the numerous types of weapons and ability to disband the party and wage tactically oriented battles, and hard core role-players will find the game system and story rich and rewarding.

Type: Science Fiction Role-playing

Skill Level: Intermediate

Systems: Apple (64K), C 64/128, IBM, Amiga, IIGS

Company: Interplay/Electronic Arts

The Solution

Character Creation & Development

Trade Thrasher and Snake's gear to the others and delete these two. Create a new character with at least 16 IQ, 13 Agility and 13 Dexterity. Give him Clip Pistol, Assault Rifle and AT Weapon (all level two). Create another with the same stats, but add level two Bomb Disarm. When creating characters, keep those with well-rounded sets of attributes and highest IQ. All players need these skills: Climb, Clip Pistol, Knife Fighting, Rifle. Swim, Perception, Assault Rifle, Demolition. At least two to three people should have Medic, and several will want SMG and AT skills. Later you can add Doctor and Energy Weapon. Make one player your “James Bomb” character: give him Picklock, Acrobat, Silent Movement, Sleight of Hand, Forgery, Confidence, Alarm and Bomb Disarm, and related skills. Designate another your “Techno-Wizard” and give him Electronics, Cryptology, Bureaucracy, Toaster Repair and so on. Radio in *very* often. Besides getting more Constitution points, you'll also do a low-level game save (answer “N” when asked “Use last saved

game?”). There are lots of NPCs who will join along the way, but the most valuable are Christina in Needles, Mad Dog, Metal Maniac and Max.

Equipment

Always keep Power Packs, Rad Suits, a Geiger Counter, the Proton Axe, Power Armor, the Plasma Coupler, any energy weapons except Laser Pistols, and the Quasar, Pulsar, Blackstar, and Nova keys. Be sure to train your characters in the skills necessary to use new weapons. The most effective projectile weapon is the Meson Cannon, the Proton Axe is the best melee weapon, and the RPG-7 is the best AT weapon. When you've collected a lot of weapons and ammo or other items you can't use, sell them in Quartz. (The solution points out when to do so at certain times to make sure you don't sell something you need.) Pseudo-chitin armor can be found in Darwin Village by going through the passageway due south of the village center. Once inside, go to the lower level and look for a bag. You'll need Secpases.

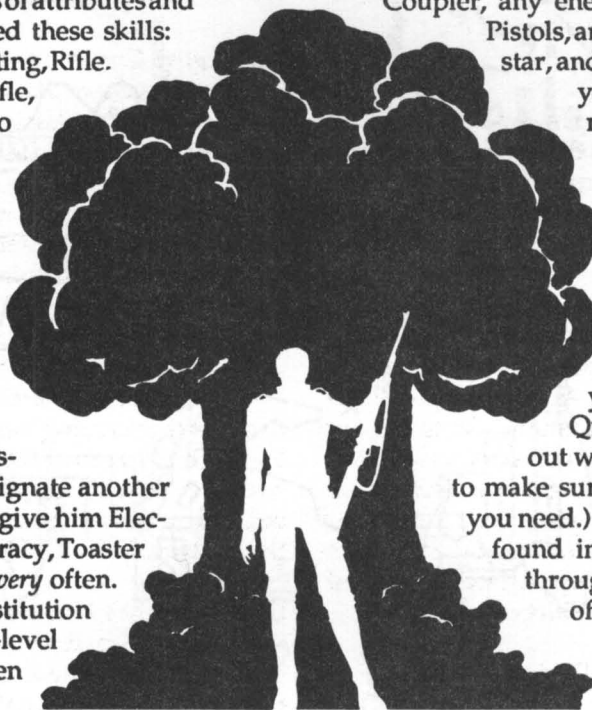

Combat

Energy weapons should be used only at these locations: Darwin Village's New Earth area, Las Vegas (especially the sewers), Base Cochise and, to a certain extent, the Guardian Citadel. Some situations are best handled by disbanding the party completely, or into several smaller teams. Don't rock and roll too much with any kind of weapons, since ammo of all sorts is limited. When hiring NPCs be careful about how much ammo you give them. Many, especially Christina, are trigger-happy and will waste ammo. Remember the Desert Ranger's motto, "If it moves, shoot it. If it won't open, blow it up."

Healing

To speed up the healing process, leave one character (strong enough to defend himself) outside while the rest of the party goes into a building. When you need to heal the party, view the outside character and have him wait (times passes faster outside) while the ones inside heal. The drawback on the Apple version is that this will auto-save the game when you answer "yes." (Other versions probably will too.)

Into the Desert

Agricultural Center

Bwpje uif cppui. Picklock the rooms directly north and south, then get the valuables. This is a good place for starting characters to build up points. (You can also visit the booth and check out the Root Cellar, but wait till your party is stronger.)

Mine Shaft

Picklock the room to the **sjhiu pg uif fousbodf**. Fight the Scavengers and get the Pick Axe. Use it on the box. Distribute the Gas Masks and leave.

Highpool

Go to the building west of the Infirmary and get the stuff on the bed. Sell it all at the PX (but they won't buy weapons). Keep **uisff spqft**. You can also see the boy in the southwest corner and get directions to the cave. Kill the dog and rescue the girl, but don't let her join the party.

Quartz: The Waitress at Scott's Bar

Buy drinks for Riddler in upper left of bar. Answers: "R" for Australia and America questions, VSBCVUMO for waitress question. Go to bar and disband, have one character sit on stool and wait for waitress. Say VSBCVUMO to get key. Join others. Go to Stagecoach Inn on Greybear and Target and enter Room 18. Use key. Get all. Go to the Emporium and **tfmm uif Nbohmfst**, extra guns and any agricultural items. Buy Bulletproof Shirts.

Needles: The Ruby Ring & Christina

Go to the Ammo Bunker, approach the body and get

the Ruby Ring. **Tbwf hbnf**. Use Perception skill on the explosives in the third alcove from the left. If you get that far, use **Cpnc Ejtbsn**. If they explode, restore your game. Get a TNT or Plastique, all the 7.62 mm clips (second alcove from left), and shells (right alcove.) Go to the Library. Have Hell Razor learn Assault Rifle, then go to Downtown #2, between Leroy's and the private club, and have Christina join.

Savage Village

The password is **Sfeibxl**. Drop weapons when asked. Go to northwest corner of Village and Picklock north building. Get the guns and kill the guards. Picklock the building with the box in it. Picklock the box or use the Pick Axe on it. Get the Mac 17 and ammo. Walk along the west wall and **cfuxffo uif uxp ivut** you just raided. TNT the door away and leave.

Quartz

At the Emporium, sell any non-weapons, extra pistols and primitive weapons you have. You need **gpvs fyqmpjtjwft** soon, so buy more if you didn't find enough in Needles.

Needles: The Waste Dump

Enter the Waste Dump and go through the left stairs and right hall, then blast the door. Go through the stairs, blast two more doors and kill the Pit Ghoul. Avoid the barrel and blast the **tpvui epps** on the **xftu tjef** of the room. Get the Assault Rifles and Rad Suits.

Savage Village: Loot and Kill, Kill and Loot

This time just kill everyone and take everything you can find. Breach the barn. Sell extra weapons in Quartz, but keep at least two extra NATOs and armors. Buy six TNT.

Las Vegas: Covenant and the Mushroom Temple

Picklock Covenant's bonds and hire him. Give him a NATO and armor. Go to the Mushroom Temple and say OSD to get in (several other passwords also work). When asked about a gift, say **cmppetubgg**. Go to the Doctor at (1) and hire him; give him a NATO and armor. Blast doors at (2) and (3) on this map to get more guns and Rad suits.

Quartz: Rescue the Mayor

Go to the **Dpvsuipvtf po Rvbjm** and use grenades or Manglers to breach steel doors. Free Citrine on level three before rescuing the Mayor (under bed in cell on level two). From Huey, Lewey and Dewey, get numbers from **ubuu ppt** to open safe in Ugly's Hideout. If you run low on hit points in this battle, rest in the cell area.

Quartz: Ugly's Hideout

Anyone with less than five AC should stay outside of town. Equip the best fighters with Rad suits. You need people with Bomb Disarm and Demolitions

Expert skills, plus one rope. Enter Ugly's Hideout and walk to the room's southwest corner. (The password is Lbqv.) Use rope south. Walk to southernmost part of the glass wall and blast the wall at that point. Kill the Pistoleros, making your way toward the south room. Kill the guard and Picklock the door. Walk onto the space between the wall and the south end of the table. If you don't see the safe, walk off, then return. Say **fmfwfo-tjyuffo-uxfouz tfwfo** (these are coded, but should be typed in as numbers, not words) Get the contents of the safe and save the game. Walk through the east door. Don't let Ugly leave. Kill him and his guards. Go to Felicia. Use Bomb Disarm on her. If the yellow light goes off, do it again. The red light should stop. (If any of the lights are still on, restore and try again.) Get everything there. Leave Felicia alone. Blast the door on her left. Get all. **Cbdlusbd1** to the **ibmmxbz** where you **foufsfe**. Go to the small hallway on the right. Enter north door of this hallway and kill all the Pistoleros. Picklock all three lockers, getting only two fruits and two chemicals (don't worry if there aren't two). Leave Ugly's through the door right of the kennels on the north side of the whole hideout. If you found only one chemical, go to the Inn and break into the House-keeping Closet in the Inn's northeast corner. Get the chemical and the Servomotor. Go to the Emporium and sell extra items, pistols and clips (except 7.62 mms).

Needles: The Holy Grid & the True Bloodstaff

Leave Doc and anyone under four AC outside town. You need a Demolitions expert in the main group, plus the gas masks. Enter the Temple of Blood and go through room with all the people in it, just to the left. Go through the hall until you come between two doors. Enter and get the Armors. Go west to the square that teleports you onto the Grid. Follow the map and say **uijsuz** (typed in as a number, not a word) to robot.

Below the Temple

Equip masks to characters with low Constitution and go north until you hit the island. Re-equip weapons. View. Have the outside party wait and View (but not saying "Yes") to check periodically on the main party. When they're healed, View and have them walk around the island, killing the two Snipers as they go. Blow the gate off the north part of the island and jump across the plate. Make your way toward the south edge of the inner building. Blast the door and kill everyone. Get the Bloodstaff (*never* pick up another Bloodstaff after this, or things might get confusing). Take all the LAWS first, Rifles second, then shells, then clips. Return for the Power packs later. Cross the Blood River and go south. Go east through the missile and say **npuf1jn** to the man. Leave by going through the force field to the northeast. Give Doc an Assault Rifle and go to the Mushroom Church.

Bqqspbd1 Cjtipq. Use Ruby Ring. Use Bloodstaff. Get things from Bishop. Go to Quartz and sell the Rifles, shells, clips and the engine.

Las Vegas: The Password at the Altar

Leave Doc outside town. The party needs a Demolitions expert and two TNT. Go to the Mushroom Temple and blast door (4). Walk along the wall, avoiding the core. Blast door (5) and walk to the altar (C). Reply: Yes. Reply: **Gbsbo cszhp**. Record the password. Leave temple. Kill Gundroids at (A) on main map of Vegas. Get the items. Kill Cyborg Commandos at (B) and get the items. View. Heal. View. Leave the Temple and walk around town, searching and killing enemies that have LAWS and RPGs. (Never sell these.) Avoid the Scorptron.

Needles and the Bishop

Go to the Mushroom Church and tell the password (from Charmaine) to the Bishop. Get the Bloodstaff.

Las Vegas and Charmaine

Enter the Mushroom Church and use the Bloodstaff in front of Charmaine.

Darwin: Mad Dog and Metal Maniac

Leave Doc outside and go to the Lab. Go to the table in the next room and use a **difnjdbm** on the table. Use a **gsvju** on the table. Get the antitoxin and repeat to make another one. Go to the Tavern and trade Angela Deth's and Hell Razor's gear to someone. Make sure they have nothing left. Send them out, have them get seriously wounded in combat, then have the main party get them back. Wait **voujm uifz ejf**, then bury them (this isn't necessary, but is a nice touch). Use the antitoxins on the two guys in the Tavern. Hire both. Give Angela's gear to Mad Dog, Razor's to Metal Maniac. Go to the Library and have Mad Dog learn Demolitions; Metal Maniac should study Assault rifle.

Guardian Citadel

Save frequently in this phase, and a back-up copy of this disk is a good idea. Leave Doc outside and equip your best AT weapon guys with LAWS and RPGs. You'll need Mad Dog, Metal Maniac, Covenant (or someone with equivalent Strength) and one TNT. Enter the Citadel. Staying **ofbs uif fyju**, align with the middle flag. Walk up to (1) and kill them. If seriously wounded, heal by Viewing Doc. If not, equip more AT weapons. Get the Pulsar key. Walk to (2) and blast the wall south of you. Walk in the hallway and Picklock the door. Make sure you're healed. Walk to the opening on your left. If down to half your Constitution, **svo mfgu ps sjhiu**. Heal with Doc. Reequip AT weapons and attack again. Keep doing this until you win. Walk to (3) and use Safe-crack on door. When you get the things inside, make sure you leave one Power Pack there. (Otherwise the

room will explode.) Heal up and equip RPGs to back up the Meson Cannon (4) (you must practice with it first). Walk north through the opening and kill the woman *immediately*. Send one person through the left opening, then bring in the others and kill Austin. Get the Ion Beamer at (5) and heal up. Walk to where you entered, then walk to the right hall. Go through the right opening that leads you to (A). Avoid Kenneth for now and go north to (6). Kill the three Sisters. Walk east, then north toward (7). Kill the Cook. Walk to (8), then through the door on your north. Walk through the hall where you see (10). First you'll see three distant attackers. Coax them into coming closer, while running to (9). When they're at *tjyuz gffu*, attack. Walk to (10), kill the girl, then walk along wall (see path on map) and across stairs to (11). Go through door to (12) and kill the three guys. If at any time Covenant is seriously wounded or the others go critical or worse, restore. Have Covenant use Strength at (13) toward the portcullis lever. Go up the stairs at (14) to the Inner Sanctum. Go to the computer next to the door. Say *Sptfcve*. Go in the room (15) and get the Power Armor and other gear. Go down the stairs and leave the Citadel the way you came in.

Las Vegas: The Scorpitron & the Sewers

Leave Doc and anyone with less than 14 AC outside. You need a Sonic Key. Kill the Scorpitron at (C). The trick is to disband and catch it in crossfire with LAWS and RPGs. Then walk through the city and kill any Warriods that appear. If anyone has 23 IQ and three skill points to spare, go to the Library and learn Energy Weapon. Arm these people with the Meson Cannon, Ion Beamer and Laser Rifles. You'll also need a TNT, Demolition expert and either Pickaxes or someone with at least 20 Strength. Go to the Mushroom Temple and *cmbtu epps* (6). Go through the southwest door to the hall, then through the hall until you reach a door with an "x" on it. Use the Sonic Key on the door, then exit through the "This Way Out" door. Go to (1) on the Sewers map. Get Servomotor. At (2), *ljmm uif spcpu* and get the Power Converter. Use rope (south) at (A). At (3), wipe out the 'bots and get the Fusion Cell. After going past (C), destroy more of them and get the items and the Rom Board at (4). At (B), use the rope (hit space bar for direction). At (5), wipe 'em out and get the Servomotor. Walk to the "\$" wall in the room to the south. Use Strength (must be at least 20) on that wall until you get through. (Pickaxes will also work.) Go until you reach the exit (right arrow on map). Go to the north exit (north arrow). Go to the room with all the "\$" walls. Use Strength on them. At (6), defeat the fiends and get Max's head. Go back through the passage you made. At (7), whomp on the steelheads and get the Servomotor. Go through the south exit (down arrow) and at (8), win again and get the ROM Board. At (9) you'll be rewarded with a Servomotor. Go to the Lab, the room marked with A, B, C, D and 10. Use the

Sonic Key on the Lab door. Kill the Hexborg at (10) and get the Rom Board.

The Lab: Fixing Max

At D : Press 1 and 2, use Servomotor, press 1 & 2, use Servomotor, press 3.
At C : Press 1 & 2, use Servomotor, press 3.
At B : Press 1 & 2, use Fusion Cell, press 1 & 2, use Power Converter. Press 1 & 2, use Servomotor, press 1 & 2, use Rom Board, press 3.
At A : Press 1 & 2, use Android Head, press 1 & 2, use Rom Board, press 3. Exit through the force field to the south. If possible, learn Energy Weapon at the Library.

Guardian Citadel: Looting the Place

Leave Doc and anyone with less than 14 AC outside. At (A), Picklock the case and get the Quasar Key. At (B) in the Outer Sanctum (purple walls), save after killing the enemy. Use Bomb Disarm on him. (Restore if you die.) Get the ring and Plastique. At (C), use Perception on the triptych and get the Blackstar Key. At (D), kill Jethro and get the Proton Axe. Kill the Cardinal at (E) and get his goods. Annihilate the "Sleeping Monk" at (F) and get the Nova Key. After entering (G), open up the *uisff eppst* and get the goods. Get the Energy Weapons at (H) and give somebody Clone Tech. In the Inner Sanctum (upstairs), use Perception on the tables and get the SecPass B at (I).

Sleeper Base: Send in the Clones

This is in the northeast corner of the map, but you can't find it until Max is activated. If the SecPass doesn't work at all places, don't worry, for you'll find more. Get SecPass 1 at (A) by using Strength on door. Secpass 3 is at (B). Go down to Level Two and get SecPass A at (C). Go to Level Three, then to (D) and Picklock the desk to get Secpass 7 and a Power Converter. Open up all the doors in the base. Go to (E) on Level Two and use TNT or Plastique on one of the crystal walls to get Pseudo-Chitin Armor, Meson Cannon and other items. At (F), get one jug and other gear. At (G), use the *Qpxfs dpowfsufs* on the Controller. Go to Level Three and turn the power on at (H). Return to Level Two. To make a clone: press 1 at (I). Use Clone Tech. Press 2. Press 3. Use jug. Press 3. Get fluid. Go to (J). Disband one person with the *gmvj* to walk into a pod. Get the jug. Make three more clones, preferably of different characters, the same way. If one of the cloned people dies later, go to the adjacent terminal and Release him. If you want to clone someone else but the pod is occupied, Abort the clone.

Base Cochise: Max meets VAX

You need RAD suits to reach Cochise through a trail north, then west of Vegas. Leave Doc and a character with less than 10 AC outside. Fight your way north

to the gate. Picklock and use SecPasses on the gates. Enter. Take sjhiu escalator (A) up, then go north. At the terminal (B), say csfb1. Picklock out of the cell and go down the hall, not opening any doors until you reach the room with computers. Go to the computer on the far right, nearest the west exit. At the terminal (C), say svo. Pick "C" and View the outside party. Trade the second guy's gear to Doc and send him out to be killed; bury him. View. Go to robot (D) and hire him. Save the game. Go through the west hall. Send Covenant, VAX, Christina and Metal Maniac across the waste to fight the Xenon Cannons. If anyone goes Serious, restore immediately. Go to the terminal (E) and Extend the bridge. Bring the others across. Go north, then west and use Picklock or SecPass to enter the room. Walk onto the tusbohfvqsqmf gjfme (F) on the left, then walk south. Go to Vegas Hospital and cure the Radiation Poisoning.

Base Cochise: Showdown at the Robot Corral

Leave Doc outside. Carry the Pulsar, Quasar, Nova and Blackstar Keys, four Rad suits and six TNT. On level three, go to the terminal and enter tunnel, then to the last room in the hall (the one with all the loot). If heavily wounded, retreat to the hall until the Octotrons can't hit you, then heal and attack again. After killing all the Octotrons (there are some on the sides), get the loot. Go to the room with the purple field and go down the ladder. Send VAX to the room on the right. Have him walk to the terminal (A) and open vault door #1 (B). Rejoin the party and hp tpvui. Send someone with good Perception west; when he approaches a mine, it should appear so you can avoid it. Open vault door #2 (C). Rejoin and go south. Vanquish the Xenon Cannons (D) and send VAX east. He can just walk through and will seldom get hurt. Open vault door #3 (E). Rejoin and go south. Send your best fighters into the west room and walk along the south wall. Defeat the Xenons, then walk along the south wall and defeat the rest of the Xenons here. At the terminal to the north, open vault door #4 (F) and retrace your steps to exit. Rejoin and save the game. Go down the ladder and Picklock the door. On level four, kill the Particle Beams and follow the safe path on the map to the Robot Maintenance Room. Blow the door, then blow up the machinery at (I). Go to the Security Electronics Room and blow the door. Go to the OSHA Room and blow the door. Walk south to the robot. When uxp tqbdfv bxbz, Encounter. Kill the Octotron and anything else that gets in your way. Go to the Reactor Room.

Base Cochise: The Reactor Room

Blow the door and send in a Demolitions expert xfbvjoh b Sbe tvju. Have him blast the glass wall in the Reactor Room. Rejoin and rearmor him. Exit (the purple field takes you to the entrance) but not all the way into the desert. Outside the gates, go west and you'll see a battle-scarred wall. Ljmm uif spcpu on

the xftu tjef pg uijt xmmm and get the Plasma Coupler (there are two other ways to do so, but this is the easiest). Leave and get Doc; make sure he has Power Armor. Save the game. Return to the Reactor Room. Split the party into gpvs hspvqt of equal fighting ability; VAX alone should be one of the groups. Give each party a key (Pulsar, Quasar, Nova and Blackstar) and a Rad suit. Give VAX the Blackstar Key, Plasma Coupler and a Rad suit. VAX should use the Coupler on the machine formerly surrounded by glass in the Reactor Room. Send him into the corner room there (A). Have the party with the Quasar Key enter the OSHA Room's corner room (C). Send the Nova Key party into the corner room of the Robot Maintenance Room (B). Dispatch the Pulsar Key party to the corner room of the Security Electronics Room (D). Have VAX use the Blackstar Key on the cylinder. The Nova team should use that key on their cylinder. The Pulsar party should use that key on their cylinder. The Quasar party uses that key with their cylinder. (Save the game before proceeding.) Press the space bar and have VAX enter sfe; Pulsar, zfmmpx; Quasar, hsffo; Nova, cmvf. Send the Nova team to join the Pulsar team at (J) in the hall. VAX should join the Quasar team at (K) in the hall, then send VAX's team to join the others at the stairway entrance. (The entire party should be together now.) After the destruct sequence is activated, escape capsules appear above (H). Enter these and you'll wind up next to the computer on level one. Use Climb skills or blast a hole in the area, then exit and enter the desert. Get outta there before the whole thing explodes! Don't forget to Sbejp jo.

Other Puzzles

These are not necessary for solving the game, but may make it somewhat easier. They're also provided for people who finished the game and still want to know the answers.

The Hobo's Camp & Quartz

See the Brakeman for a mission. Then head for Quartz. Take the item from the Brakeman to Head Hunter, west of restrooms. Get password (dbufsqjmmbs). Enter men's room and defeat outlaws, get clues from body and boy. Check out all tables for clues. Go to Hobo's Camp and say password to guard at left tent. Follow instructions for treasure and tools, then return to Quartz. In the Cemetery, get the broken toaster.

Finster's Mind

Answers to riddles in Finster's Mind are: (1) uijsuz-uxp (type in the number, not the word) (2) gjwfivoesfe uxfmwf (3) uxfouz (4) Gjotufs (5) opuijoh (6) jdfcfsh. In the fourth arena you have to go to the northwest corner and use IQ to get through teleportation spaces. IQ is also used when you hear friends

talking about you. Use Secpass 7, the password Qspufvt and Strength to get inside. Liberate the prisoners and go upstairs to kill Finster and hook his head up to the Mindlink. (The character who attaches the head should have a powerful weapon, plus high stats for that weapon's skill, Luck, IQ and Strength. After answering the first three riddles in arenas one-three, use IQ in the fourth arena's northwest corner. Slay the spider and break the web with strength. Use Luck if tossed into the showers while playing baseball. Break through the wall with Strength in the seventh arena, kill two more Finsters and break through the wall again. (After the second Finster dies, get the jug if you need one.) Get the Android head after killing it. Immediately after entering the next room, race back to the previous room, touch the wall and run to the place where the voice warns your friends will be killed if you go east, and you'll be ljmmfe if you go xftu. Then take one step east and one south. Use IQ in the next room until the exit opens, then enter the final arena and slay Finster. Get Secpass B and jump into the pit.

Fixing the Jeep

Ace, in the basement in Quartz, can get the Jeep running, but it will only go to the garage in Needles. You'll need the other engine (one is sold in the Hobo Camp, another is awarded by the Mushroom Bishop in Needles when you return the Bloodstaff.)

The Broken Toaster

After learning the related skill, you can get a VISA card and Power pack from the toaster. Use skill at the Toaster Repair Station in the Citadel.

The Helicopter

This will take you to Base Cochise if you have the skill, which could save some time, since you could land on top of the building.

Map Key: Wasteland

Quartz

- | | |
|--------------------|------------------------------------|
| 1 : Emporium | 5 : Leroy's Arms Counter |
| 2 : Scott's Bar | 6 : Christina |
| 3 : Stagecoach Inn | 7 : Gas station |
| 4 : Ugly's Hideout | 8 : Temple of Blood |
| 5 : Courthouse | 9 : Waste dump |
| 6 : Cemetery | 10: Sand hills (practice climbing) |
| 7 : Dr. Quack | 11: Church of the Mushroom Cloud |

Needles

- | | |
|--------------------|---------------|
| 1 : Ammo dump | Las Vegas |
| 2 : Police station | 1 : Library |
| 3 : Library | 2 : Informant |
| 4 : Doctor | |

- 3 : Hospital
- 4 : Spade's Casino
- 5 : Fat Freddy's Casino
- 6 : Hospital
- 7 : Jail (Covenant)
- 8 : Temple of the Mushroom Cloud
- A: Gundroids
- B: Cyborg Commandos
- C: Scorpitron

Guardian Citadel

Map One

- 1 : Pulsar Key
- 2 : Blast hole in wall here
- 3 : Door (use Safecrack)
- 4 : Meson Beamer
- 5 : Ion Beamer
- 6 : Three Sisters
- 7 : Cook
- 8 : Door
- F : Flag
- A: Quasar Key

Outer Sanctum

- 9 : Corner
- 10: Girl
- 11: To exit
- 12: Three foes
- 13: Portcullis lever
- 14: To Inner Sanctum
- B: Ring & plastique
- C: Blackstar Key
- D: Proton Axe
- E: Cardinal
- F: Nova Key
- G: Miscellaneous gear
- H: Energy weapon

Inner Sanctum

- 15: Power Armor
- I : Secpass B

The Sewers

- 1 : Servomotor
- 2 : Power Converter
- 3 : Fusion Cell
- 4 : ROM board
- 5 : Servomotor
- 6 : Max's head
- 7 : Servomotor
- 8 : ROM board
- 9 : Servomotor
- 10: ROM board
- A-D: The Lab

Sleeper Base

- Level One
- A: Secpass 1

- B: Secpass 3
- L & C: Library & Clones

Level Two

- C: Secpass A
- E: Pseudo-chitin armor, Power packs, weapons
- F: Jug
- G: Controller
- I : Cone fluid
- J : Clone pods
- L : Library & Doctor

Level Three

- D: Secpass 7
- H: Power switch
- IF: Info files
- PC: Plasma Coupler
- HS: Helicopters simulator

Base Cochise

Level One

- A: Escalator
- B: Terminal (break)

Level Two

- C: Terminal (run)
- D: VAX
- E: Terminal (extend bridge)
- F: Purple field (exit)
- S: To Level Three

Level Three

- A: Terminals
- B: Vault door #1
- C: Vault door #2
- D: Xenon Laser Cannons
- E: Vault door #3
- F: Vault door #4

Level Four

- A: Blackstar
- B: Nova
- C: Quasar
- D: Pulsar
- E: Machine requiring high I. Q.
- F: Glass wall
- G: Fusion Octron
- H: Stairs
- I : Conveyor belt control
- J-K: Rendezvous points for party during end game

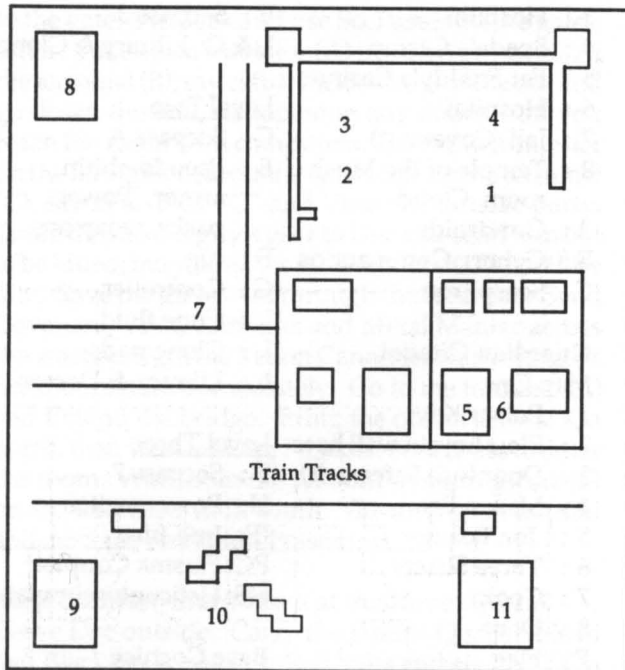

Needles

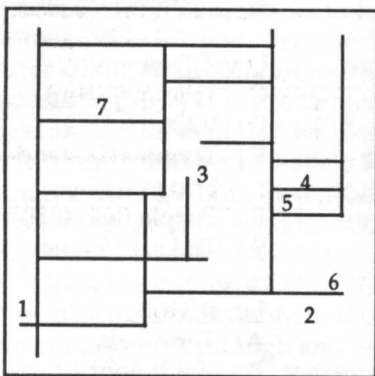

Quartz

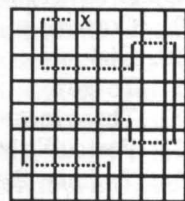

The Holy Grid

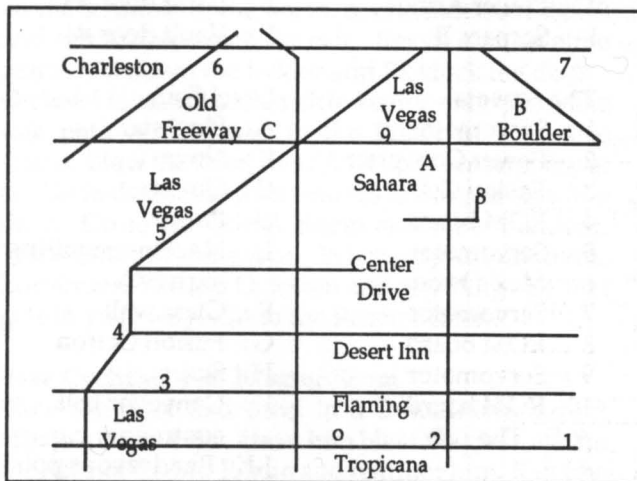

Las Vegas

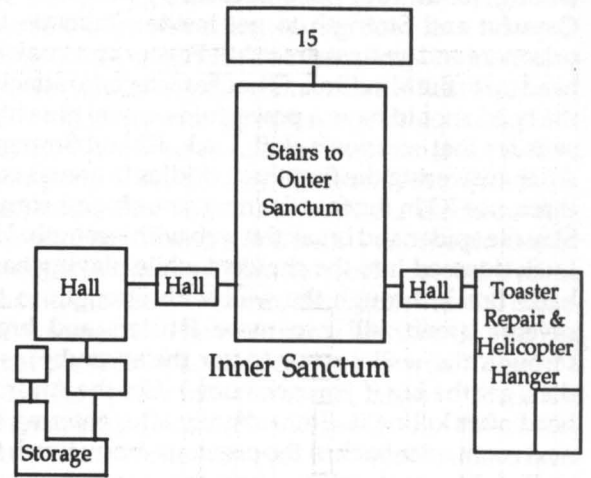

I

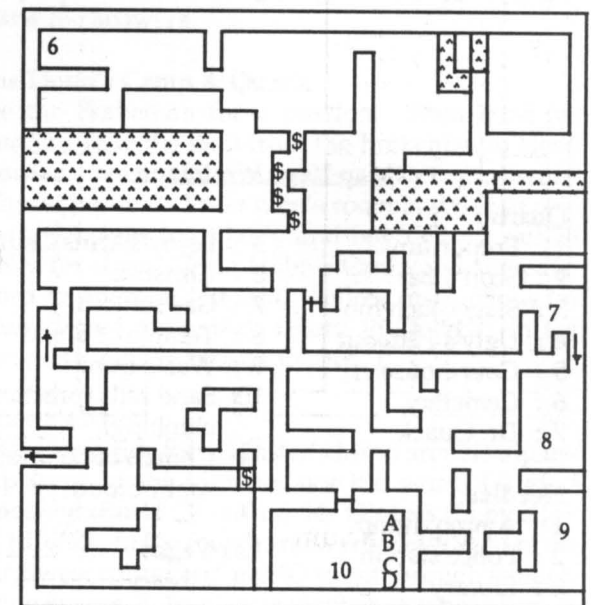
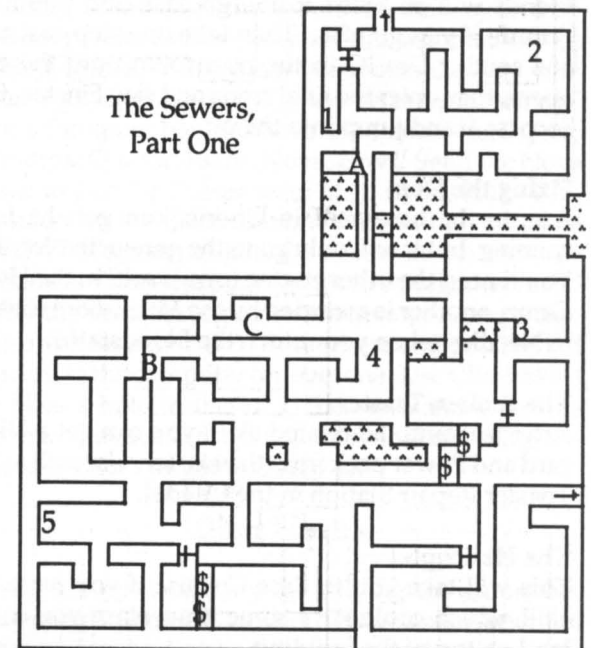

The Sewers, Part Two

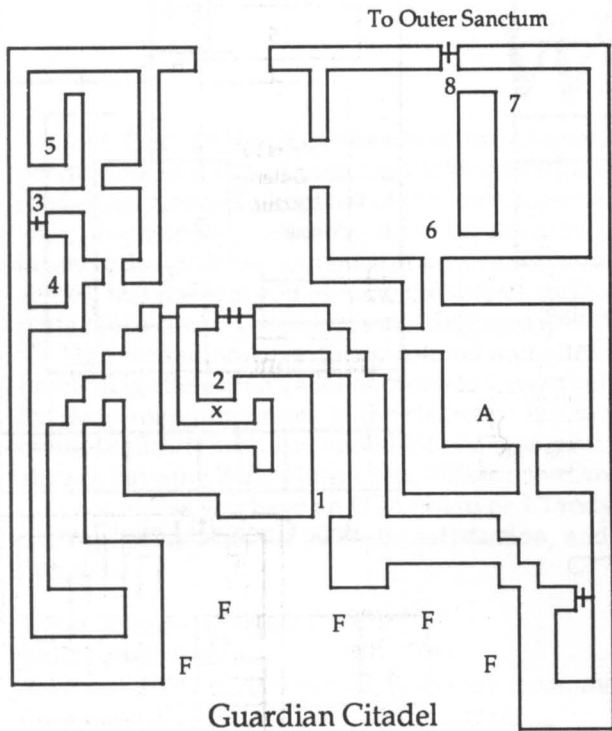

Guardian Citadel

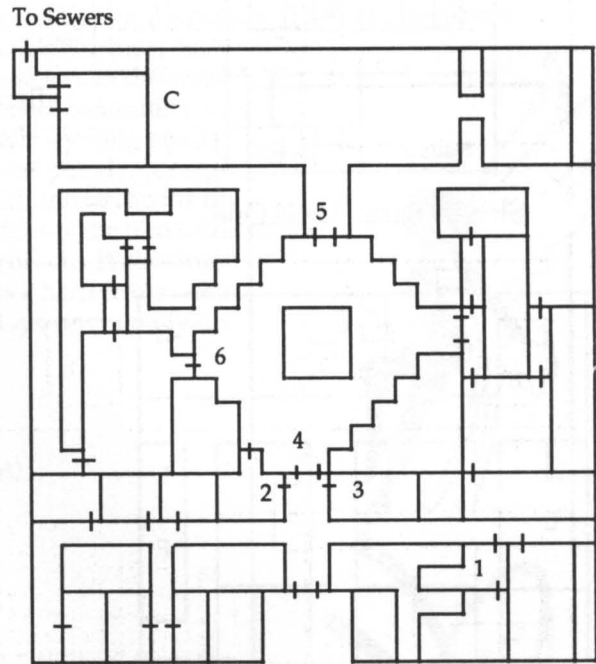

Temple of Mushroom Cloud: Las Vegas

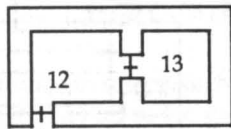

To Inner Sanctum

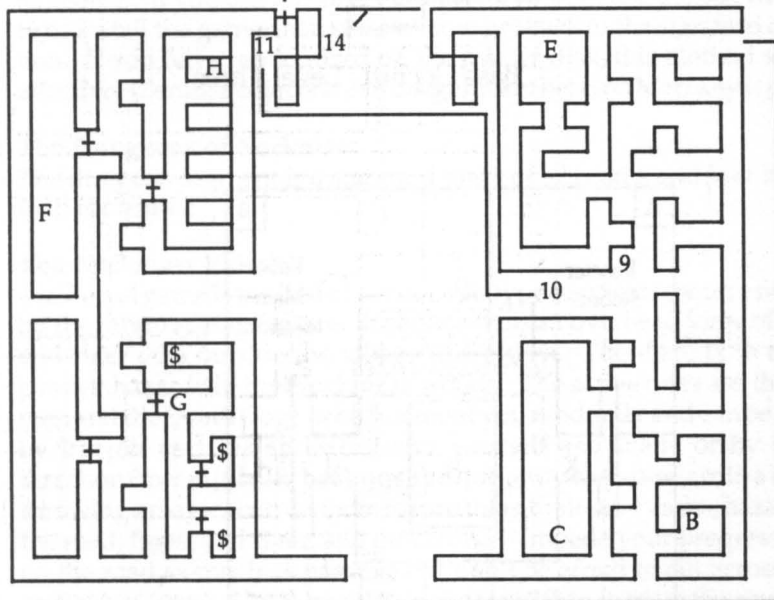

Outer Sanctum

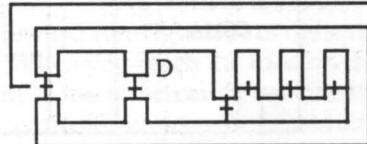

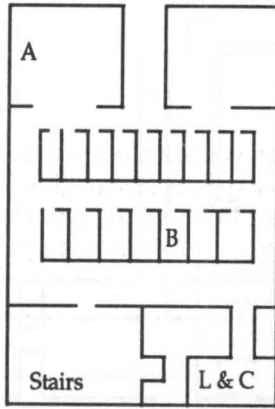

Sleeper Base: Level One

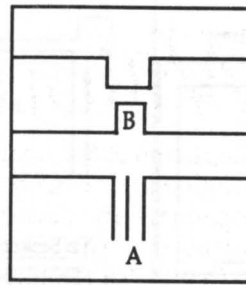

Base Cochise: Level One

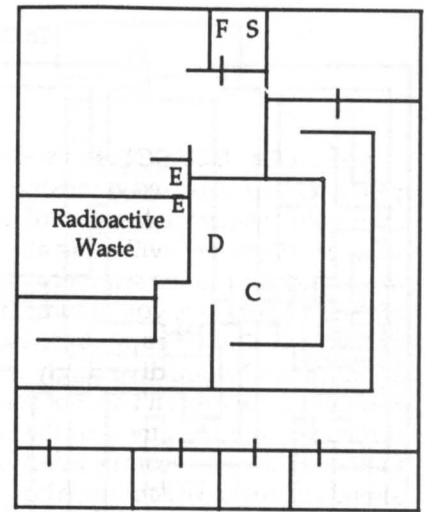

Base Cochise: Level Two

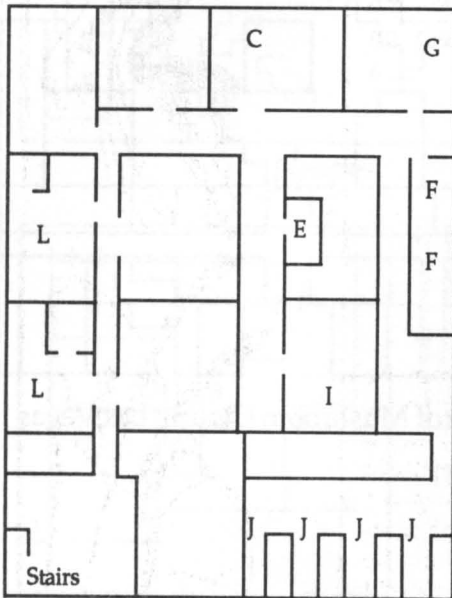

Sleeper Base: Level Two

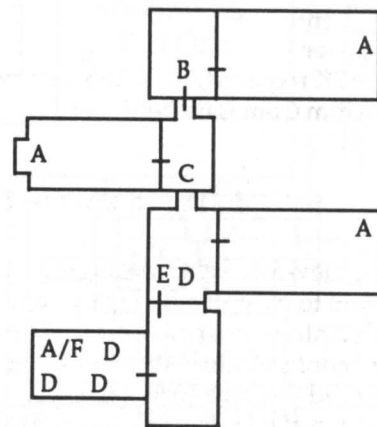

Base Cochise: Level Three

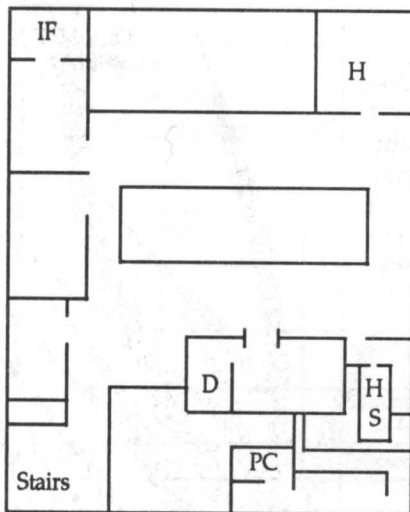

Sleeper Base: Level Three

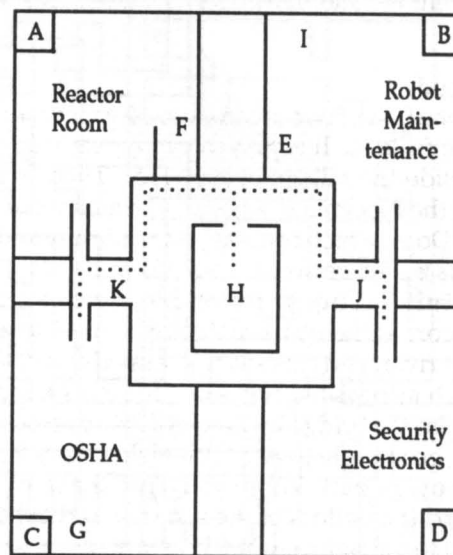

Base Cochise: Level Four

Willow

At the outset of this adventure adaptation of the Lucasfilm movie, you'll choose any of six independent but plot-linked games by clicking a magic wand on their names as they appear on a magic scroll. Each mini-quest reenacts a key part of the story; together, they make up the tale of Elora Danan, a newborn baby who, prophets say, will bring about the downfall of the evil Queen Bavmorda. They can be played in any order, or in the sequence of the events in the film. Unlike most such games, this one lets you assume the role of various characters in different parts of the story. Graphics (some digitized artwork, others computer art) are high-resolution, divertingly colored and one of *Willow's* strong points. Problem is, there aren't a lot of problems, especially logical puzzles: except for maze-mapping, most of the challenge lies in joystick (or keyboard or mouse) skills. It's recommended for younger gamers or fans of the film who already have the *Willow* lunch box, *Willow* t-shirt and the official *Willow* tree. (But not unless you have an EGA board or a Tandy, plus a hard drive—the CGA graphics offer no aesthetic satisfaction, and it plays *very* slowly on floppies.)

Type: Arcade Adventure

Skill Level: Beginner

Systems: IBM (512K required, hard disk recommended)

Company: Lucasfilm Games/MicroProse

The Solution

Use your pointing device to select the highlighted word "Willow" from the scroll, allowing you to play all of the game segments in order. If you pause too long or wander into a dungeon cell, you'll be thrown in jail. This solution is for the standard configuration. If you randomized the game, most of it will be useless. If you did this on a hard drive, you can use the SETUP program to uninstall the game, then reinstall it to get back to the standard configuration. If you have randomized on the master disk, this method will not be effective. (Because objects are so insignificant here, no Map Key is provided.)

The Dungeons of Nockmaar

The dungeon segment is a standard maze of 52 rooms and four levels. (See map for route.)

The Nockmaar Woods

The Forest game is the first of two arcade-type segments that are not affected by the randomizing feature. It is played on an overhead view of the forest and river area outside the village of Nelwyn. There are both active and passive hazards in the Nockmaar woods. The active ones are the Queen's men and the Death Dogs, which come at you randomly and can be dealt with by `lffqjoh usfft ps spdl` between yourself and them, or by facing the direction from `xijdi uifz bsf bqqspbdijoh` and, when they are in a direct line, throwing a magic acorn at them to turn them to stone. Passive hazards—the road, forest and river, and quicksand—impede your progress. Stay on the road as much as possible but don't be afraid to cut across small sections of forest. Use the bridge in the `tpvuifbtu` to cross the river. From your starting point, go straight towards the right side of the screen, crossing the forest at its narrowest part. When you reach the road on the other side, start down it toward the bottom of the screen and cross the bridge. Once across, head up and to the right as quickly as you can. If soldiers or dogs get near you, try zig-zagging a bit and hope they get sidetracked.

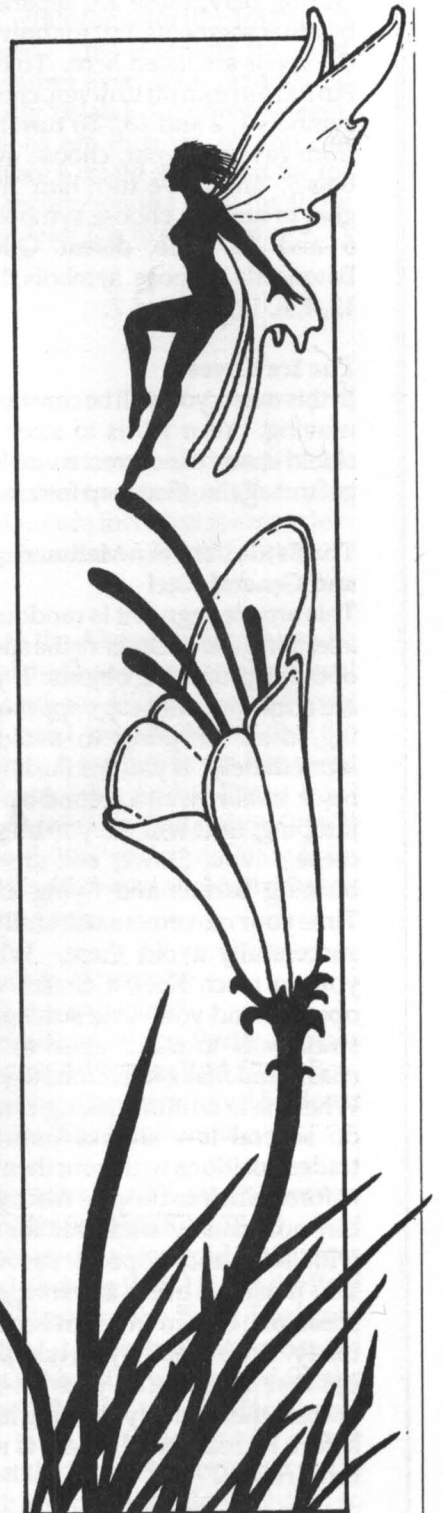

The Daikini Crossroads

To release Madmartigan from the dreaded Cages of Death, move your joystick upxbset uif dbhf po uif sjhiu and press the button.

Spellcasting

You must cast spells four times during the course of the game. During play, these are separated by other segments, but for brevity, the spells are listed here. To turn Fin Raziel from rat to raven, choose symbols 1, 2 and 13. To turn him from raven to goat, choose symbols 5, and 7. To turn him from goat to human, choose symbols 4, 6 and 12. To defeat Queen Bavmorda, choose symbols 1, 2, 13, 4, 6, 12, 5, 9 and 7.

The Ice Caves

In this maze, you will be constantly moving. Your job is to steer the shield down the correct tunnels to get out again. (See map for route.)

The Battle between Madmartigan and General Kael

This arcade segment is random to a certain extent. Observe the speed of the approaching objects. If you see a **tnbmm sfe bsspx** approaching, duck or jump to avoid it immediately. If you see the larger black javelin, wait a second before jumping, or it will get you as you come down. Slower still are the burning barrels and flying axes. Time your movements carefully to successfully avoid these. When you do reach Kael, a chasm will open behind you. One successful strategy is to stand close to the chasm and make Kael come to you. When he is within striking range, do several low slashes until he trades positions with you; then try to force him into the pit. Also, you can not usually trade hit for hit with Kael and hope to survive. You must use every advantage to sneak one or two in when he isn't ready. Try prodding him **tusbjhiu gpxbse** as soon as you get the chance, then quickly slashing high before he recovers. If there is still time, repeat.

Willow

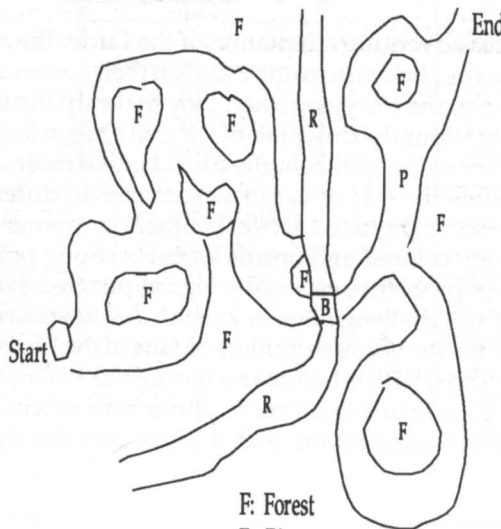

F: Forest
R: River
B: Bridge
P: Path

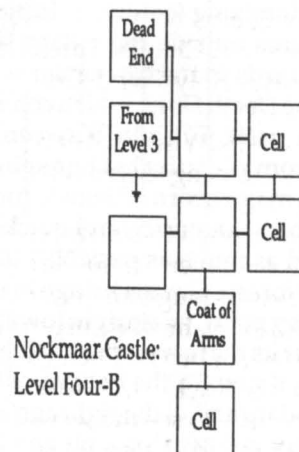
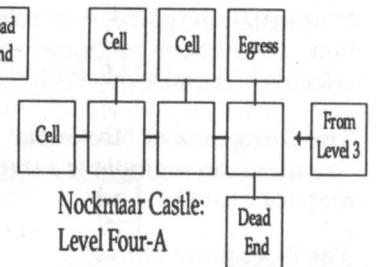
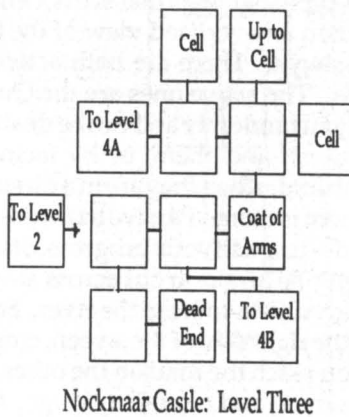
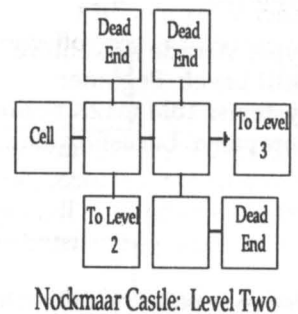
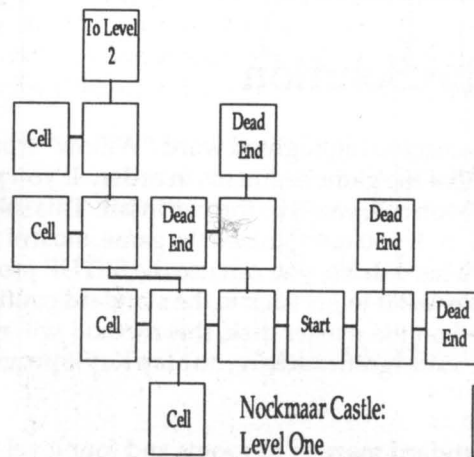
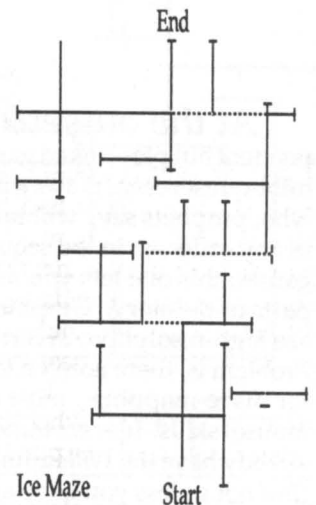

Wizardry IV: Return of Werdna

The fourth *Wizardry* is actually a sequel to the first one, in which you had to defeat the evil wizard, Werdna, and obtain a magic amulet. Here you assume the role of Werdna, trapped at the bottom of a series of mazes, who must fight his way to the top and reclaim that darned amulet. It is the first one-character scenario in the series, so you can't use characters from other scenarios. Instead, your party is composed of monsters who make their own combat decisions as you battle parties of adventurers. There

are more puzzles than in previous scenarios, but combat and mapping remain the essence of the game. Mazes are shown with the same simple line drawings in the first three games, while the color illustrations of monsters were enhanced. This is among the most difficult role-playing games ever, with maddening mazes and a very tightly balanced combat system. Five possible conclusions are in store, so you can finish it once, then restore a saved game and try for another ending. It's recommended only for those who have completed at least the first *Wizardry*.

Type: Fantasy Role-playing
Skill Level: Experts Only
Systems: Apple, IBM
Company: Sir-Tech Software

The Solution

When told to pick up an item, make sure you have an empty inventory slot a few moves beforehand. This game is tightly balanced, so expect to get killed a lot—even with the right answers and maps! The main combat decisions you'll make are your choice of monsters, and recommendations are included for most levels. Coordinates are listed as east, north and level: 4, 3, 1 means 4 east, 3 north on Level 1.

Level 10: Left or Right?

Artifacts: Black Candle, Amulet and Bloodstone
Effective Monsters: Priests, Creeping Coins

To exit the first room, you need Qsjftut jo uif qbsuz up dbtu NJMXB during combat and reveal the exit (dotted line). Defeat Guardians at (1), (2) and (3). Go S. and W. to P2 for more monsters and spell points, then N. to (4) to slay the Pyramid Guardian and get the Black Candle and Amulet. Now head to (5) for the Bloodstone and back to stairs to next level.

Level 9: Catacombs

Artifacts: Demonic Chimes, Lander's Turquoise, Holy Hand Grenade
Effective Monsters: Witches, Anacondas, Dusters, Creeping Crufts

The first time through this maze, defeat Guards in Corner Rooms for gold and items—though the only ones you *must* fight are uipf hvbsejoh uif tupof bu (1). Then go to (2) and use the black candle from the previous maze to see the secret door. Take stairs up. Later in the

game you will return to the Abyss (3), which can be entered once you've got the Dreampainter's Ka (Level 7) and are equipped with the Winged Boots (Level 5). You also need the Black Candle, the Demonic Chimes from this Level (see map) and a book (the Arabic Diary from Level 6) to enter Hell, where you'll get the "HHG" of Aunty Ock, a Holy Hand Grenade essential for completing the game

Level 8: "Death by a Thousand Cuts"

Artifacts: Golden Pyrite, Amber Dragon, Witching Rod, Black Box.
Effective Monsters: Level 5 Priests, Harpies, Shades, Ronins.

From the stairs, head E. into NE corner, then S. to Pentagram (P) at 18, 15. Stay on the unshaded trail to avoid land mines and get the Witching Rod (1) from the Pool at 14, 1. Then get the Black Box from Glum (2) at 1, 1. The Box gives you room to carry all the DIOS you'll need for the next phase. Return to uif Qfoubhsbn, then go N. to 19, 19, W. to the NW corner and S. to get the Pyrite Stone (3) at 0, 9. Go W. through the one-way door and N. to



the Pentagram. Return for the Dragon (5). (See below for alternate strategies.)

You may be able to accomplish the final part of this maze with a team from this level's Pentagram, but it's easier if you take the stairs up to Level 7 and get a stronger crew of monsters, not to mention Level 4 character status and its 40 hit points. (When summoning monsters on 7 for use on 8, don't forget Level 5 Priests.) Regardless, you'll need lots of DIOS, so devote time to seeking out monsters until you have at least 10 DIOS. Since you don't need them immediately, an easier strategy is to retrieve Pyrite and Dragon after obtaining the Winged Boots from Level 5, which allow you to float over mines. But if you insist on doing it the hard way: from 5, 4 go 1 N., then W. (through the mines) for Amber Dragon (4) at 0, 5 and on through the one-way door (see solid line on map). (Camp and vtf EJPT fbdi ujn f iju qpjout gbmm to 10-15.) Follow the trail back to the Pentagram before heading on to stairs in the SW corner.

Level 7

Artifacts: Orange Rod (Hopalong Carrot), Dreampainter's Ka, Sword of West Wind, Sword of East Wind, Dragon's Claw (you can only take one)
Effective Monsters: Priestesses, Goblin Shamans

After climbing the stairs from Level 8, you pass through an area that negates your Light spell. Use the candle for light to see the hidden door (1) at 8, 13, facing N. Make your way to the Altar (2). To obtain one of three swords, equip the three stones (Bloodstone, Lander's Turquoise and Amber Dragon) and put them on the altar. (The Dragon's Claw will restore hit points. The East and West Wind Swords have excellent hitting power. Save the game before dipptjoh b txpse if you want to replay it, since your choice of sword determines three of the endings.) The first time through this level, all you can do now is head for the Stairs Up.

Later, after obtaining Winged Boots from Level 5, you can equip them to visit the Blimp (3) and get the Orange Rod (4). (The Oxygen Mask from 9, 18 on Level 5 helps you resist the Mage's spells on Level 7.) Take it to the hidden door (5) at 5, 8, gbdf fbtu boe jowplf it to enter the Dreampainter's Room for the Dreampainter's Ka (6). (Do not equip the Dreampainter's Ka yet—it is necessary for the ending, and has only a limited number of uses.) But don't wear the Boots into the Dreampainter's Room, and don't invoke them unless you're wearing them. (The Blimp's Clue: Sale—Lych Gates at Baltec's)

Level 6: Whirling Dervish

Artifacts: St. Rimbo's Digit, Initiate Turban, Arabic Diary, Cape of Good Hope
Effective Monsters: Wights, Bishops, Master Ninjas

Lots of Spinners and False Doors make this maze frustrating until you learn how to determine your location. The Jeweled Amulet casts a Dumapic, but you can also tell where you've been spun to by uftujoh uif eppst up tff jg uifz'sf sfbm ps gbmtf. If both are false, for example, you have entered a horizontal row; if the door nearest you is real, you have moved north; if the door nearest you is false and the one further away is real, you have moved south.

First get the Cape of Good Hope (1) at 13, 13. After defeating one of this level's strong parties of monsters, you'll receive St. Rimbo's Digit (this may happen before you get the Cape). If equipped, it casts Tiltowait in battle. (The number of times it can be used is limited and appears to be random.) Then go to (2), the door at 1, 1, which can't be seen even with a Light spell—you must kick there to open it. This leads to a tough battle, so save before entering the hidden room for Initiate Turban and Arabic Diary. You'll be transported to the Stairs Up. (The stairs do not bqfbs vomftt zpv bsf usbotqpsufe gspn (2), and disappear if you don't use them when asked.)

Equipped and invoked, the Cape of Good Hope lowers your Armor Count and boosts your spell-casting and hitting power. The Arabic Diary is the book needed to enter the Gates of Hell on Level 9. The Initiate Turban casts a Halito (but hold onto it for the end game).

Level 5: Creatures of Light and Darkness

Artifacts: Winged Boots, Oxygen Mask
Effective Monsters: Hellhounds, Master Dragons, Priests of Fung

Numerous areas of bright light make it hard to stay oriented. Get the Winged Boots (1), then go for the Oxygen Mask (2). (These enable you to return and complete Level 7, though you can do it with the Boots alone. The Boots also enable you to fly over mine fields on Level 8. Don't invoke them vomftt frvjqqfe; also, they may disintegrate at any time, in which case you should return here for another pair. The Mask protects against air breather spells like Makanito.) Somewhere on this or higher levels you may obtain a "furred cone" (Magician's Hat) after a battle. This is required by the Witch on Level 4 as an ingredient for her "blue blood special" (a Dab of Puce).

Level 4: Maze of Wandering

Artifacts: Aromatic Ball (White Marble), Limp Wrist (after battle)
Effective Monsters: Carriers, Scrylls, Dark Riders

Shifting walls make this a tough maze. The best strategy is to head straight for Level 3 and enter the Cosmic Cube. Then return to this and other mazes to complete the game. It is crucial to xfbs uif Pzfhfo

Nbtl here. Don't proceed without a "Get out of Jail Free card" obtained after a battle. If you find a Limp Wrist after a battle, keep it—it's needed for four of the game's five endings.

Just gpmmpx uif epuufe mjof. The walls will shift until you reach 0, 10. Then you must camp and decamp until you have an opportunity to move west. This happens one time out of four. The next obstacle is the Jail (2) at 18, 13. You must have a "Get out of Jail Free card" (see above). Use it to free yourself from Jail until you are freed at 17, 13 (one square west of the Jail). This also occurs once in four times. Then follow the dotted line to the Stairs Up, bwpjejoh uif "usjhhfs trvbsft." Head upstairs. (Later, you will return to deal with the Witch (1), which is covered below.) Before leaving, bathe in the Ron Wartow Memorial Pool.

Levels 3, 2 and 1: The Cube

Throughout this section, follow the dotted lines on the maps. You travel through a series of chutes and stairs that transport you about these three levels. On the maps, each intermediate destination labeled with a lower case letter: (a). In this explanatory information, each letter is followed by a number indicating the level on which it's found: (a/3).

From Level 4, you arrive on Level 1 at the spot marked X (15, 11). Go due north through the center door and continue north until you're transported to (a/3). Go west, where you're transported to (b/1). You must get through this Light and Dark area (avoiding 3, 1) to 3, 9, where a chute transports you to (c/2). Frvjq pyzhfobtl. Move to 5, 7, where another chute sends you to (d/2).

Frvjq boe jowplf uif Xjohfe Cpput to avoid pits in these areas. Go to 3, 14, 2 and get the Oil of Olé (50,000 gold) at (1). Find your way to the stairs down at 10, 8 to reach (e/3), then follow the map and move to C1 to be transported to (f/3). (Be careful to avoid stepping in any other locations along the way, or you'll be transported all over the place.) Move south once and west once and you'll be transported to (g/3). Now go opsui podf and east once to be transported to (h/3). Take the stairs up at 19, 17 to reach (i/1). At (1) on Level 1 (13, 2), get Trebor's Rump. Equipped and invoked, it permanently stops Trebor from hounding you. Make your way to 8, 2 for a chute to (j/2). Proceed to the stairs up at 18, 2, which take you to (k/1). Follow route to stairs down at 9, 9 to (l/3). Follow the hall to C6 and get transported to (m/1). Go to the stairs down at 8, 5, which take you to (n/3). Move to 1, 2, where you're transported to (o/2).

Filled with spinners, this room is a *major* challenge. Cast Evnbqjd to ascertain you're facing south and save, then move south, repeating the process until

you reach 9, 2, 2. You can also use Light spells to watch distant walls. Save and try until you get into Chute C6, which transports you to (p/1). Freedom from the Cube is in sight! The Holy Hand Grenade is cursed and must be cleansed by using the Oil of Olé. Then use the Holy Hand Grenade. When the pin is pulled, make your way to (2) at 15, 15, 1, drop the Holy Hand Grenade and move three steps away. The wall will be blown away, allowing access to the stairs up at 15, 16, 1.

Back to See the Witch

Use Malor to backtrack and satisfy the Witch on Level 4. She wants the Gold Pyrite (Level 8), White Marble (Level 4), Witching Rod (Level 2) and several items obtained after battle: a Magician's Hat, Blade Cuisinart and Penneceaux.

Levels -0, -01 and -02: The Castle

Artifacts: Maintenance Cap, Chrystal Rose, Gwilym's Arrow of Truth, Orb of Dreams, Signet Ring, Mythical Gauntlets
Effective Monsters: Greater Demons, A Flack, and Entelechy Fluff

Regardless of which ending you opt for, the following things must be accomplished. You should also have 1,000,000 in gold. (Gjhiu npotufst po Mfwfm pof until you have enough.) The Dreampainter's Ka is needed to survive a major battle, but don't equip until then, for it has a limited number of uses.

Return to Level -0, go east and north to the Castle Entry (1). The password is usfcps tvy. Go to 2, 15 and take the stairs up to Level -01. Go north three, east thirteen (stay on the "catwalk" by following the dotted line, or you'll fall off), south two to 16, 16, -01. Take stairs up to Level -02. Move north once and obtain the key from the Inkeyper (1).

Retrace your steps to Level -0. Enter door at (4), found at 17, 9, which cannot be done with the Inkeyper's Key. Go to 14, 11, -0 and take the stairs up to Level -01. Enter (6), the room at 15, 13, -01, where as a reward for restoring the Temple on Level 7, you'll get a Maintenance Cap. This enables you to sfqbjjs uif Dbtumft Gpvobjot (2) at 5, 16, -0 and 13, 16, -0. After doing so, bathe in the fountain at 5, 16, -0, then go immediately to 15, 11, -01 and you'll be presented with the Chrystal Rose (7). When equipped with the Rose, you'll be honored by all and attacked by only the most formidable foes. On Level -01 at (4) in room at 14, 11, get Gwilym's Arrow of Truth for the Dab of Puce. At (5) on the same level, get the Orb of Dreams at 14, 13 for the Penneceaux.

Ending One: The Acceptance of Offer

Go to 9, 16, -0 for an encounter with the Captain's Council (6), which results in a request for 1,000,000

gold. Comply, go one step south and take the stairs up at 9, 15, -0. Go to the Baron's Council (1) at 8, 16, -01 for the Signet Ring. Before taking the stairs up at 16, 16, -01, equip the Dreampainter's Ka and the Oxygen Mask, which are needed to get past the All-Stars. Then go to 9, 15, -02 for the Acceptance of Offering conclusion at (2).

Endings Two-Four: The Sword Endings

For these, you must have done the above, except giving the 1,000,000 gold to the Captain's Council. You also need the Dreampainter's Ka, an Initiate's Turban (obtained after battle), a Limp Wrist (obtained after battle around Level 4) and a Dink (a level one monster) in your party instead of a Flack. After getting the Signet Ring, go to the stairs up at 16, 16 on Level -01, equip the Dreampainter's Ka and Oxygen Mask, then save the game. After you make it past the All-Stars, get the Mythical Gauntlets (3) at 9, 17, Equip them. You can't get past Hawkwind (4) without a Ejol. Then go to (5) for the Sword Ending. The only difference between these three conclusions is based on which of the swords you chose at the Temple.

The Grandmaster Ending

Hey! Every hardcore adventurer needs at least one Mount Everest to climb, so we're not publishing this one. Subscribers to QuestBusters, however, can get free hints by sending a self-addressed, stamped envelope with up to three questions at a time. (Hint: There is one more level, and you already have what you need to reach it.)

Map Key: Wizardry IV

All Levels

P : Pentagram
SU : Stairs Up
SD : Stairs Down
R : Rock

Level 10

1 : 1st Guardian
2 : 2nd Guardian
3 : 3rd Guardian
4 : Pyramid Guardian: Amulet and Candle
5 : Bloodstone

Level 9

1 : Turquoise Stone
2 : Secret Door
3 : The Abyss
4 : Dog Beast & Demonic Chimes
5 : Monster
W: Corner Rooms are full of Tower Sentries, Tower Guards and Officer's Mess

Level 8

1 : Witching Rod in Acid Pool
2 : Glum (defeat for Black Box)
3 : Golden Pyrite
4 : Amber Dragon (stone)

Unshaded area is safe path through mine fields, which are more severe as you go further south.

Level 7

1 : Temple/Altar
2 : Orange Rod (Hopalong Carrot)
3 : Blimp with Message
4 : Statue of Dreampainter & Dreampainter's Ka
5 : Hidden Door (Use Candle to See)
Dotted Areas: Bright Light (Light Spell Negated)

Level 6

1 : Sentinel-Cape of Good Hope

(Answer—The Bnvmfu)

2 : Sentinel—Initiate Turban, Arabic Diary, Transport to Stairs Up
T : Sentinel—Transport to Pentagon (or two squares away)
F : False Door
X : Spinner
TP: Transporter (to random location)

Level 5

1 : L5 Creature and Winged Boots
2 : Message and Oxygen Mask
D (#): Dark Creature (# is its level)
L (#): Light Creature
T1: Transport to 0N, 16E
T2: Transport to 2N, 11E
Bright Light (Light Spell Negated)

Level 4

1 : Witch: Triggers wall changes
2 : Jail
3 : Aromatic Ball(White Marble)
4 : Ron Wartow Memorial Pool
R: Rock
T: Triggers wall changes

Level 3 (The Cube)

No artifacts are found here. See map for chutes and stairs.

Level 2 (The Cube)

1 : Oil of Olé
2 : Rock

Level 1 (The Cube)

1 : Trebor's Rump (Invoked, it lifts curse so Trebor stops following you.)
2 : Use HHG to blast open wall
X: Entrance to Cube from Level 4 SU at 15, 16: entrance to Castle

Level -0 (One up from Cube)

1 : Castle Entrance (password needed — usfcps tvx)
2 : Majestic Fountains
3 : Entrance to Citadel of Castle
4 : Entrance to Inn (need Brass Key from Inkeyper)
5 : Baltac
6 : Captain's Council (wants \$1M gold for Rallying Horn, or you must go to battle). You must be equipped with Chrystal Rose from next maze.)

Level -01 (Two up from Cube)

- 1 : Baron's Council & Signet Ring (Wax Seal)
- 2 : Elevator
- 3 : Elevator
- 4 : Gwilym's Arrow of Truth (for Dab of Puce)
- 5 : Orbof Dreams (for Penneceaux)
- 6 : Maintenance Cap (Must Have

Restored Temple on 7)

- 7 : Chrystal Rose
- Level -02 (Three up from Cube)**
- 1 : InKeyper (Key to Inn, 1 Up from Cube)
 - 2 : One Game Ending: Acceptance of Offer
 - 3 : Mythical Gauntlets

- 4 : Hawkwind (Must have Dink to defeat him)
- 5 : Four More Game Endings, one with each of the three Swords from the Temple on 7, and the Grandmaster Solution.
- 6 : Elevator
- 7 : Nyin

Wizardry IV: Level 10

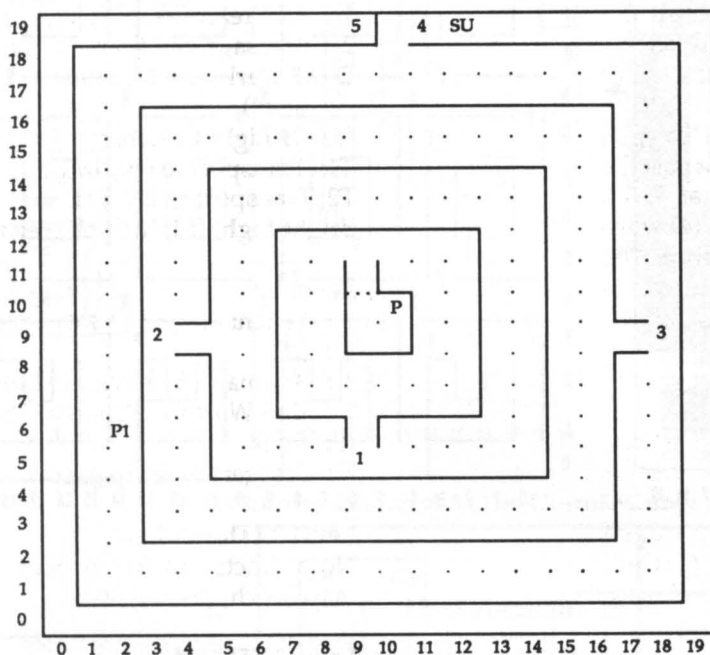

Wizardry IV: Level 9

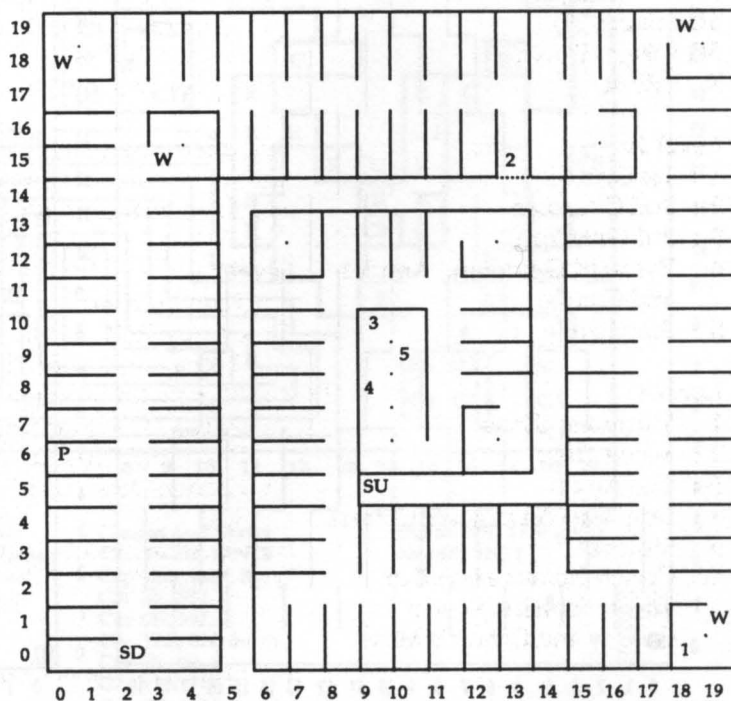

Wizardry IV: Level 8

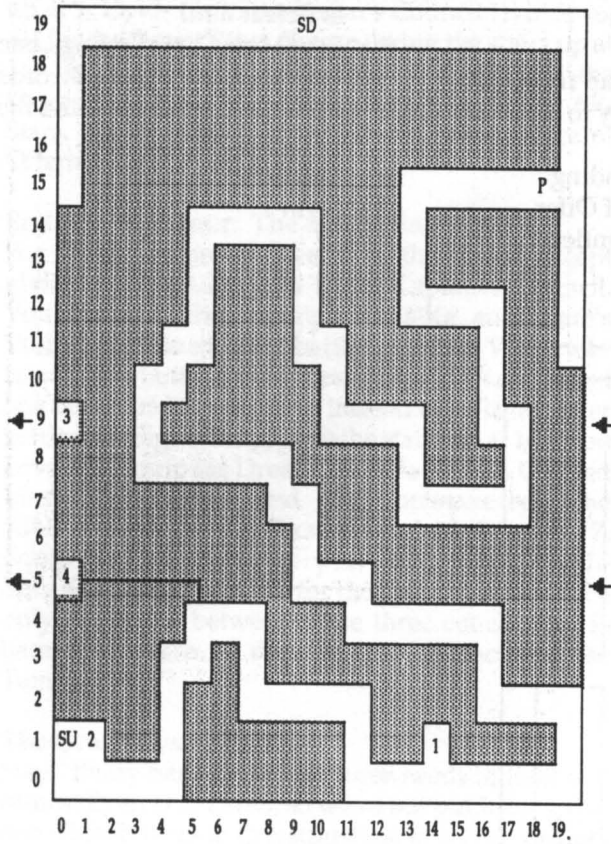

Wizardry IV: Level 6

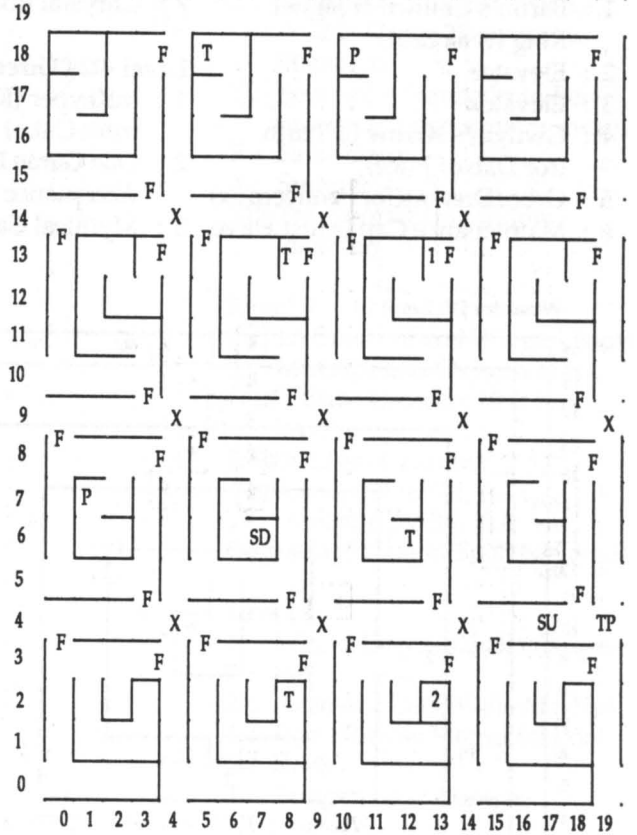

Wizardry IV: Level 7

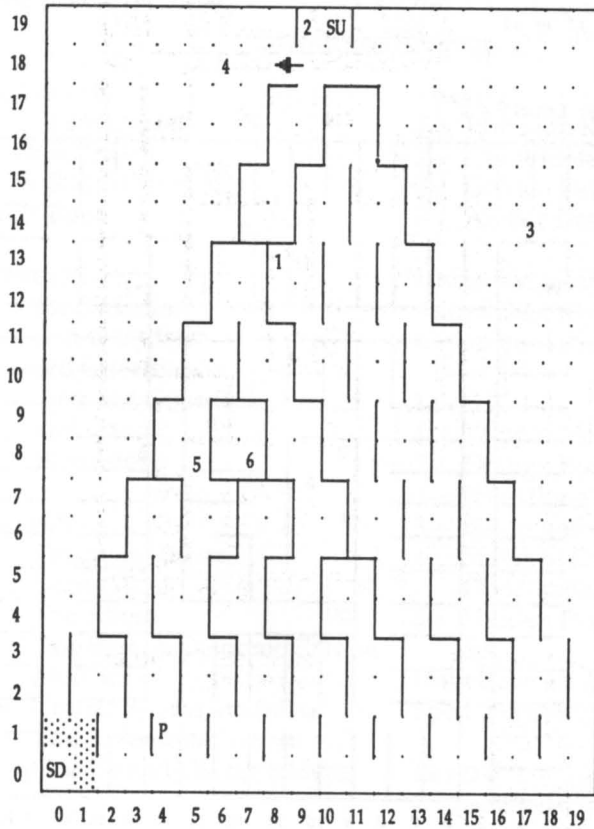

Wizardry IV: Level 5

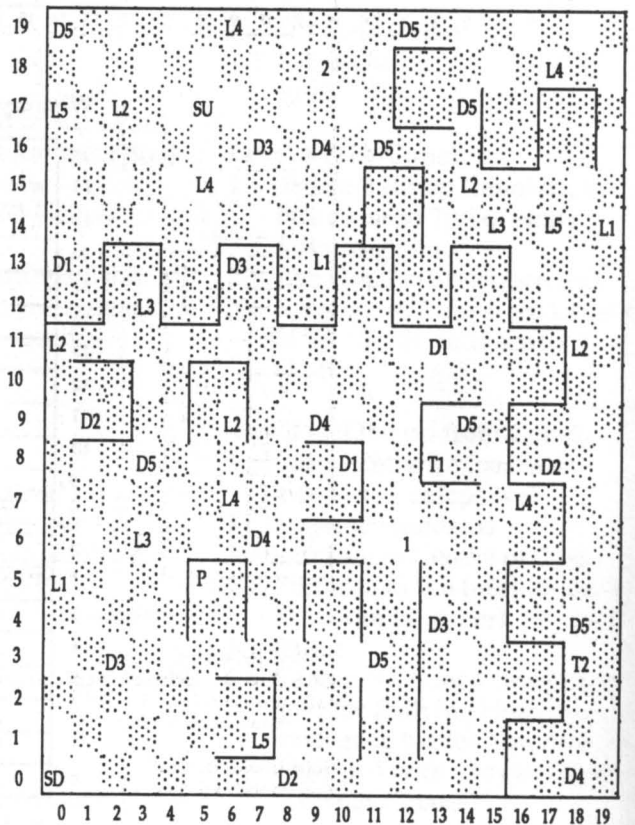

Wizardry IV: Level 4

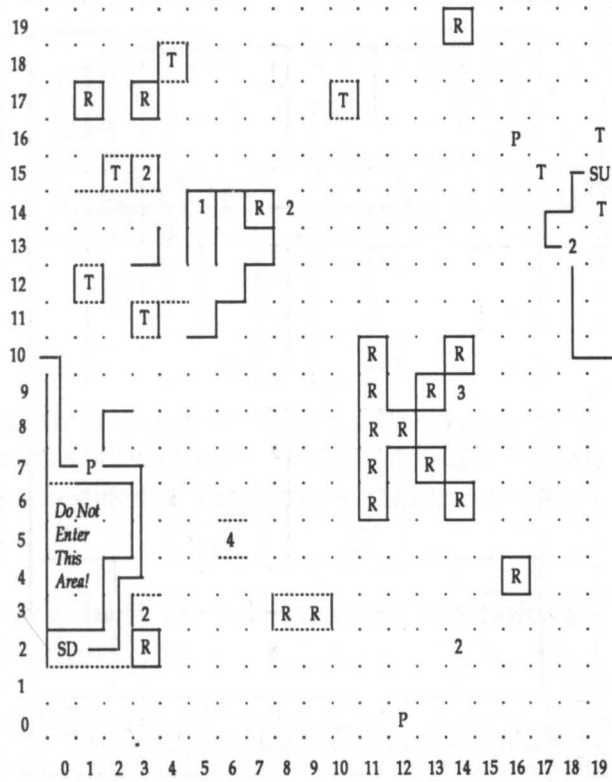

⋮ : Changing Walls

Wizardry IV: Level 2 (The Cosmic Cube)

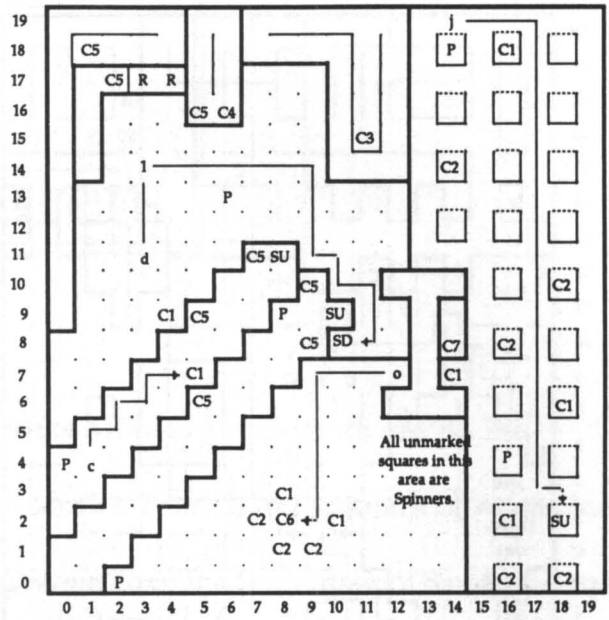

- Chutes
 C1: To 3E, 11N, 2
 C2: 19E, 14N, 3
 C3: 2E, 17N, 1
 C4: 9E, 19N, 1
 C5: 3E, 2N, 2
 C6: 18E, 14N, 1
 C7: 13E, 9N, 1

SD at 10E, 8N go to 10E, 9N, 3
 SU at 18E, 2N go to 0E, 7N, 1

Wizardry IV: Level 3 (The Cosmic Cube)

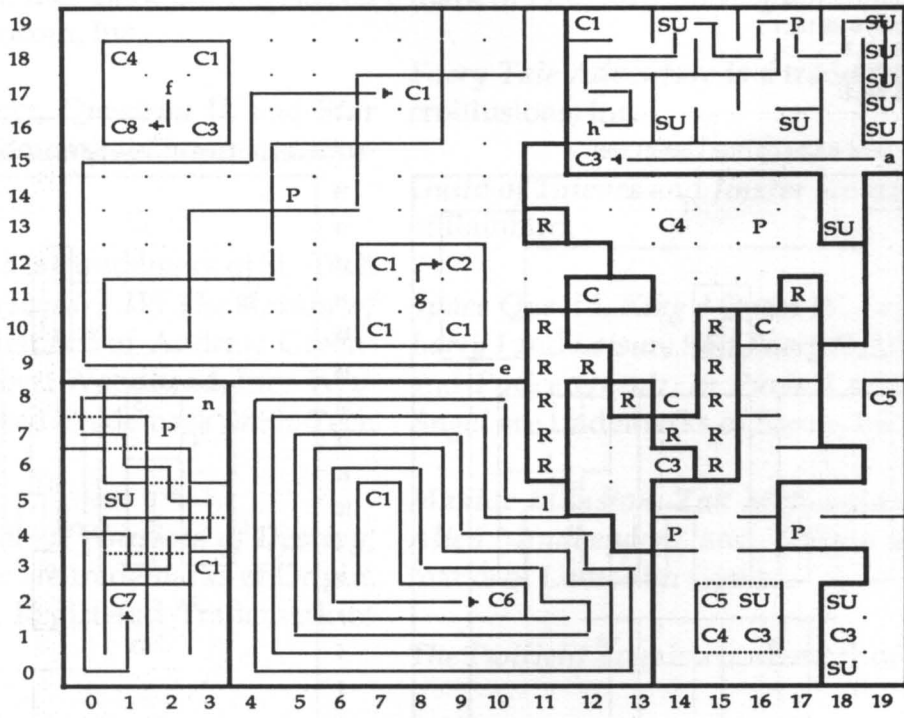

Dotted lines indicate best path through maze (but you can step off the trail to visit Pentagrams, of course.)

Bold lines indicate self-contained areas.

- Chutes and Stairs
 C1: To 2E, 17N, 3
 C2: 12E, 16N, 3
 C3: 3E, 5N, 1
 C4: 0E, 9N, 2
 C5: 12E, 8N, 3
 C6: 3E, 00, 1
 C7: 12E, 7N, 2
 C8: 8E, 11N, 3

SU at 19E, 17N go to 16E, 3N, 1

Wizardry IV: Level 1 (The Cosmic Cube)

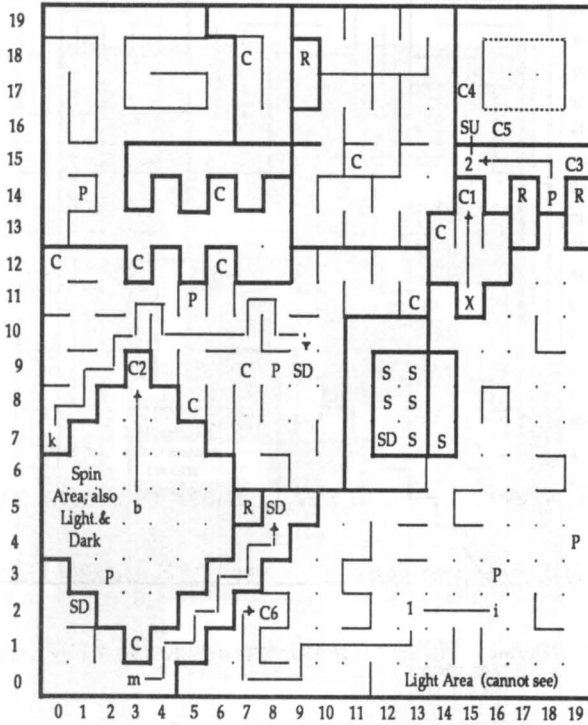

- Chutes
 C1: To 19E, 15N, 3
 C2: 1E, 4N, 2
 C3: Stairs Up—Red Herring,
 actually to 15E, 11N, 1
 C4: 12E, 19N, 2
 C5: 14E, 8N, 3
 C6: 16E, 19N, 2

SD at 9E, 8N go to 11E, 5N, 3
 SD at 7E, 5N go to 3E, 8N, 3

Wizardry IV: Level -01 (Two Up From Cosmic Cube)

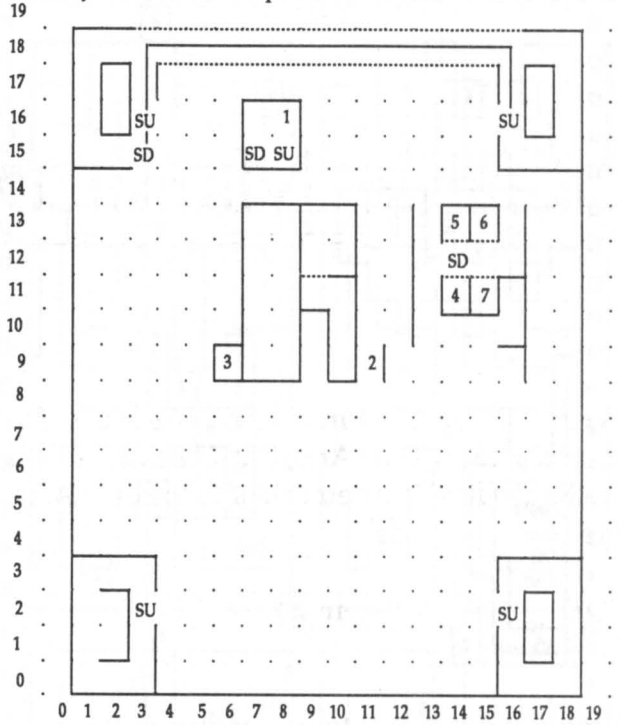

Note: Do not cross smaller dotted lines, which represent the sides of the catwalk, or you will fall.

Wizardry IV: Level -0 (One Up From Cosmic Cube)

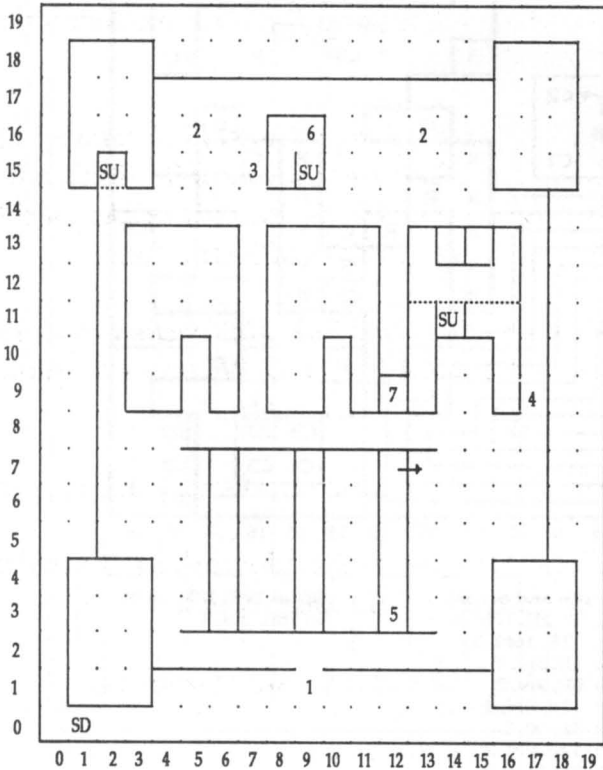

Wizardry IV: Level -02 (Three Up From Cosmic Cube)

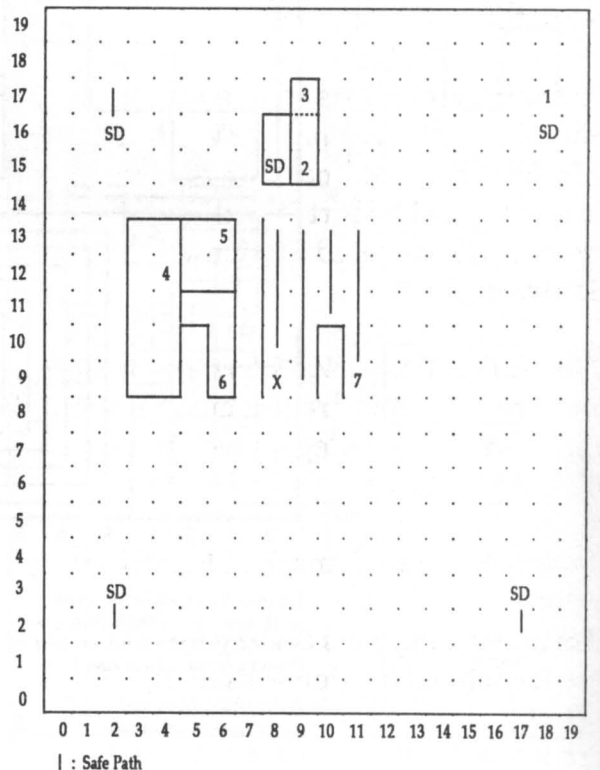

| : Safe Path

Game Manufacturers

Wasteland and *Return to Atlantis* are trademarks of Electronic Arts, Inc. *The Bard's Tale* is a Registered Trademark of Electronic Arts, Inc.

Dark Lord a trademark of The Software Toolwork, Inc.

Plundered Hearts, Quarterstaff: The Tomb of Setmoth, Sherlock Holmes: The Riddle of the Crown Jewels, and *Beyond Zork* are trademarks of Infocom, Inc. *Zork* is a Registered Trademark of Infocom, Inc.

The Eternal Dagger, Questron II, and *Star Command* are trademarks of Strategic Simulations, Inc.

Seven Spirits of Ra is a trademark of Sir-Tech Software, Inc. *Wizardry IV: The Return of Werdna* is a trademark of Andrew Greenberg, Inc. and Robert Woodhead, Inc. *Wizardry* is a Registered Trademark of Sir-Tech Software, Inc.

2400 A.D., Ultima V: Warriors of Destiny, and *Times of Lore* are trademarks of Origin, Inc. *Ultima* is a Registered Trademark of Richard Garriott.

Talisman is a trademark of PolarWare, Inc.

Advanced Dungeons & Dragons and *AD & D* are Registered Trademarks of TRS, Inc.

Alien Mind is a trademark of PBI, Inc.

Azarok's Tomb is a trademark of Aegis, Inc.

Dream Zone is a trademark of Baudville, Inc.

Tower of Myraglen is a trademark of PBI, Inc.

Dondra is a trademark of Sean Barger.

Dr. Dumont's Wild P. A. R. T. I. is a trademark of First Row Software.

Faery Tale Adventure is a trademark of Microillusions, Inc.

Guild of Thieves and *Jinxter* are trademarks of Rainbird.

Space Quest I, King's Quest IV, Leisure Suit Larry I and *Leisure Suit Larry II, Manhunter* and *Police Quest: In Pursuit of the Death Angel* are trademarks of Sierra, Inc.

Maniac Mansion, Zak McKracken and the Alien Mindbenders, and *Willow* are trademarks of Lucasfilm Games.

The Twilight Zone is a trademark of CBS, Inc.

These titles are not trademarked. They are published by Mindscape, Inc.

Deja Vu, The Colony, and *Uninvited.*

Help! Mr. Wizard!

Orcs to the left of you, Kobolds to the right - and yet another locked door blocking your only escape from the Maze of Madness, where you've been wandering hopelessly without a map or a clue for weeks. What's a "dungeon desparado" to do? If you've one of the 40 quests covered in **QUEST FOR CLUES™II**, just look it up, decode the clue or consult the map that will steer you in the right direction - and don't forget to wipe out those Orcs and Kobolds before stepping through that portal into the next labyrinth.

QUEST FOR CLUES™II reveals complete solutions, with clues written in code so you won't spoil your fun by reading too much when all you need is a single password or the location of that darned Sword of Shaffer. And all maps necessary for each quest's solution are included to keep you on the right path once you get your bearings.

Free Subscription to QUESTBUSTERS™!

Each issue of **QUESTBUSTERS™**, *The Adventurers' Journal*, gives you one or more complete solutions to recent adventure and role-playing games, plus lots of clues to others. **QUESTBUSTERS™** also reviews the latest quests for *all* computer systems - and you can get a **FREE THREE-ISSUE SUBSCRIPTION** with the coupon inside this book! No puzzles to solve, no monsters to slay, no mazes to map! (It *does* help if you correctly spell your name and address on the coupon.)

Games covered in QUEST FOR CLUES™ II:

Azarok's Tomb.....	5	Police Quest I.....	51	The Eternal Dagger.....	111
Beyond Zork.....	7	Sherlock Holmes and		Faery Tale Adventure.....	118
Dark Lord.....	10	the Riddle of the		Quarterstaff: The	
Déja Vu.....	13	Crown Jewels.....	54	Tomb of Setmoth.....	121
Dondra: A New		Space Quest II.....	57	Questron II.....	125
Beginning.....	16	Talisman.....	60	Return to Atlantis.....	129
Dr. Dumont's Wild		The Twilight Zone.....	63	Seven Spirits of Ra.....	131
P.A.R.T.I.	18	Uninvited.....	66	Star Command.....	134
Dream Zone.....	21	Zak McKracken and the		Tangled Tales.....	139
Guild of Thieves.....	24	Alien Mindbenders.....	69	Times of Lore.....	146
Jinxter.....	27	Role Playing Games.....	75	Tower of Myraglen.....	149
King's Quest IV.....	30	2400 A.D.	76	Ultima V: Warriors	
Leisure Suit Larry I.....	35	Advanced Dungeons		of Destiny.....	152
Leisure Suit Larry II.....	37	and Dragons.....	83	Wasteland.....	162
Manhunter: New York.....	41	Alien Mind.....	94	Willow.....	171
Maniac Mansion.....	46	The Bard's Tale III.....	98	Wizardry IV: Return	
Plundered Hearts.....	49	The Colony.....	106	of Werdna.....	173



P.O. Box 161750 • Austin, TX 78716

ISBN 0-929373-01-4

QUEST FOR CLUES II



0 17814 74099 2