

THE BOOK OF
ADVENTURE
GAMES



BY KIM SCHUETTE

ARRAYS, INC.
The Book Division

THE BOOK OF



BY KIM SCHUETTE

ARRAYS, INC.

THE BOOK DIVISION

11223 South Hindry Avenue • Los Angeles, CA 90045

Credits

Book Design & Graphics
Estela Montesinos

Editors
Nancy Hays
Robert P. Wells

Precis
Elizabeth Anders

Typesetting
Argelia Navarrete
Mark Mansell

Graphics Assistants
Virginia Adams
Steve Gunn

Proofreader
Mark Bodziak

Line Drawings by
Jennifer Boynton on pages 9, 16, 108, 121, 131, 143, 154, 165, 172, 223

Computer Illustrations by
Mia McCroskey on pages 36, 53, 57, 71, 81, 136, 140, 167, 170, 174, 175, 209, 230, 236,
238, 239, 243

ISBN 0-912003-08-1

Copyright 1984 © Arrays, Inc./The Book Division. All rights reserved. Printed in the United States of America. No part of this publication may be reproduced, stored in a retrieval system, or transmitted, in any form or by any means, electronic, mechanical, photocopying, recording, or otherwise, without the prior written permission of Arrays, Inc./The Book Division.

The use of trademarks or other designations is for reference purposes only.

Dedication

This book is dedicated to my loving computer widow who, during the play of these games, was only once compelled to attack the Apple with a large knife. It is also dedicated to the world of frustrated adventurers who have for so long wondered where their next clue was coming from.

TABLE OF CONTENTS

PREFACE	viii
INTRODUCTION	1
Categories of Adventures	2
History of Adventures	2
What Makes a Good Adventure?	4
How to Tackle an Adventure Game	5
Mapping the Game	5
Inventory Management	6
Using This Book	6
THE GAMES	7
SOLUTIONS	245

Game	Description	Maps	Solutions
	Page #	Page #	Page #
Adventure	9	10-13	247-248
Adventureland	14	15	248
Adventure in Time	16	17-18	249
Ali-Baba and the 40 Thieves	19	20-21	none
Beneath Apple Manor	22	none	none
Birth of the Phoenix	23	23	none
Blade of Blackpoole	24	25	250
Castle of Darkness	26	27-28	251
Chambers of Xenobia	29	29	252
The Count	30	30	253
The Coveted Mirror	31	32-33	254-255
Cranston Manor	34	35-37	256-257
Creature Venture	38	38-41	258
Crime Stopper	43	42-43	259
Crypt of Medea	44	45	260
Crystal Caverns	46	46-47	261-262
Curse of Crowley Manor	48	49	263
Cyborg	51	50-53	264-265
Dark Crystal	54	55-56	266
Deadline	57	58-59	267

Death in the Caribbean	60	61-62	268
Demon's Forge	63	63	269
Doom Valley	64	65	270
Earthquake—San Francisco, 1906	66	67	270-271
Empire of the Overmind	69	68-70	272-273
Enchanter	71	72-73	274-275
Escape from Rungistan	74	75	276
Escape from Traam	76	77	277
Fantasyland, 2041 AD	78	78-81	none
G.F.S. Sorceress	82	83	278
Ghost Town	84	85	279
Golden Voyage	86	86-87	280
Gruds in Space	88	89-91	281
Infidel	92	92-93	282
Kabul Spy	95	94-95	283-284
Knight of Diamonds	96	96-99	none
Labyrinth of Crete	100	101-103	284-286
Legacy of Llylgamyn	104	104-107	none
Madventure	108	109-110	287
Mask of the Sun	111	112-113	288
Mission: Asteroid	114	114-115	289
Mission Impossible	116	117	290
Mummy's Curse	118	119-120	291
Mystery Fun House	121	122	292
Mystery House	123	124-125	292
Oldorf's Revenge (Wizard I)	126	127-130	293-294
Oo-Topos	131	132-135	294-295
Palace in Thunderland	136	137	296
Pirate Adventure	138	139	297
Planetfall	140	141-142	298-299
Pyramid of Doom	143	144	299
Queen of Phobos	145	146-147	300
The Quest	148	148-151	301
The Sands of Egypt	152	153	302
Savage Island Part I	154	155	303
Savage Island Part II	156	157	304
Secret Agent	158	159	304-305
Serpent's Star	160	161-162	306
Sherwood Forest	163	164	307
Softporn Adventure	165	166	308
Sorcerer	167	168-169	308-309
Starcross	170	171	310-311

Strange Odyssey	172	173	312
Suspended	174	175	313
Time Zone	176	177-206	314-319
Transylvania	207	208	319
Ultima I	209	210-211	320-321
Ultima II	212	213-215	321-323
Ultima III	216	none	323-326
Ulysses and the Golden Fleece	217	218-220	327
Voodoo Castle	221	222	328
Witness	223	224	none
Wizard and the Princess	225	226-229	329
Wizardry	230	231-235	none
Zork I	236	237-239	330-331
Zork II	240	240-241	332-333
Zork III	242	242-244	334-335

Game Versions Available	336-329
Vendors	341

PREFACE

The world of adventure awaits you within these covers. The solutions to these adventure games were obtained through many hours of enjoyable, often frustrating, and sometimes tedious labor. Because the games' creators provided neither the adventure maps nor the puzzle answers, this book remains subject to variable solutions as well as human error.

The purpose in *The Book of Adventure Games* is to make the games described more fun to play by helping you to overcome frustration points—not to lay out the solutions, which would lessen the enjoyment of discovery. I have made every effort to insure the accuracy of the maps and solutions contained in the book. In all cases, I played through the Apple II version at least twice to verify the specific solutions and their correct syntax. Spot checks on game versions for other microcomputers augment vendor statements that the versions for other microcomputers indeed match the Apple II version.

Nevertheless, because of the involved nature of many of these games and the possibility of minor variations between versions for different machines, neither the author nor the publisher can assume responsibility for the infallibility of these maps and solutions. While a solution as presented has solved a game, alternative approaches may open a new location (although that room would have no bearing on the ultimate solution). Similarly, I made no attempt to detail the many nuances and alternate computer responses that make these games so much fun to play. To do so would require several volumes and materially detract from the enjoyment inherent in these games. Enjoyment, after all, is the real name of the game.

— K.R.S.

INTRODUCTION

“You are standing at the end of a road before a small brick building.” So begins what has perhaps caused a revolution in the home computer field—the adventure game!

In its simplest form, an adventure game is one in which the computer provides an alter ego for you, the game player. You can sit back and fantasize about danger and deeds of great daring while the alter ego takes the risks and the bruising beatings. The challenge usually involves solving many puzzles in pursuit of the final reward.

The popularity of adventure games stems largely from their providing each player with something a little different. Some enjoy the pure escapism from dirty realities. Others are drawn by the mental challenge and stimulation attendant upon their play. Some simply take pleasure in overcoming a particular hurdle, while others enjoy the mapping of a game and finding a logical presentation for the map—quite often no mean feat. The search for surprises and a little humor in unexpected places make up another key factor, as do the side issues and involvement within a game.

Unfortunately, beginning adventurers may throw in the towel on their first game, due perhaps to a frustrating puzzle, poor vocabulary in the game, or having chosen too difficult a game to start on. Others may find that they can't seem to start “thinking” like the game's author, but are intrigued by what they see. Still others wonder what all the hullabaloo is about. This book is intended for all of these players, as well as for adventurers of all skill levels looking for that specific answer to speed them on their way to finding the surprise, humor, challenge, and delight in these games.

Puzzles present situations in which you have to figure out what action you need to take in order to proceed to the next part of the game. You may have to choose a direction, manipulate some object on the screen, or even figure out how to slay a dragon! You will need to determine which objects—treasures, devices, etc—you should acquire and carry with you, and which to leave behind or store until later, a process commonly referred to as “inventory management.” Maps show the layout of the game; they should give a plan view of all the game's locations. Sometimes you will encounter a maze, where many identical or nearly identical locations seem to exist.

You will discover that when trying to solve a puzzle you sometimes use words rejected by the game because the vocabulary of every game is unique and often limited. You will also learn the syntax, or command parser, acceptable to each game. You may have to type in two-word only commands or commands which require that you type a verb first and then a noun: e.g., GET CHEST. In general, the more synonyms allowed and the more flexible the command parser, the better the game. The popularity of an adventure game increases in proportion to its sophistication.

CATEGORIES OF ADVENTURES

Adventure games may be broadly separated into two categories, puzzle adventures and fantasy adventures. Either may be further divided into all-text adventures or games making use of the computer's high resolution (Hi-Res) graphics capabilities. The obvious visual difference between the two lies in the display, either a neatly formatted text page, or a display dominated by a graphics scene with but a few words of text.

Of the major categories, puzzle games emphasize logical solutions and demand mental agility, ranging from pure guesswork to inductive and deductive reasoning. They usually present a mission or objective, be it rescuing the fair maiden, ridding the kingdom of an evil force or creature, or recovering a long lost treasure. Quite often, the objective doesn't become clear until well into the game. You encounter obstacles to progress in the form of puzzles which you must resolve before you can realize the objective. You must find and use a multitude of objects in various locations or use them on other objects to achieve a desired result. The games can often, therefore, become the source of considerable frustration when the proper answer eludes you. Some of the pleasure of these games derives from succeeding after repeated failure.

Fantasies, on the other hand, generally have a clearly defined objective at the outset, fewer or much simpler puzzles, and usually trade off frustration against sheer determination. Fantasy games generally are less "real." The player often assumes the identity of a character, such as an Elf, Gnome, or Dwarf, which may further break down to Fighter, Wizard, Mage, or Priest, to name but a few. Fantasies invariably require a multitude of battles with various and sundry monsters. Here, frustration can arise, as initially your fledgling character may have trouble surviving long in the world of beasties. To survive, your character must defeat enough innocent monsters to gain experience and gold, the elements necessary to build him or her to a state of near invincibility where he or she functions efficiently and can attain the ultimate goal.

HISTORY OF ADVENTURES

Once upon a time (isn't that the way all good literature starts?), when 16K computers were still the size of a house, there were adventure games. Even in the 1960s, large and complex games such as *Life* and the original *Adventure* appeared on these mainframes long before the advent of home computers. The people using these computers employed their imaginations during their spare time searching for new ways to play with a new "toy."

Thus, adventures evolved essentially parallel to the computers themselves. But when the home computer first came out, the games initially available were fantasies. *Super Dungeon* and *Dungeon Campaign*, for example, required your carefully tailored alter ego to march around in a multi-level dungeon seeking various treasures, and encountering and whomping monsters before they whomped you. One of these, *Beneath Apple Manor*, published in 1979, became one of the first fantasy classics.

Early adventure history was made when the first of Scott Adams' all-text adventures appeared in late 1979 and the early 1980s. Initially available only on cassette, these relatively compact games consisted of some thirty-five or so rooms, and were among the first programs written in Assembly language. This speeds a game considerably, which adds immeasurably to its continuity and playability. As programming sophistication increased, these popular games were transformed into Hi-Res versions; but in the case of puzzle games, whether or not this is a true upgrading still sparks debate.

At about the same time, in early 1980, *Adventure* (sometimes referred to as the *Colossal Cave*), which begins "You are standing at the end of a road," was translated into BASIC language for the Apple computer. This was a major accomplishment considering the size and complexity of the programs being mashed into Applesoft. At least five different companies have put out a version of this game, including faster playing Assembly language versions. Although nearly identical, Microsoft's version adds an interesting twist with an additional room, the "Software Den," and a two scenario save-game capability.

Roberta Williams “took a small step for man and a large step for adventurers” with the release of the first Hi-Res adventure, *Mystery House*, late in 1981. Colorful pictures replaced much of the text, leaving only a few necessary words in the bottom four lines of the screen display. Some soothsayers stated that this game would sound the death knell of the all-text games, and indeed such graphics games have become immensely popular. However, as to ending the reign of all-text games, such predictions were considerably premature.

Many players prefer a good all-text game to even the best Hi-Res game. They like the imagination required to visualize the surroundings and elements of the puzzles. Often an image appears in your mind’s eye that no on-screen graphic can match for vividness and pleasure. Some all-text games provide screens of text that rival real literature in terms of their use of allegories and descriptions, even purple prose which can boggle the imagination. On the other hand, if you simply read that you are in a cave-pocked hillside, would you immediately respond “Go Cave” as you would if you saw some caves staring you in the face?

Infocom has perhaps done the most to keep the all-text adventures alive and thriving with two significant breakthroughs. The command parser originally developed for *Zork*, which was released in 1981 on the Apple (another game originally written on a large computer and subsequently converted), permits the use of conversational English. You can enter complex commands (complete with adjectives and adverbs) rather than two-word-only commands such as “Go Cave.” Tables of equivalencies and synonyms added tremendously to the playability of these games, removing much of the unnecessary “puzzle” of having to guess the exact word to use in order to accomplish a specific task.

Deadline, published in 1982, provided the second breakthrough by permitting the independent actions of characters within the game; you could interrupt the actions of characters to ask questions and to alter their future course of action. This game also used a feature first seen in Scott Adams’ *The Count*: objects and descriptions of locations could change as the days or hours progressed, with new objects appearing in old locations. Since then, independence of action and change over “time” have evolved even further. In *Labyrinth of Crete*, the two alter ego characters, Jason and Hercules, can receive separate commands and behave cooperatively. The same holds true for the six independent robots of *Suspended*, another Infocom game. Any one of the characters, once given a command, will dutifully carry it out in the background, reporting back to you upon the completion of its assignment while you manipulate other robots in the foreground on separate tasks.

An equally noteworthy breakthrough in fantasy games became visually apparent in *Ultima*, wherein your character roams over a landscape considerably larger than the immediate area of the visible screen. As you move “off the edge,” new graphics smoothly scroll onto the screen, giving the player a feeling of great scope and expansiveness.

As the games evolve, the distinction between the two general types blurs. For example, the fantasy games *Ultima III* and *Legacy of Lylgamyn* (1983) both include numerous puzzles, such as riddles or extensive searching requirements, to find objects. Nevertheless, the primary emphasis remains monster whomping, searching, and exploration. While Hi-Res graphics have become a large part of the puzzle-type adventure, a graphics *tour de force* such as *Ultima* or *Wizardry* still commands an enthusiastic following.

Today’s adventures, always searching for something new, employ a better usage of sound, animation, Real-time response requirements, and arcade game tasks (e.g., skiing between trees in order to proceed on to the next puzzle element). Some include major arcade game tasks between elements of a puzzle adventure. What will appear in tomorrow’s adventure is anyone’s guess. Like the games themselves, the answer lies only in the imagination of the programmer of that yet unwritten game. As the games’ sophistication increases, so too will their popularity, as these two factors are synergistically related, each providing fuel for the other’s growth.

WHAT MAKES A GOOD ADVENTURE?

Beauty is in the eye of the beholder. Just what sets a good game apart depends on each player. While my personal favorites are the original *Adventure* and the *Zork* series, I didn't know that until I had finished playing them. Unfortunately, you cannot tell how well you like something until you've tried it, particularly since most adventure games are packaged with snazzy covers that have little or no bearing on the game inside.

Regardless of which game you consider your favorite, you should consider the following types of questions to determine the relative quality of any given game:

Are the puzzles imaginative and logical, or old hat? Are they simply souped-up guessing games?

Are there alternative approaches or more than one area to work on at a time, or must you solve one specific puzzle before approaching the next? Such in-series-only puzzle games usually offer little inspiration, only a maximum of frustration.

Is the text bright, descriptive, and well-written, or sparse and matter-of-fact, without anything to stimulate the imagination? Elements of humor and side issues, while they may have no direct bearing on the game, materially enhance the game and make it enjoyable.

Have you ever taken out your frustrations on the game and sworn at it or given an obscene command? Try it, you might be pleasantly surprised—and it gives you a rather strange feeling to apologize to a computer.

It won't take too long to find out about the command parser. Will it accept only two words or an entire sentence of multiple commands? Do you have to use a specific word to get a response? A good game will have good vocabulary and a reasonable number of equivalent nouns and verbs. Nothing is more frustrating than using words like "open," "unlock," "break," "move," "lift," "shake," "twist," and "unwrap" only to find that "use" is the only correct word.

Take a look at your map. Is it logically laid out? Do the mazes have a reason for existence, or are they pointless? Are there too many mazes for the size and complexity of the game? Are there many pointless one-way moves?

Does the game get you killed off unnecessarily without even a chance to defend yourself or escape? How do you get killed? Was it clever and quick, or was it unnecessarily sick and graphically gruesome? Did you learn from it?

Does the "save game" feature permit you to save a game at any time, or only when you quit? When you re-enter a game, is that the only time you can use a saved game? Must you endure a long boot-up cycle to reload the entire game just to load a saved position? Will the game support two drives, eliminating unnecessary disk changes?

What of the game's speed? How fast does it play? Slow color fills and a lot of disk interaction detract from the game's continuity and playability.

Does your Hi-Res game permit you to look at the last sequence of text you entered, or even to play the game as an all-text adventure?

Finally, when you have finished the game, are you sorry it's over, or simply relieved?

Another way of getting an idea about the quality of an adventure game is to check the ratings in *The Book of Apple Software*. For now, why not grab an adventure that's fun, but has been giving you problems, and take another whack at it?

HOW TO TACKLE AN ADVENTURE GAME

Each game has its own flavor and idiosyncrasies. To be successful, the player must try to think the way the author did when writing the game. When starting a game for the first time, try beating around it for a while, without even trying to map it or solve any puzzles. Simply try to get the feeling of the game. Pick up anything you can, and try to do something—anything—to or with it. Next, start over and map as much of it as you can, without trying to solve anything. Don't even "touch" anything just now—be patient. Annotate your map with the objects you find and any clues, like signs that you can read or things you shouldn't do (for example, try not to get killed the same way twice).

At this point, you're finally ready to play the game for real. Look at your map, as much of it as you have so far. What can be pieced together? Where did you get blocked or clobbered, and why? Use what you've got and try to develop something, anything. Many times, the initial puzzle isn't too tough (*Savage Island Part II* being an exception). As soon as you make a breakthrough, save the game and push your map forward, if possible. Try to anticipate where the puzzles occur and what you might need to solve them, then go look for those items.

Mapping the Game

Mapping a game is a necessary element in adventure play. Mapping refers to making a road map to tell where you are, where you've been, and how to get back to a given location. More importantly, you should annotate the map with what you find, how it's used (once you find out), and, later, the key words to the solution of the puzzle at any given point. One of the best games for beginners is *Birth of the Phoenix*, which includes one of the best tutorial manuals on mapping and a beginner's approach to adventures. The game itself, as you'd suspect, isn't difficult; but it contains examples of all the aspects common to most adventure games.

Start your map with a rectangle to represent the location at which you first find yourself. Methodically go North, then back (hopefully) South, drawing as you go. Bear in mind that leaving a room to the North does not mean that you necessarily enter the next room from the South. Concentrate on "finishing" all possible directions for that initial location. Remember that some games have ten possible directions out of any location: the four cardinal headings; NE, NW, SE, SW; and up and down. Some games tell you possible exits—just don't always believe them; draw in a short straight line to mark those directions.

Develop your own shorthand. If you can't go in a particular direction, put an "x" there; if you can't return to the start by reversing direction, put a one-way arrow on the last line. You can simplify the map later when and if you find two lines with arrows between two locations. Should a scene seem repetitious, make sure that you are not in a loop. Drop an object and keep going. If you come across the object again, obviously you've looped back.

If you find yourself in a maze, be it an open ocean, underground, or a field, use the same technique as you did to find "loops." Develop your maze on a separate sheet of paper. Drop an object and name your present location (the rectangle) with the name of the object. Move somewhere, drop another object, and name that location with the name of the newly dropped object. Draw an arrow from the first object in the direction that you moved and name it as the second object. Continue moving and dropping objects, and soon you'll find yourself in familiar locations.

When you've finished, you'll have a number of rectangles equal to the number of locations in the maze, plus arrows pointing from one location to another, showing directions. You can redraw the maze now, using the named locations as the basis for your map.

Some mazes are tougher to map. Creatures may come along and pick up what you've dropped, or your object may sink into the mud and disappear forever. Some mazes (like the ones in *The Mask of the Sun*) don't show your object (even though it's really there) unless you "LOOK." Other mazes have a lot of one-way trips; that is, once you reach a second location, you cannot to return to the first one.

Inventory Management

In many games, inventory management proves a problem. You may find more objects to carry than you can handle at any one time. Occasionally, you can obtain minor relief by putting smaller objects into larger ones. The problem may be compounded by the multiplicity of objects often encountered early in the game, before you have determined their relative uses. A second complication arises because some objects have several uses in widely separated locations. You have to figure out what to carry, where, and when.

Two suggestions for inventory management are: first, avoid picking up treasures until you are heading back to the storage area. Take them back in bunches. In some games, such as *Kabul Spy*, treasures are secondary to the real object of the game (but do add to the score); they are seemingly there primarily to reduce your ability to carry objects you really need.

Second, establish a centrally located depository, sort of a temporary treasure storage area. Don't leave objects lying all over the place, as you may have a miserable time finding them again. As the game develops and you probe deeper, bring your objects closer to your "working area" and establish a new temporary depository.

Be patient, you may be only a few keystrokes away from success. When you really get stuck, marshal all your objects and forces at that point, and dig in. Keep a dictionary and thesaurus near at hand. Quite often, having two people tackle one game will produce faster results. What one misses may be intuitively obvious to the other. When all else fails, look in *The Book of Adventure Games*.

USING THIS BOOK

This book contains the maps for over seventy of the most popular electronic adventure games. The purpose of the book is to make these adventures more enjoyable and less frustrating, but not less challenging. Thus, even though explicit solutions to the games appear in the back of the book, *please* don't take the coward's way out. Looking up the answers before you try to solve the game on your own could ruin the game for you.

Use the maps as you play, and if you really get stuck, look for a number by that location. In the back of the book you can find corresponding numbers with solutions for that particular problem. Use these solutions only when you have been stumped for some time. This book is designed to help you find just the hint you need to keep playing, without giving away the whole game.

Don't worry if the maps show locations that you have not yet found. You may have to solve certain puzzles to uncover particular locations. These objects may not be visible or accessible on your initial visit to the location.

This book won't tell you everything. The maps don't specify, for example, when or if you should take an object. They don't help you with inventory management. You will have to read the signs and plaques, examine and consider the objects and locations, and, most importantly, use your imagination. These side issues provide much of the fun of the game.

THE GAMES

ADVENTURE

Company: Several

Suggested Retail: \$29.95

Type: The original all-text adventure—a classic.

Description:

The first message in *Adventure* consists of the words known to all adventurers: “You are standing at the end of a road before a small brick building.” The last message describes your being borne off on the shoulders of elves. Between those two lie 130 rooms, fifteen treasures, some forty objects, and a variety of cave inhabitants for you to deal with and outsmart.

Playability:

If this is your first adventure, you’ve picked the one that hooked me! The story flows well, and the text reads like a novel in its expansiveness and descriptions. Most versions are disk interactive and a little slow, except for the Scott Adams version in Assembly language. The Microsoft version, perhaps the most faithful, has two saved-game positions and adds a room, the Software Den, with its own special twist.

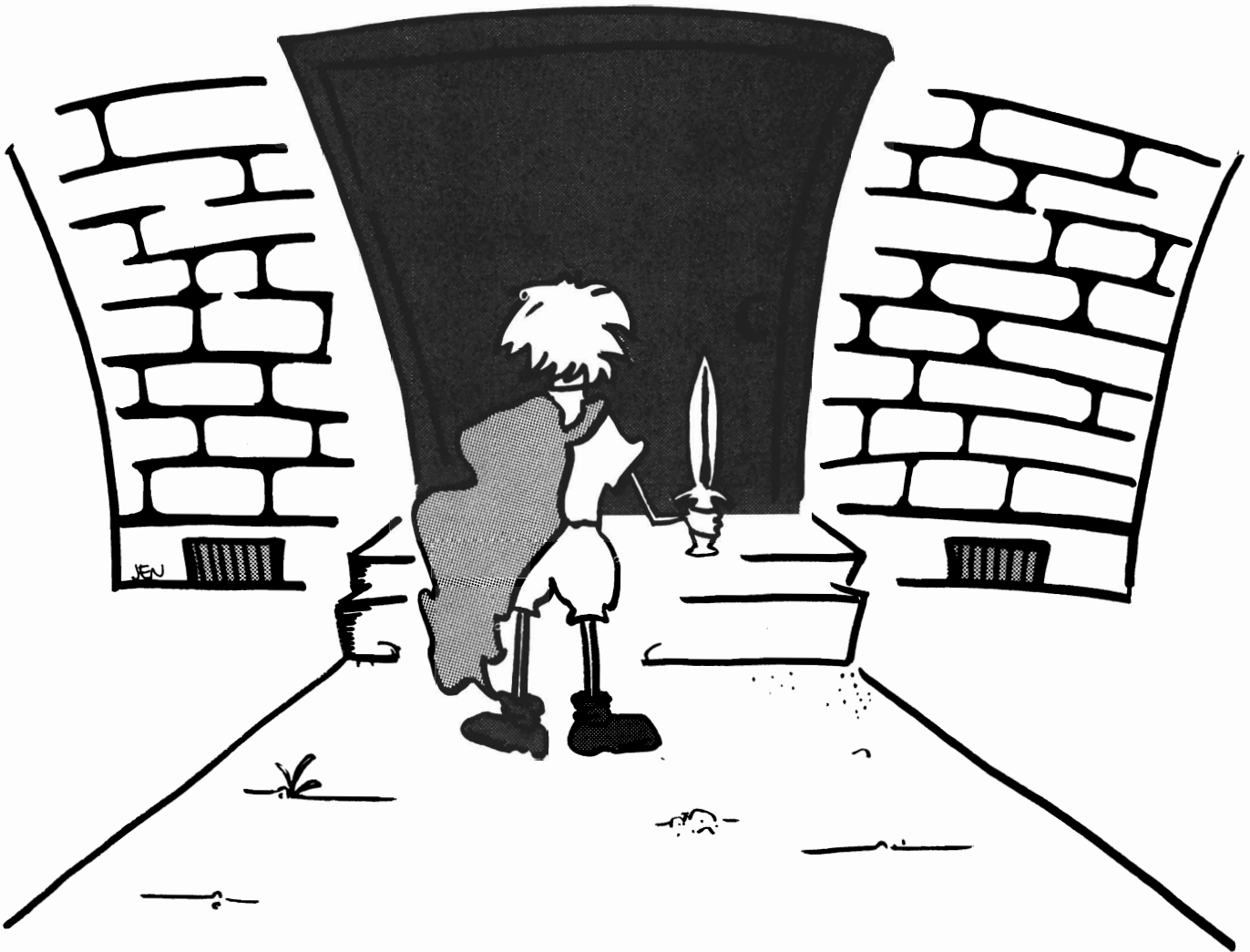

ADVENTURE

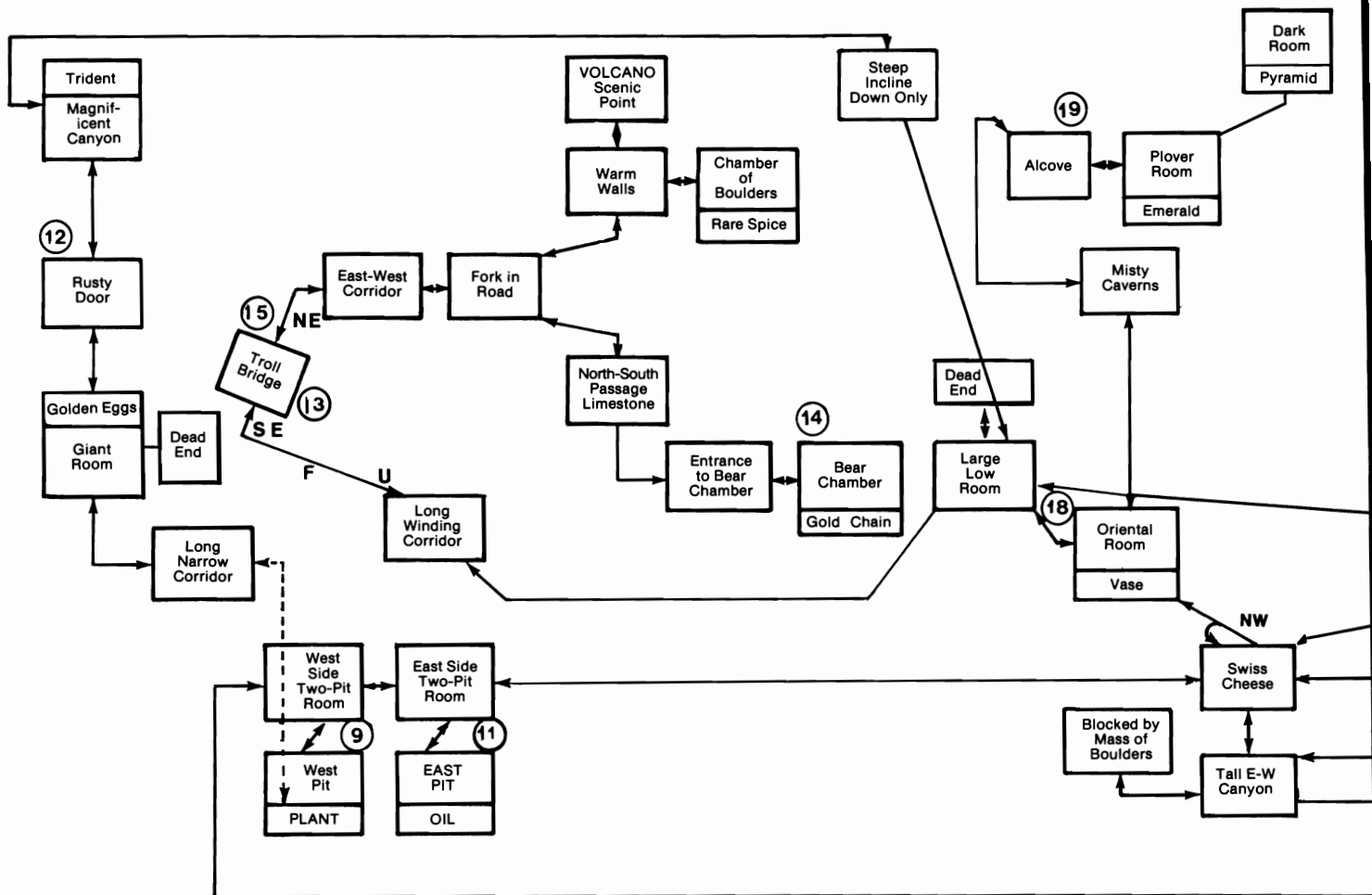

The Repository (End Game)

NORTHEAST
 End of Repository
 Bottles/Beanstalks/
 Oysters/Rods w/star
 Lanterns/Dwarves
 Mirror

(23) SOUTHWEST
 End of Repository
 Snakes/Cages/Birds
 Rods w/marks
 Pillows/steel Grate
 Grate is locked
 Sign

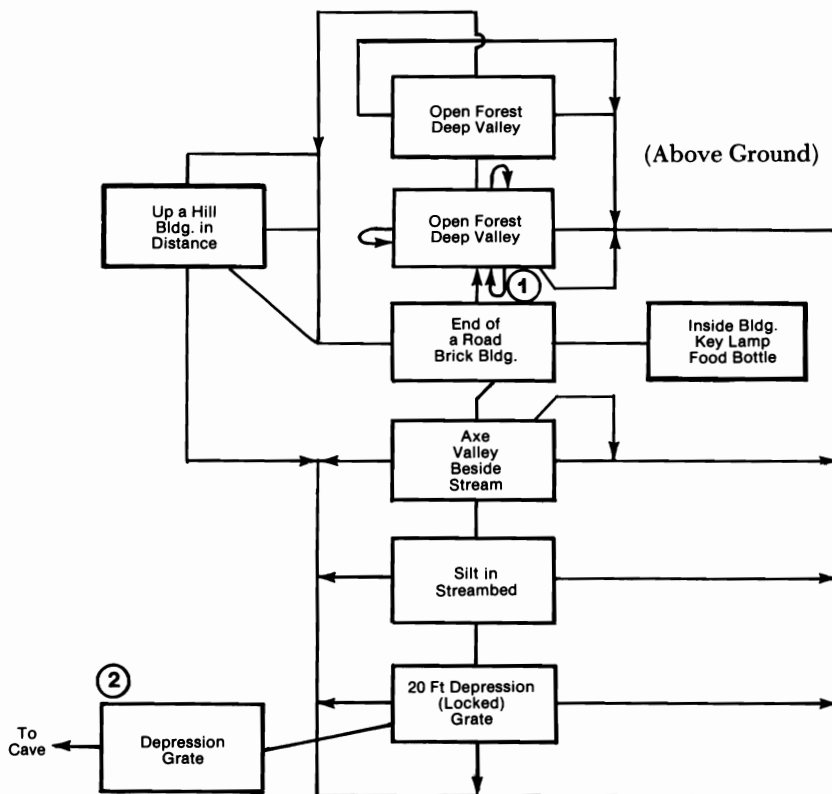

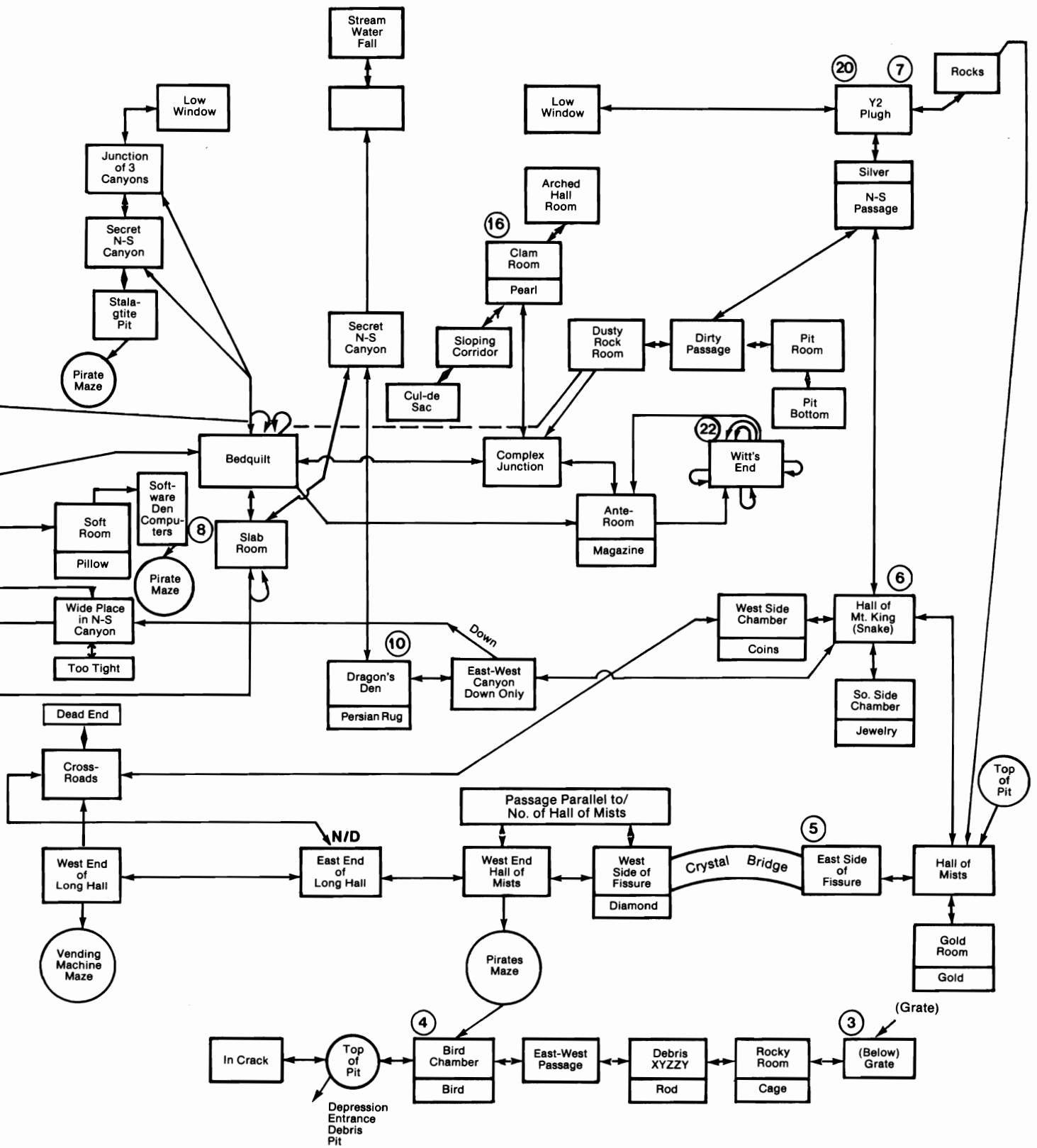

ADVENTURE

Vending Machine Maze

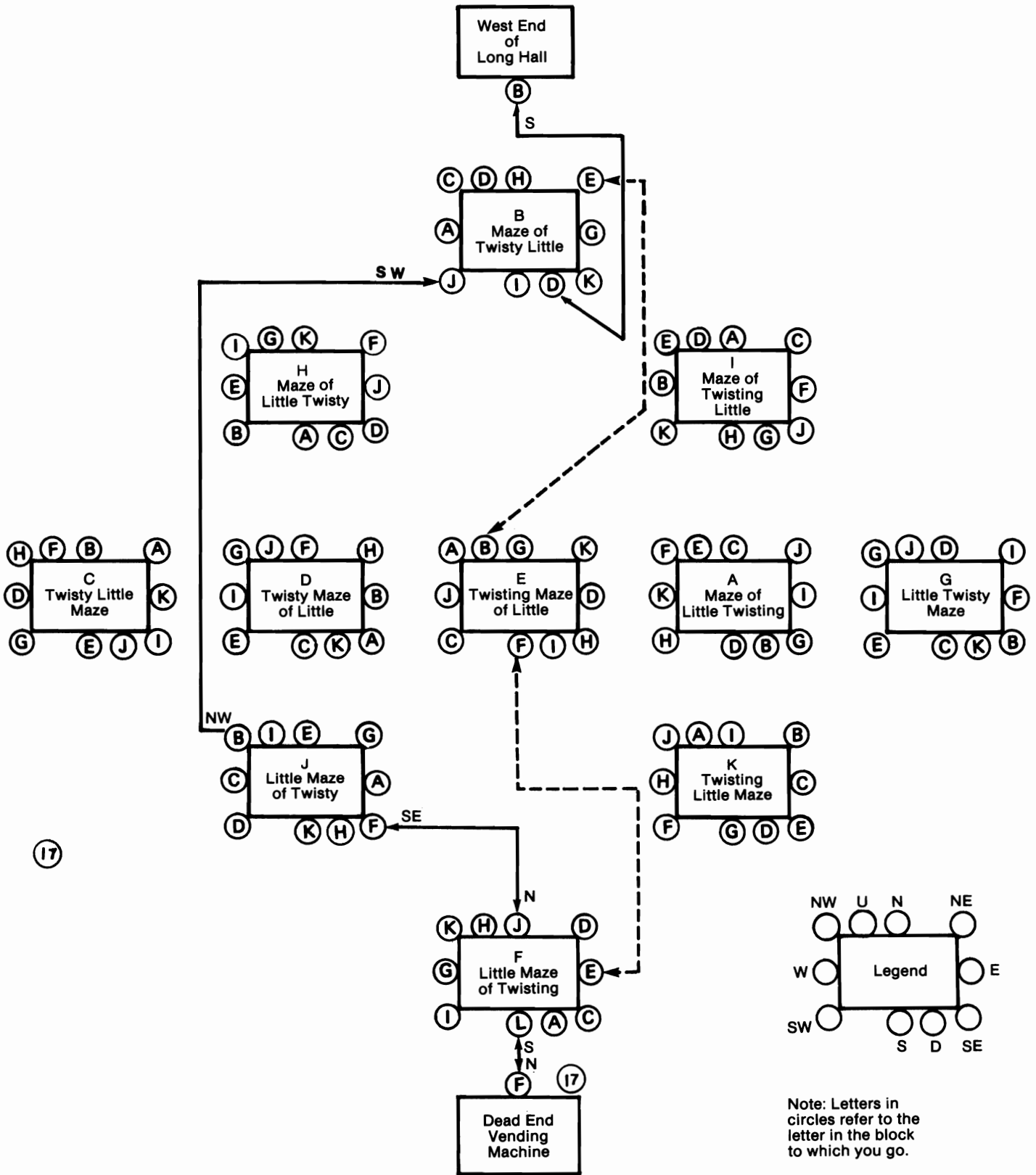

ADVENTURE

Pirate's Maze

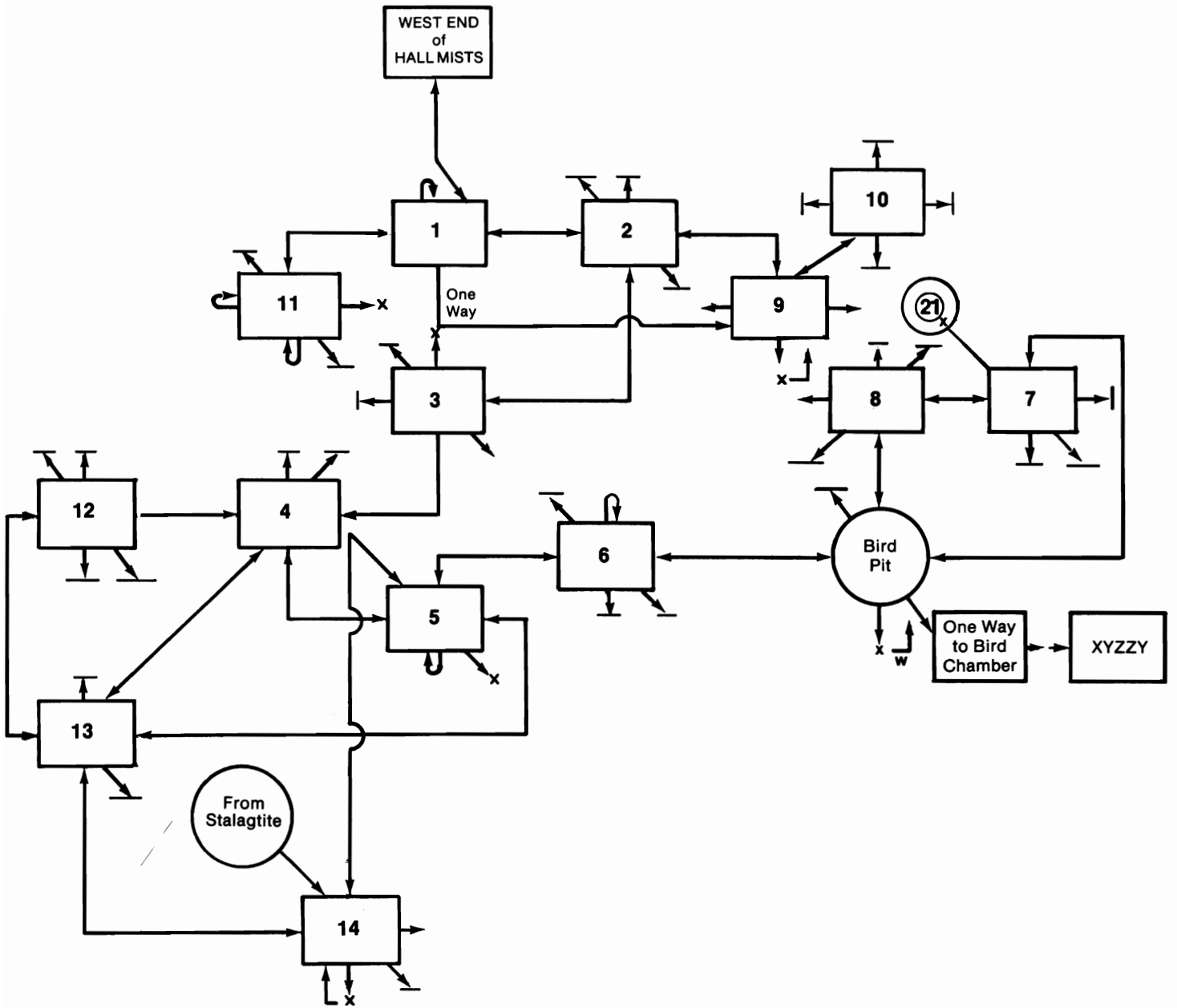

ADVENTURELAND

Company: Adventure International

Suggested Retail: \$39.95

Type: Originally an all-text game, recently re-released in Hi-Res form.

Description:

This game has the distinction of being the first of the good puzzle games. Thirteen treasures lie above and below ground in this adventure. Some treasures just lie around for the taking, but others will take a bit of head scratching before you finally glom onto them. In the process, you have to contend with Bees, Bears, Lava, Insects and a Sleeping Dragon.

Playability:

Overall, the puzzles are not too difficult, and the game provides a good introduction to the tougher games in the Adams series. The two-word syntax has a limited but adequate vocabulary. The text is brief and to the point. The game offers a single, easily made or recalled saved-game.

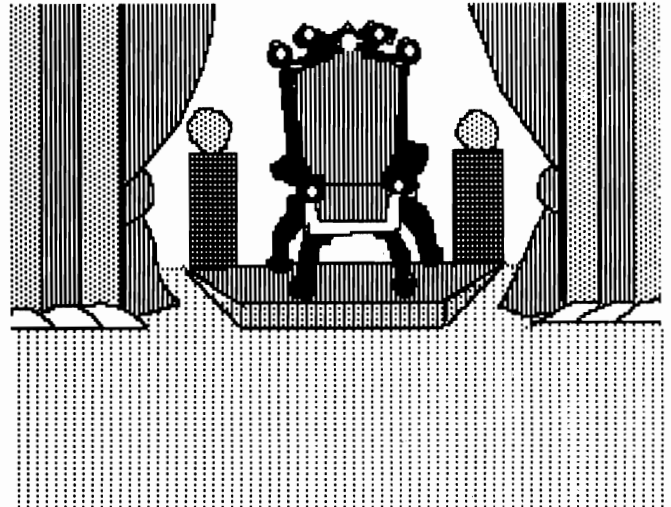

ADVENTURELAND

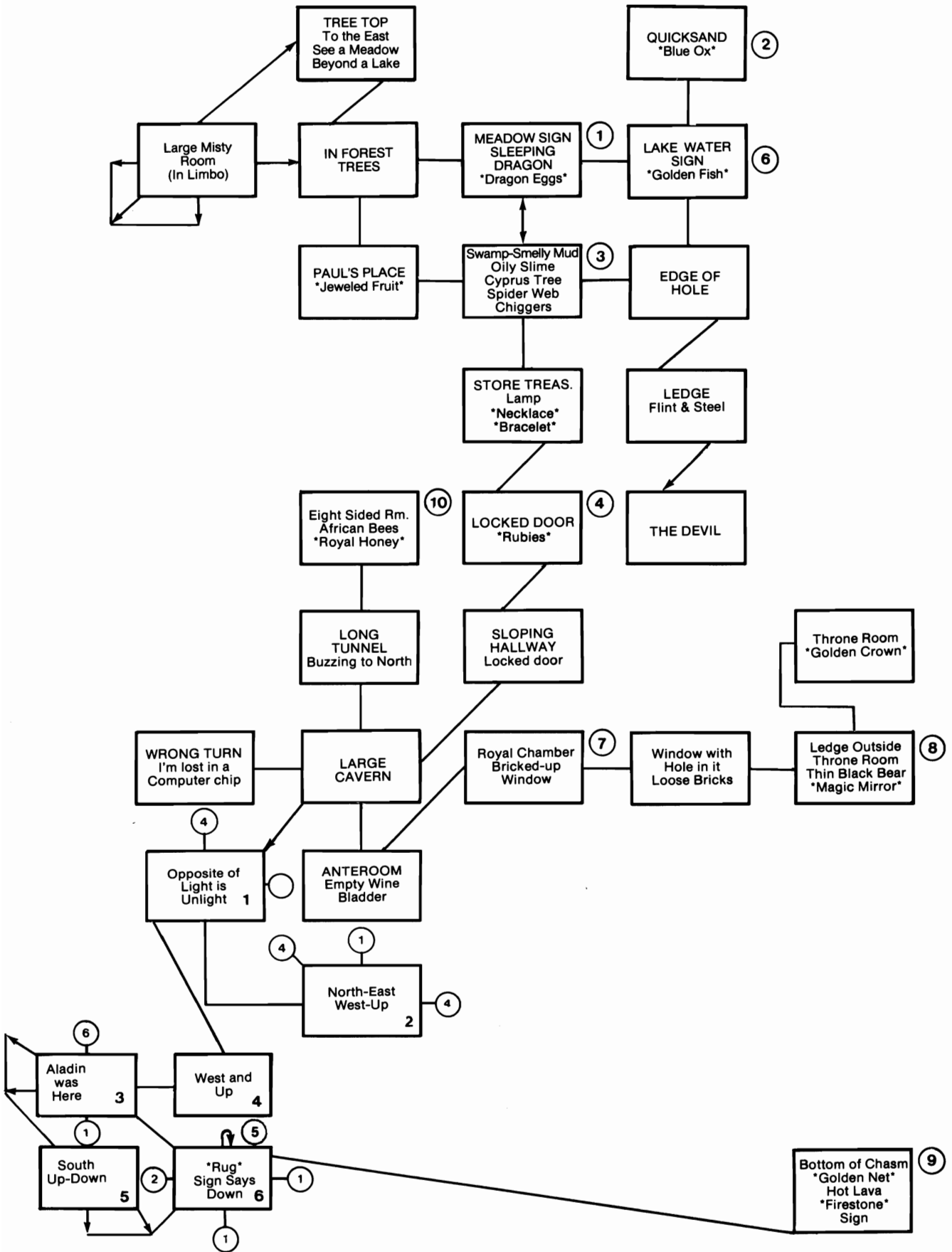

ADVENTURE IN TIME

Company: Phoenix Software

Suggested Retail: \$29.95

Type: An all-text adventure.

Description:

You must locate the bad guy, Nostradamus, who lurks somewhere in time, and kill him before he can assemble the ultimate weapon and destroy the world. You may travel to four different locations in time and to an interesting lab which even has its own computer. A friendly robot helps you out.

Playability:

This game's traps and puzzles will keep an experienced player busy for several hours. Although rated for experienced players, it is by no means too difficult for beginners. The crisp, quick response, tongue-in-cheek style, and save option further add to the game's appeal.



ADVENTURE IN TIME

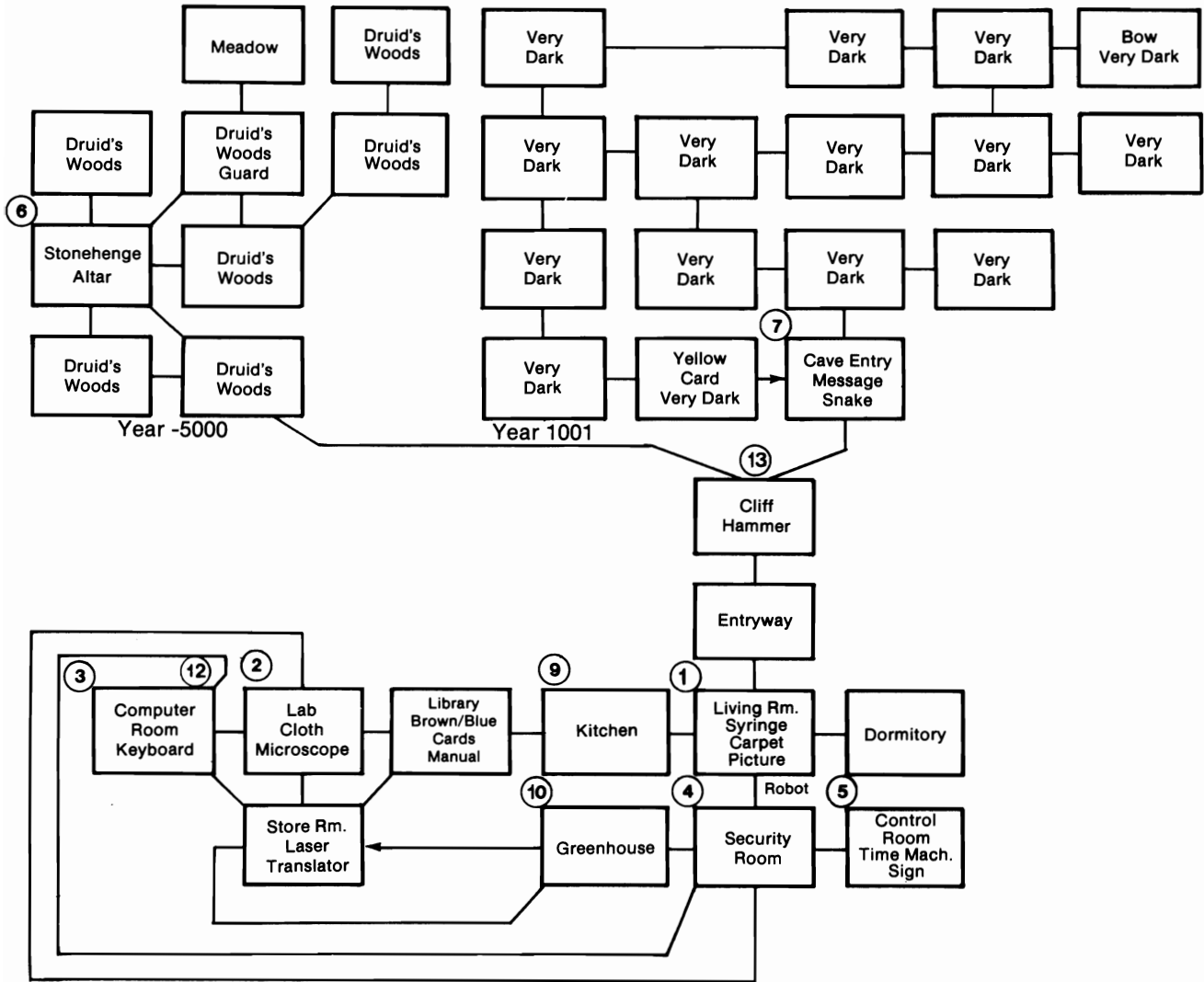

ADVENTURE IN TIME

Part 2

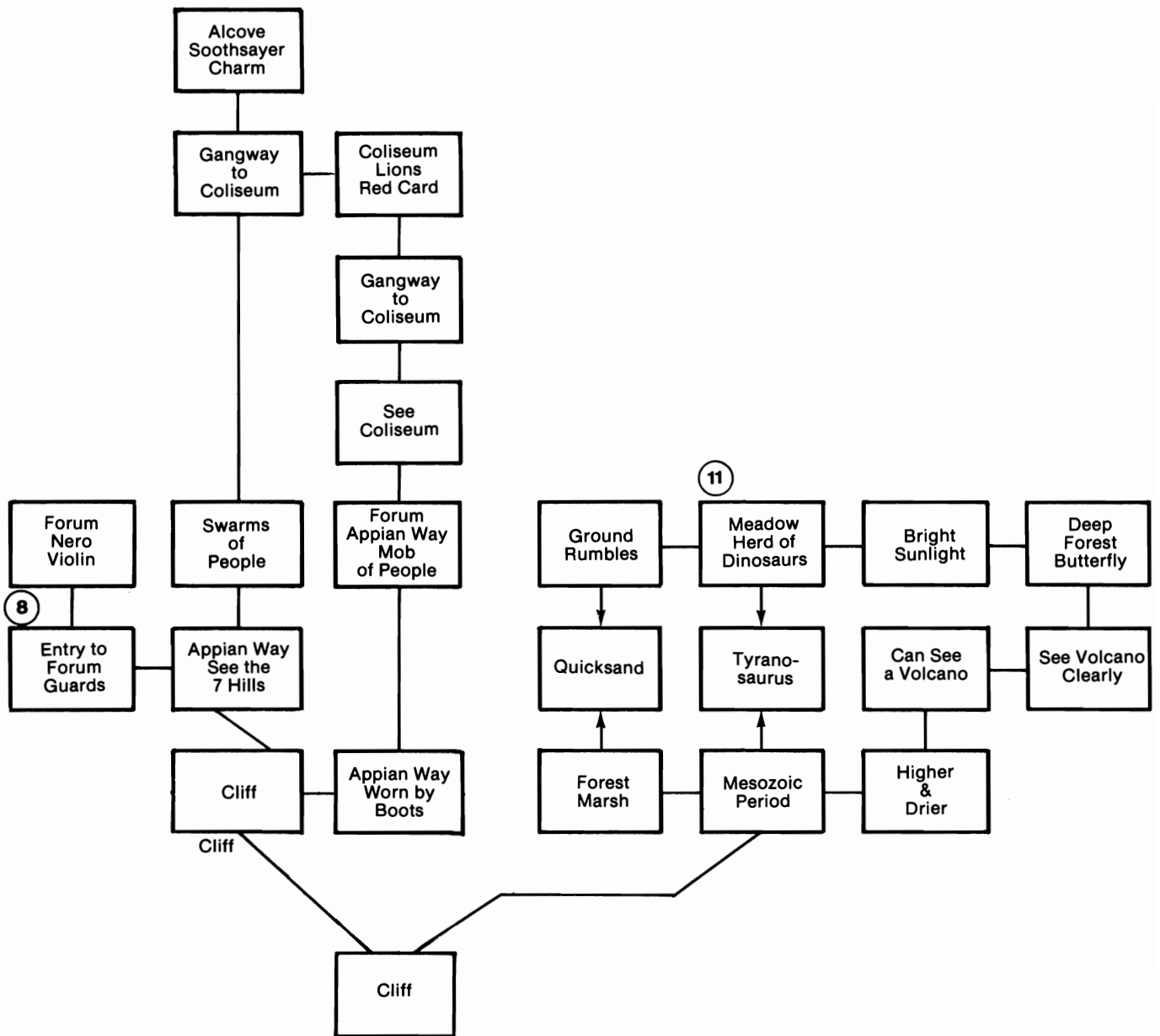

ALI-BABA AND THE 40 THIEVES

Company: Quality Software

Suggested Retail: \$32.95

Type: Originally the all-text game called *Fracus*, this fantasy has colorful Hi-Res graphics and sound and has undergone extensive modification.

Description:









This light-hearted combat game takes place in a medieval setting. You beat up monsters, find treasure to buy more effective weapons and armor, and ultimately rescue the Princess Buddir. You face an endless procession of assault-minded thieves and assorted monsters. However, you do have a host of allies on your side, and sometimes the indiscriminate baddies even clobber each other. You can just sit back and watch, and often listen to lots of music.

Playability:

No single solution to this fantasy adventure exists, so none is provided beyond the map. One or more players can play with paddles or keyboard. I suggest annotating your map as a means of keeping tabs on the many hidden doors, chutes, and strange goings-on.



ALI-BABA AND THE 40 THIEVES

-  Open Door
-  Closed Door
-  One Way Door
-  One Way Door
-  (Open doors may close at random times)
'Rune' - a message
-  Treasure
-  Store - sells weapons or armor
-  Illusions of doors

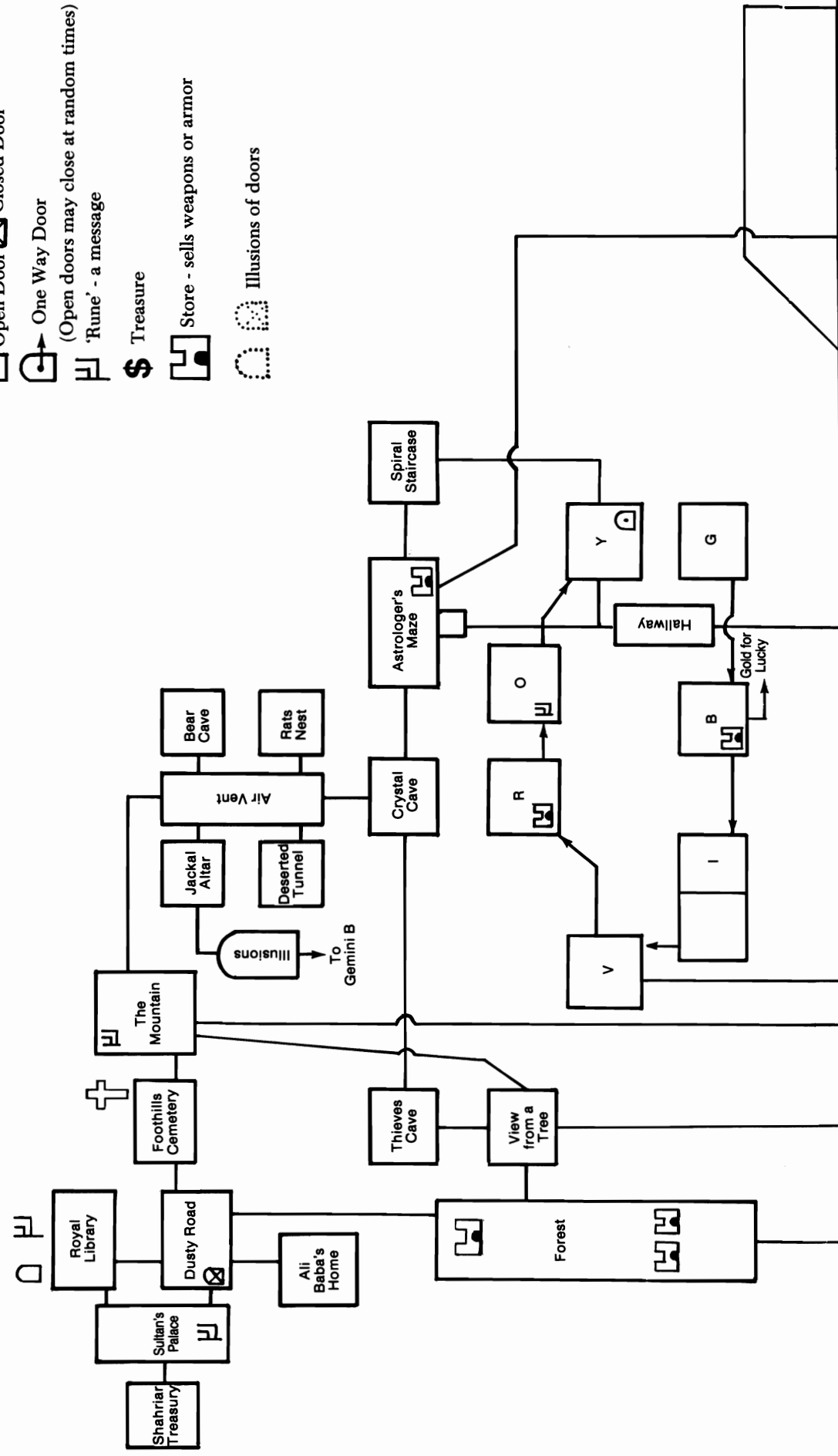

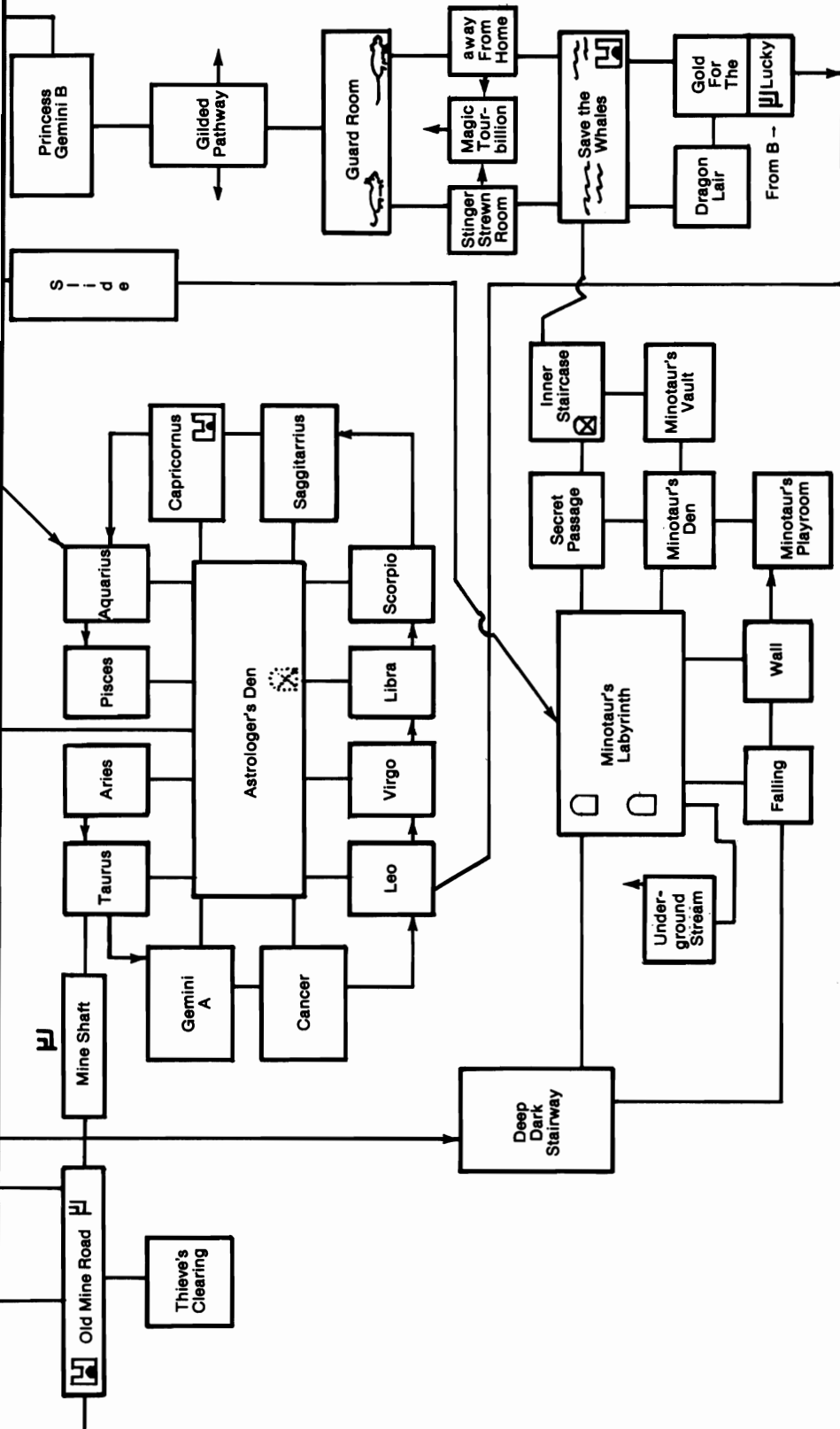

BENEATH APPLE MANOR

Company: Quality Software

Suggested Retail: \$29.95

Type: Originally a Lo-Res game, recently re-released in Hi-Res form.

Description:

In *Beneath Apple Manor*, a classic fantasy game, you try to find a Golden Apple hidden deep within a multi-leveled, maze-like basement. You need no hints or clues to solve this game, only a bit of patience. Different types of monsters abound, and the deeper you go the tougher they become. Magic items found on most levels may help you in the quest.

Playability:

The new version provides a Hi-Res display of up to five rooms, while a pleasantly familiar Lo-Res (text page) display of the original version is available for games of up to ten rooms and at any of the ten degrees of difficulty. Elements of strategy enhance the game, but no puzzles impede your progress. No single solution exists, so none is provided. Because the maze of each room is random, only a typical floor map, dumped from the screen, appears.

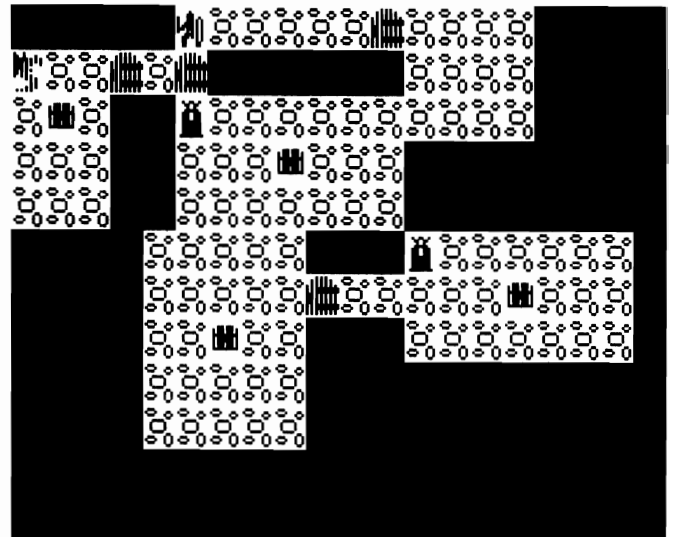
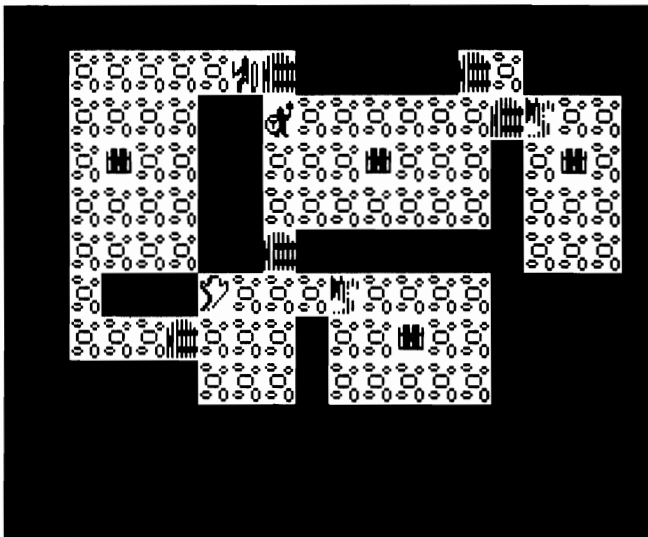

BIRTH OF THE PHOENIX

Company: Phoenix Software

Suggested Retail: \$14.95

Type: An all-text adventure (tutorial for adventurers).

Description:

I could have written a solution to this, but didn't—it's not difficult, and brings you along carefully. You must uncover three treasures and complete a special task as part of this game. Other features common to big time adventures are a magic word, a maze, and a relatively interactive puzzle.

Playability:

A tutorial adventure for the beginner, enjoyable and worthwhile for first-time adventurers. The excellent documentation clearly describe game elements in detail, and encompasses clues to a variety of specific adventure games.

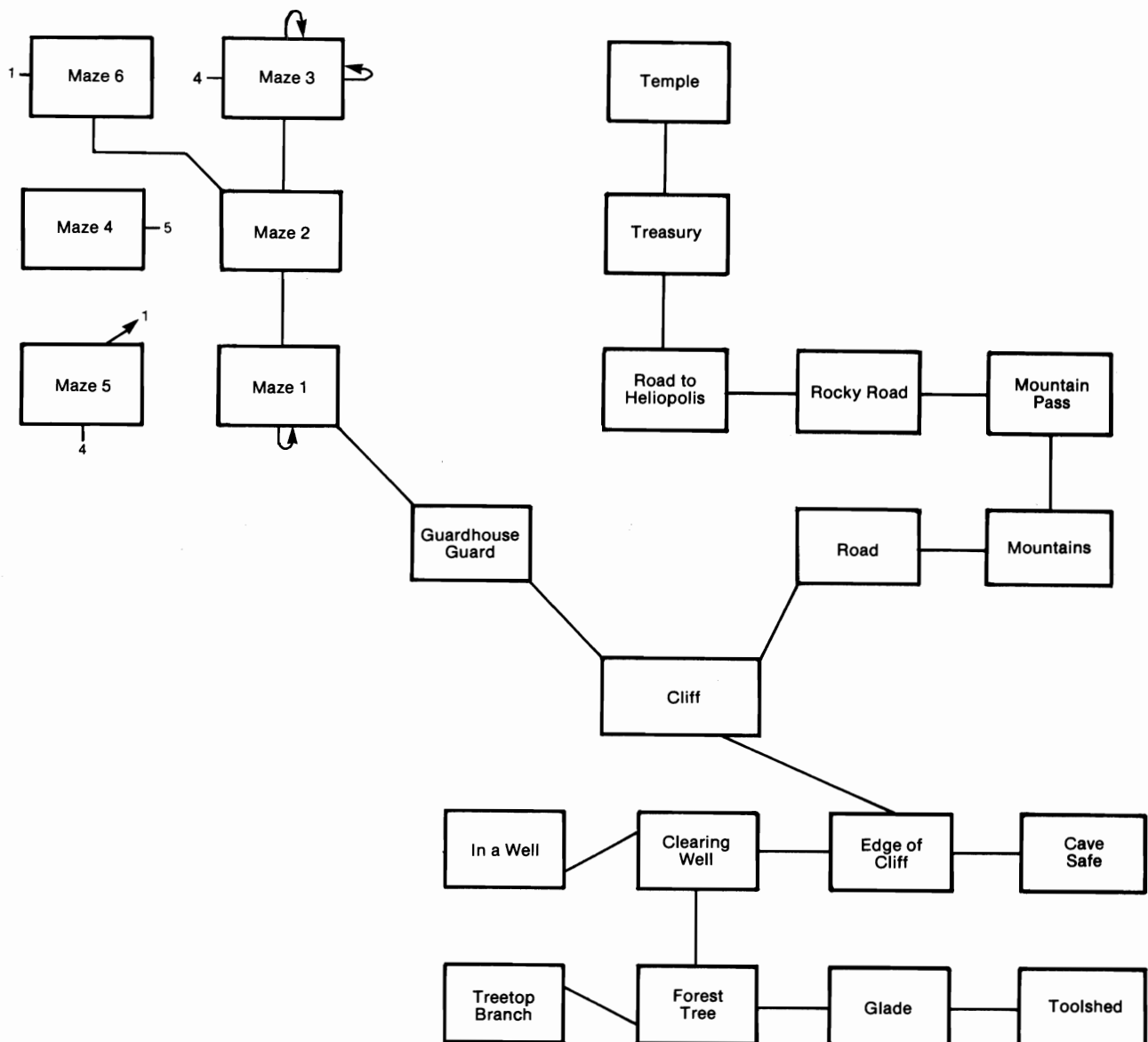

BLADE OF BLACKPOOLE

Company: Sirius

Suggested Retail: \$39.95

Type: Hi-Res adventure with color graphics and Hi-Res text.

Description:

You have to find and return the Sword of Myraglym. Standing between you and success are talking plants and idols, several riddles, a booze-happy monster, a tough-hided lizard, and a variety of ways for you to come to a premature end. Secondly, you gain 500 points for solving the puzzles; the last point is sorta tough.

Playability:

While the *Blade of Blackpoole* contains no adventuring breakthroughs, it offers pleasant enough story line and graphics. Inventory management does present some challenge, since you can carry only six of the twenty-three objects at one time. Some objects have multiple uses, but the sequence of managing them becomes more difficult because you cannot readily return to certain locations. The overall difficulty leans slightly to the tough side, ideal for average adventurers.

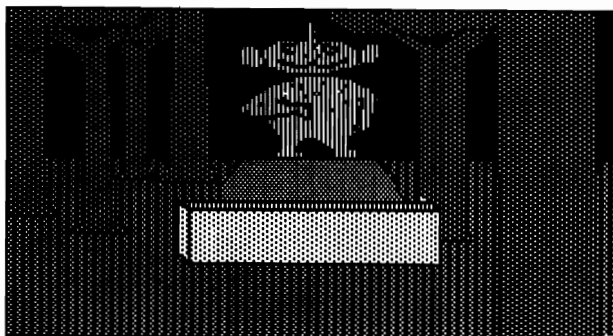

: READ BOOK

THE BOOK CONTAINS DESCRIPTIONS OF A RITUAL AND A PRAYER CALLED 'SOLOCIN'. YOU CAN'T QUITE READ THE WORDS OF THE PRAYER, BUT YOU RECOGNIZE THE WORD DANGER
:_

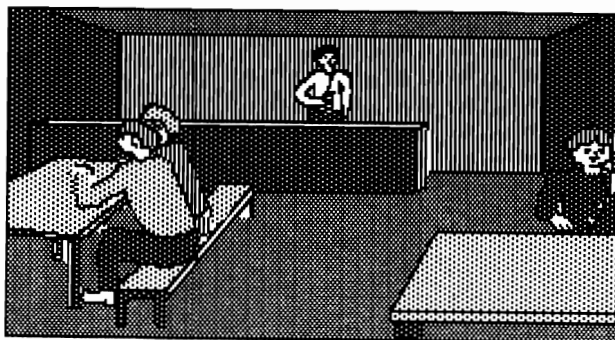

CONGRATULATIONS, YOU HAVE SUCCESSFULLY FULFILLED YOUR QUEST AND RETURNED THE SWORD MYRAGLYM TO IT'S RIGHTFUL PLACE. YOUR NAME WILL BE PROCLAIMED THROUGHOUT THE LAND FOR THIS DEED, AND THESE MEN SHALL SERVE TO BEAR WITNESS FOR YOUR HEROISM AND BRAVERY.
>MORE<

CASTLE OF DARKNESS

Company: The Logical Choice

Suggested Retail: \$34.95

Type: Hi-Res adventure with color graphics and animation.

Description:

To overcome the might of the evil wizard, Grimmacht, you must discover the power behind his curse. You explore the many rooms of two castles, some with treasures, others with monsters or clues, and many with nothing at all. When you get through them all, you will have gained 200 points and had the dubious pleasure of watching your animated character march slowly all through the palaces.

Playability:

The game offers a degree of animation and occasional spoken words, but some of the graphics leave a lot to be desired, particularly small and difficult to differentiate objects. Travel from location to location is on the slow side. Also, the limited vocabulary often makes progress frustratingly slow.

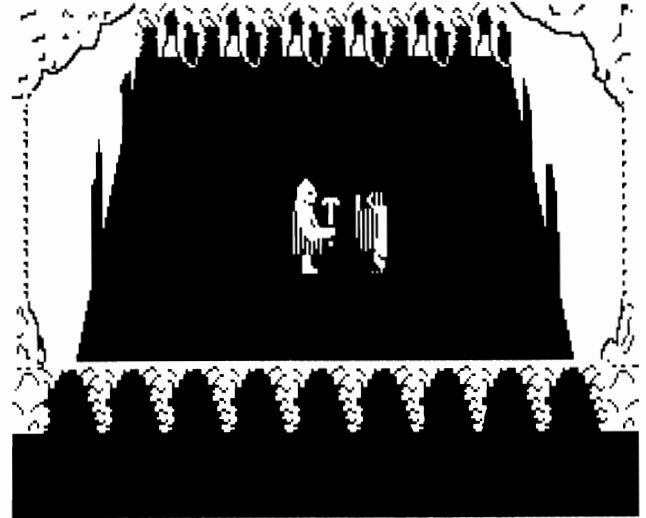
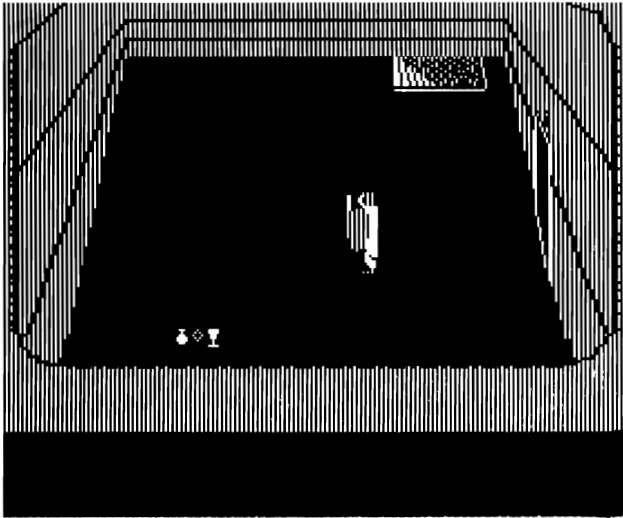

CASTLE OF DARKNESS

Maze

Eerie

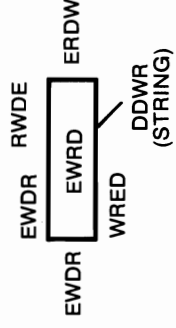
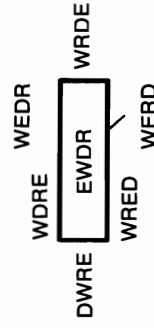
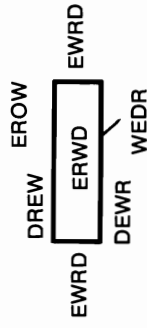
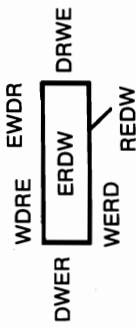
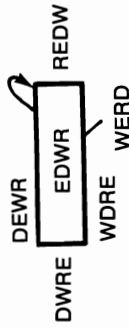

Dark

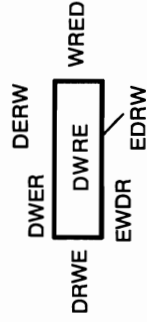
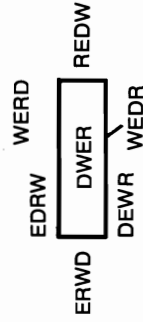
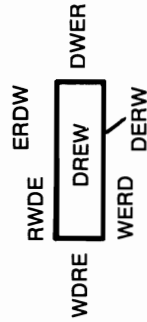
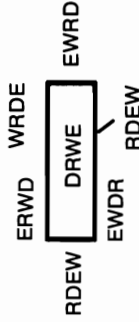
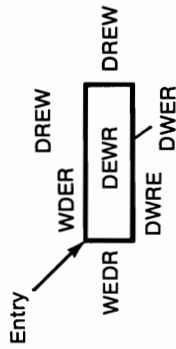
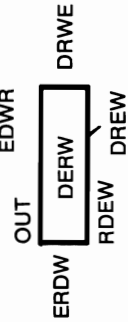

Rocky

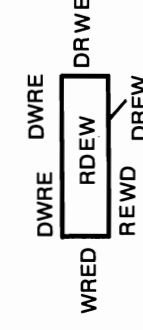
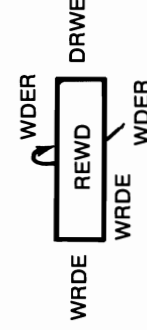
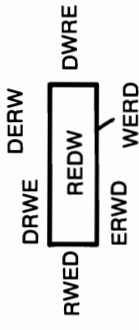
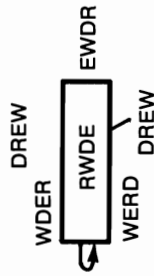
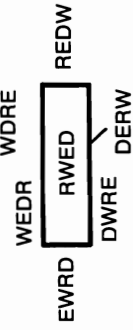

Winding

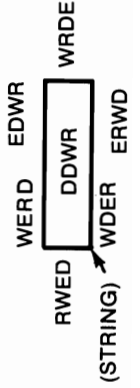
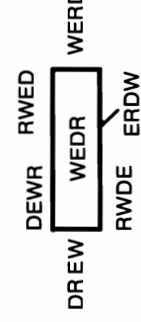
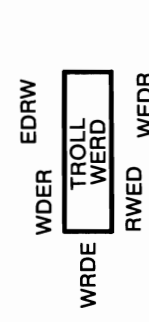
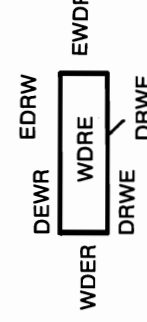
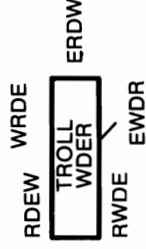
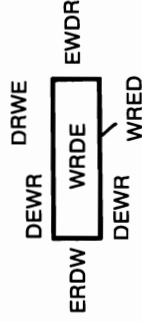

Note: Letters refer to the first letter of the four adjectives.

CHAMBERS OF XENOBIA

Company: Avant-Garde Creations

Suggested Retail: \$15.95

Type: All-text adventure.

Description:

Thirteen treasures await you in the underground cavern, the majority guarded by an unsavory critter which you must kill to gain reward. Three minor puzzles offer some challenge.

Playability:

The game is easily mapped, offers little reason to play a second time, and contains no unique twists. On the other hand, it's easy to play, doesn't bomb, isn't devious, and well suits young adventurers. Not recommended for intermediate to advanced players.

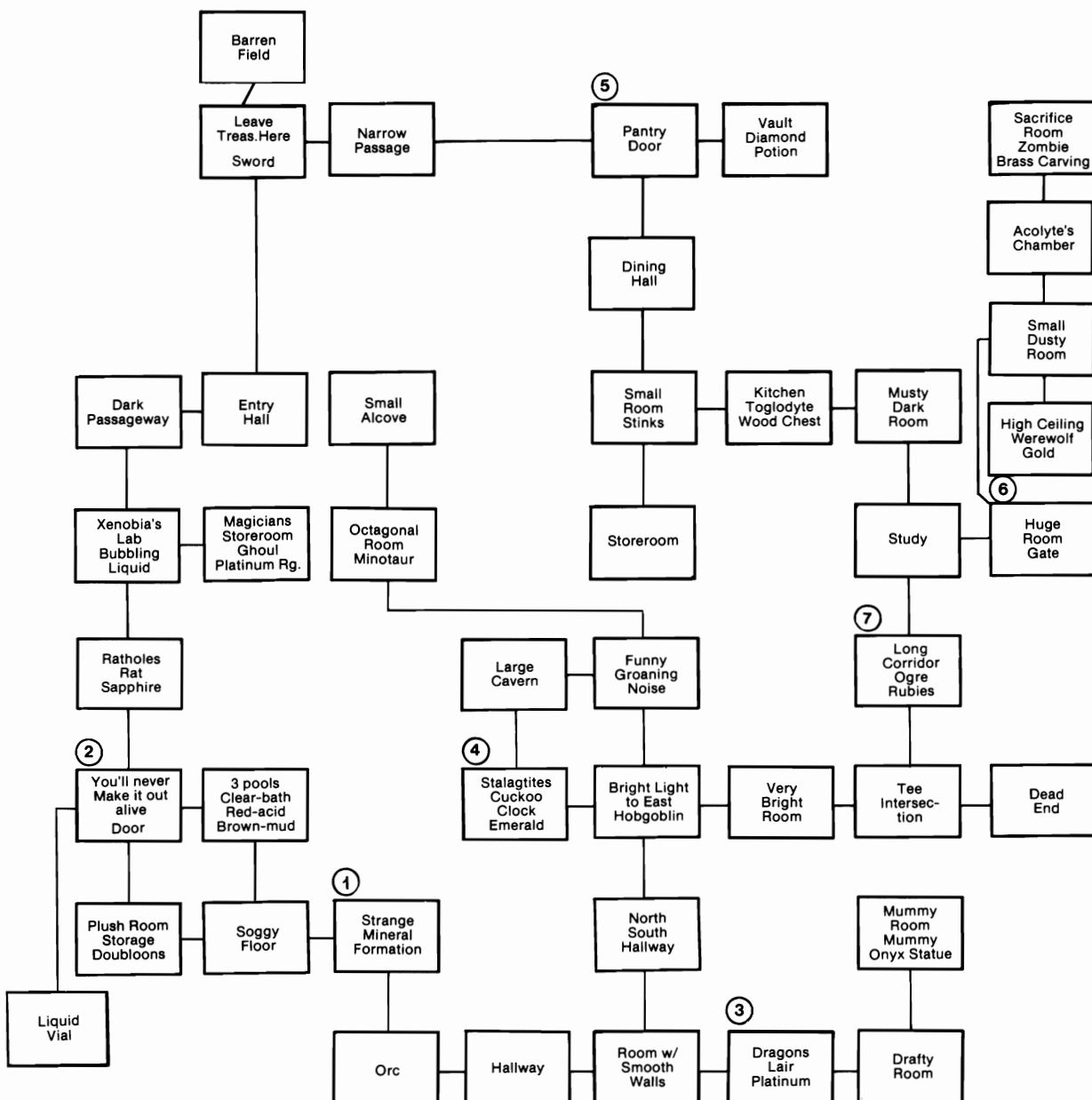

THE COUNT

Company: Adventure International

Suggested Retail: \$39.95

Type: An all-text game, scheduled for release in Hi-Res form. Price includes *Voodoo Castle* and *Strange Odyssey*.

Description:

While this game has relatively few locations, a new element—time—has been introduced. You must properly time-phase your activities over three days and nights in order to find and kill Count Dracula. If you don't fix his wagon in three days, you won't be around for the fourth. Natch, there are bats, garlic, blood, Transylvanian cigarettes and some No-Doze pills to help you keep awake at night.

Playability:

Slightly less complex perhaps than some of the other Scott Adams' games, but unique in that "things change" between night and day, and between successive days. The two-word syntax has a limited but adequate vocabulary. As with all of the Adams games, the text is brief and to the point. The game offers a single, easily made or recalled saved-game.

THE COUNT

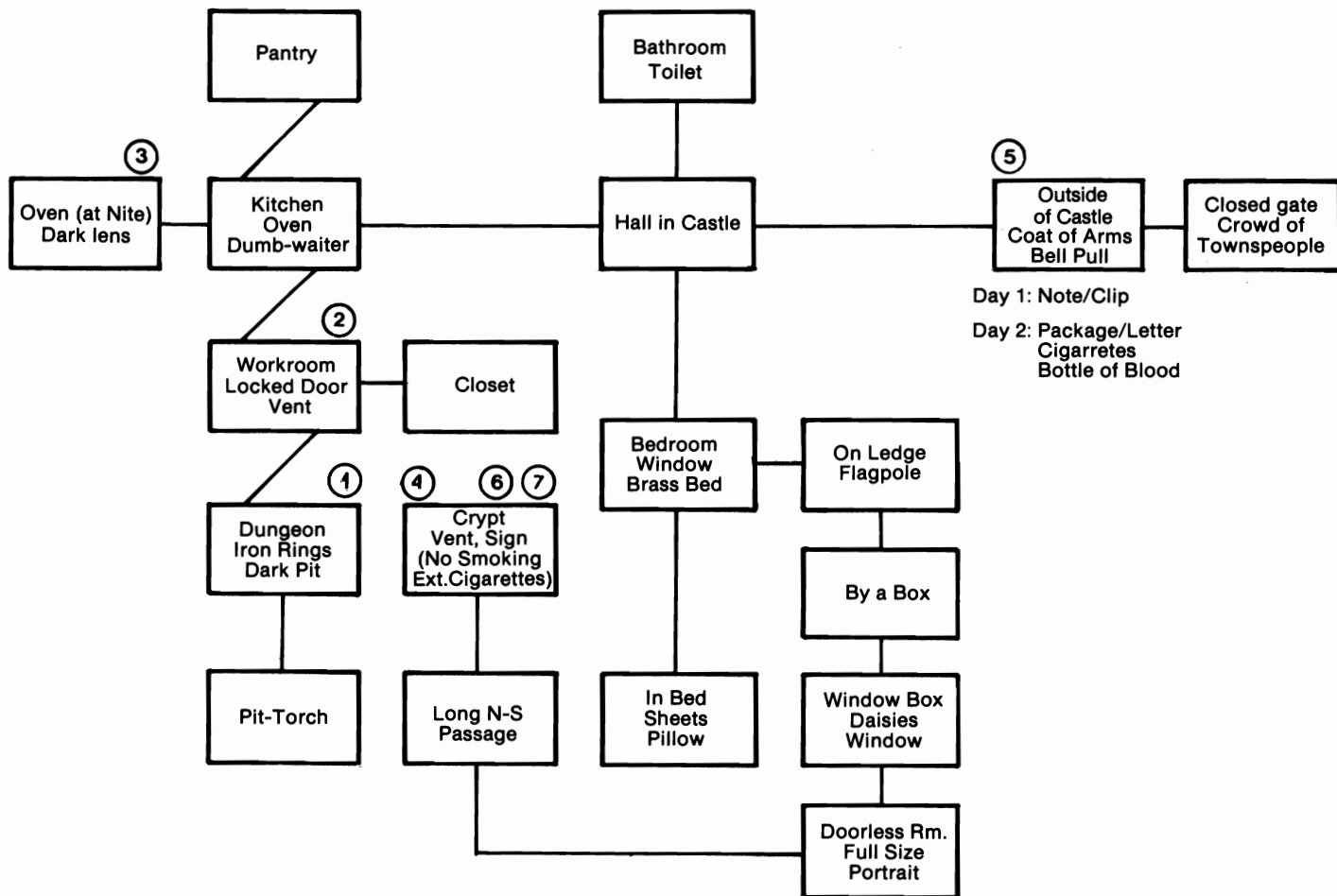

THE COVETED MIRROR

Company: Penguin Software

Suggested Retail: \$19.95

Type: Hi-Res adventure with color graphics.

Description:

To break the evil rule of King Voar, you must find the fifth piece of a magic mirror. To do so, you must know the shapes of the other four pieces, solve a number of related puzzles, and play three simple arcade games. Periodically, the King yanks you back if the Jailer finds you missing, but the Jailer lets you roam if you bribe him.

Playability:

“Talking” characters will help you order and solve the frequent but not overly difficult puzzles. The characters often give novel responses should you give them objects not intended for them. A light-hearted game with nice graphics and a degree of animation, but a rather slow fill time. The vocabulary is nicely tailored to the game. You get seven saved-game positions, which you should use frequently—especially in the maze. Suitable for all levels of gaming ability.

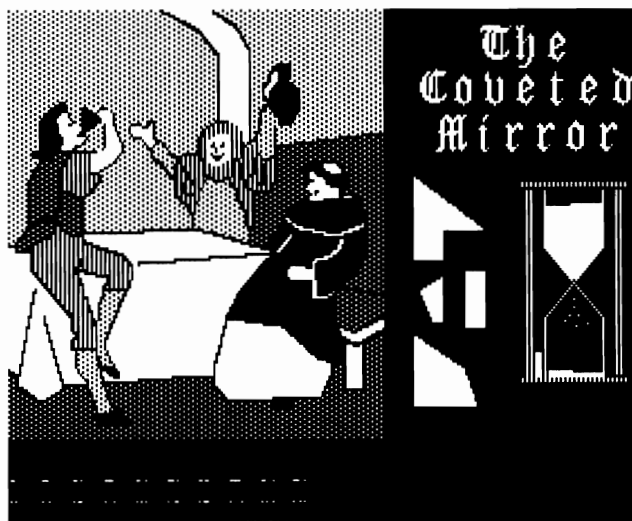
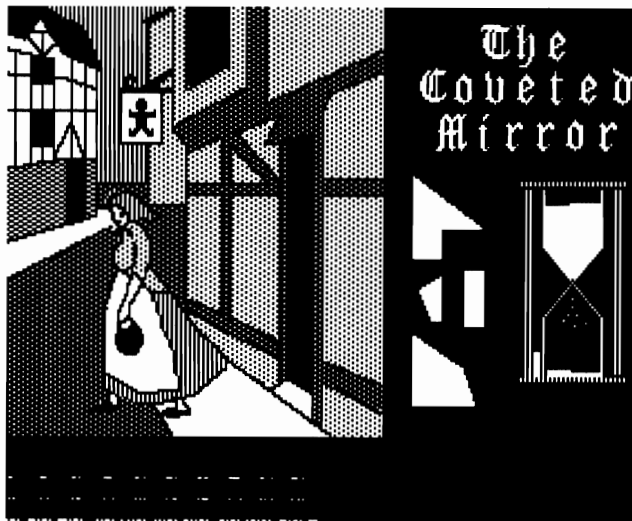

THE COVETED MIRROR

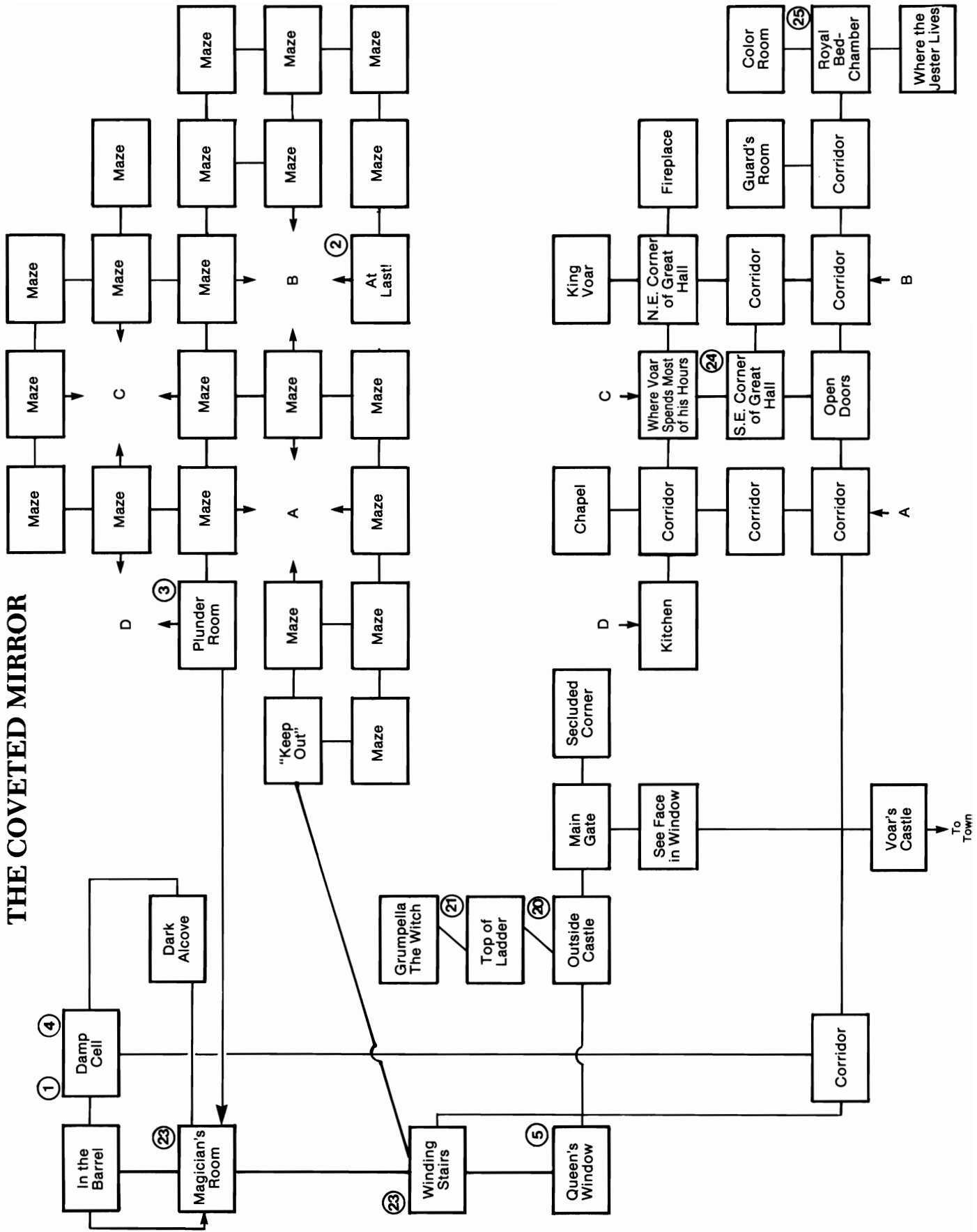

THE COVETED MIRROR

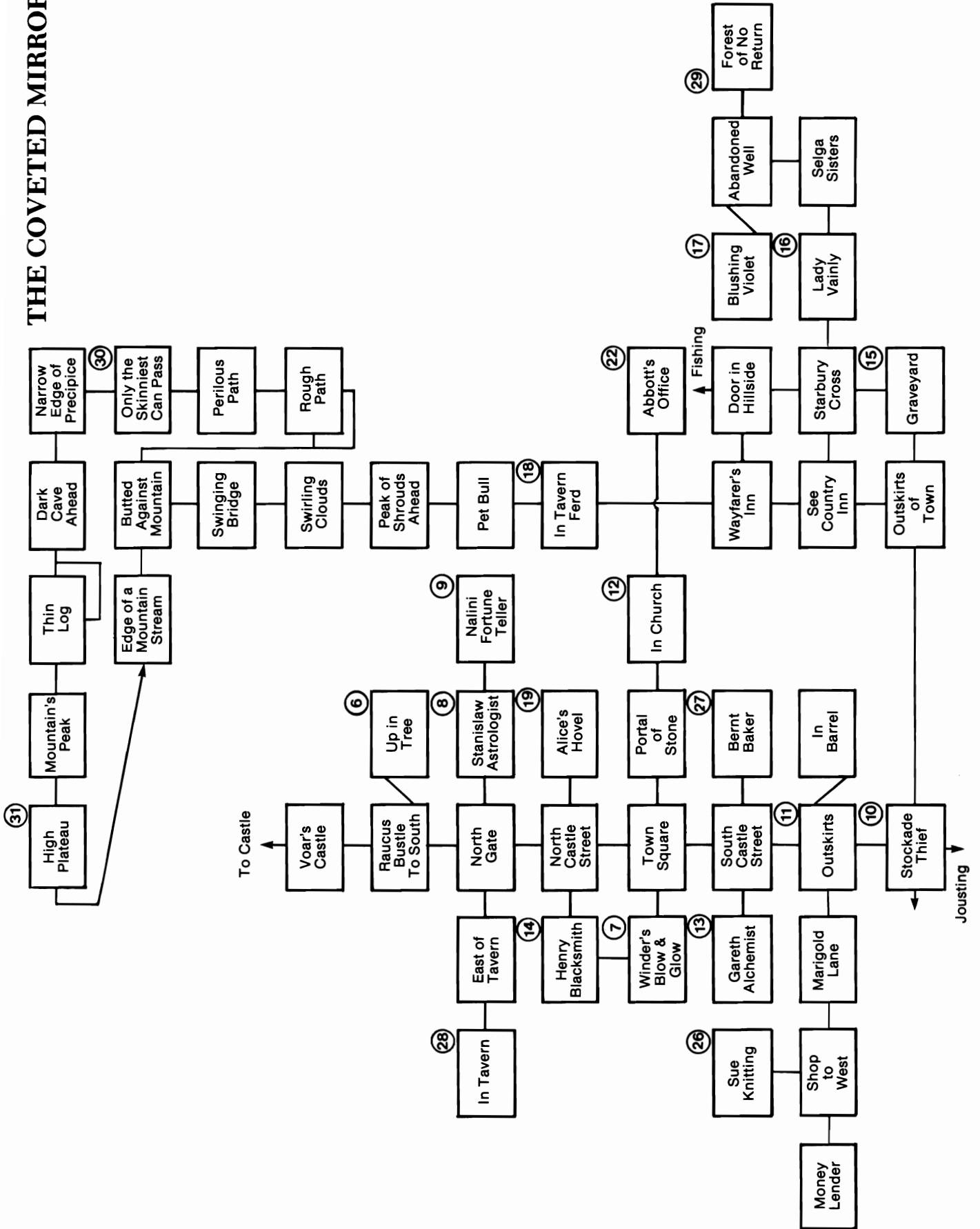

CRANSTON MANOR

Company: Sierra On-Line Systems

Suggested Retail: \$34.95

Type: Hi-Res adventure with color graphics.

Description:

You must recover sixteen treasures from the multi-roomed Manor so that the town can be restored to its former glory. *Cranston Manor* itself is all indoors—upstairs, downstairs, and basement—with a Suit of Armor chasing you in the house and a dangerous Toy Soldier after you in the basement. The conclusion extends congratulations and designates you a Class 3 Adventurer!

Playability:

The game provides a few sticky puzzles and several interesting interconnections, but the inability to restore or restart the game after getting killed off is a serious problem! Despite the relatively large size of this game, it seems to lack the imagination and freshness which marked *The Wizard and the Princess*.

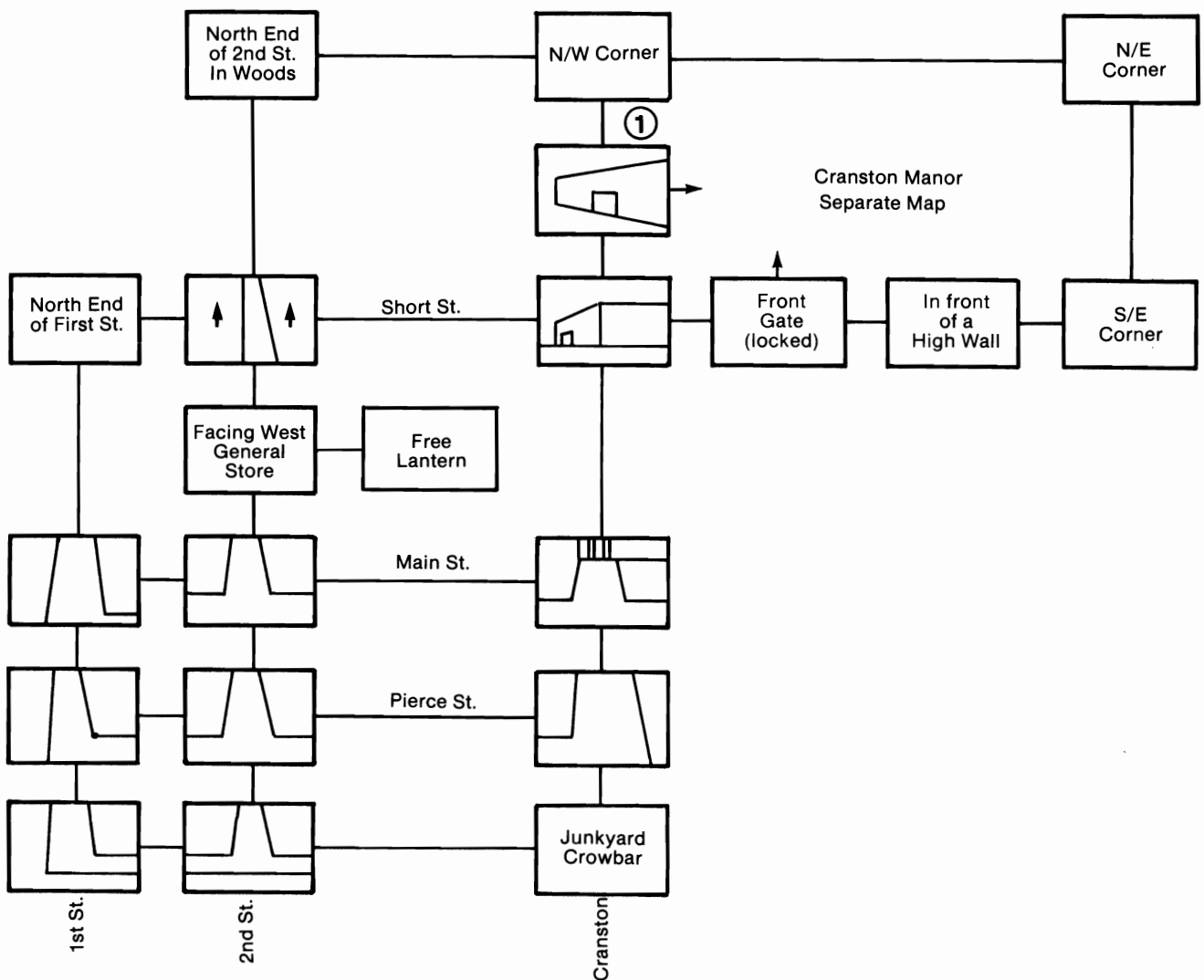

CRANSTON MANOR

Basement

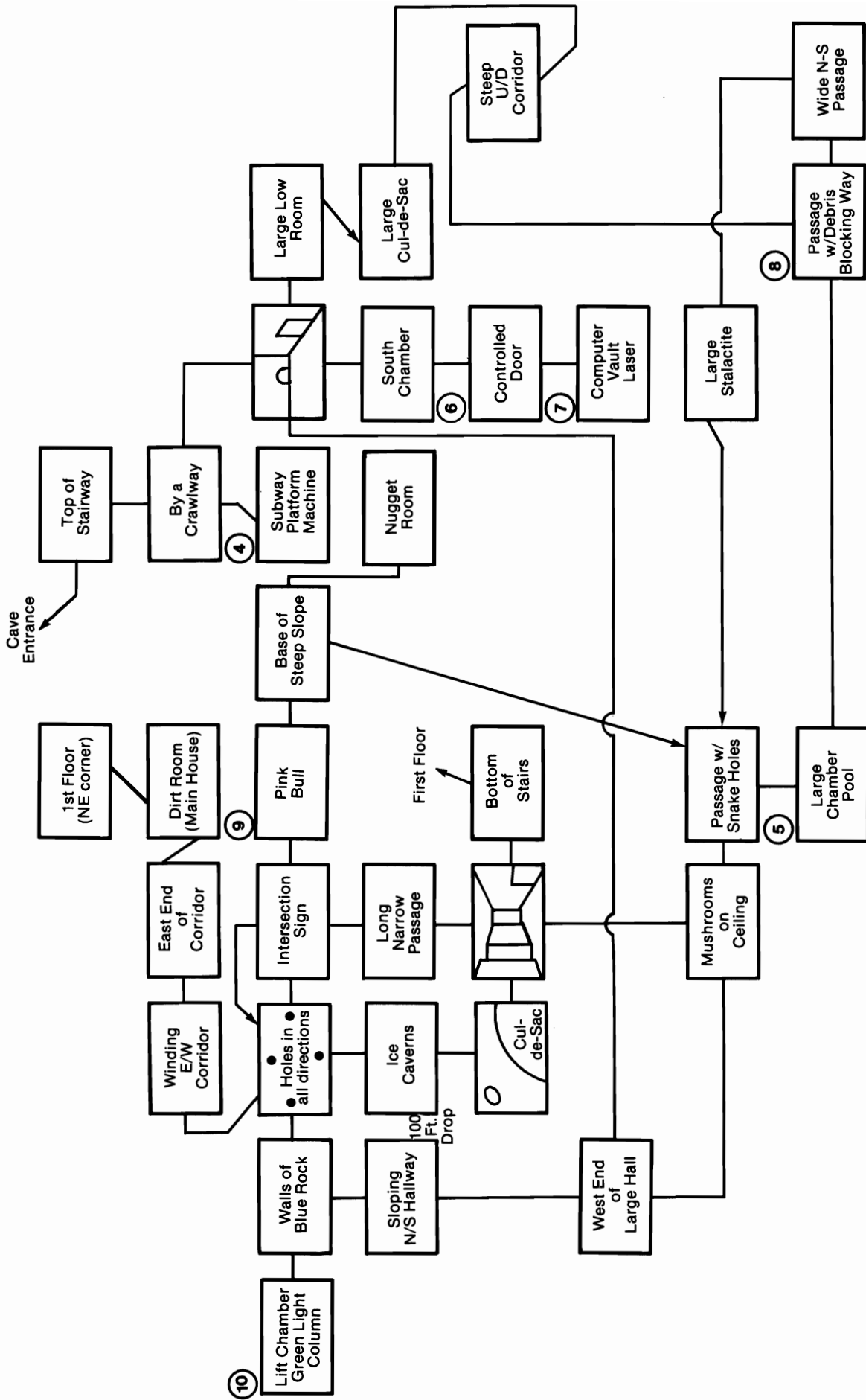

CRANSTON MANOR

Hires Adv. No. 3

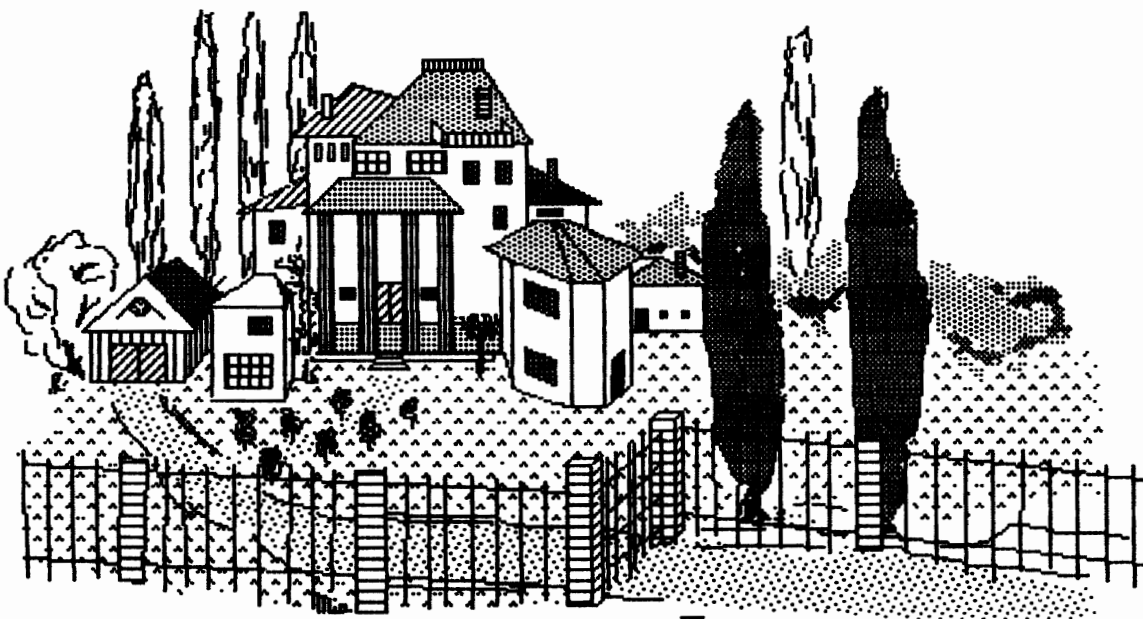
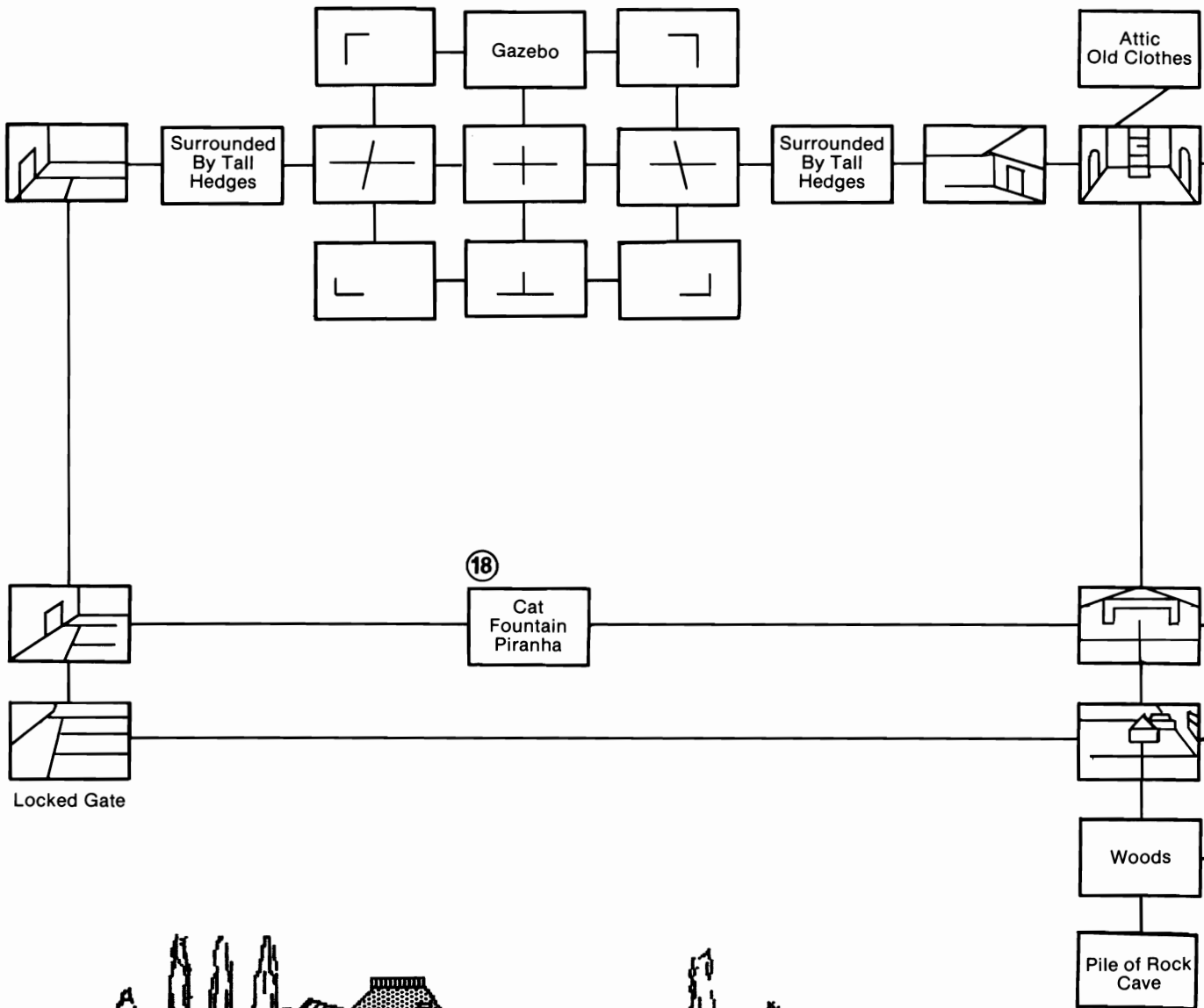

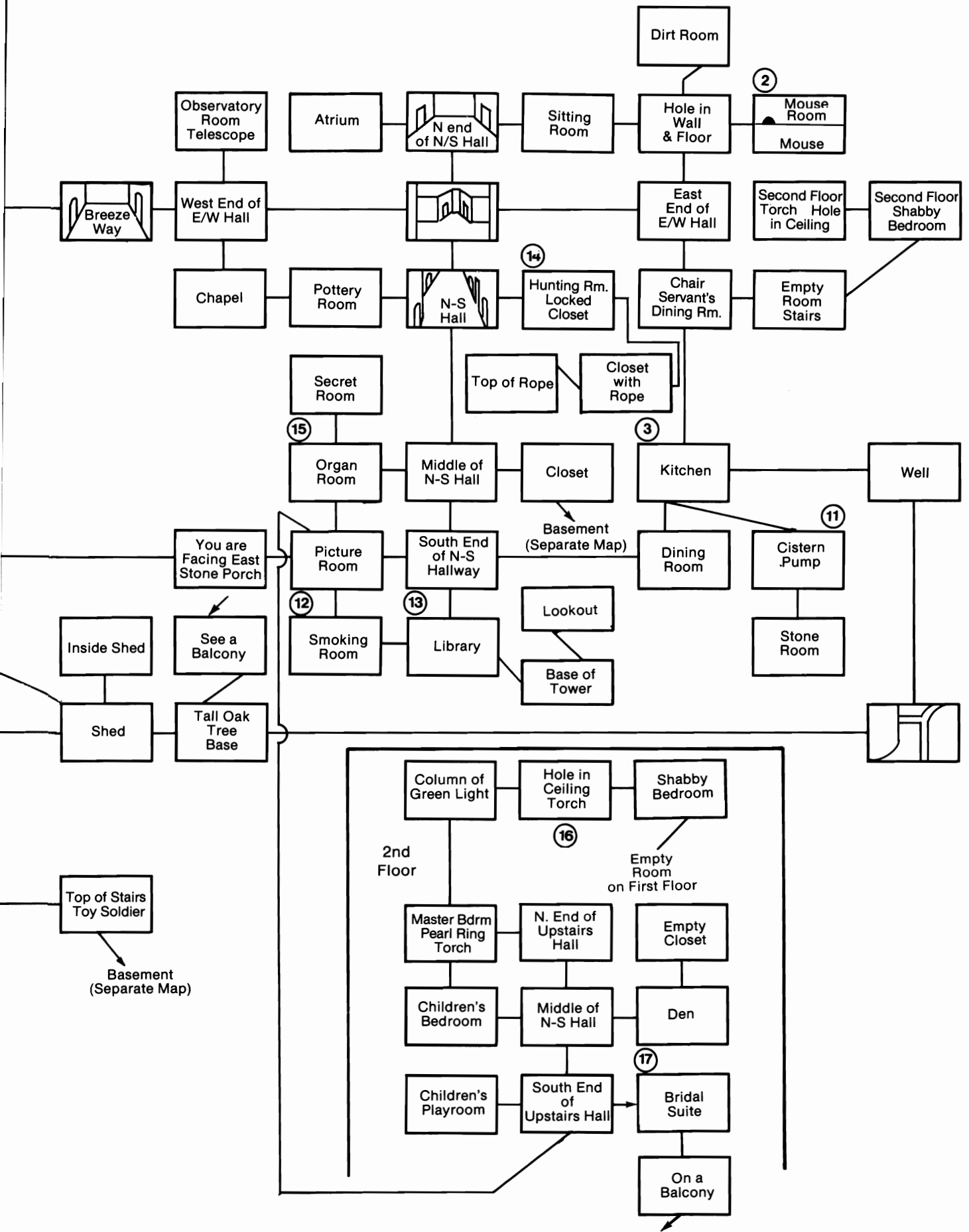

CREATURE VENTURE

Company: Highland Computer Services

Suggested Retail: \$24.95

Type: Black and white Hi-Res adventure.

Description:

You enter and explore a mansion which you have inherited, deal with its inhabitants, and find the treasure, which is in two parts. Once you find the first part of the treasure, you enter a Master's Game, made more difficult because it no longer allows you the save-game feature and essentially limits the number of moves available to you.

Playability:

A few interesting animation sequences and challenging portions. Adult adventurers may become bored quickly because of the limited vocabulary, but kids will find this game, written somewhat tongue-in-cheek, rather interesting.

Master Game

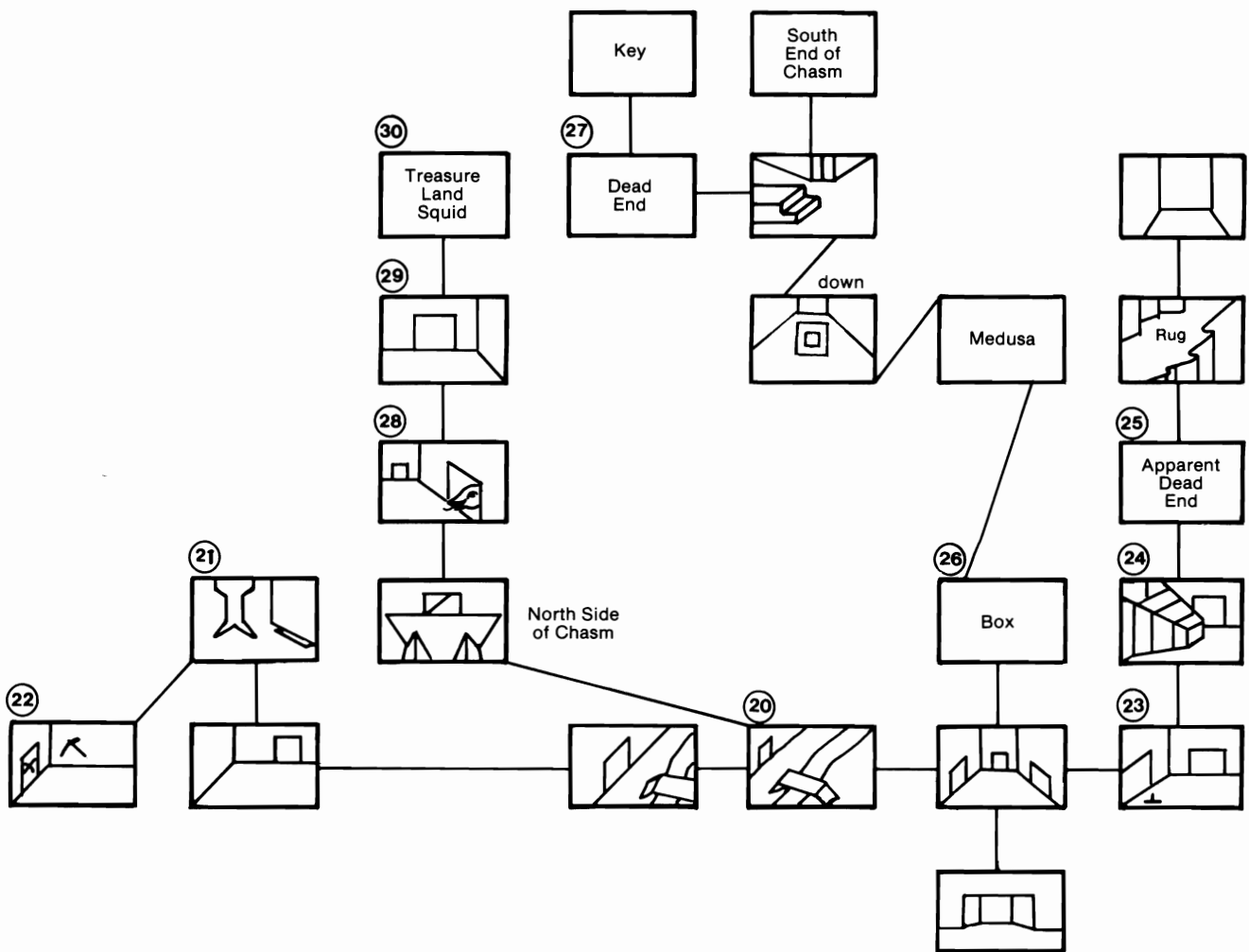

CREATURE VENTURE

Part I

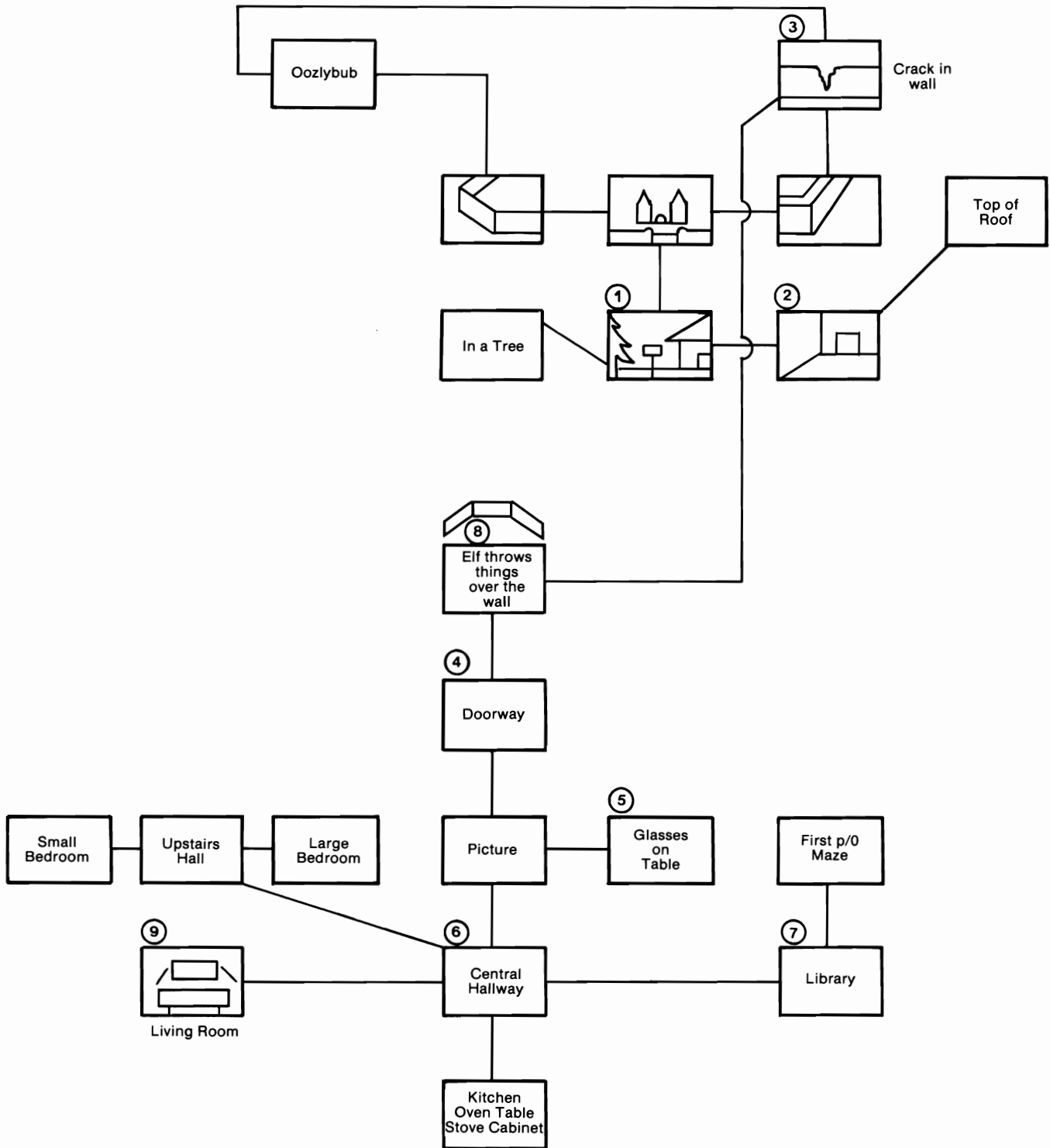

CREATURE VENTURE

Maze

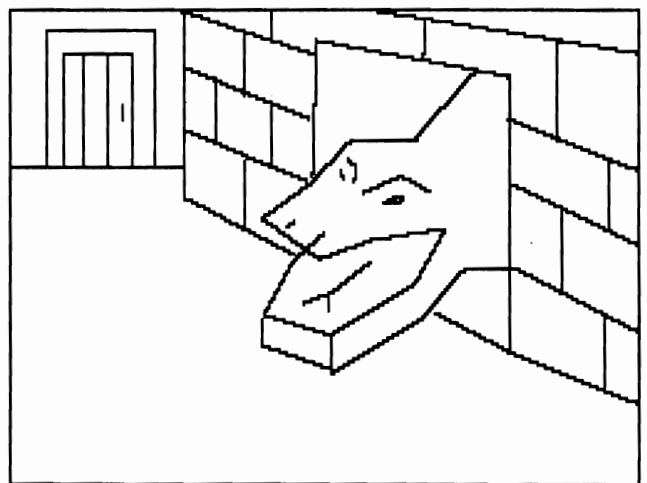
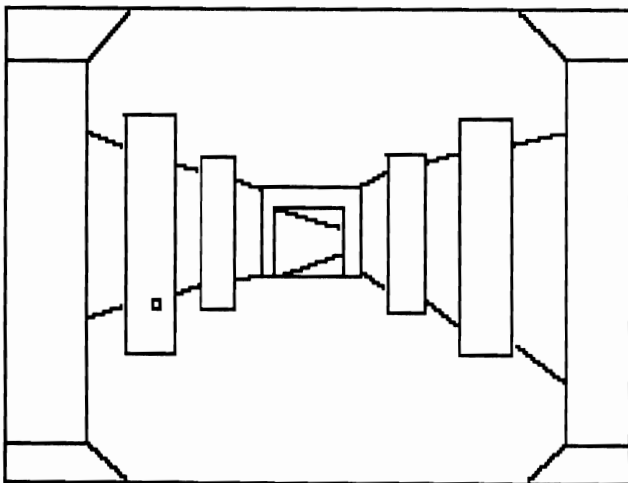
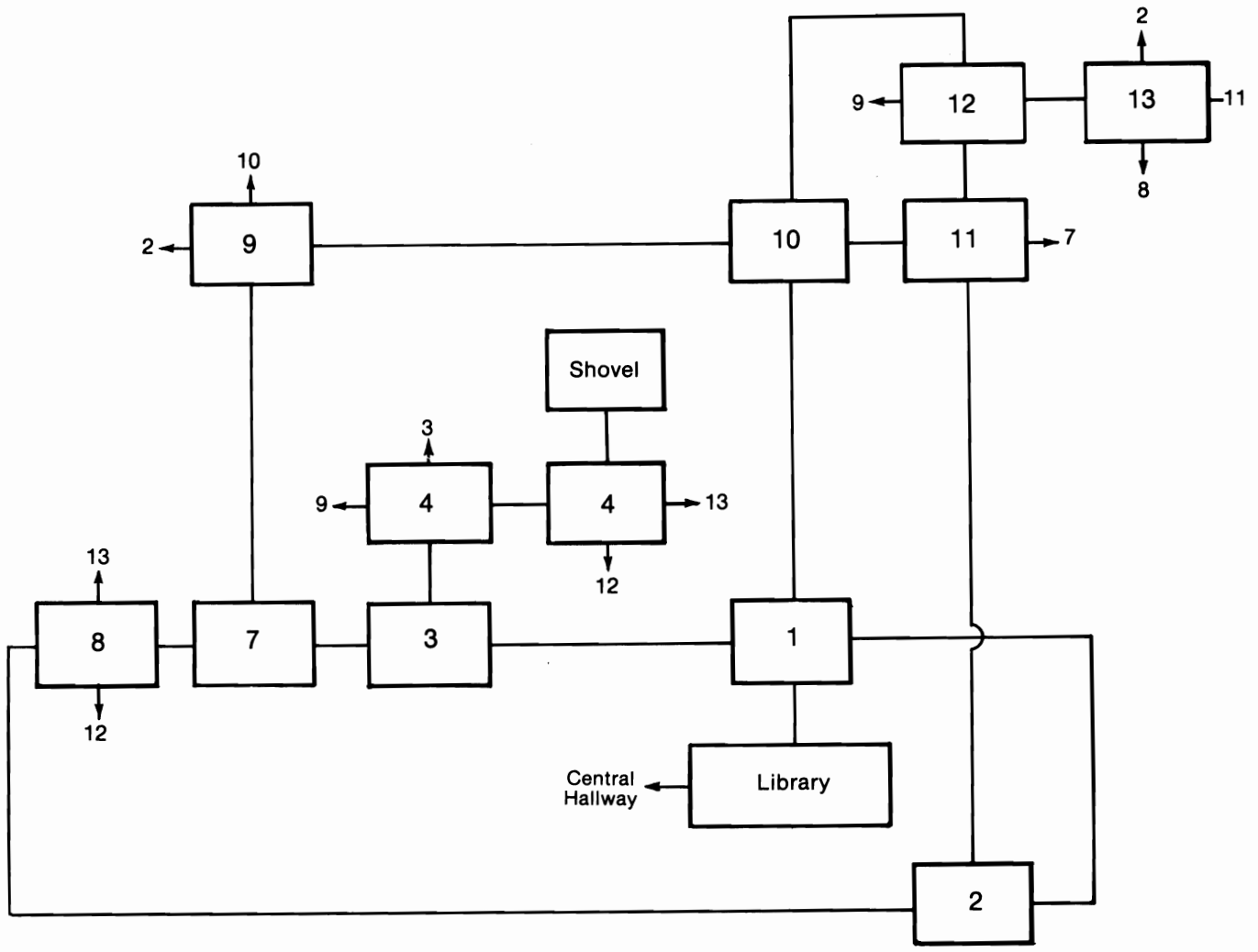

CREATURE VENTURE

Part 2

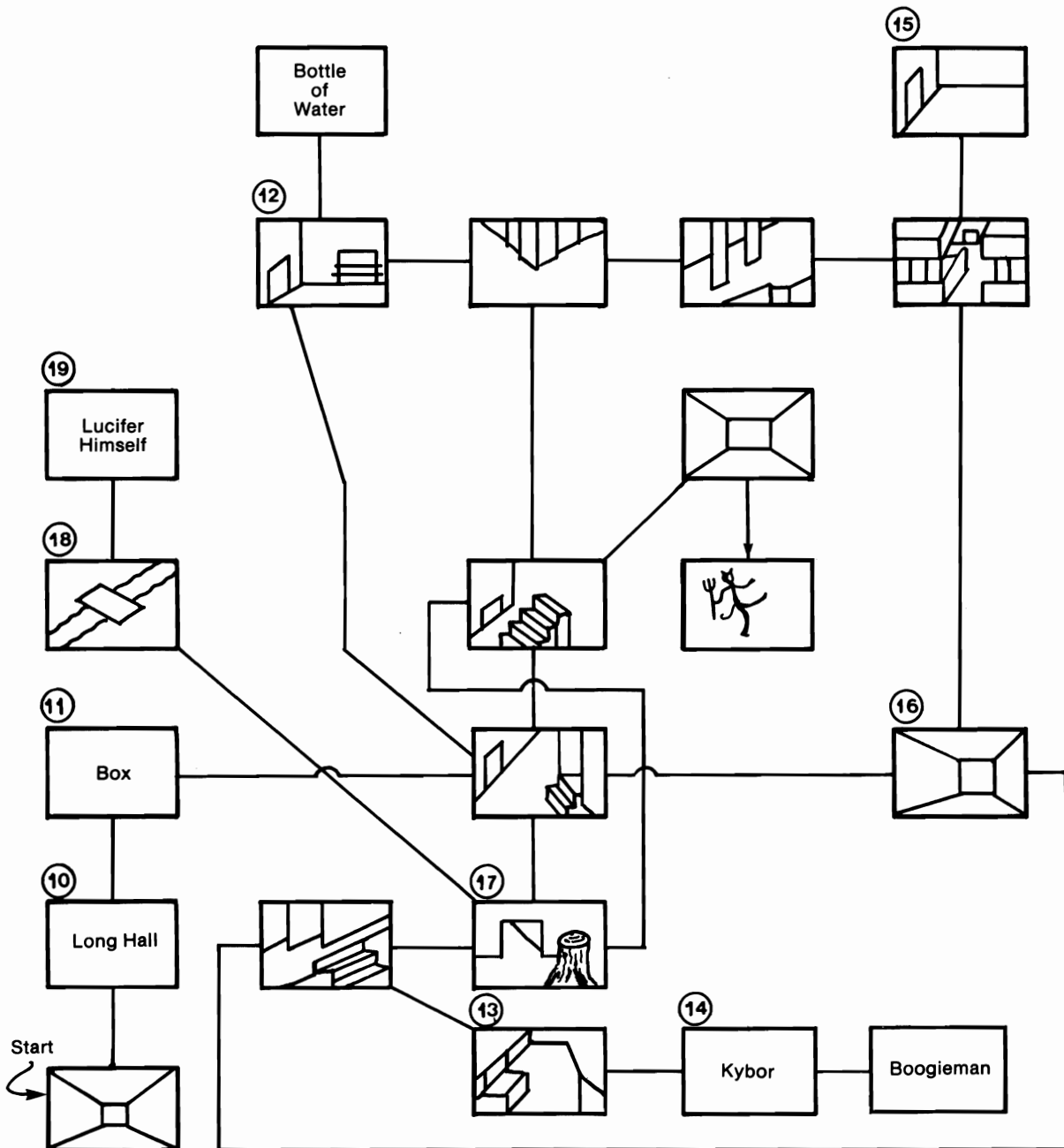

CRIME STOPPER

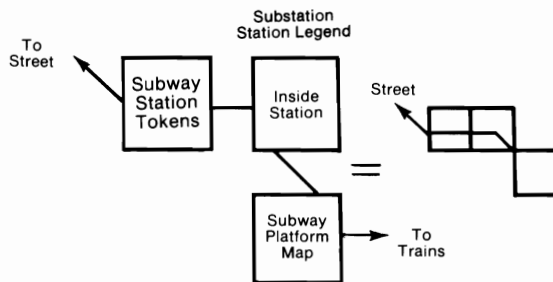
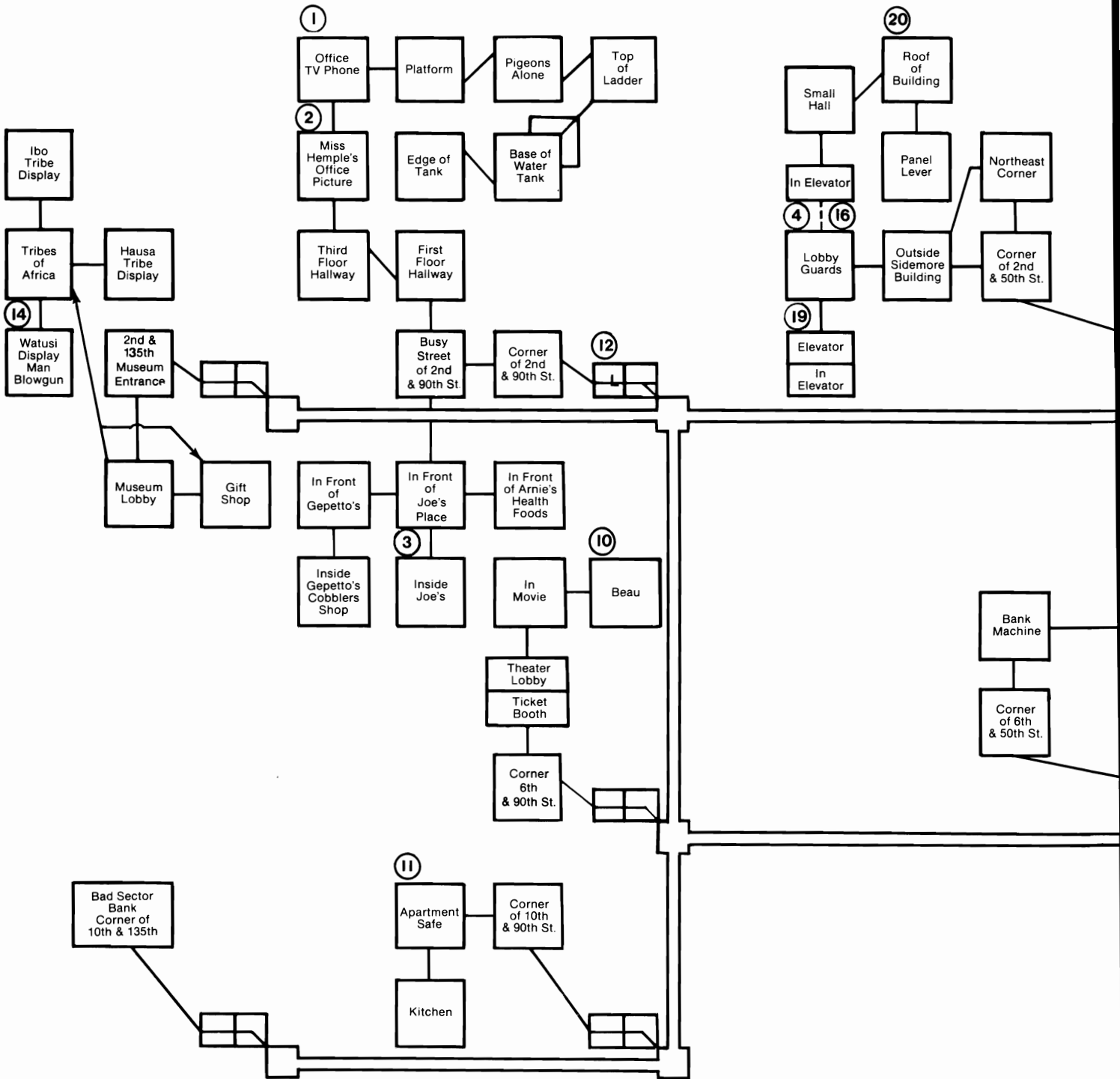

CRIME STOPPER

Company: Hayden Software

Suggested Retail: \$34.95

Type: All-text mystery game.

Description:

You are Al Clubs, Private Investigator. You arrive at your office at 7 a.m. to find that you have been hired to recover a kidnapped heiress. You have until midnight to complete your task. You spend a lot of time in the subway. En route, you have plenty of reading material and you encounter two dead bodies. You have to do in three baddies or become a corpse yourself. Justice is swift, so work fast!

Playability:

There are a few bugs in this game, so save it often (fortunately, quite an easy thing to do). Novice adventurers will find it entertaining. However, if you got hooked on *Deadline*, don't expect this to replace it.

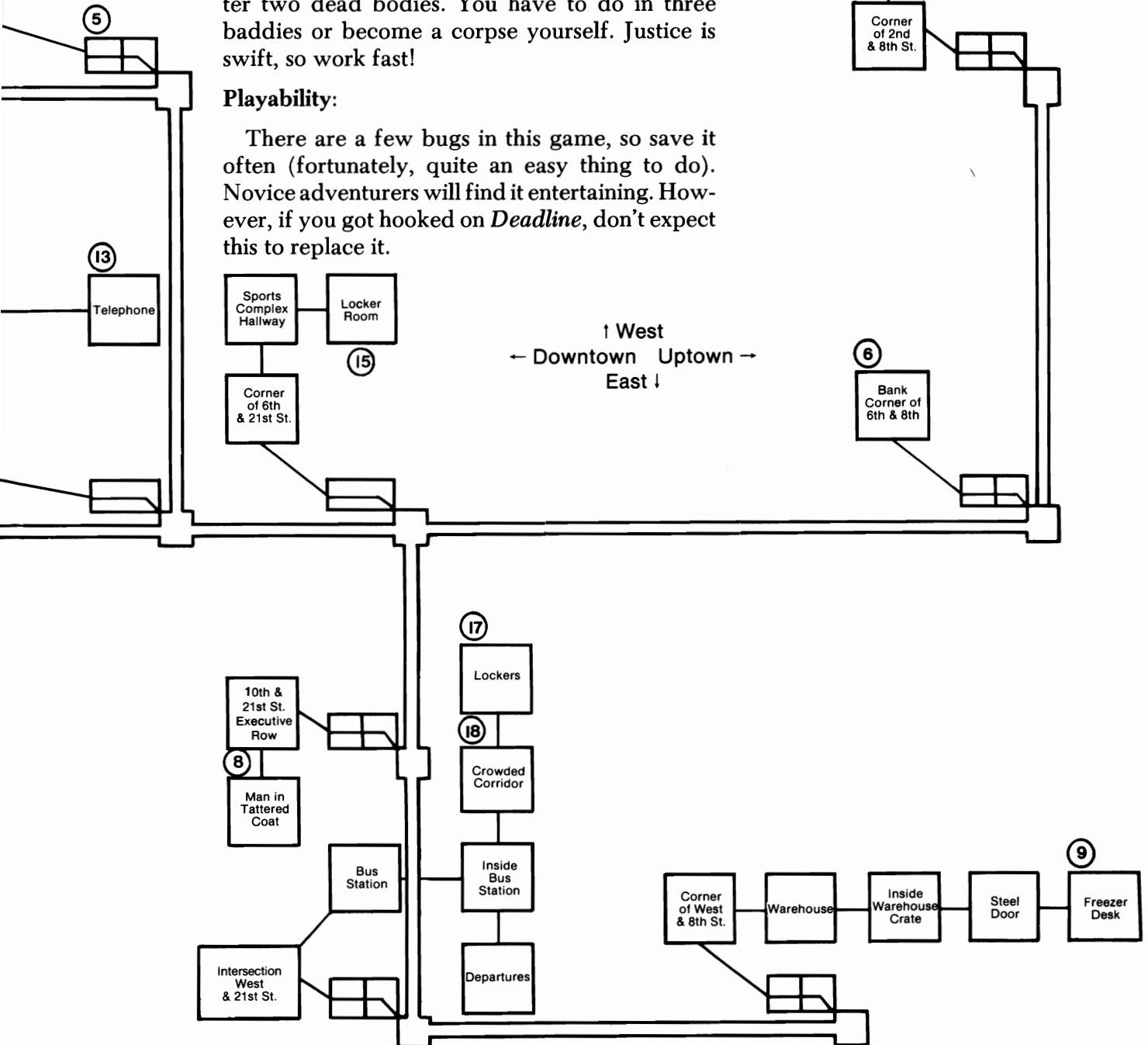

CRYPT OF MEDEA

Company: Sir-Tech Software, Inc.

Suggested Retail: \$34.95

Type: Hi-Res adventure with color graphics.

Description:

A humorless and gruesome game, full of blood, gore, and little else. You find yourself in an underground mausoleum; your mission is simply to escape. Decapitated corpses, flea-infested dogs (dead, naturally), vats full of body pieces, and mutants stand in your way. I can't say much good about this game, either from the standpoint of its design or implementation.

Playability:

This game does not suit children because of its unnecessary use of violence and horror. The graphics and text are rather insipid. Nonetheless, the difficulty factor is relatively high, partly because of the atrocious vocabulary and partly because of the lack of logic associated with the puzzles.

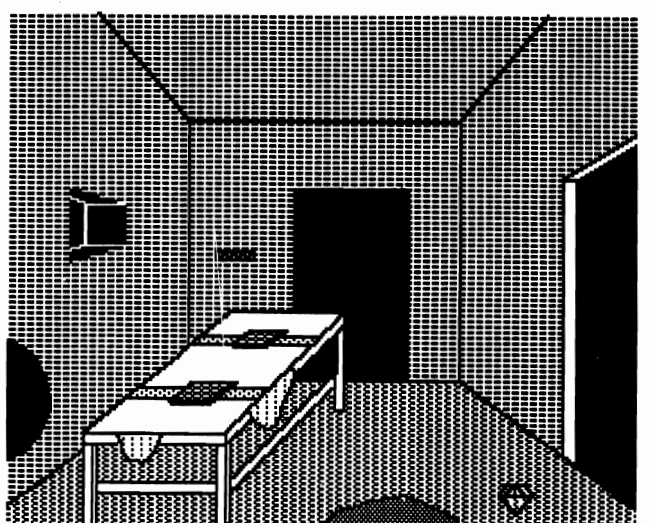
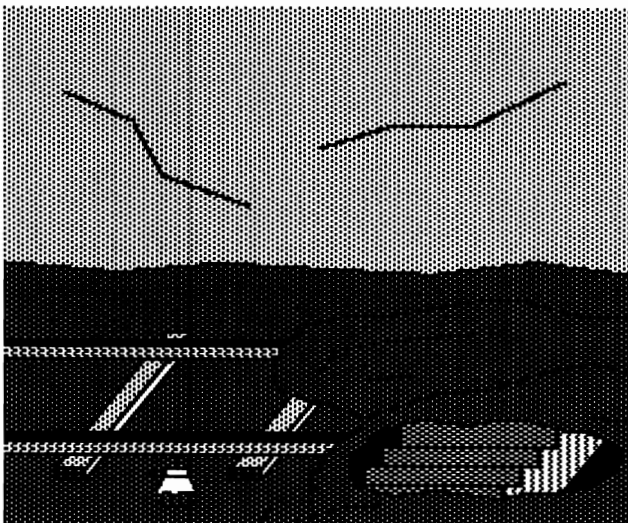
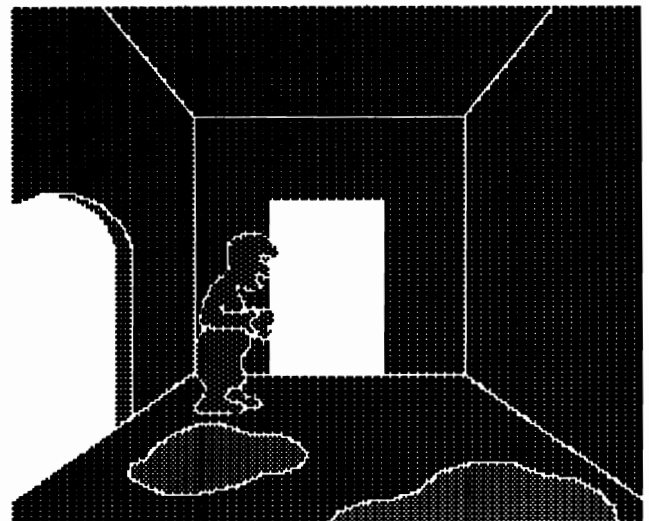
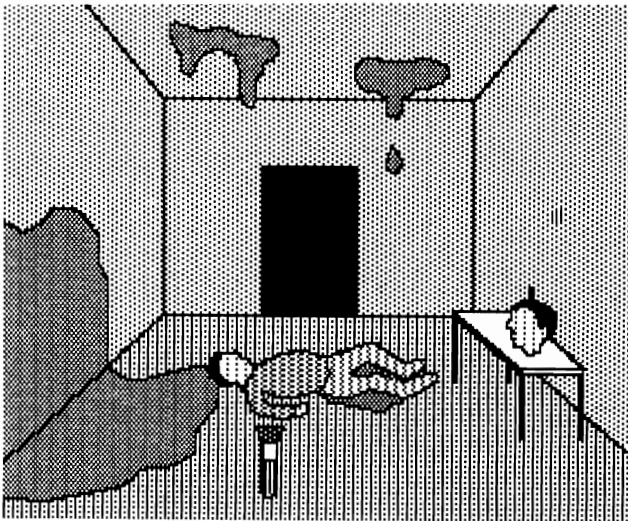

CRYPT OF MEDEA

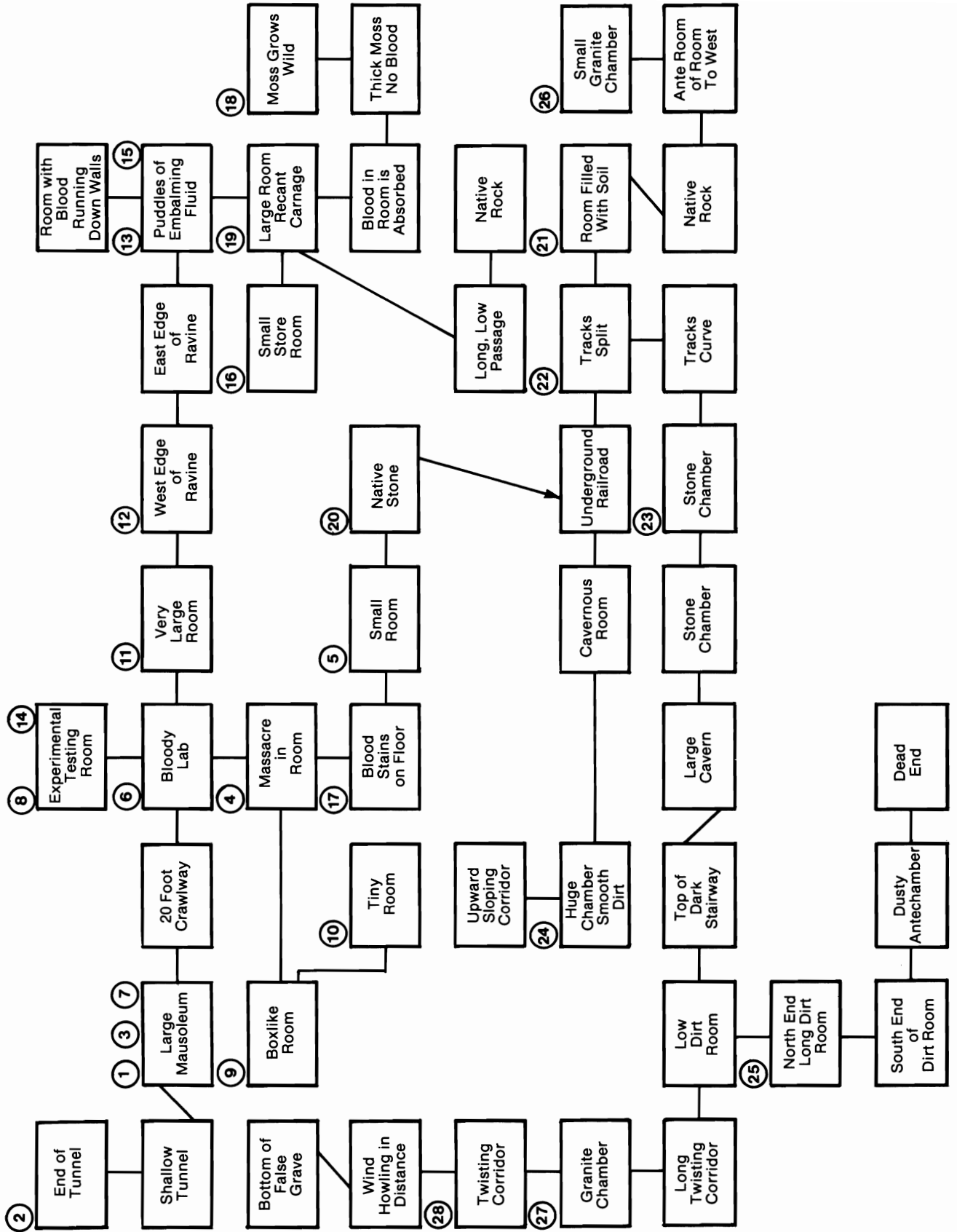

CRYSTAL CAVERNS

Company: Hayden Book Co.

Suggested Retail: \$34.95

Type: All-text adventure.

Description:

You become Apple Caverns Estate Landlord after finding sixteen treasures in and below an old Victorian Mansion. Lots of imaginatively written, highly descriptive text, and several very well done puzzles enhance this game. Also, you must find many objects to figure out which ones to carry where, and which ones to use on what!

Playability:

You have to work hard at getting killed, a welcome change in adventures; but if you insist, try jumping up and down on the rickety bridge! You make the three save-game positions to the program disk. Three are just about right for this game, which is, all in all, rather interesting.

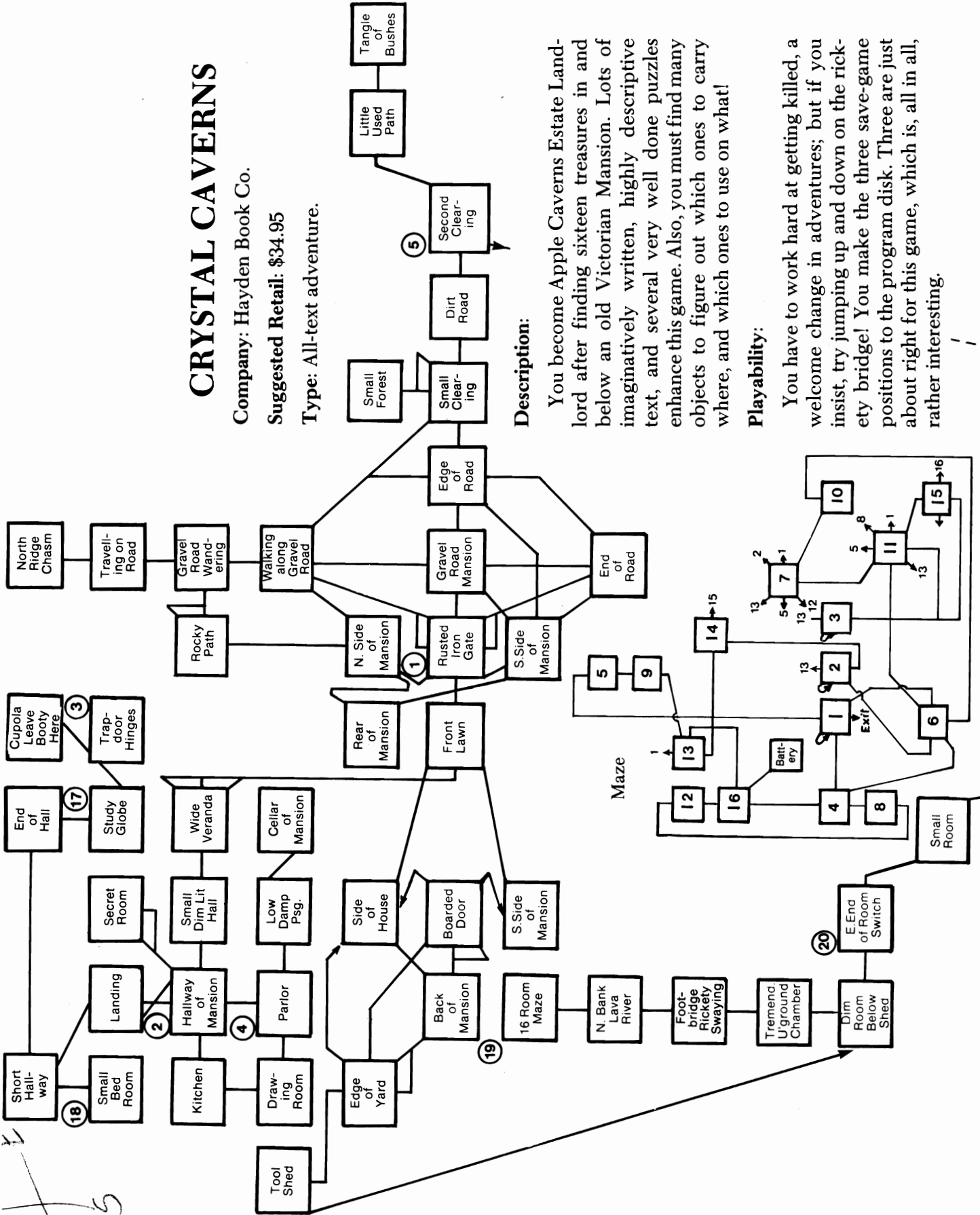

CURSE OF CROWLEY MANOR

Company: Adventure International

Suggested Retail: \$29.95

Type: Hi-Res mystery with color graphics.

Description:

As Inspector Black, you start in your Scotland Yard office (which you cannot leave until the phone rings). An officer (later found gruesomely mutilated) summons you to Crowley Manor to investigate the murder of Lord Crowley. The balance of the game proves equally gruesome, but the ending is interesting and well done.

Playability:

You will find it all too easy to get stuck at one location in this guessing game, looking for the right word combination in a full sentence command. Quite often, otherwise insurmountable obstacles simply disappear if you happen to be carrying the proper object, so be sure to look everywhere.

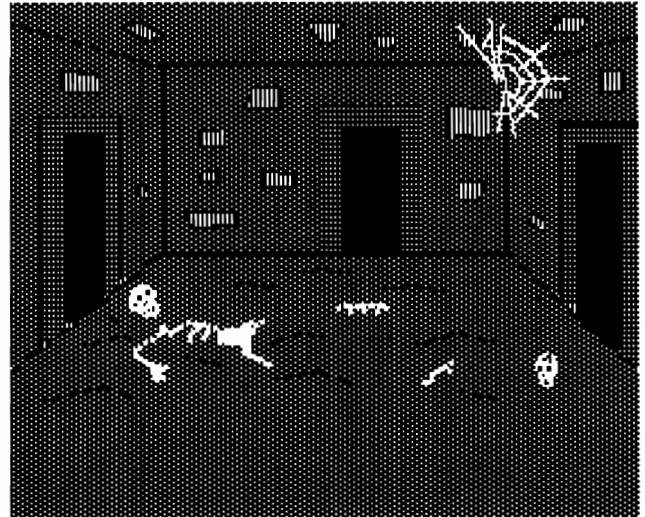
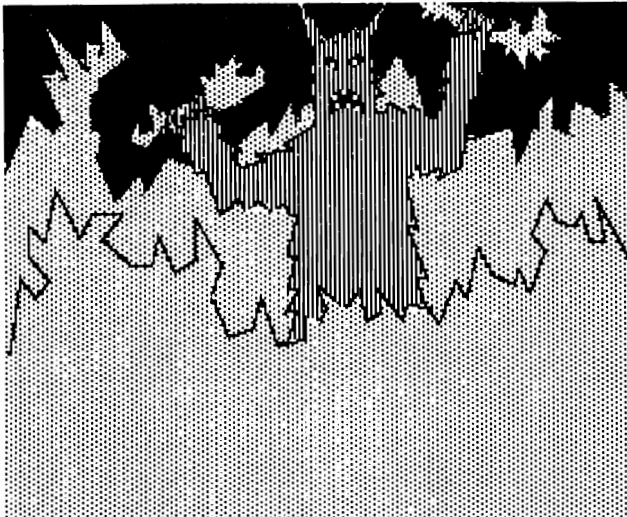

THE CURSE OF CROWLEY MANOR

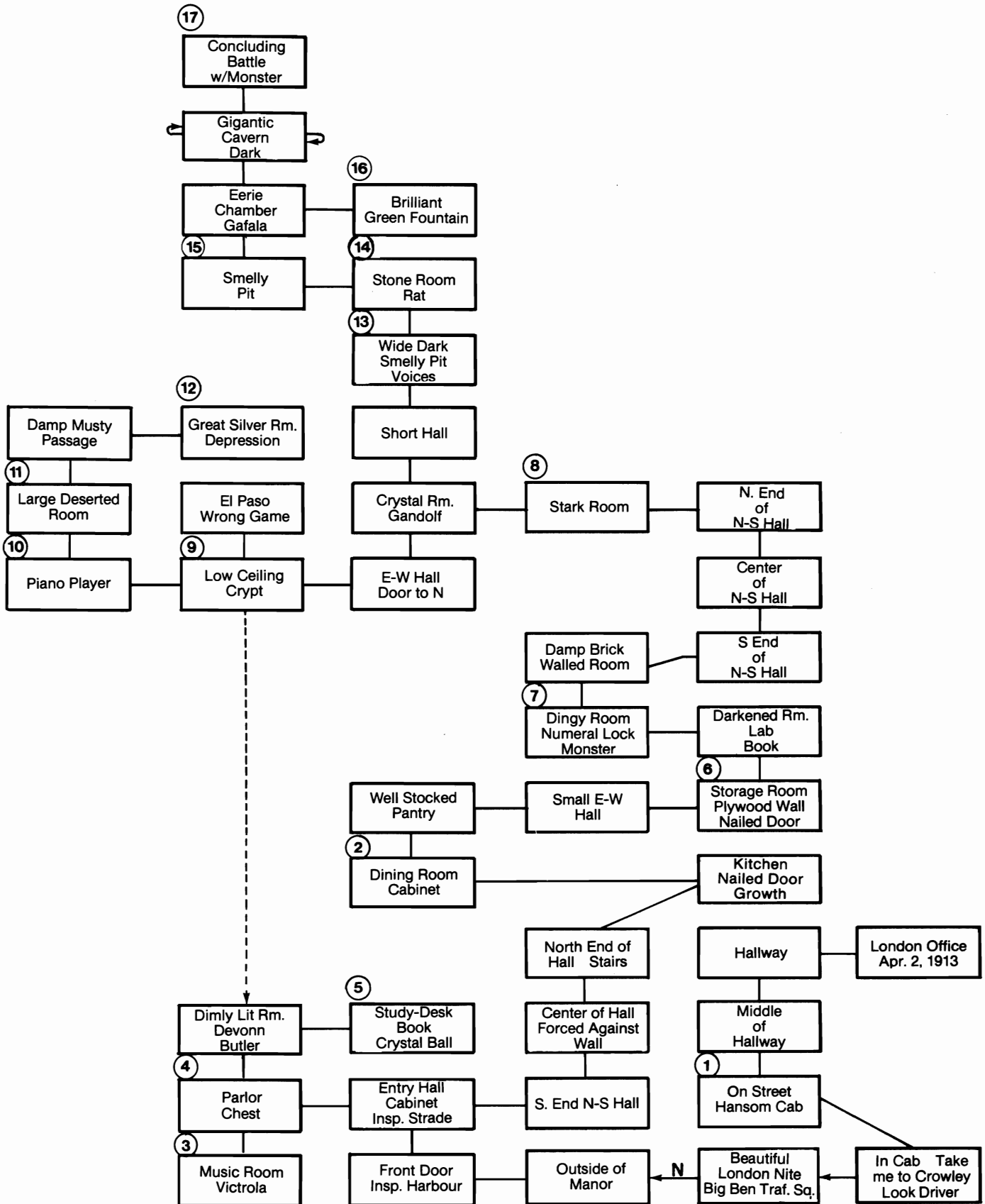

CYBORG Part 1

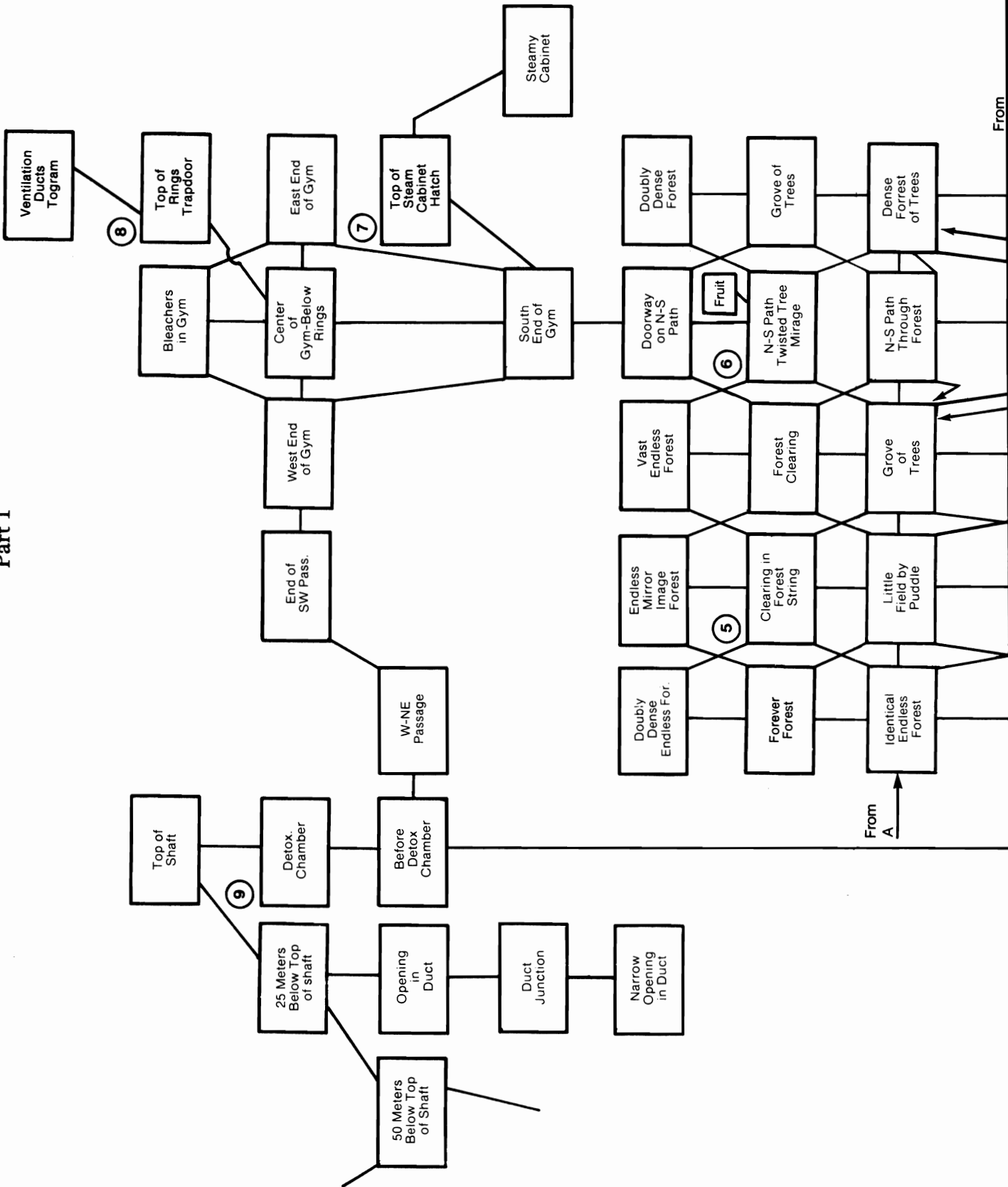

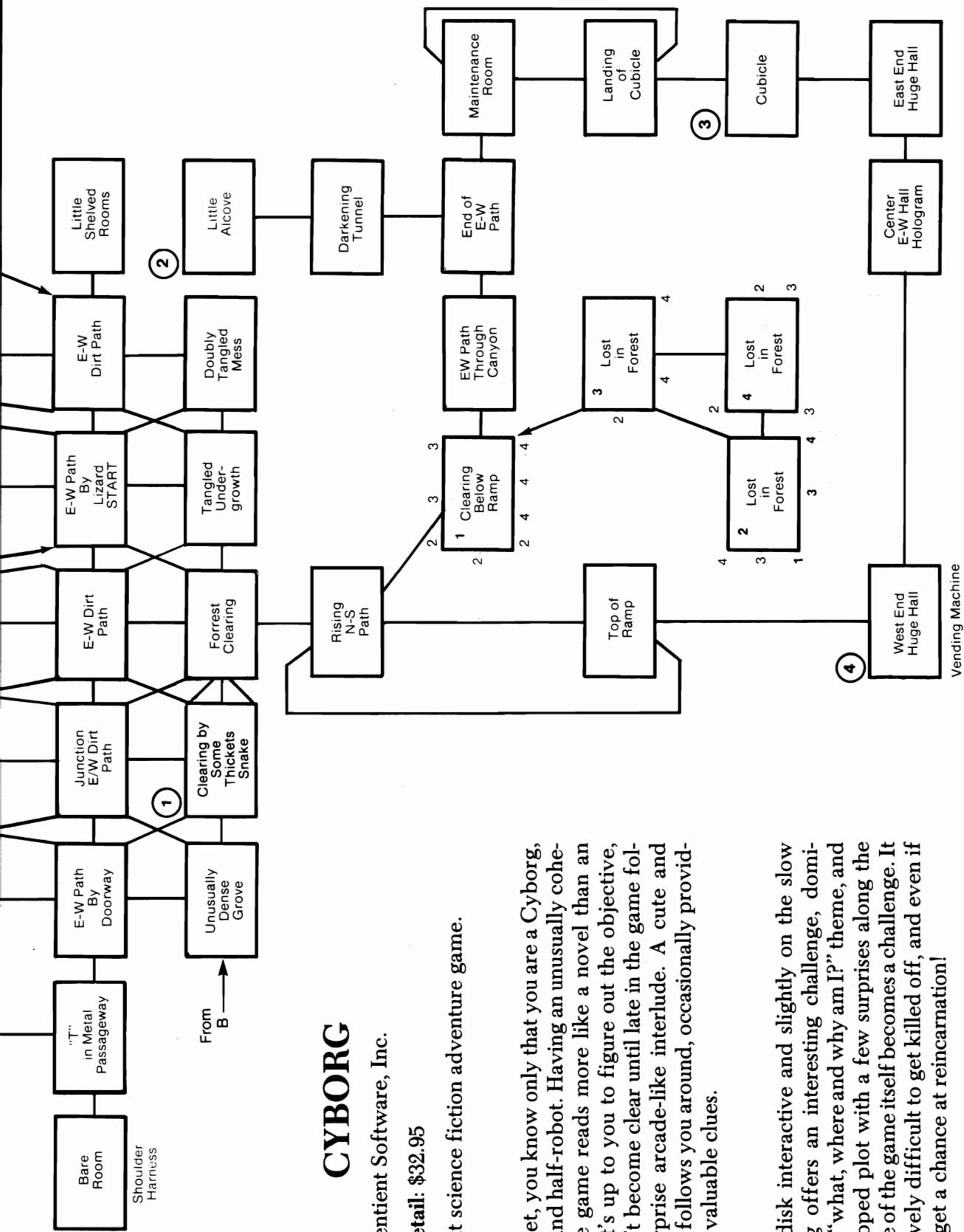

CYBORG

Company: Sentient Software, Inc.

Suggested Retail: \$32.95

Type: All-text science fiction adventure game.

Description:

At the outset, you know only that you are a Cyborg, half-human and half-robot. Having an unusually cohesive plot, the game reads more like a novel than an adventure. It's up to you to figure out the objective, which doesn't become clear until late in the game following a surprise arcade-like interlude. A cute and clever Droid follows you around, occasionally providing you with valuable clues.

Playability:

Although disk interactive and slightly on the slow side, *Cyborg* offers an interesting challenge, dominated by the "what, where and why am I?" theme, and a well-developed plot with a few surprises along the way. The size of the game itself becomes a challenge. It proves relatively difficult to get killed off, and even if you do, you get a chance at reincarnation!

DARK CRYSTAL

Company: Sierra On-Line Systems

Suggested Retail: \$39.95

Type: Hi-Res fantasy adventure, the sixth in the Roberta Williams series, with color graphics.

Description:

Jen, our Gelfling hero, is your alter ego. You control his actions in his quest to find and replace the missing shard of the Great Crystal, a deed which must take place at the instant of the triple conjunction of the Three Suns. The great prophecy states that only a Gelfling can accomplish this task, and Jen is one of only two who escaped the slaughter of his race by the evil Skeksis. Failure means that the Skeksis and their robot-like killers, the Garthim, will control the world forever. Success means both the end of their rule and a return to peaceful harmony in the world of the Gelfling and Pod people. If Jen succeeds, he will live happily ever after with Kira, the female Gelfling, who appears halfway through the game.

Playability:

The game is based on and faithful to the movie of the same name, but having seen the movie is neither a help nor a hindrance when playing the game. The graphics, although having large expanses of white, are beautifully detailed. Lighthearted and fun to play, the game anticipates your actions and commands. Easy enough for beginners and captivating enough for more experienced players.

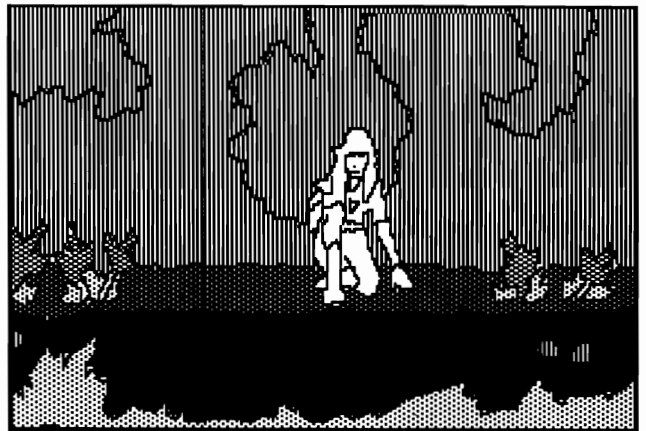
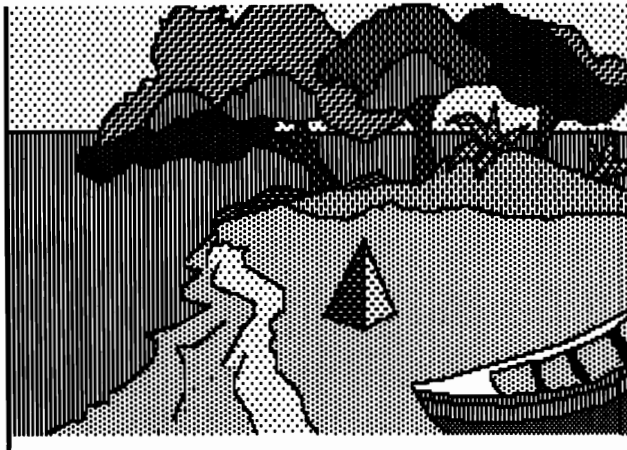

DARK CRYSTAL

Part 2

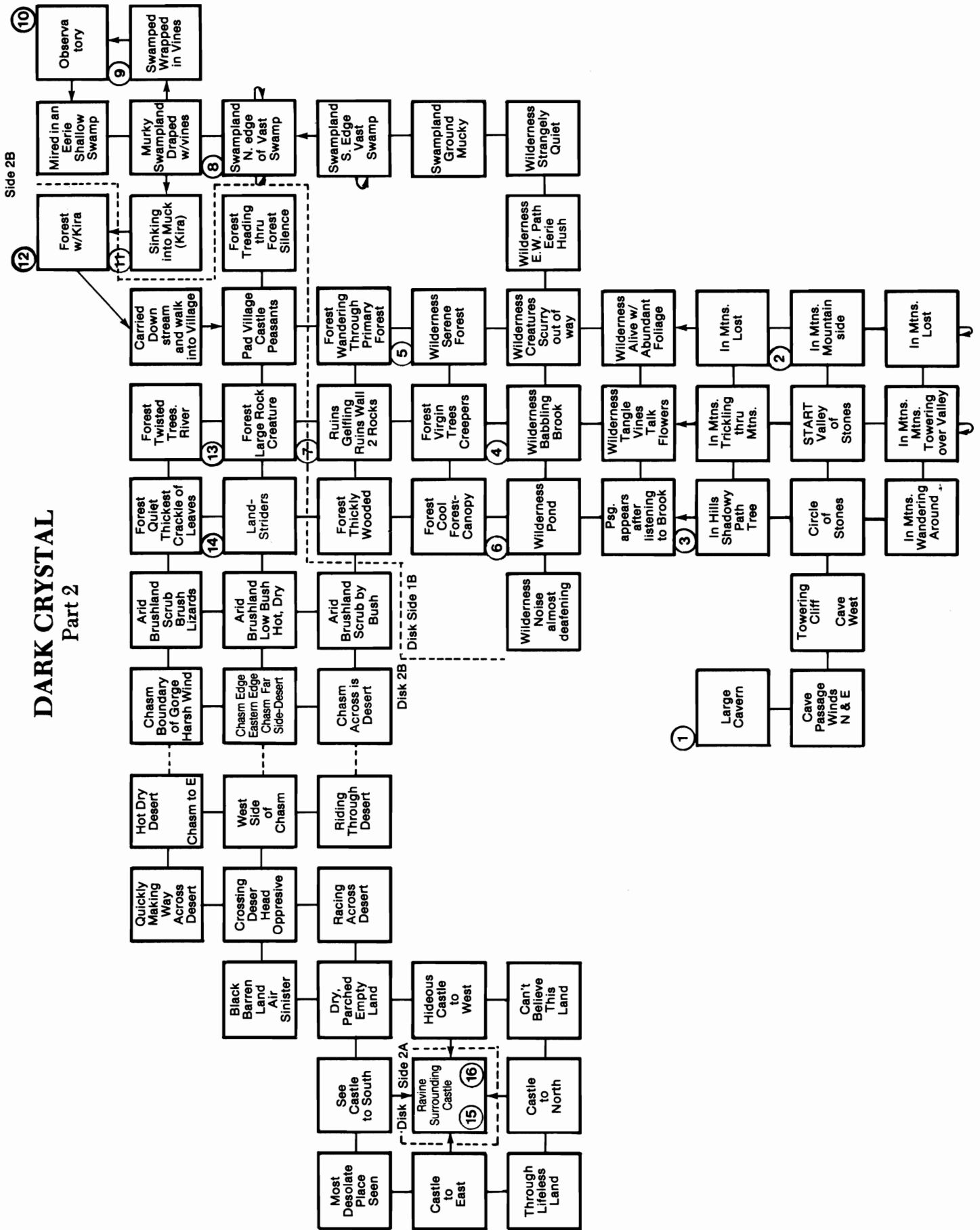

DEADLINE

Company: Infocom, Inc.

Suggested Retail: \$49.95

Type: The first of a series of all-text mystery adventures.

Description:

You, the Detective, are called upon to investigate the apparent suicide of a wealthy and philanthropic industrialist. You encounter no monsters or wizards, just seven characters you can talk to, question, or watch as they move about independently. You have twelve hours to unravel the mystery and arrest one or more of the four principal suspects. You will have to prove motive, opportunity, and means. There are twenty-five possible endings, ranging from dismissal by the Grand Jury to conviction by the Trial Jury. Some endings come with shocking suddenness; others give you clues for your next attempt at solving the mystery.

Playability:

Totally engrossing. You feel as if pulled directly through the CRT and right into the mansion with the suspects. While the game offers a moderate difficulty level and number of puzzles, the convoluted puzzles demand interaction and one of them proves quite tough. This game requires considerably more deductive logic than adventures usually call for.

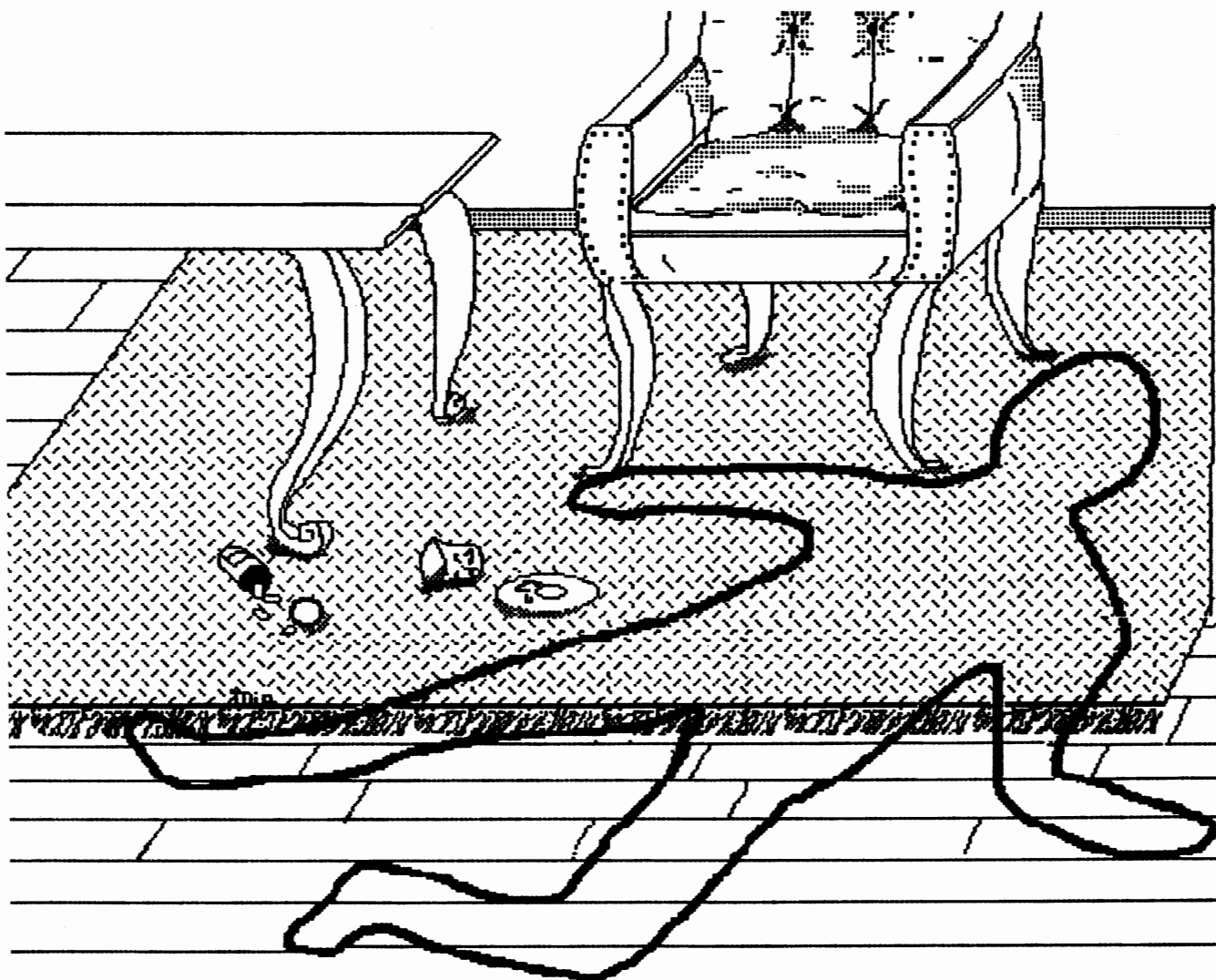

DEADLINE

Outside House

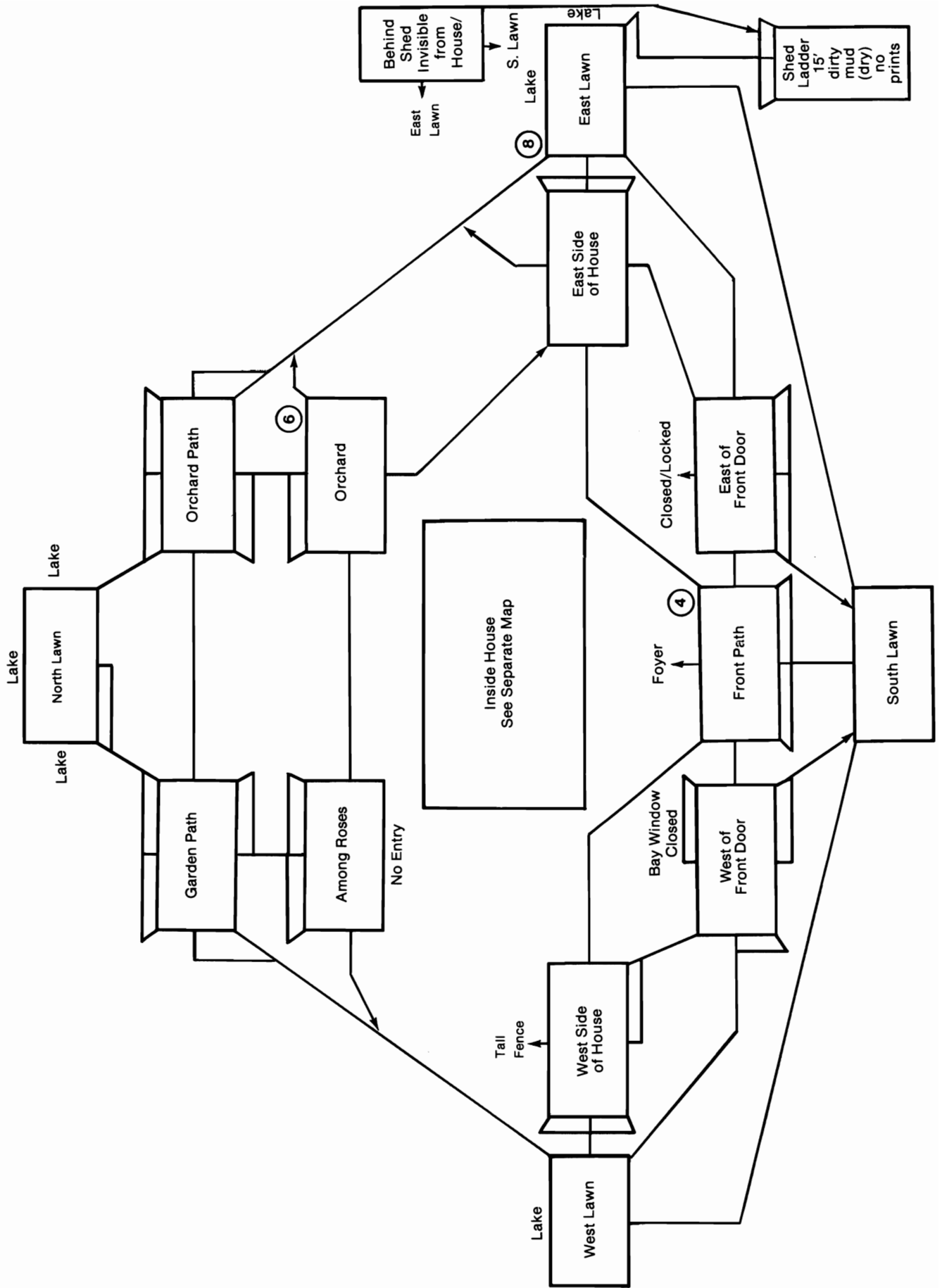

DEADLINE

Inside House

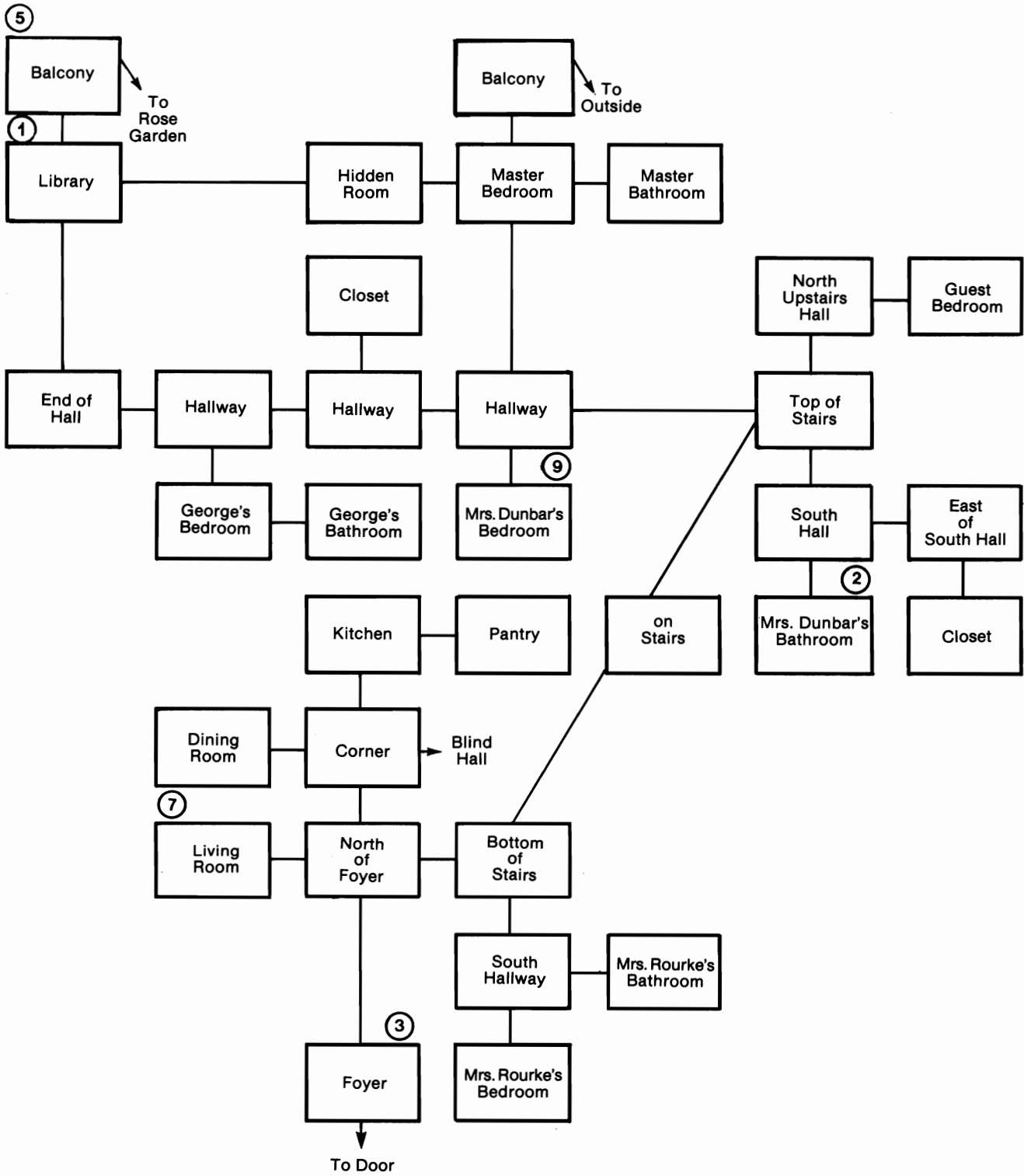

DEATH IN THE CARIBBEAN

Company: Micro Lab

Suggested Retail: \$35.00

Type: Hi-Res adventure with color graphics.

Description:

You find yourself on an enchanting but dangerous Caribbean island, divided by a fast flowing river. You've come in search of buried treasure. Yes, it's here, but it will take a bit of doing as well as digging to get it. The graphics are very well done, sharply detailed and quick to fill. The puzzles offer moderate difficulty; some—in a sense—involve a play on words.

Playability:

A good, solid adventure. A little thin on the story-line and text, but nevertheless challenging. Playability would improve greatly if the game supported dual disk drives; as it stands, with two program sides you quite often find yourself flipping disks like hot cakes! The two-word parser has a limited vocabulary. Fortunately, the negatives are well balanced by some of the best red-herring puzzles yet encountered, some helpful magic, and a little cryptology.

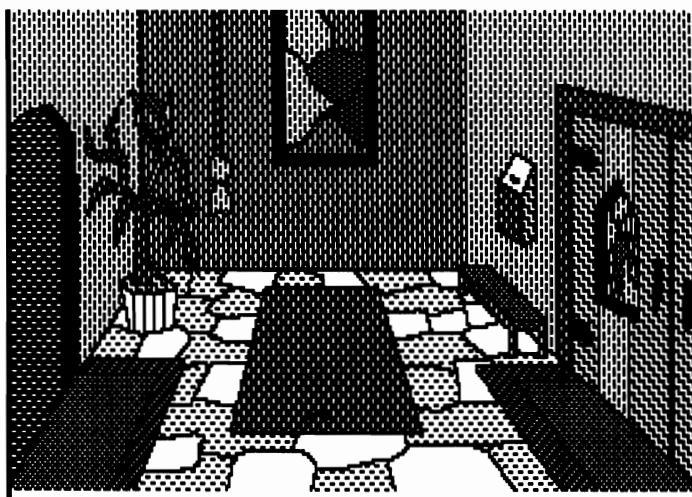

DEATH IN THE CARIBBEAN
Part 2

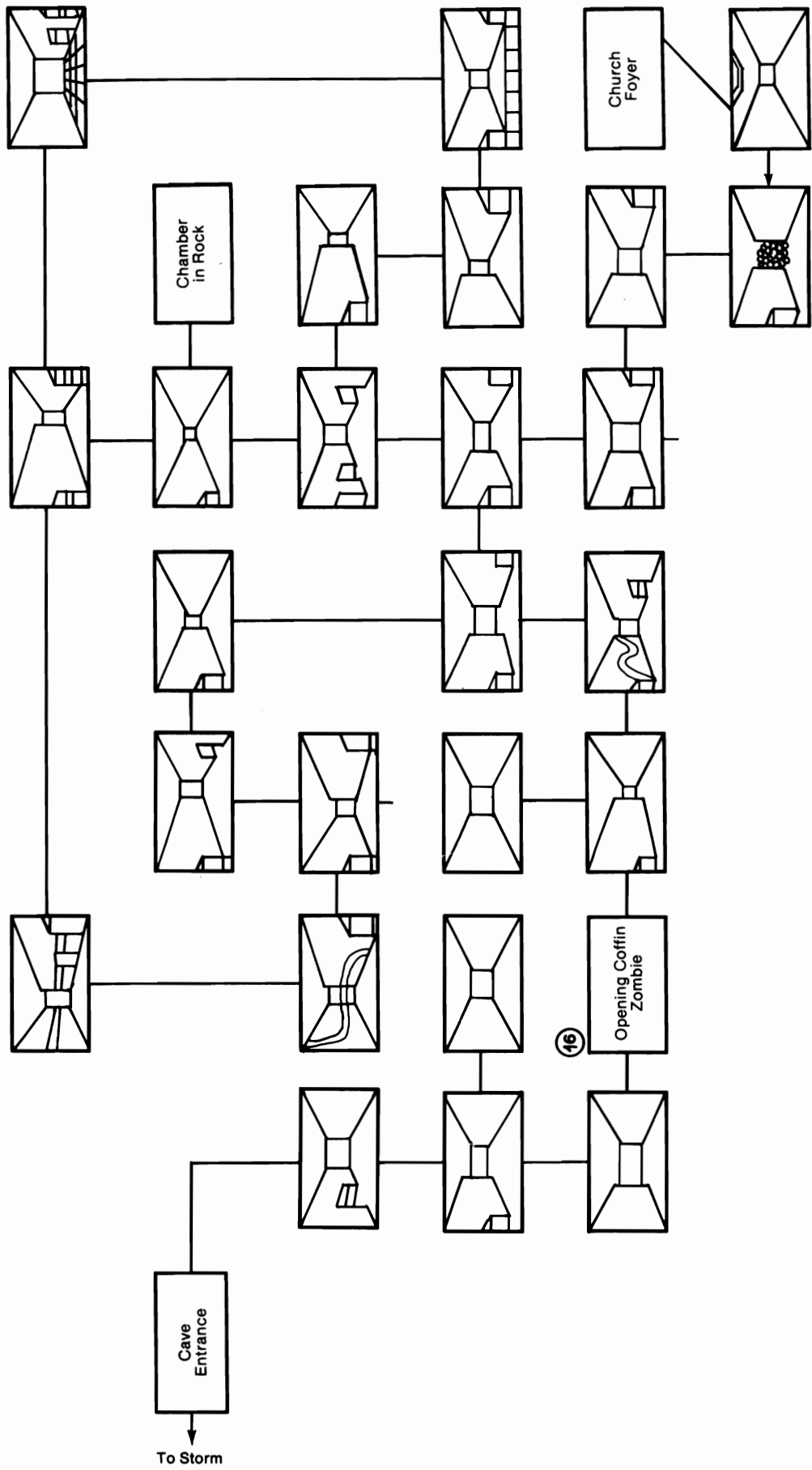

DEMON'S FORGE

Company: Saber Software

Suggested Retail: \$39.95

Type: Hi-Res adventure with color graphics.

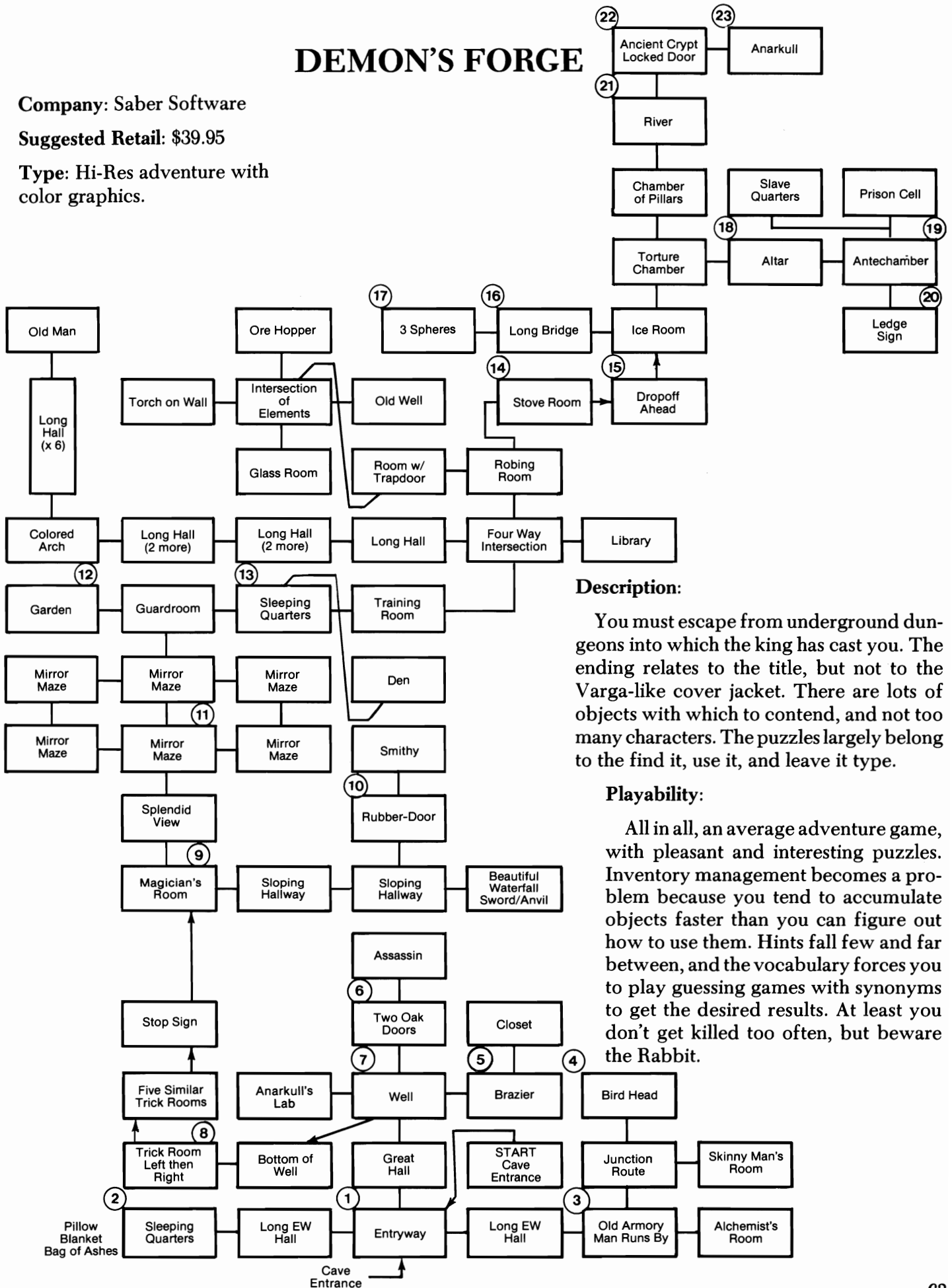

Description:

You must escape from underground dungeons into which the king has cast you. The ending relates to the title, but not to the Varga-like cover jacket. There are lots of objects with which to contend, and not too many characters. The puzzles largely belong to the find it, use it, and leave it type.

Playability:

All in all, an average adventure game, with pleasant and interesting puzzles. Inventory management becomes a problem because you tend to accumulate objects faster than you can figure out how to use them. Hints fall few and far between, and the vocabulary forces you to play guessing games with synonyms to get the desired results. At least you don't get killed too often, but beware the Rabbit.

DOOM VALLEY

Company: Superior Software, Inc.

Suggested Retail: \$19.95

Type: All-text adventure.

Description:

While vacationing at a ski lodge, you hear that a planeload of UN ambassadors has crashed nearby and can't be found. You later find that, for unknown reasons, equally unknown parties have chained these worthies in a medieval castle located in a steamy jungle populated by lions, tigers, and mambas who pay no attention to you. You win when you return the ambassadors to the ski lodge.

Playability:

So-so at best. Most of the game locations have no bearing on the game. You can win the game in less than four minutes once you know what it requires. The two-word parser demands specific two-word responses, usually self-evident. No real challenge, even to a beginner.



EARTHQUAKE—SAN FRANCISCO, 1906

Company: Adventure International

Suggested Retail: \$39.95

Type: Hi-Res adventure using color graphics.

Description:

A note for you in your San Francisco hotel tells you to deliver a ransom (conveniently on the dresser) to a specific hotel or you'll never see your wife again. This simple task is suddenly complicated by your room collapsing around your ears, chaos in the streets, fallen buildings, trigger-happy and not-too-honest soldiers, the need to become a hero, paddling around Oakland Bay, and getting piddled on by a small dog.

Playability:

A lot of backtracking takes place because things at earlier locations change when you meet conditions set later in the game. Some mildly interactive puzzles, but for the most part you must solve them in sequence, which slows down the game. The speed of the game, vocabulary, parser, and text all leave a lot to be desired, but attractive graphics, several intriguing puzzles, and an interesting storyline make the game worthwhile.

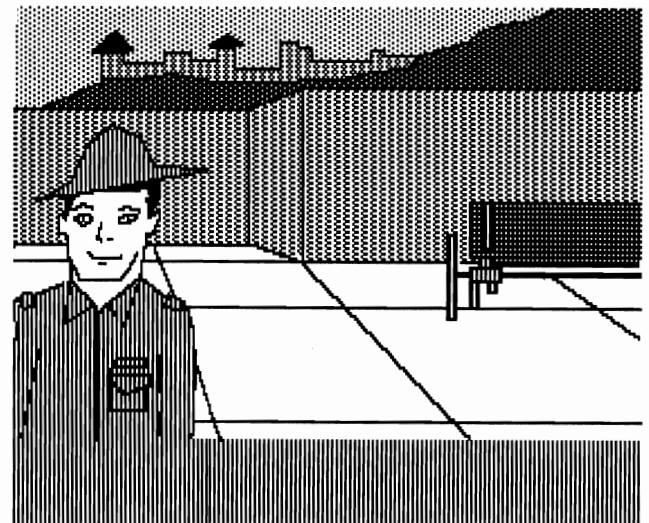
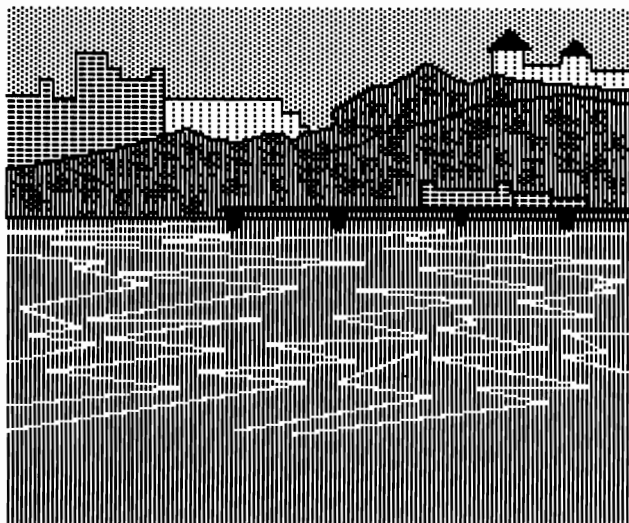
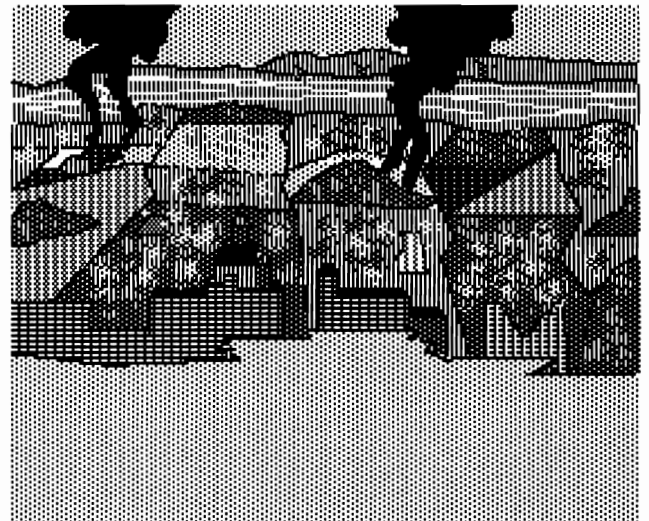
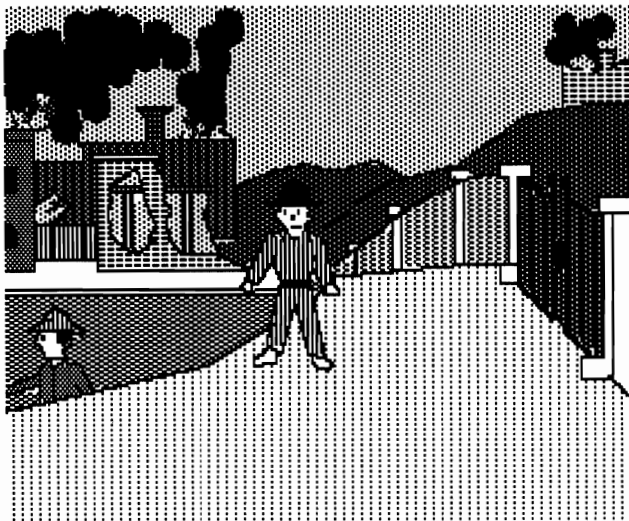

EARTHQUAKE—SAN FRANCISCO, 1906

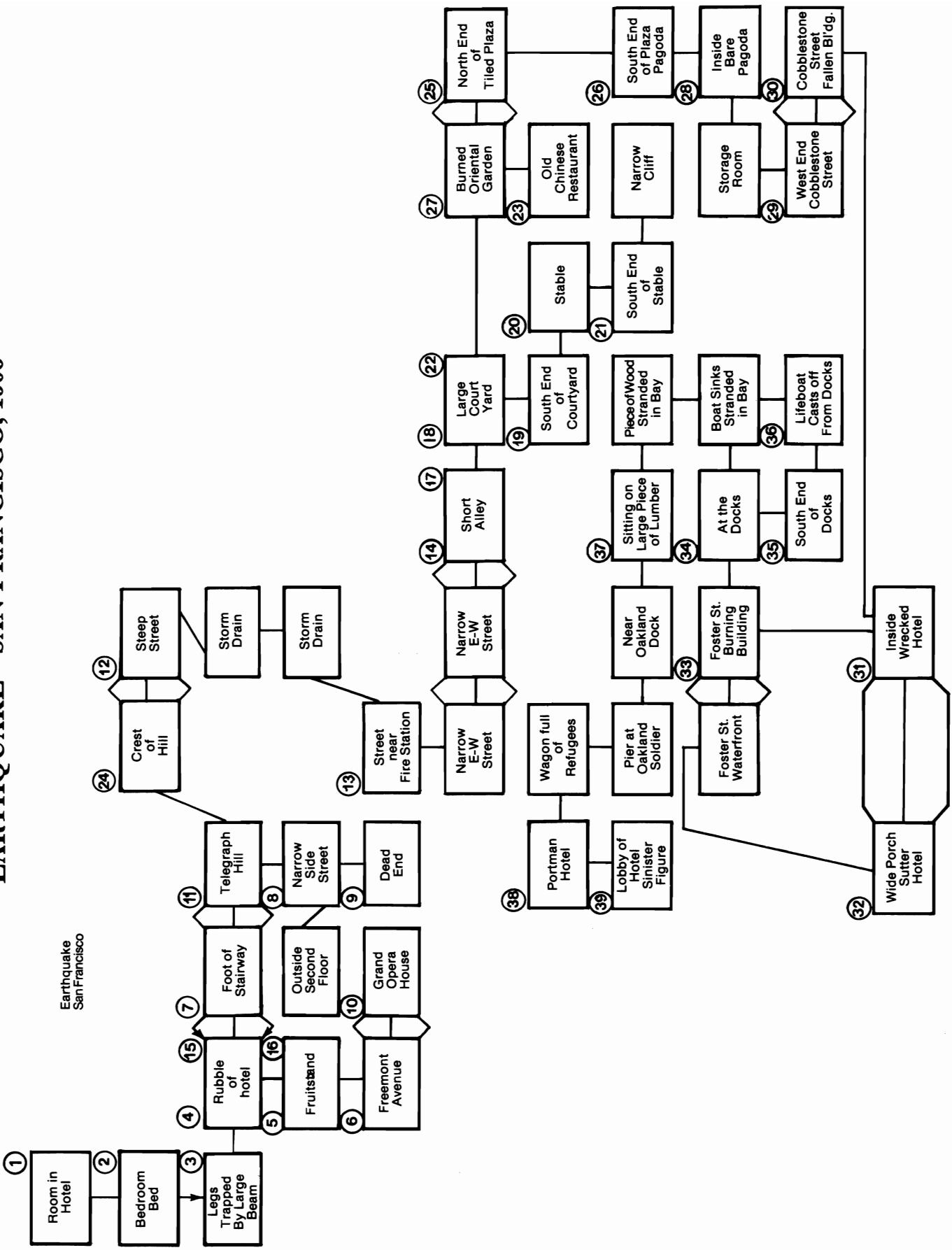

Blue Planet

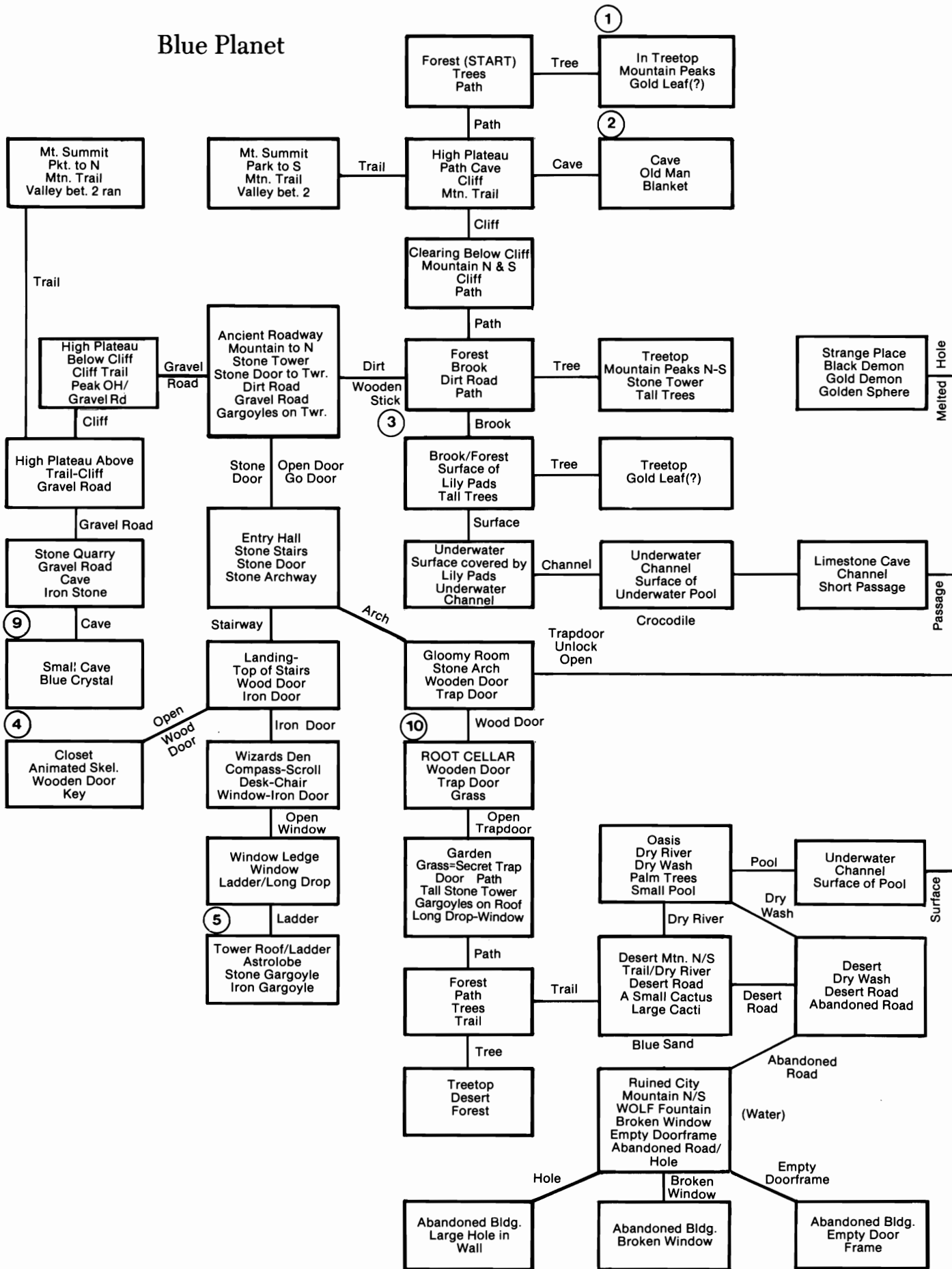

EMPIRE OF THE OVERMIND

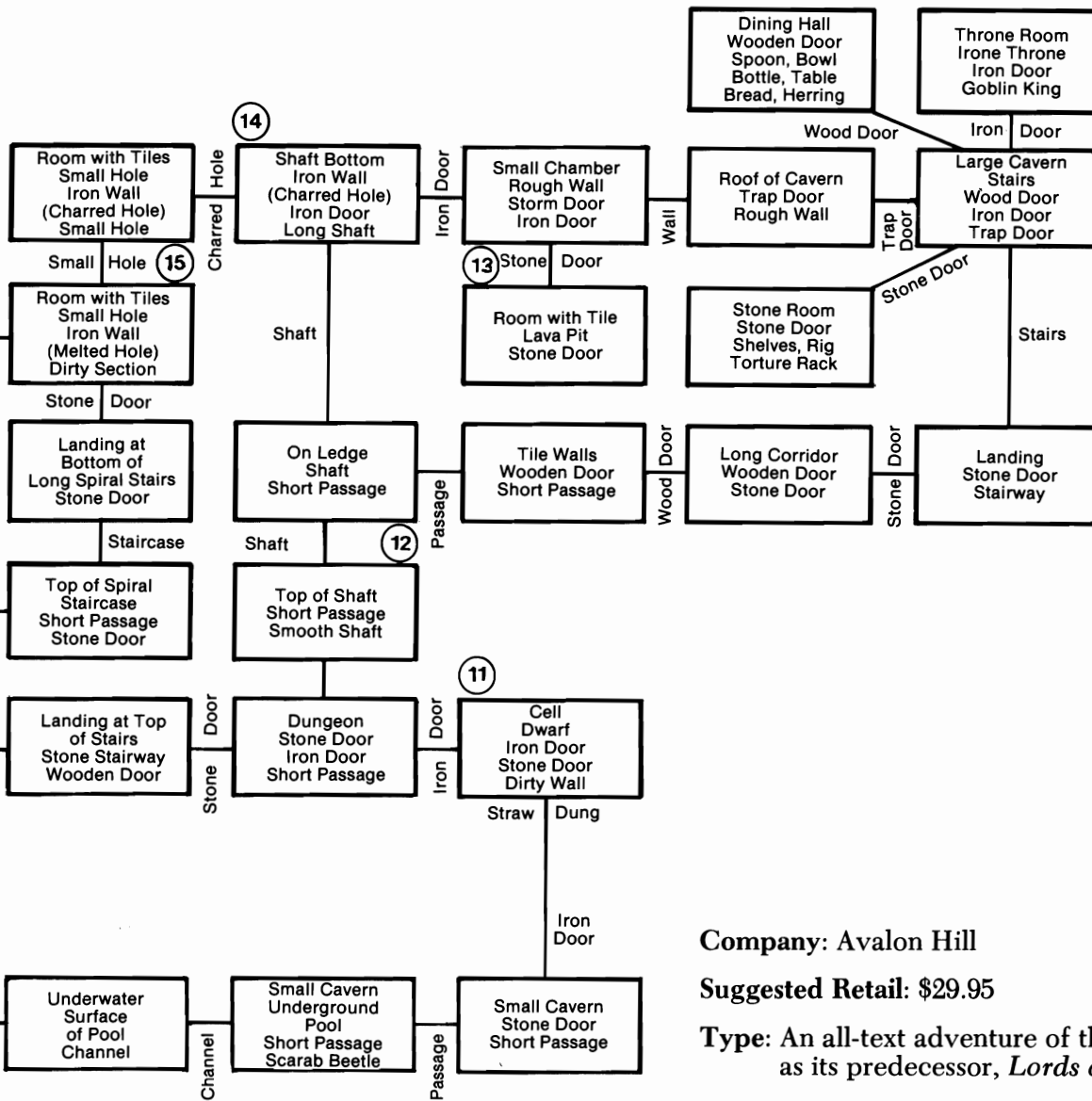

Company: Avalon Hill

Suggested Retail: \$29.95

Type: An all-text adventure of the same genre as its predecessor, *Lords of Karma*.

Description:

You must find and destroy the Overmind (a golden sphere) to win the love of the enchanted Princess whom you meet while trying to cope with the game's sundry critters and traps. The game abounds with many objects, a helpful dwarf, and some useful magical items. It's a toughie.

Playability:

Engagingly difficult but agonizingly slow, especially for an Assembly language program. The documentation gives the history and game objective in verse, but does not describe how to save or restore a game. You should read it carefully. Unfortunately, you cannot solve the game without the save and restore. Try Reset: Call-151: BSAVE (filename), A\$8000, L\$1000. To restore, use Reset: Blond (filename): Call-151: 800 G. Despite its obvious weaknesses, it's a very tough and challenging game.

EMPIRE OF THE OVMIND

Red Planet

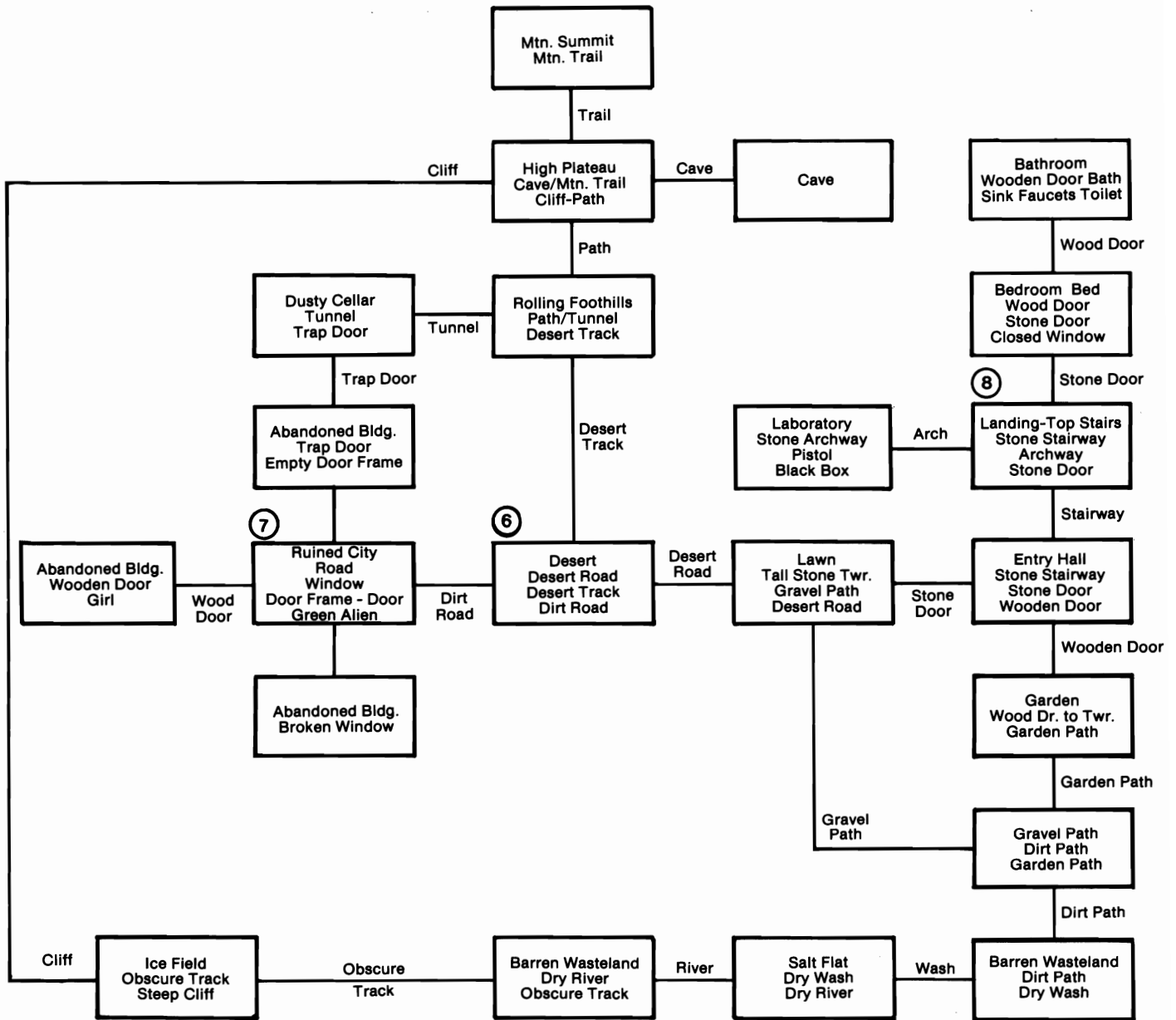

ENCHANTER

Company: Infocom Inc.

Suggested Retail: \$49.95

Type: An all-text adventure.

Description:

Zork lives, embodied here in the descriptions and puzzles accorded to you as the neophyte wizard, charged by your wizened mentor, Belboz, to seek and destroy the great evil wizard, Krill. Only an innocent fledgling can hope to succeed in this quest due to Krill's precognitive powers. It's tough to find some of the thirteen scrolls you'll need to achieve this goal. Find out what it's like to get sacrificed, and talk with frogs, turtles, and a shaggy adventurer.

Playability:

The game plays easily and smoothly and employs the excellent parser, vocabulary, and two-drive save-game capability that mark Infocom games. Lots of fun to play, with well anticipated wise remarks made to many inputs.

Enchanter



ENCHANTER

Part I

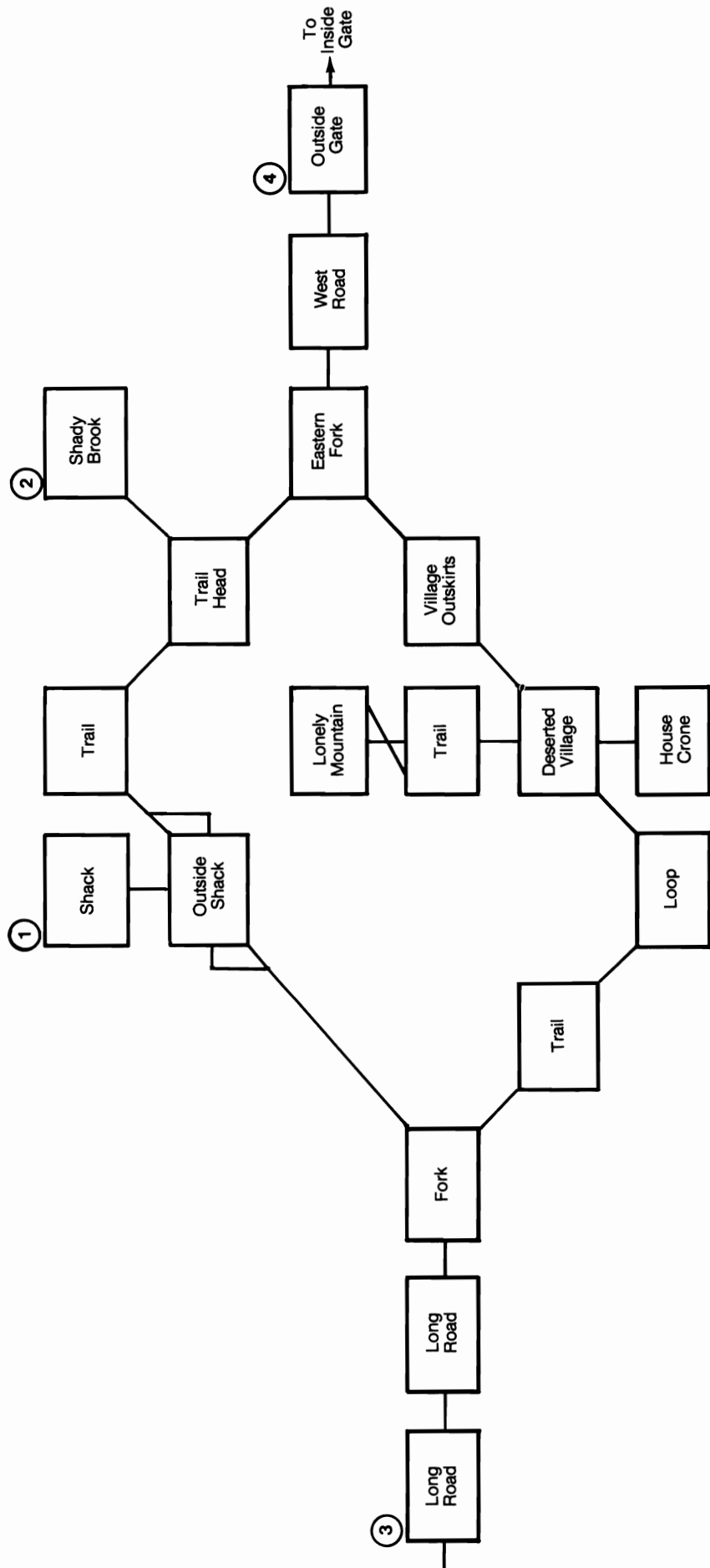

ENCHANTER

Part 2

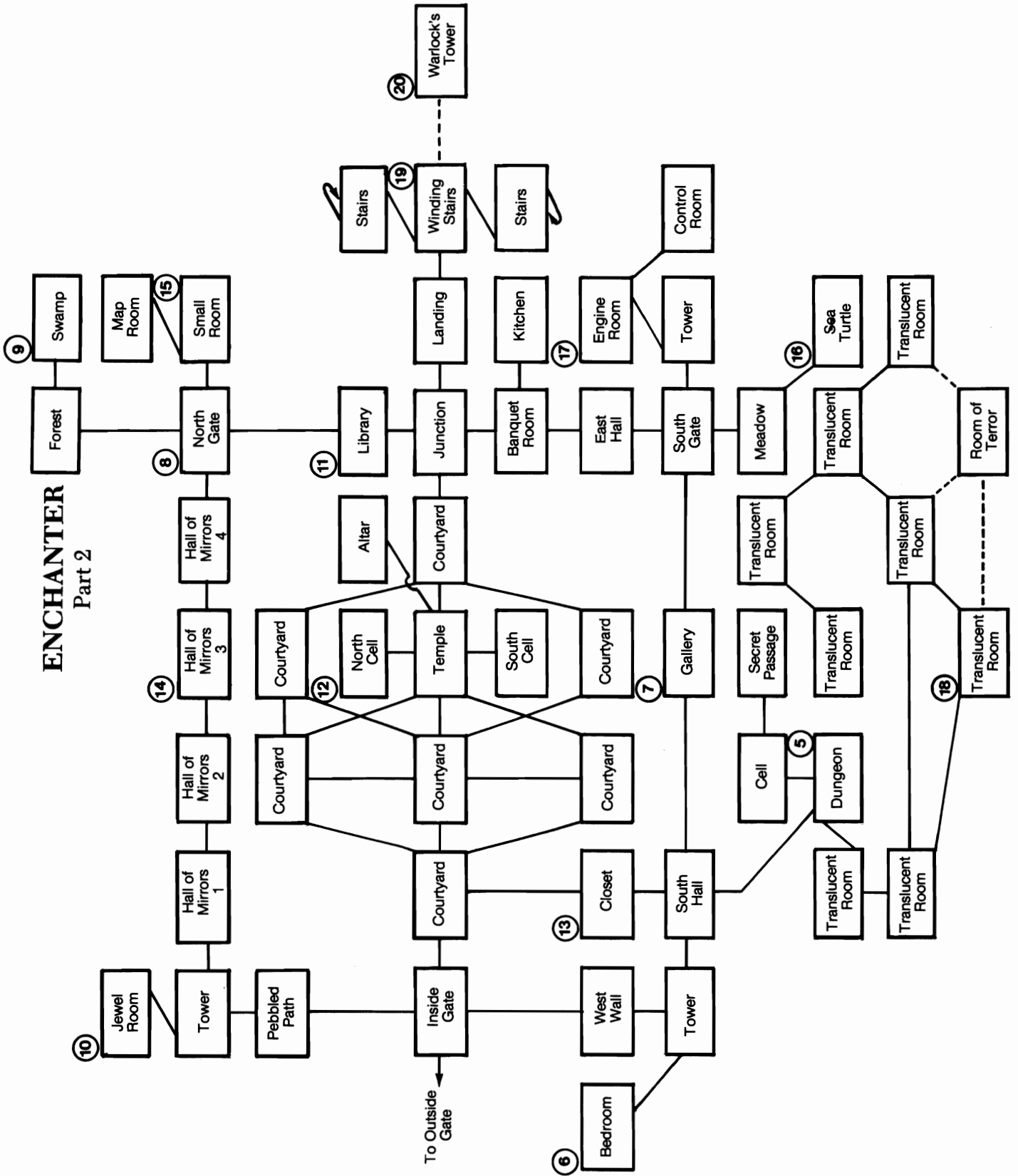

ESCAPE FROM RUNGISTAN

Company: Sirius Software, Inc.

Suggested Retail: \$29.95

Type: A black and white Hi-Res adventure that includes some arcade-like action.

Description:

You must escape from your prison cell and cross the border of dictator-ruled Rungistan into the safety of Nuggyland. Natch, you are pursued by the Rungistanees, who must see to it that you are shot in the morning—or they get scheduled to lose their own hides.

Playability:

An average adventure in all regards, with much lacking in many regards. One nice feature: the screen fill takes place crisply and quickly. Often, you get one shot at the correct answer before bad things happen to you! Generally, you must solve puzzles in order before you can go on to the next location, which slows the game. The arcade section challenges you to ski between seven or so sets of rapidly approaching trees. Prior to saying “Geronimo,” use the single save-game feature back to the program disk.

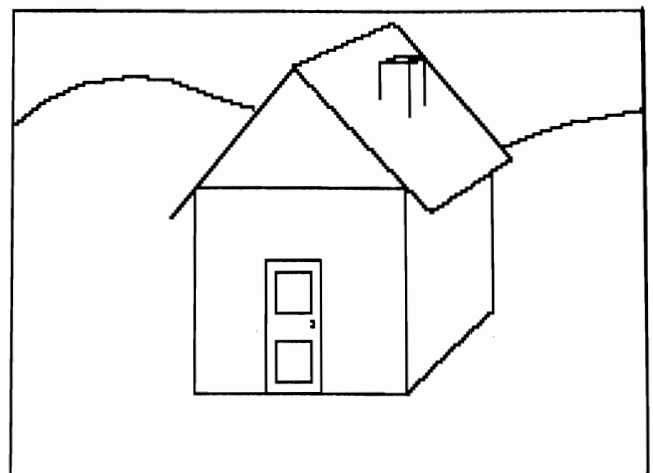
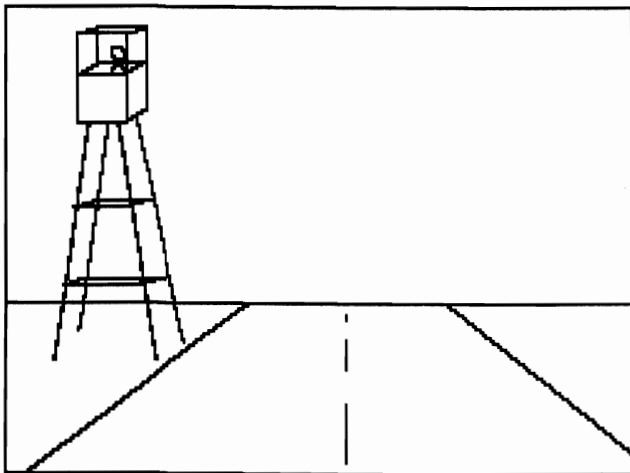

ESCAPE FROM TRAAM

Company: Adventure International

Suggested Retail: \$34.95

Type: Hi-Res adventure with color graphics.

Description:

Your spaceship crashes into the planet of Traam, but somehow you survive. Armed with only your wits, you must find the means to escape this desolate land. Enroute to finding another spaceship in which to return to your mothership, you encounter an alien warrior, a friendly little creature, some Traam slaves, and troops of ferocious Traams. You must become something of a linguist to understand some of what you see or hear.

Playability:

This game shares the shortcomings of *Earthquake—San Francisco, 1906*, but has few of its virtues. The puzzles are semi-logical in spots, and seem disjointed and rather unrelated, although for the most part they occur in sequence. You can make a single saved-game position to the program disk; a few more saves would help.

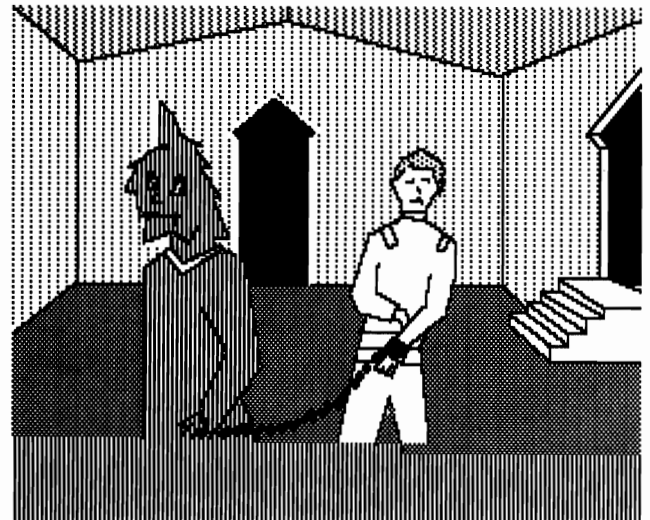
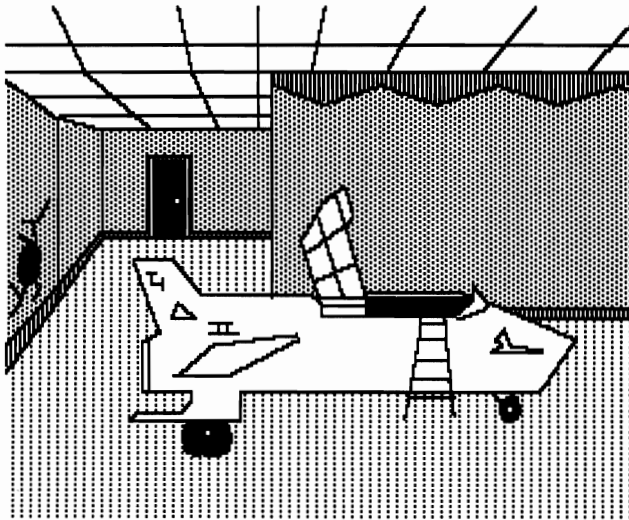

ESCAPE FROM TRAAM

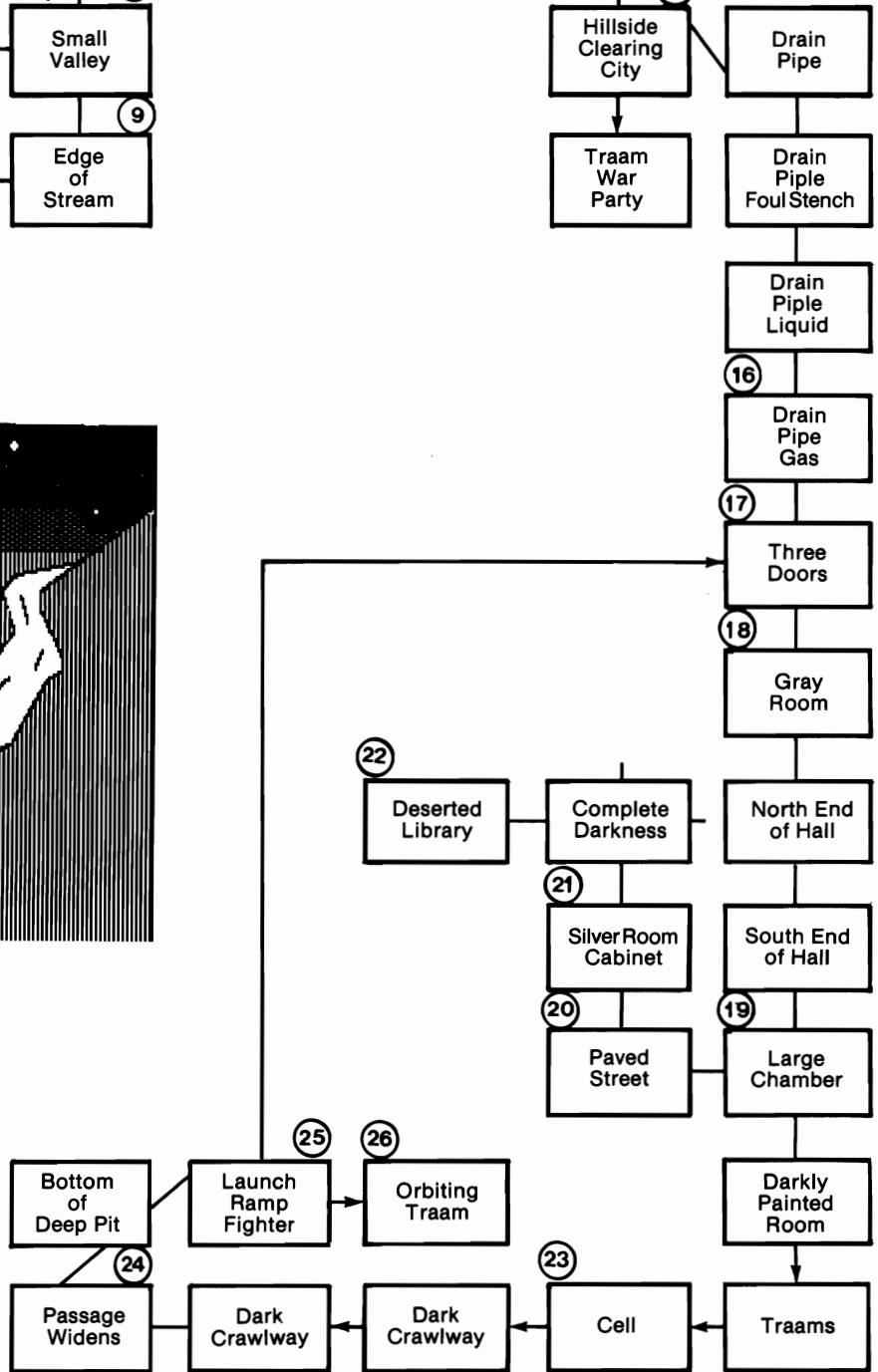
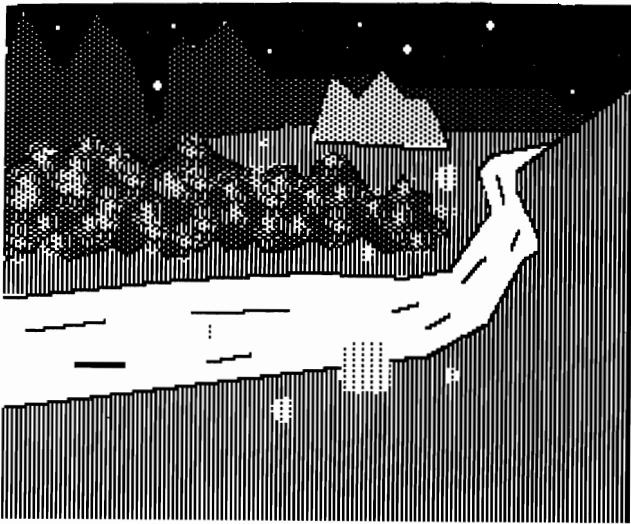
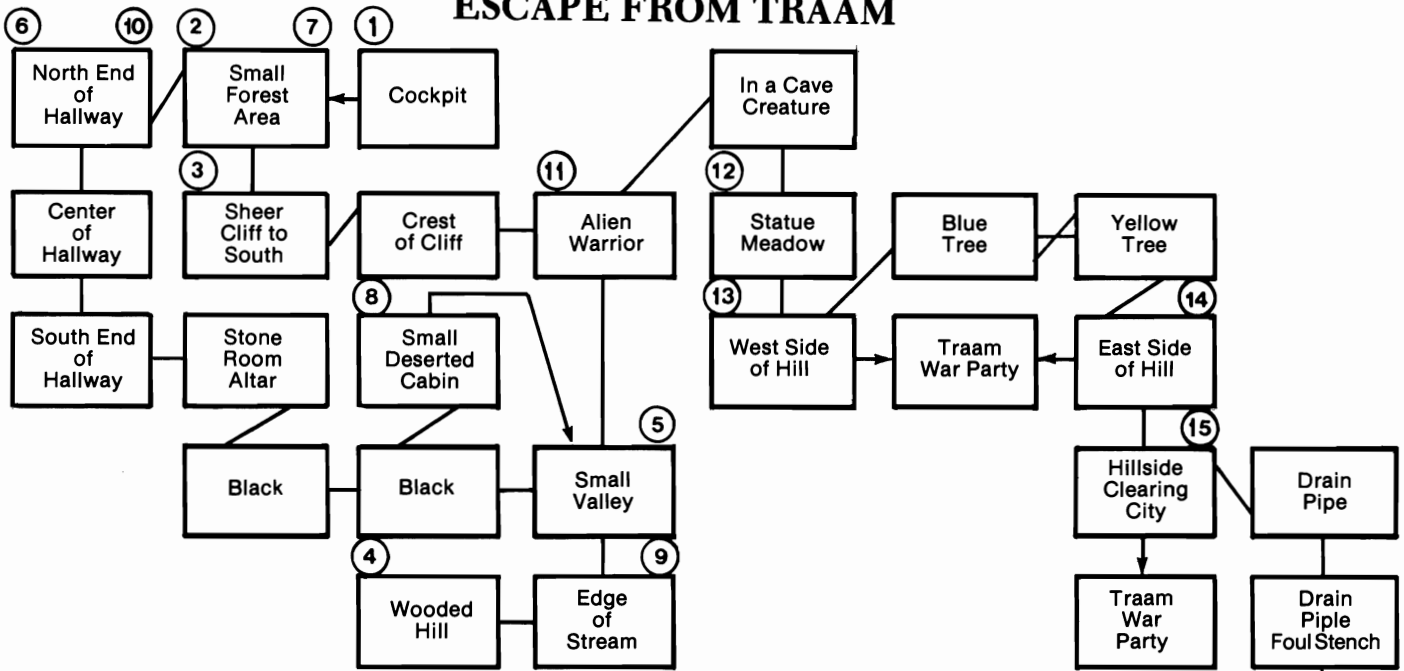

FANTASYLAND, 2041 AD

Company: Crystal Software

Suggested Retail: \$49.95

Type: Hi-Res fantasy adventure.

Description:

This game requires no solution, nor has one been provided. Your task, easy enough to say, proves long and difficult to do—simply find Guinevere or Lancelot. Trek through the six disk-sides and the game's six different lands, acquiring the men, material, supplies and magical items that you need. Other than finding out which objects to use on what, you face no real puzzles in this bit of escapism. However, the concept of the game is well done, with nice shape-tabled graphics interspersed with attractive Hi-Res displays.

Playability:

Nice ideas, led astray by absolutely horrid implementation. Sad to say, this game abounds with bugs, many of them fatal programming errors. The biggest puzzle, it seems, is to find which events and sequences you should stay away from. While repetitious, it's sort of fun; too bad it's loaded with syntax errors and fundamental programming errors.



CONGOLAND Side 1

Swamp	Swamp	Swamp	Swamp			Temple (Shrunken Head)	
Swamp	Swamp	Swamp	Mountain				
Mountains	Swamps	Swamps	Swamps	Mountains	Mountain (Psgs.)		
Mountain	Mountain	Mountain	Mountains	Mountain	Mountain (E-W Psg.)	Banana Groves	Banana Groves
Jungle	Jungle	Jungle	Jungle	Jungle	Water Fall	River II	Trading Post
Jungle	Jungle	Jungle	Jungle	Jungle	Jungle	River III	River IV
Crabs	Fish	Horses	Jungle	Ant Hills	Jungle	Jungle	Ant Hills
Shields		Skulls	Jungle	Jungle	Jungle	Jungle	Jungle

ARABIA Side 2

Baghdad (Tiger Fang)	Desert	Desert	Oasis	Desert	Desert	Desert	Desert
Desert	Desert	Desert	Mountain	Sand Pits	Desert	Ruins	Desert
Mountain	Mountain	Mountain	Mountain	Sand Pits	Desert	Desert	Desert
Mountain	Desert	Ruins	Desert	Desert	Oasis	Desert	Desert
Oasis	Desert	Desert	Desert	Desert	Desert	Desert	Desert
Desert	Desert	Desert	Desert	Desert	Desert	Desert	Ruins
Desert	Desert	Desert	Desert	Desert	Desert	Desert	Desert
Desert	Desert	Desert	Cathay	Desert	Desert	Desert	Desert

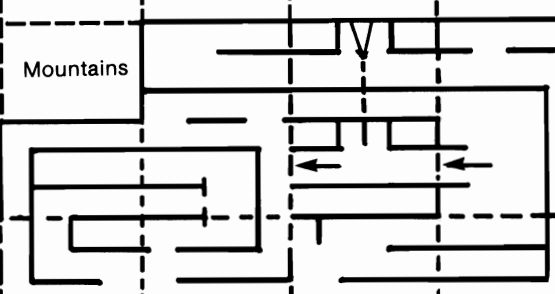
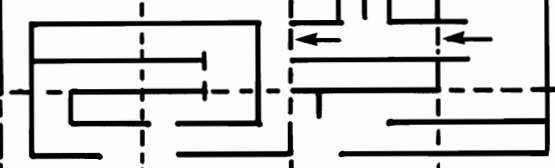
KING ARTHUR Side 3

Camelot	Grassland	Swamp	Swamp	Swamp	Swamp	E Swamp	Swamp
Grassland	Grassland	Swamp	Swamp	Sherwood Forest	Grassland	Grassland	Grassland
Sherwood Forest	Sherwood Forest	Sherwood Forest	Sherwood Forest	Stone-house	Sherwood Forest	Swamp	Swamp
Sherwood Forest	Sherwood Forest	Sherwood Forest	Sherwood Forest	Sherwood Forest (Ring 1)		Swamp	Swamp
Sherwood Forest	Sherwood Forest	Sea of Mist	Sea of Mist	Mountains	Mountains	Grassland (Excalibur)	Mountains
Swamp	Swamp	Sea of Mist	Dragons Lair Excalibur	Mountains			
Swamp	Swamp	Mountains	Mountains				
Swamp	Swamp	Mountains					

Merlin's Hideaway ←

WHIRLPOOL OF HADES Side 4

Grassland	Cyclop's Treasure	Grassland	Grassland	Med. Sea	Med. Sea	Med. Sea	→ Grass land	Grassland	777 Olympus
Ruins	Ruins	Mountains	Grass land ←	Med. Sea	Med. Sea	Med. Sea	Mountains	Mountains	Grassland
Mountains	Mountains	Mountains	Grassland	Med. Sea	Med. Sea	Reefs	Reefs	Reefs	↑ Med. Sea
Reefs	Reefs	^^ ^ Reefs	^ ^ ^ Reefs	~~~~ ~~~~ ~~~~	Med. Sea	Med. Sea	Med. Sea	Med. Sea	Isle of Thieves
Med. Sea	Med. Sea	Med. Sea	Med. Sea	Med. Sea	Med. Sea	Reefs	Reefs	Reefs	Shallows
Shallows	Isle of Delos	^^ ^ Reefs	◎ ?	Shallows	Grassland	Mountains	Mountains	Mountains	Shallows
Shallows	Shallows	Aegean Sea	Aegean Sea	Aegean Sea	Reefs	Shallows	Shallows	Reefs	Reefs
Aegean Sea	Aegean Sea	Aegean Sea	Aegean Sea	Aegean Sea	Aegean Sea	Aegean Sea	Aegean Sea	Aegean Sea	Aegean Sea
Aegean Sea	Aegean Sea	Aegean Sea	∧	Aegean Sea	Aegean Sea	Aegean Sea	Aegean Sea	Aegean Sea	Aegean Sea

CAPTAIN NEMO Side 5

Underwater 600	Underwater 600	Underwater 600	Underwater 400	Underwater 400	Shark Infested Waters 200	Shark Infested Waters 200	Sunken Ship 1000
Atlantis 1000 ○	Underwater 600	Underwater 400	Underwater 400	Underwater 600	Underwater 600	Underwater 600	Underwater 600
Underwater 200	Trench 1000	Underwater 600	Deep Trench 1000	Deep Trench 1000	Deep Trench 1000	Deep Trench 1000	Deep Trench 1000
Borregas Current 1000	Borregas Current 1000	Underwater 400	Shark Infested Waters 200	Reef 200	Reef 200	Reef 200	Underwater 200
Reef 200	Sunken Ship 1000	Underwater 400	Underwater 400	Underwater 400	Underwater 400	Underwater 400	Underwater 400
Underwater 200	Reef 200	Reef 200	Reef 200	Reef 200	Underwater 600	Underwater 1000	Underwater 600
City of Eelmen 1000	Underwater 400	Underwater 200	Underwater 200	Underwater 200	Underwater 200	Underwater 400	Underwater 400
Underwater 400	Underwater 400	Underwater 400	Underwater 200	Cave Entrance 200	Underwater 200	Underwater 400	Underwater 600

DANTE'S INFERNO Side 6

City of Dis	Mtns. of Harmos	Seplecure of Anastus	X X X X X	Pitch Pits	Legion of Demons	Legion of Demons	Demon
Waste-lands	River of Fire	River of Fire	River of Fire	River of Fire	River of Fire	River of Fire	River of Fire
Waste-lands	Circle of Plutus	Wasteland	Brimstone Pits	Wasteland	Wasteland	Legion of Demons	Legion of Demons
Mountains of Hermes	Mountains of Hermes	Wasteland	Circle of Cerebrius	Land of Harpies	Land of Harpies	Waste-lands	Mountains of Hermes
Brimstone Pits	Brimstone Pits	Brimstone Pits	Circle of Minos	Wasteland	Wasteland	Wasteland	Wasteland
Brimstone Pits	Brimstone Pits	Brimstone Pits	Brimstone Pits	Mountains of Hermes	Mountains of Hermes	Wasteland	Wasteland
Limbo	Limbo	Brimstone Pits	Mountains of Hermes	Mountains of Hermes	Legion of Demons	Wasteland	Wasteland
Entrance to Underworld	Limbo	Brimstone Pits	Brimstone Pits	Wasteland	Wasteland	Waste land	Wasteland

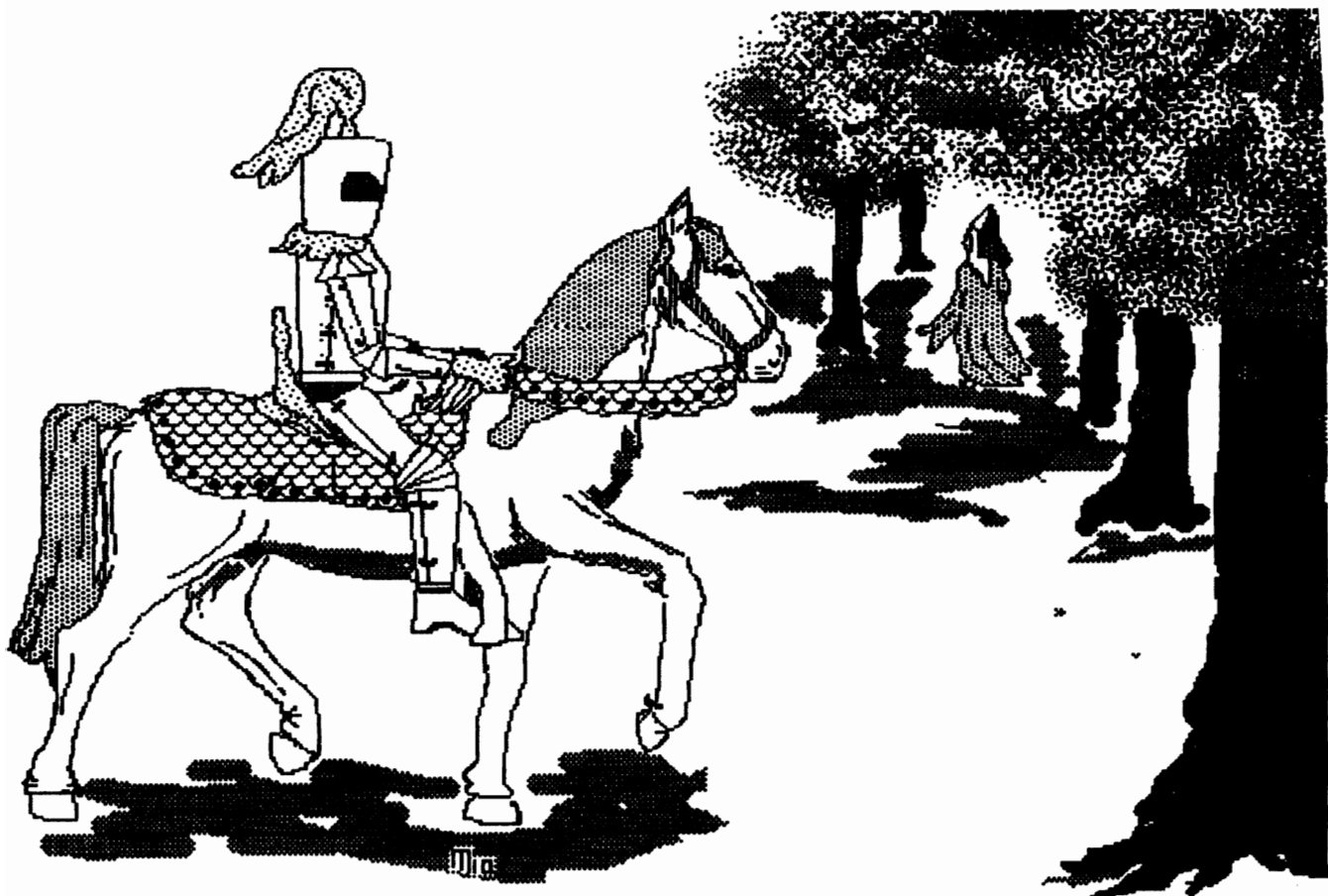

G.F.S. SORCERESS

Company: Avalon Hill

Suggested Retail: \$35.00

Type: An all-text science fiction adventure game.

Description:

The first in the continuing saga of Joe Justin and Selena Sakarov aboard the spaceship G.F.S. Sorceress. This time, they meet in outer space, where Justin has been set adrift in a "regenerating" spacesuit after a trumped-up court martial, to drift alone for the rest of his days. You must make appropriate repairs to the ship before using it to prove Justin's innocence by finding the Red and Black Books on interstellar law.

Playability:

A good story that keeps you glued to the machine to see how everything comes out. However, the game plays painfully slowly and becomes very repetitive in some sequences. Use of the robot involves a rather neat puzzle toward the end of the game.

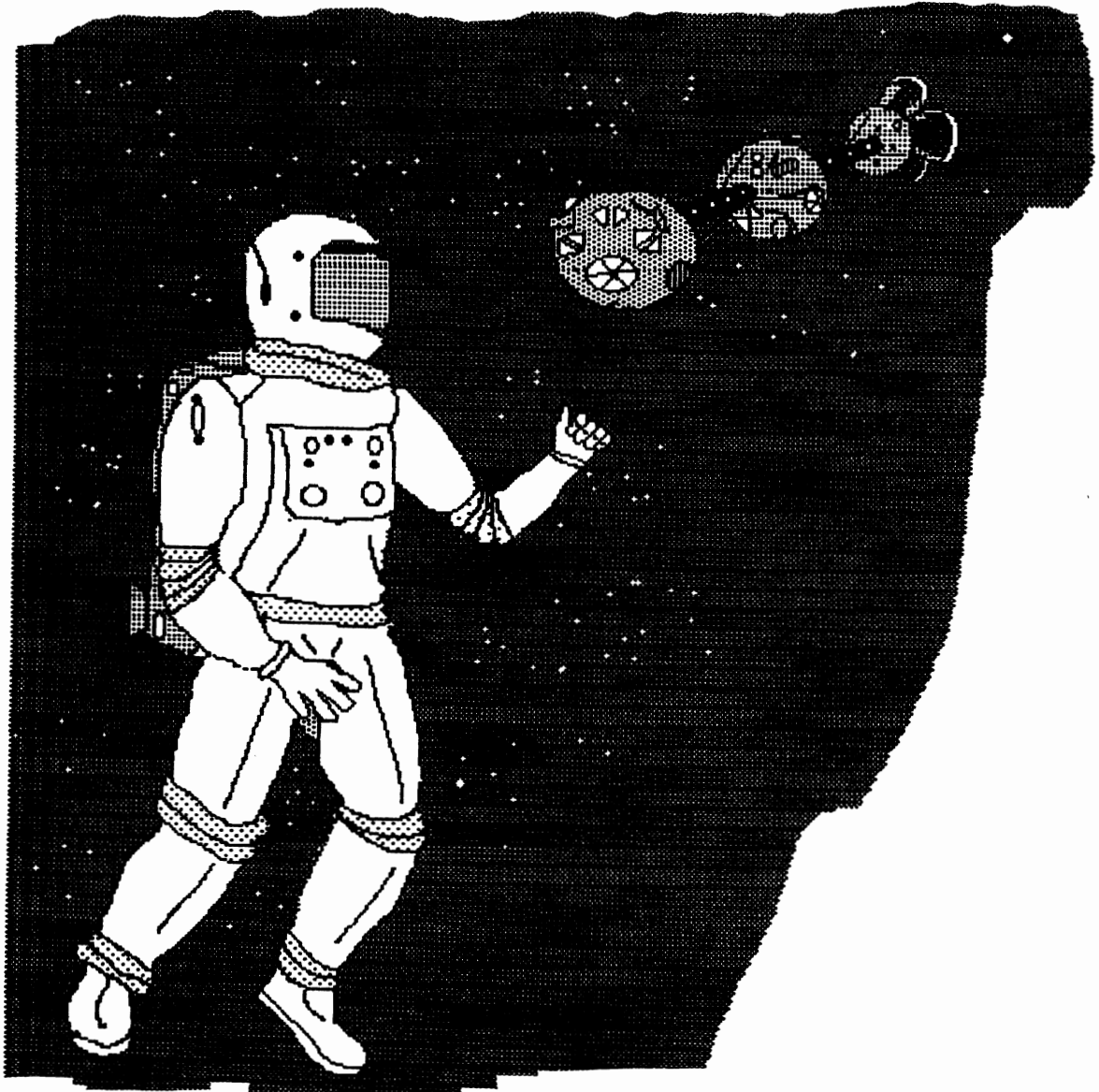

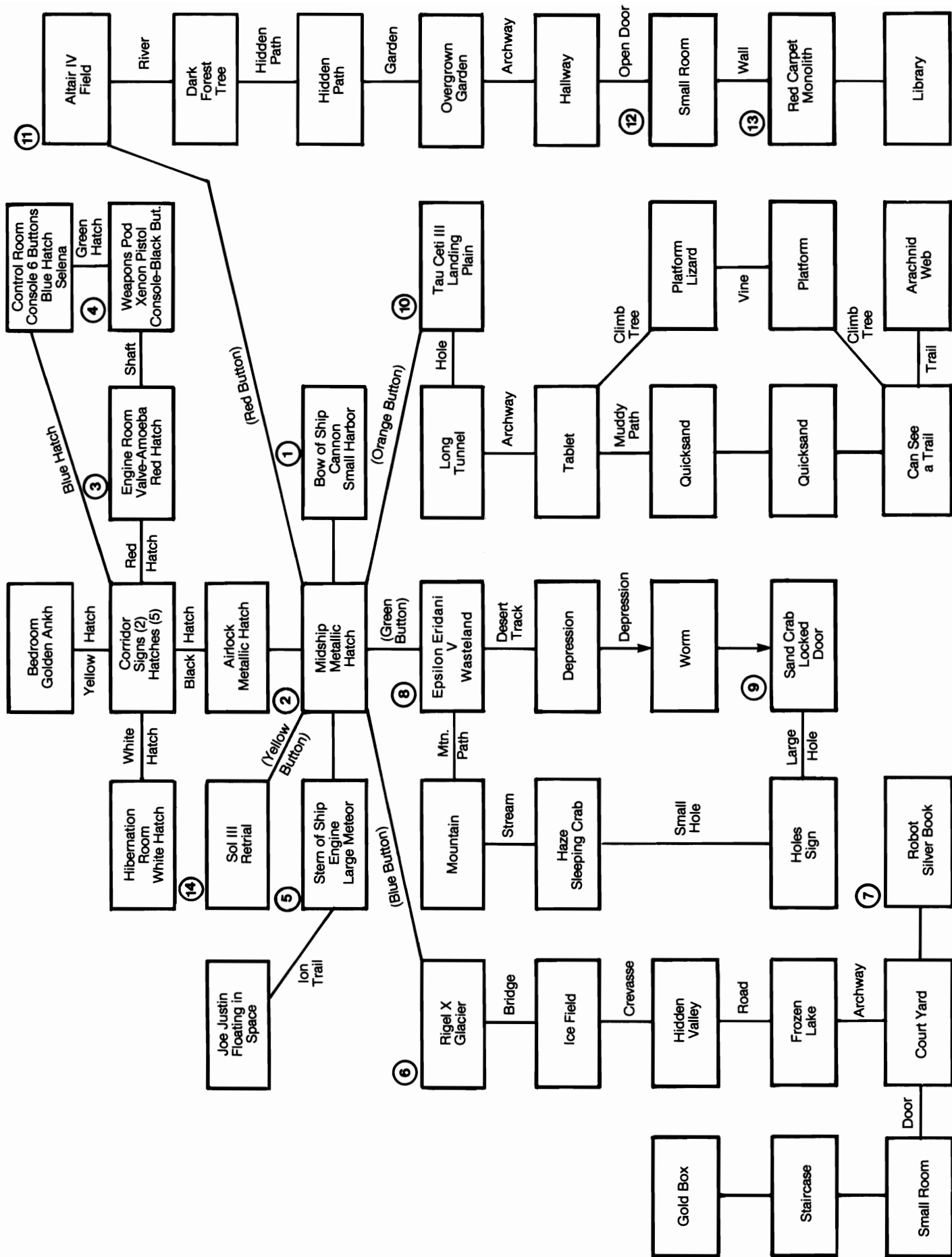

GHOST TOWN

Company: Adventure International

Suggested Retail: \$39.95

Type: An all-text game, scheduled for revision into a Hi-Res version. Price also includes *Mystery Fun House* and *Pyramid of Doom*.

Description:

The locale is an Old West town, complete with saloon, hotel, telegraph stations, a jail, Boot Hill, an Indian, and a piano-playing ghost. Amid this setting lie thirteen treasures which you must find, collect and stash away in the General Store. In a typical Scott Adams' switch, you also get an opportunity for revenge on the Purple Worm.

Playability:

Difficult in spots, and has a game within a game. Once you've solved it, try doing it again. This time try finding the optimum sequence of moves that will earn you the maximum bonus. The two-word syntax has a limited but adequate vocabulary. The text is brief and to the point. The game provides a single, easily made or recalled saved-game.

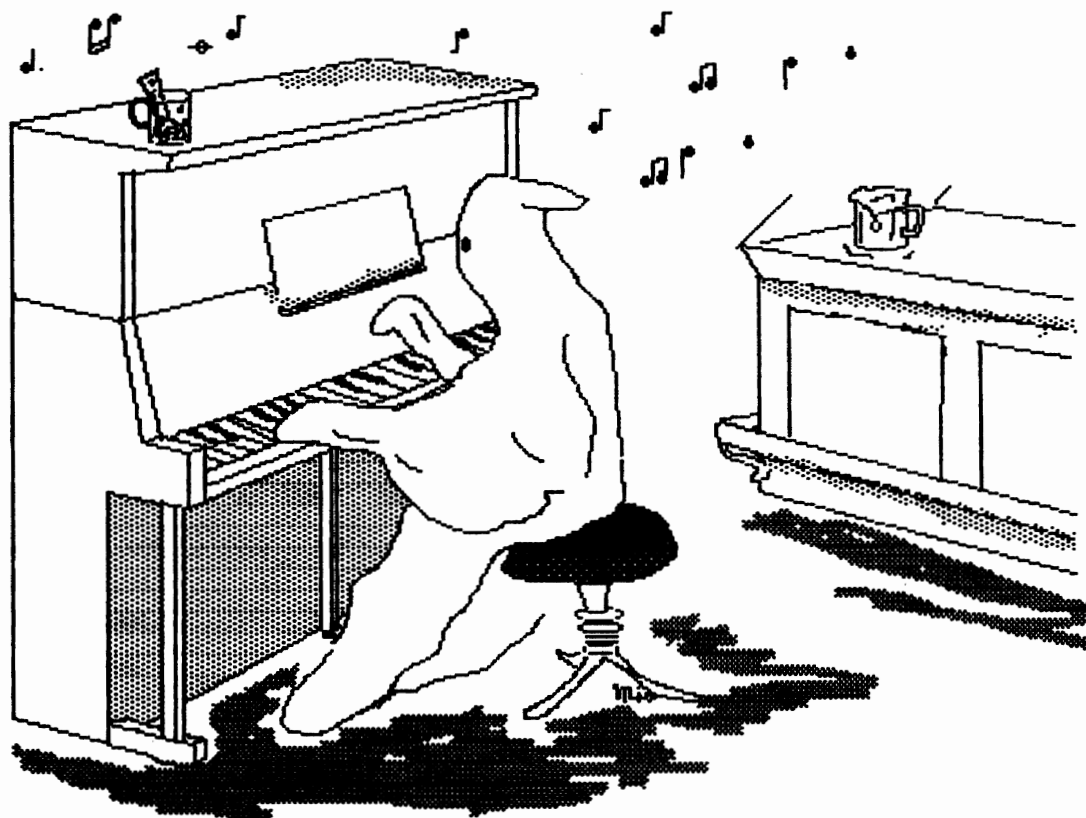

GHOST TOWN

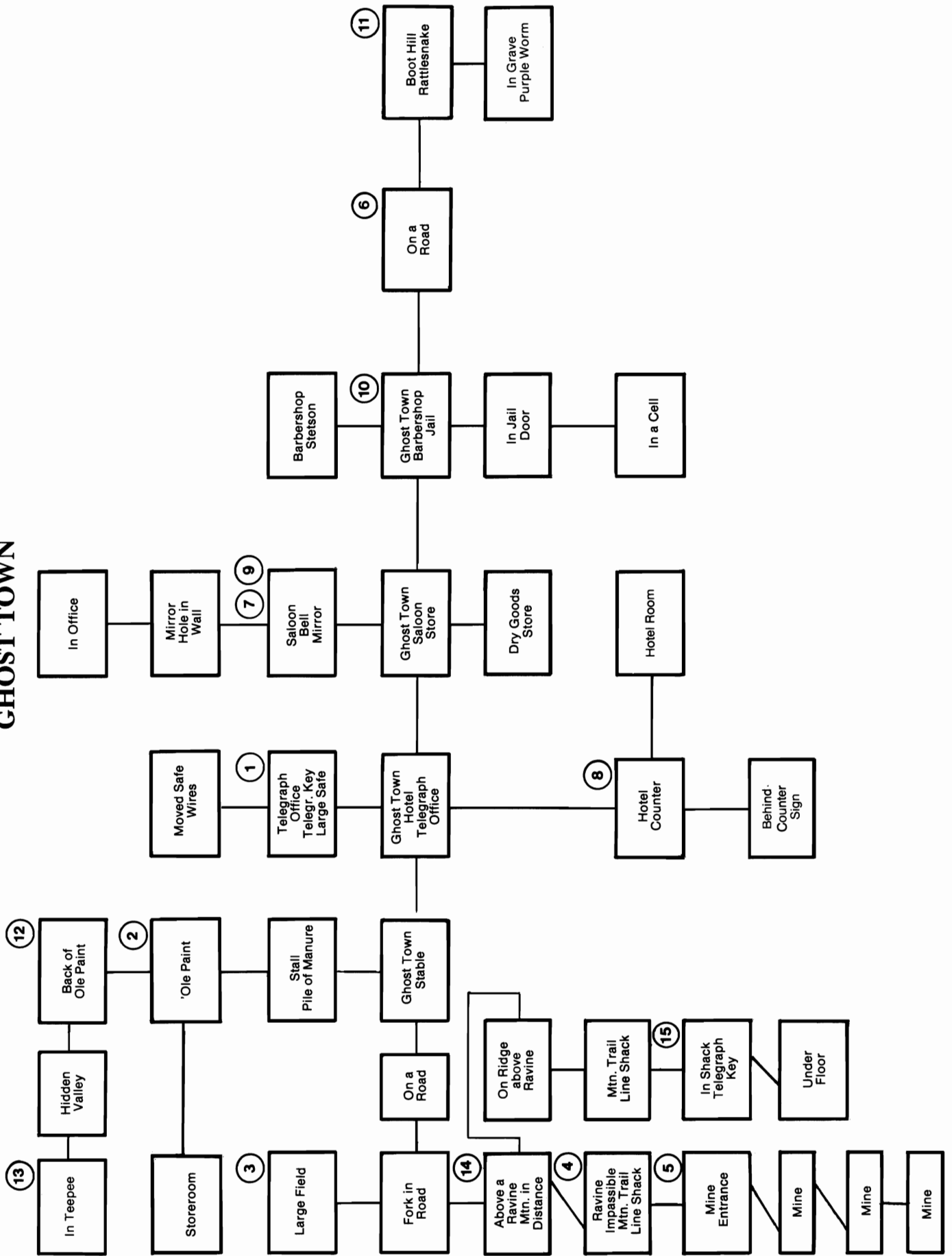

GOLDEN VOYAGE

Company: Adventure International

Suggested Retail: \$39.95

Type: An all-text game, scheduled for revision into a Hi-Res version. Price also includes *Savage Island*, Parts I and II.

Description:

You have three days to find the potion from the fountain of youth required to restore the aged King. To help you accomplish this mission, you receive enough gold to buy various supplies and the snazzy sailing ship needed to shuttle between the three different islands that make up this game. All three islands seem to contain fountains and some magical stones with which you must contend. Then, if you're lucky or clever enough, you get to meet Cyclops!

Playability:

Although the twelfth and last of the original Scott Adams adventures, this isn't one of the harder ones. The degree of difficulty does pick up a bit at the end. The story line is above average, but the relatively slow and jerky nature of the screen display updates indicates that the basic program shell used for these games has just about reached its limits. The two-word syntax has a limited but adequate vocabulary. The text is brief and to the point. The game permits a single easily made or recalled saved-game.

Map Overview

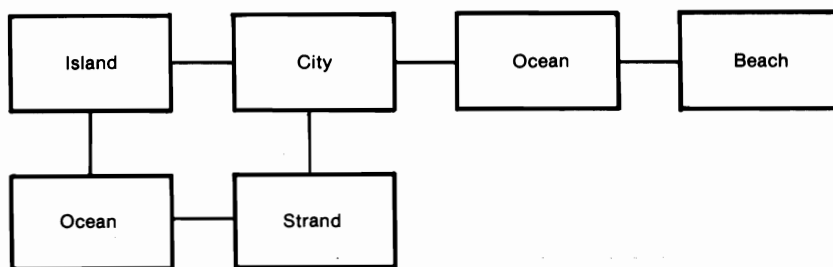

GOLDEN VOYAGE

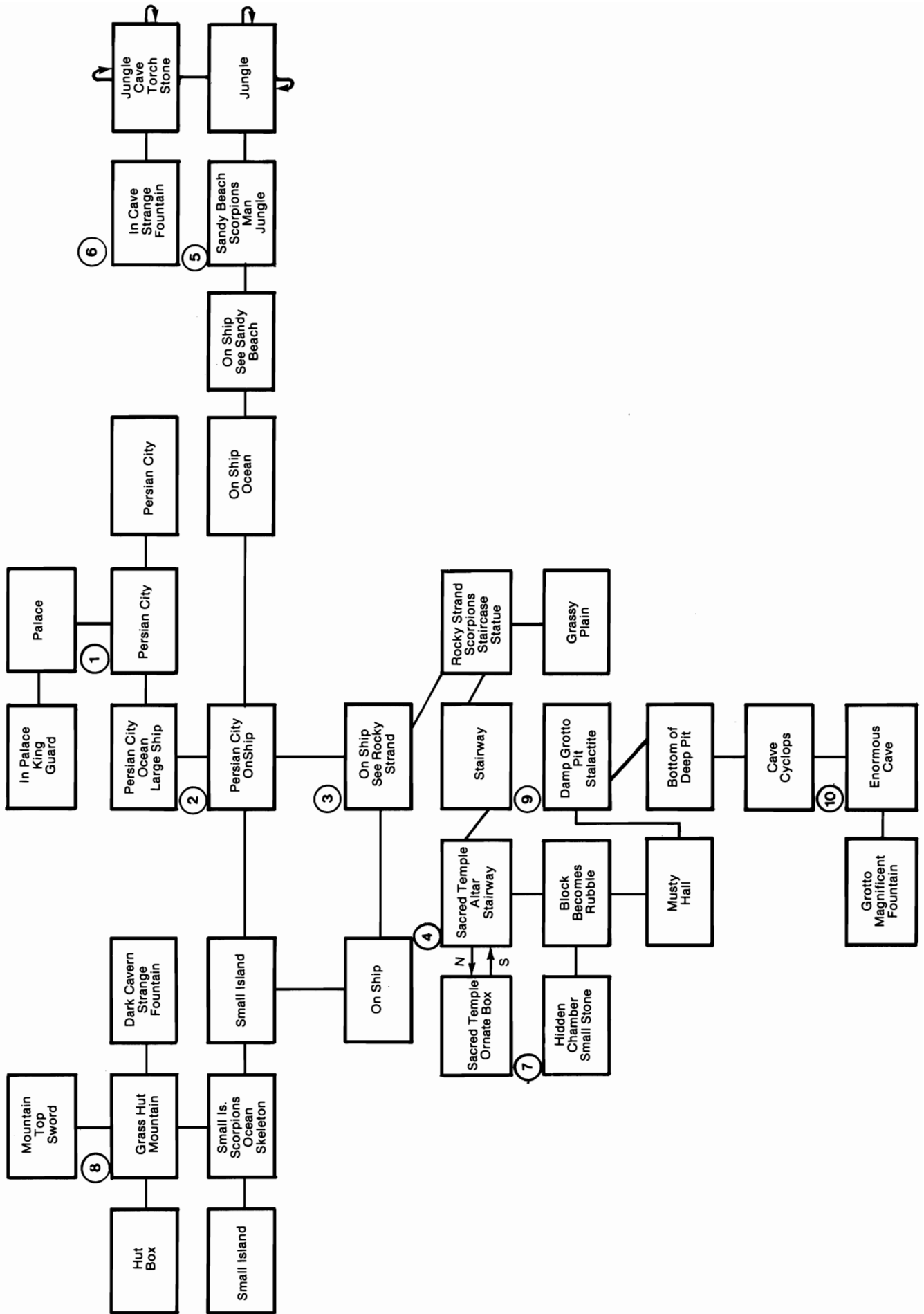

GRUDS IN SPACE

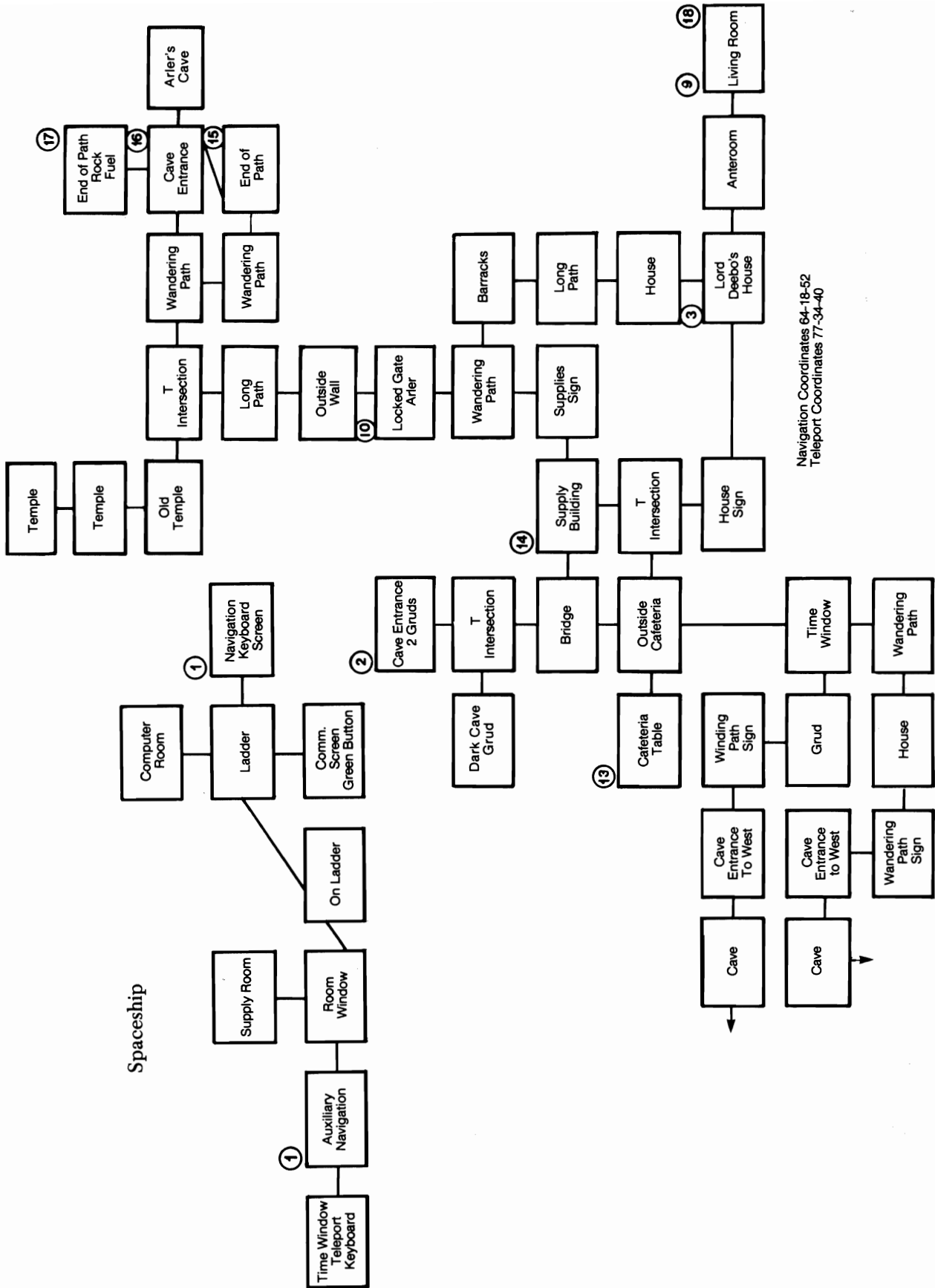

Navigation Coordinates 64-18-52
Teleport Coordinates 77-34-40

GRUDS IN SPACE

Continuation

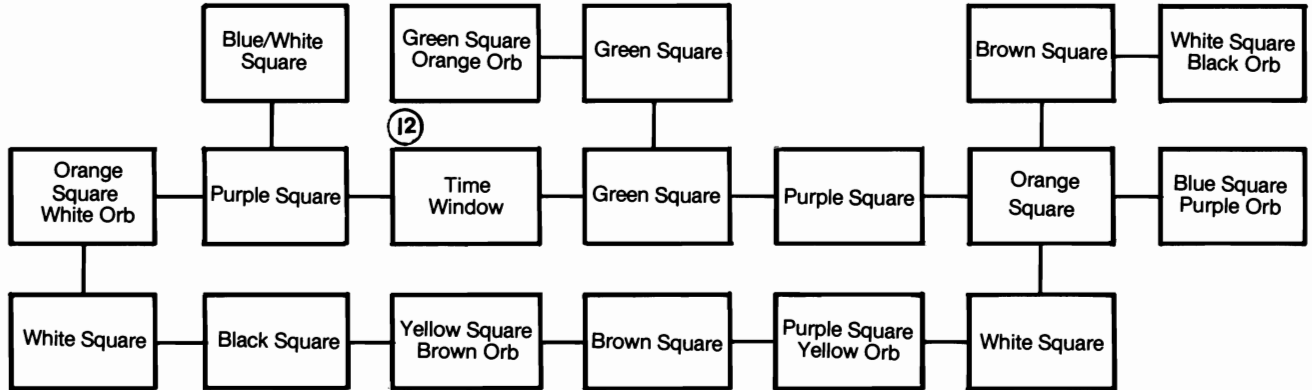

Alien Ship near Venus
 Navigation Coordinates 96-17-14
 Teleport Coordinates 66-12-15

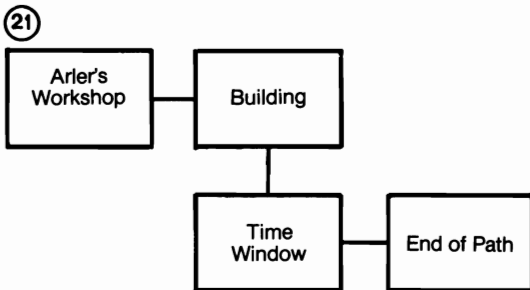

Titan
 Navigation Coordinates 70-10-24
 Teleport Coordinates 14-93-96

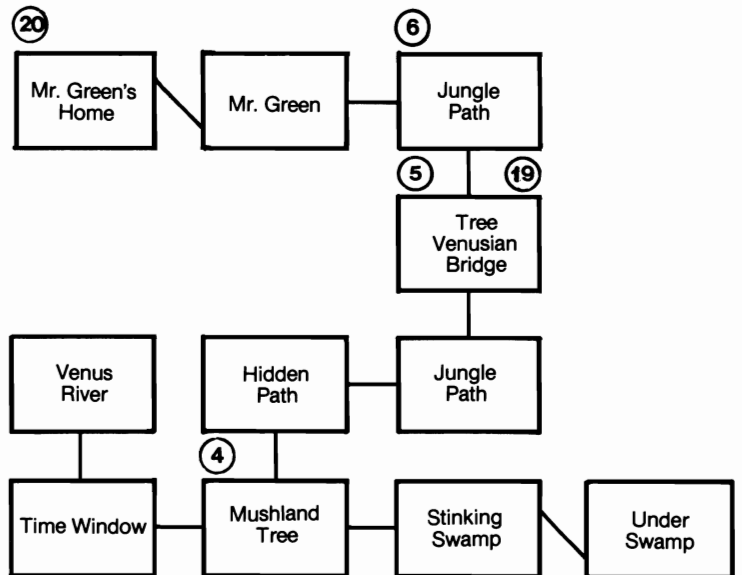

Venus
 Navigation Coordinates 96-17-14
 Teleport Coordinates 82-13-64

GRUDS IN SPACE

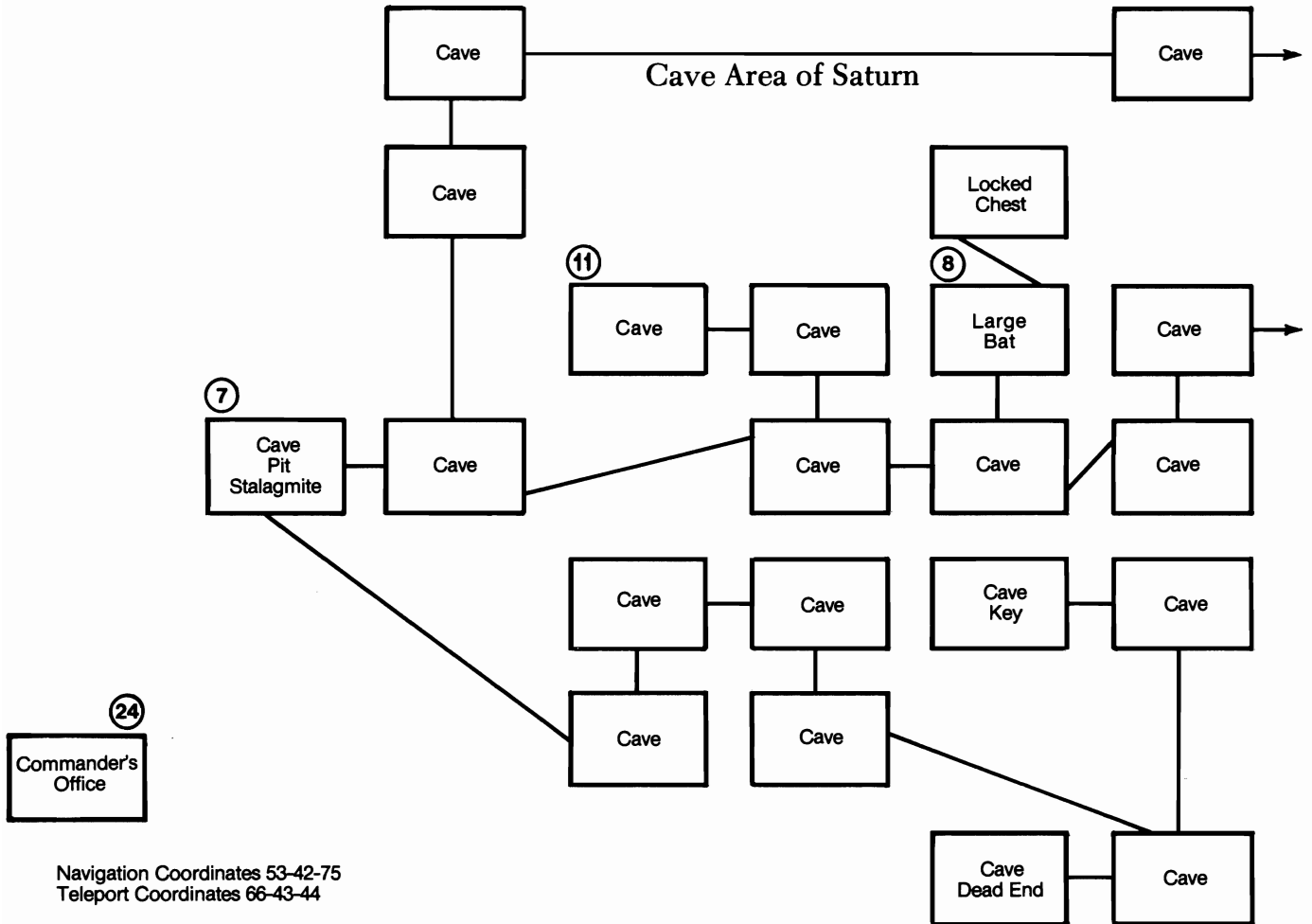

Navigation Coordinates 53-42-75
Teleport Coordinates 66-43-44

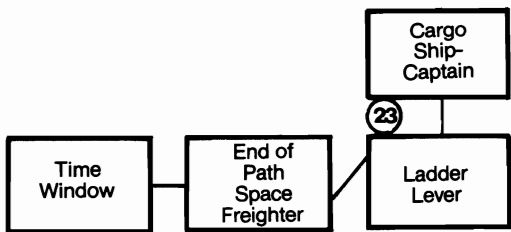

Navigation Coordinates 18-98-32
Teleport Coordinates 34-76-21

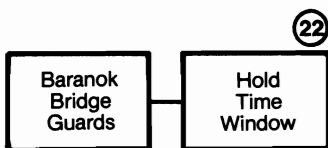

Navigation Coordinates 18-98-32
Teleport Coordinates 36-24-35

INFIDEL

Company: Infocom, Inc.

Suggested Retail: \$49.95

Type: All-text adventure.

Description:

Despite the old theme, you'll find lots of new twists and tough puzzles in this game. You are a not-too-bright archaeologist (in this case, a polite term for grave robber) bent on finding the vast treasures of an Egyptian Queen's pyramid, rumored to lie not far from your camp in the otherwise endless sand. Before it's over, you'd better get a lot smarter if you hope to cope with the devilish traps that the Queen has set for you. Well written, with very interactive puzzles, some given away by the hieroglyphics—if you can read them!

Playability:

Thoroughly enjoyable and fun to play, using the excellent parser, vocabulary and save-game capability now so familiar to Infocom game lovers. You'd better stay alert toward the end of this game if you hope to arrive at the rather unusual ending.

INFIDEL

Part 1

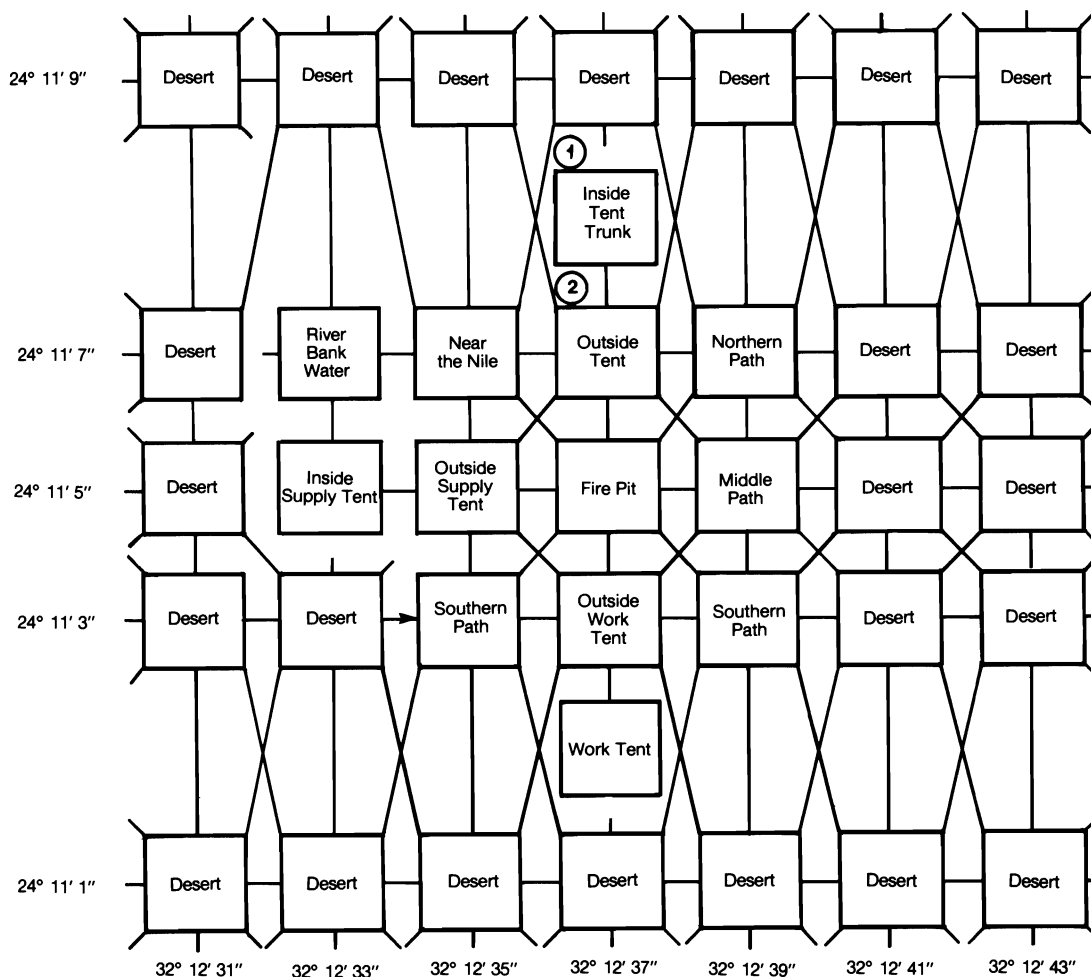

INFIDEL

Part 2

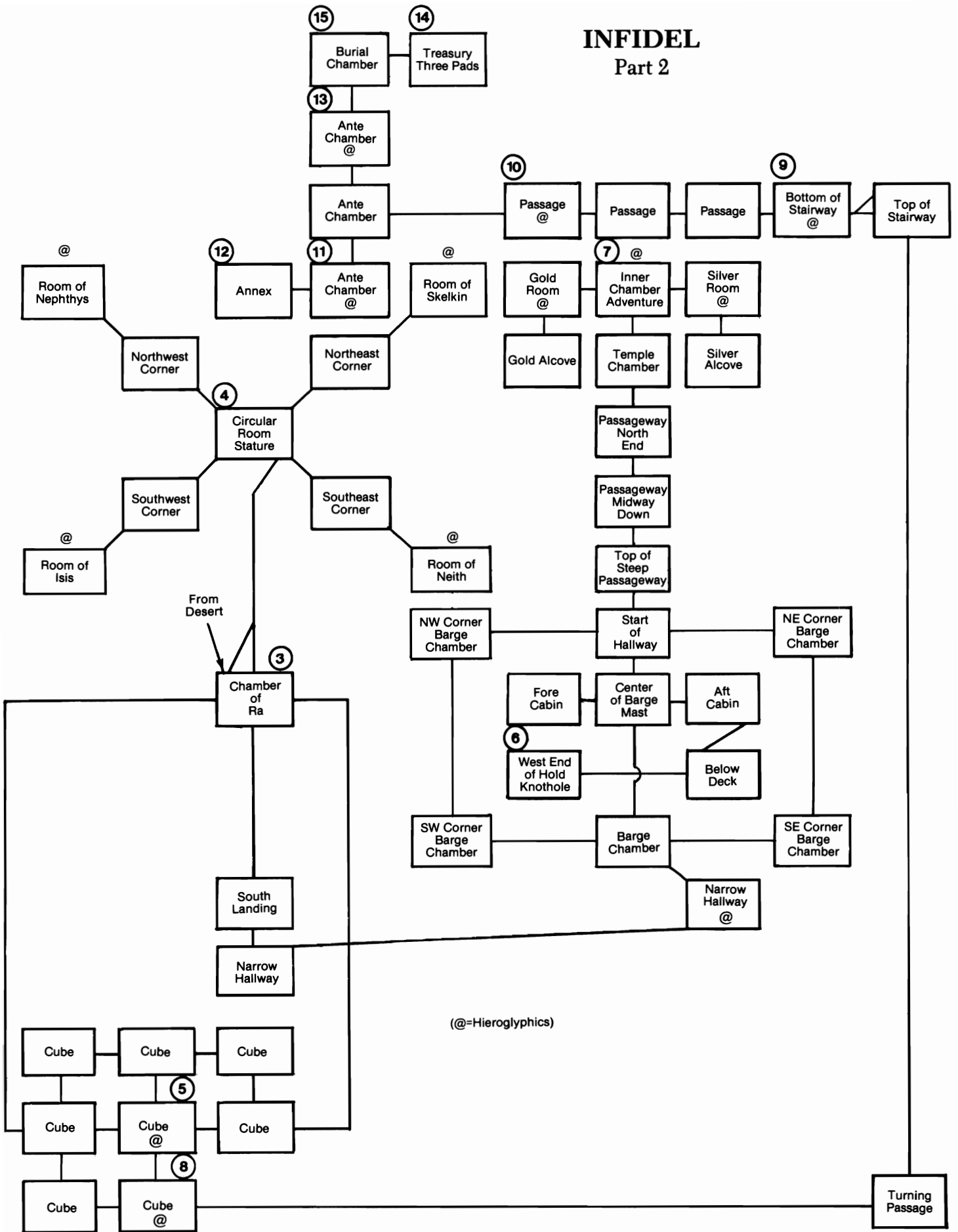

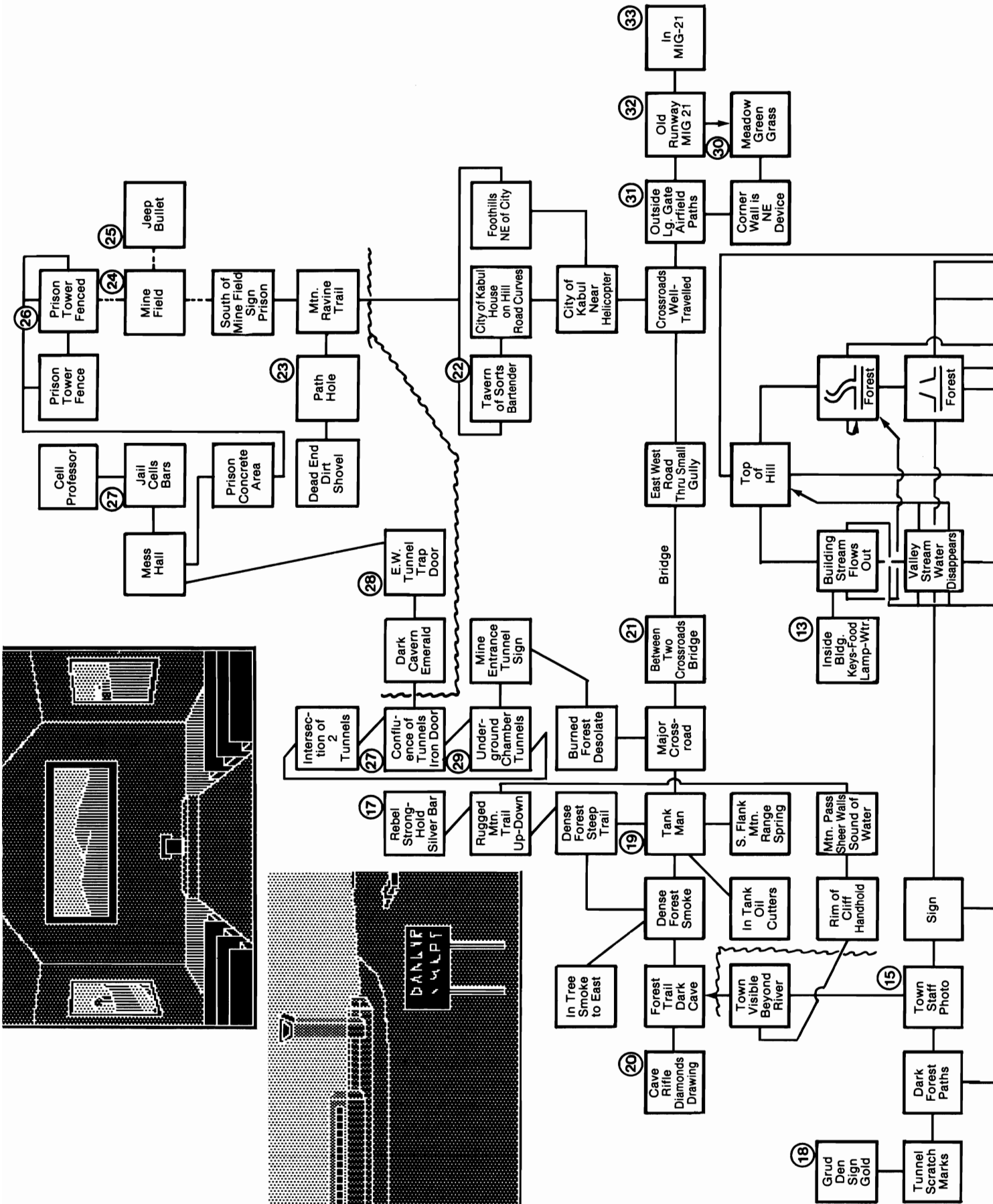
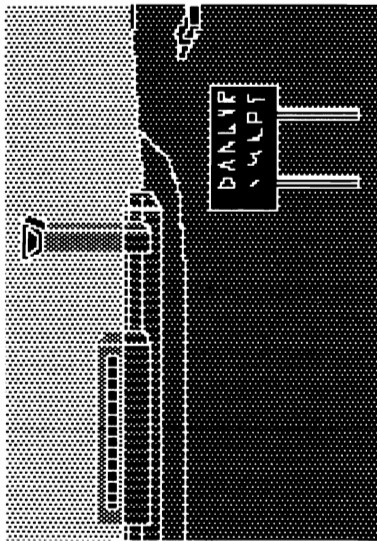
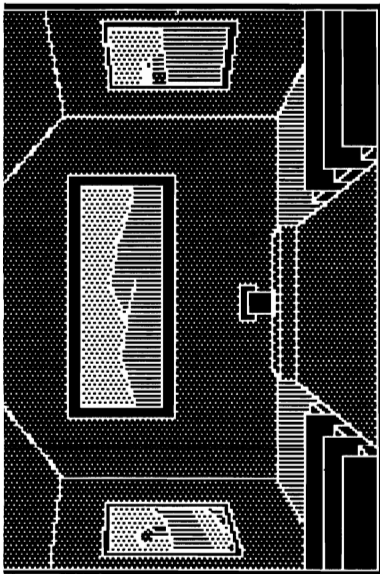

KNIGHT OF DIAMONDS

Company: Sir-Tech Software, Inc.

Suggested Retail: \$34.95

Type: Hi-Res fantasy adventure, a mapmaker's delight.

Description:

The second scenario in the already classic *Wizardry* series. You must find and return the Staff of Gnilda to the City of Llylgamyn. To get started, you need developed characters from the Proving Grounds, whom you transfer to the new scenario. In the dungeon you will meet with the No-See-Ums before too long. Worse than these pests are some of the evil creatures that love to take all but one hit point away from your favorite characters.

Playability:

No specific way of solving *Knight of Diamonds* exists, so don't look in the book for one. Map carefully, grow in strength, get to the sixth level. When you're there, remember The Knight of Diamonds and Shield. Don't tackle this one unless you are a *Wizardry* expert and have at least Level 13 characters. *Knight of Diamonds* is the maze-type adventure at its best. You can play with one to six people (with one person acting as the Dungeon Master at the keyboard). It will provide many interesting hours of game fantasy, albeit somewhat repetitive.

KNIGHT OF DIAMONDS

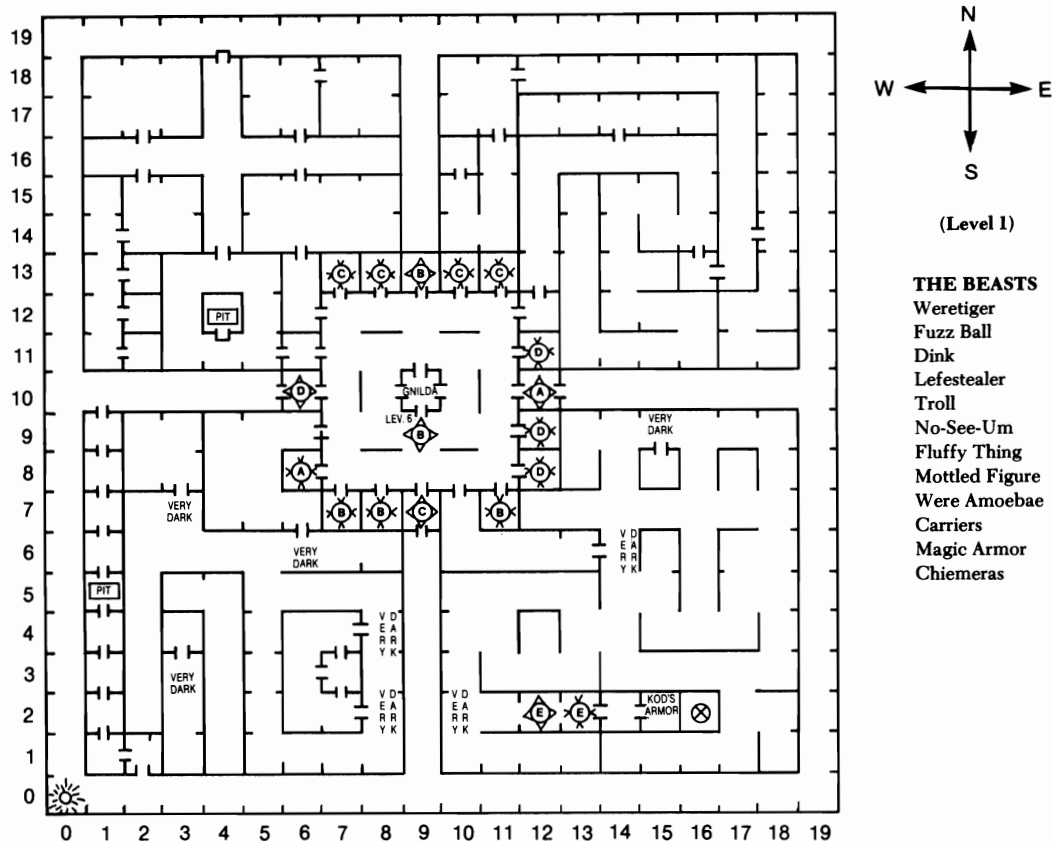

KNIGHT OF DIAMONDS

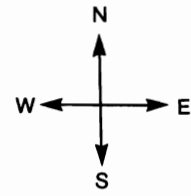
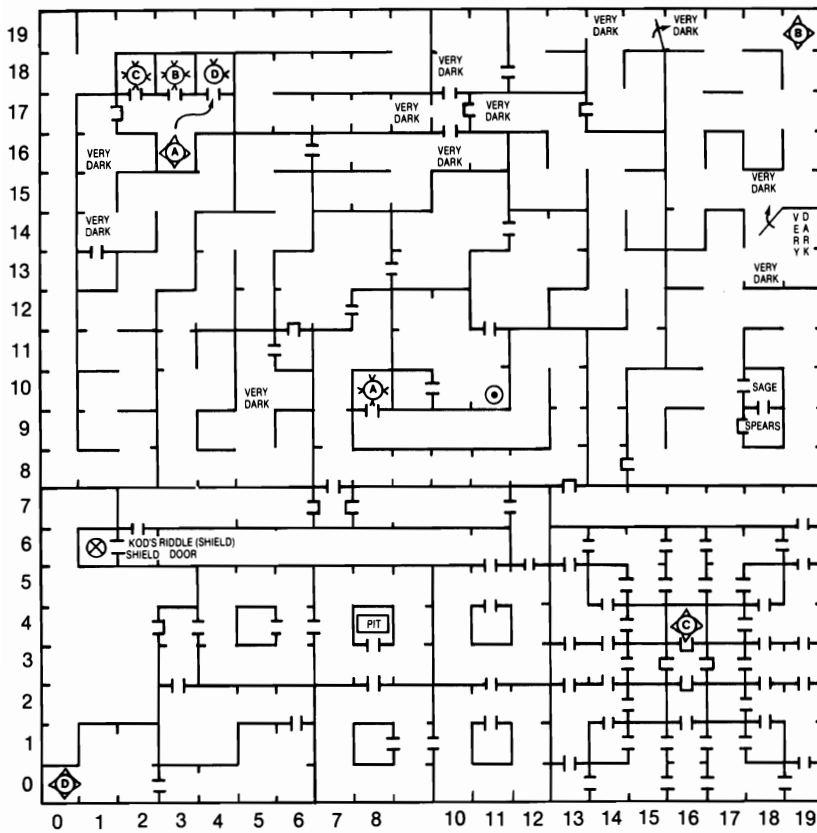

(Level 2)

THE BEASTS

- Rhind Beetle
- Scorpion
- Nightstalker
- Evil Eyes
- Ogres
- Ogre Lords
- Gaunt Figure
- Magic Shield
- Gorgons
- Wyverns
- Lesser Demons
- Flame Rod
- Jeweled Amulet
- Amulet of Skill
- Dreamers Stone

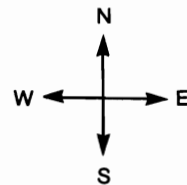
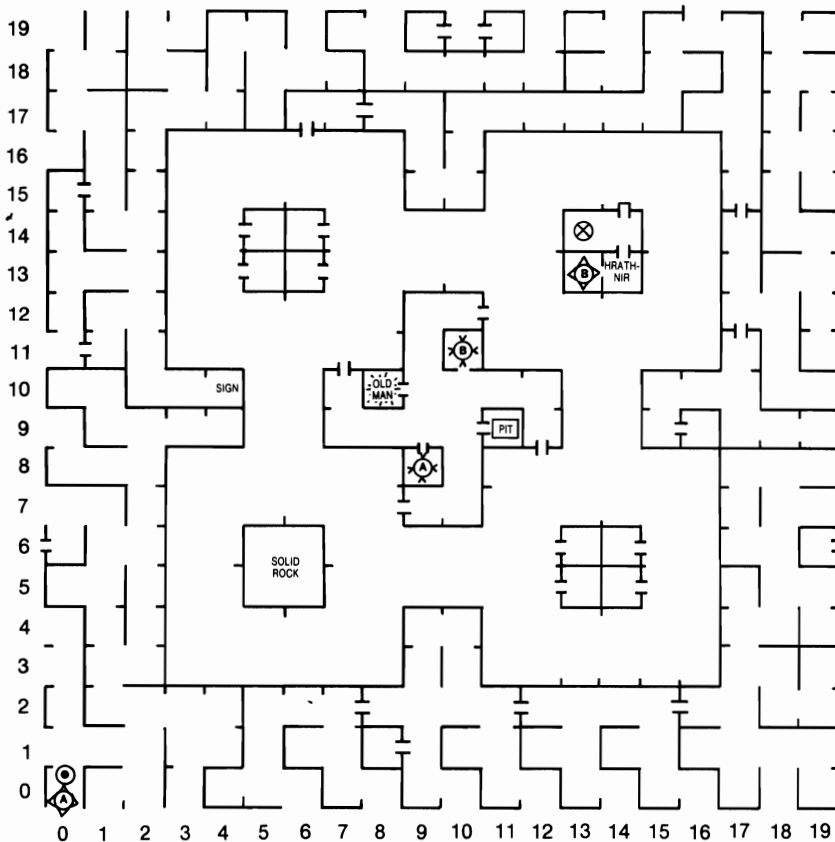

(Level 3)

THE BEASTS

- Giant Vipers
- Murphy's Ghost
- Bleepers

OBJECTS:

- Broad Sword—Hrathnir

KNIGHT OF DIAMONDS

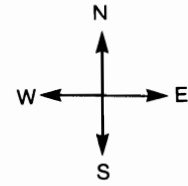
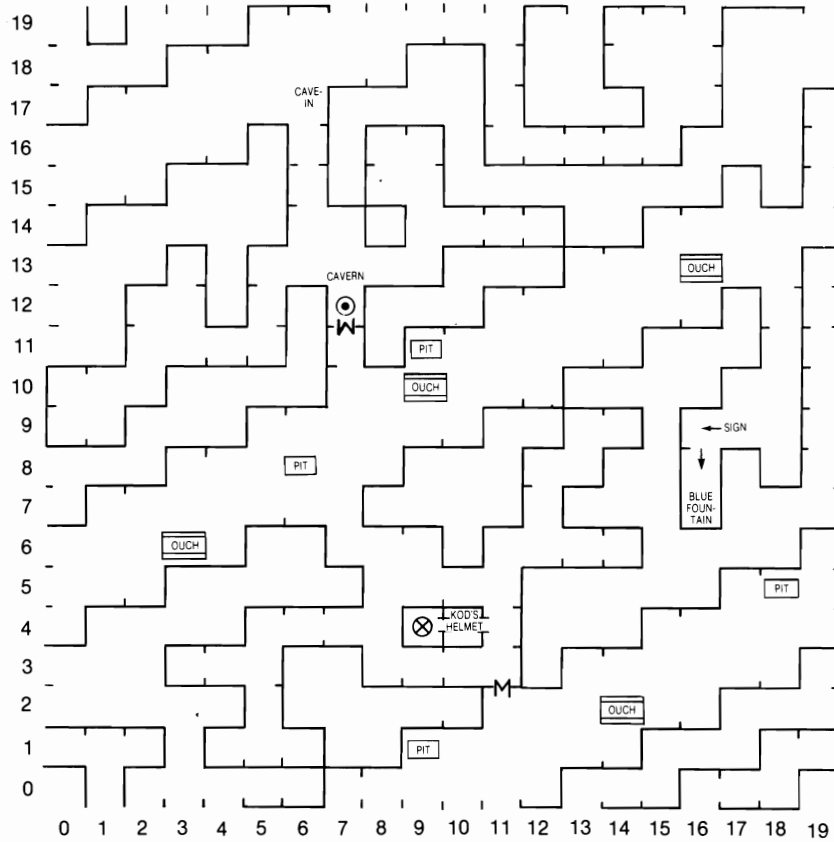

(Level 4)

THE BEASTS

- Acid Slimes
- Will O'Wisps
- Giant Zombies
- Were Bats
- Giant Bats
- Foaming Molds
- Succubi
- Constrictors
- Magic Helmet (Kod's)

OBJECTS:

- Amulet of Skill
- Mace Pro Poison
- Amulet/Makanito

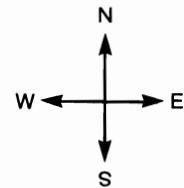
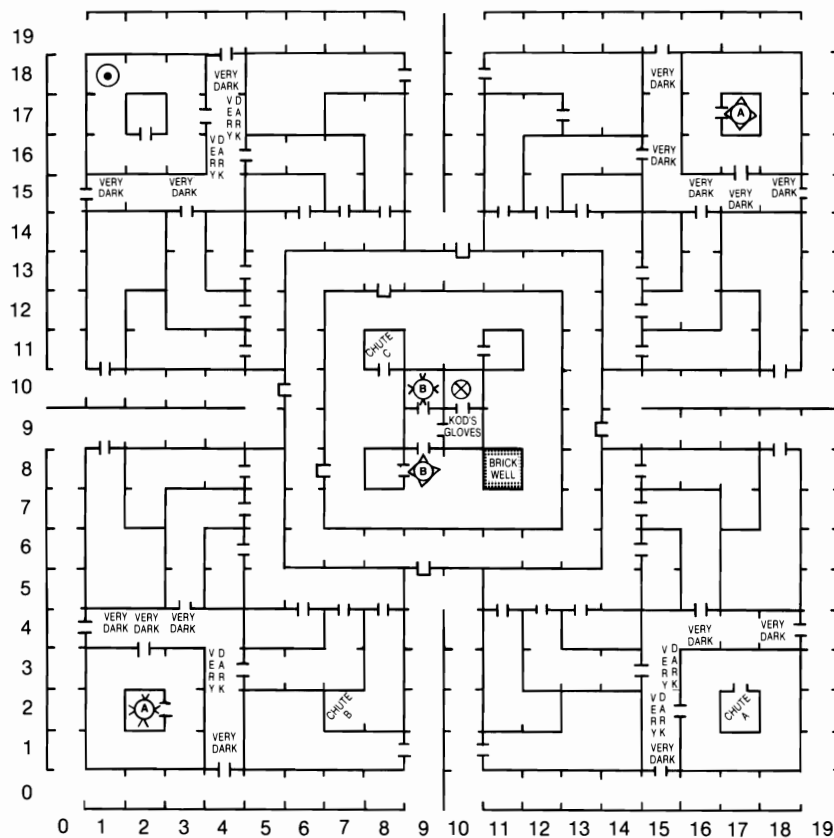

(Level 5)

THE BEASTS

- Wasp Swarm
- Scrylls
- Evil Eyes
- Giant Zombie
- Succubi
- Fire Dragons
- Fire Giants

KNIGHT OF DIAMONDS

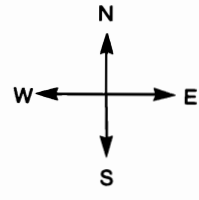
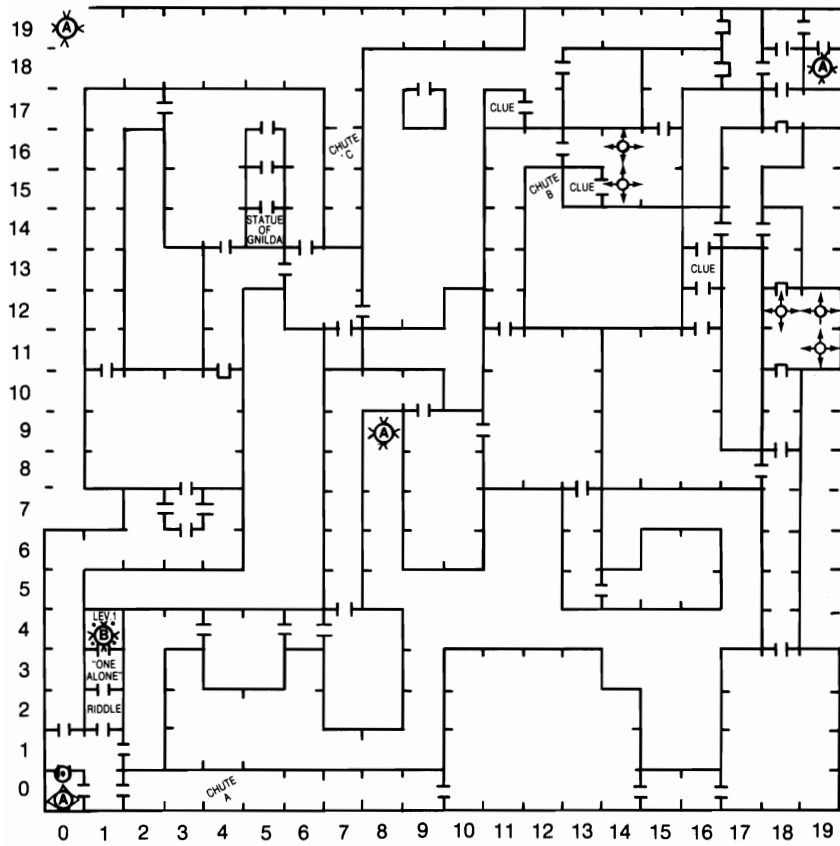

(Level 6)

THE BEASTS

- Blobs
- Flack
- High Wizards
- Air Giants
- Hatamoto

OBJECTS:

- Staff of Light
- Mind Stone
- Damien Stone

SYMBOLS

- STAIRS DOWN
- STAIRS UP
- ONE WAY DOOR
- ONE WAY PASSAGE
- N.D. NO DOOR
- SPINNER
- TELEPORT FROM LEV 5
- TELEPORT TO LEV 3
- PIT**
- OUCH**
- LOOKING EAST APPEARS ENDLESS (N.D.)
- CLOSING PANEL

NOTE

INVISIBLE DOORS
SHOWN NORMAL

LABYRINTH OF CRETE

Company: Adventure International

Suggested Retail: \$29.95

Type: All-text adventure.

Description:

Two independently controlled characters, Jason and Hercules, represent your alter ego. Your mission: to recover the Golden Fleece. Doing so, you earn the respect of the inhabitants of Mount Olympus, who grant you access to that exclusive area. You'll explore three different worlds, solve a plethora of puzzles, and encounter most of the gods, goddesses, and creatures of Greek mythology. You don't have to know anything about mythology, nor will you learn anything about it from the game.

Playability:

The concept of interacting characters who can combine their talents to solve a given puzzle is an innovation in adventure games. Unfortunately, this game's implementation falls short of its conceptual promise. You can solve the majority of puzzles simply by Giving or Dropping the right object at the right location; you can only use most objects in the world in which you find them. The game is long and not too difficult, but reasonably fun to play and has more puzzles than you can shake a stick at.

LABYRINTH OF CRETE

Part 2

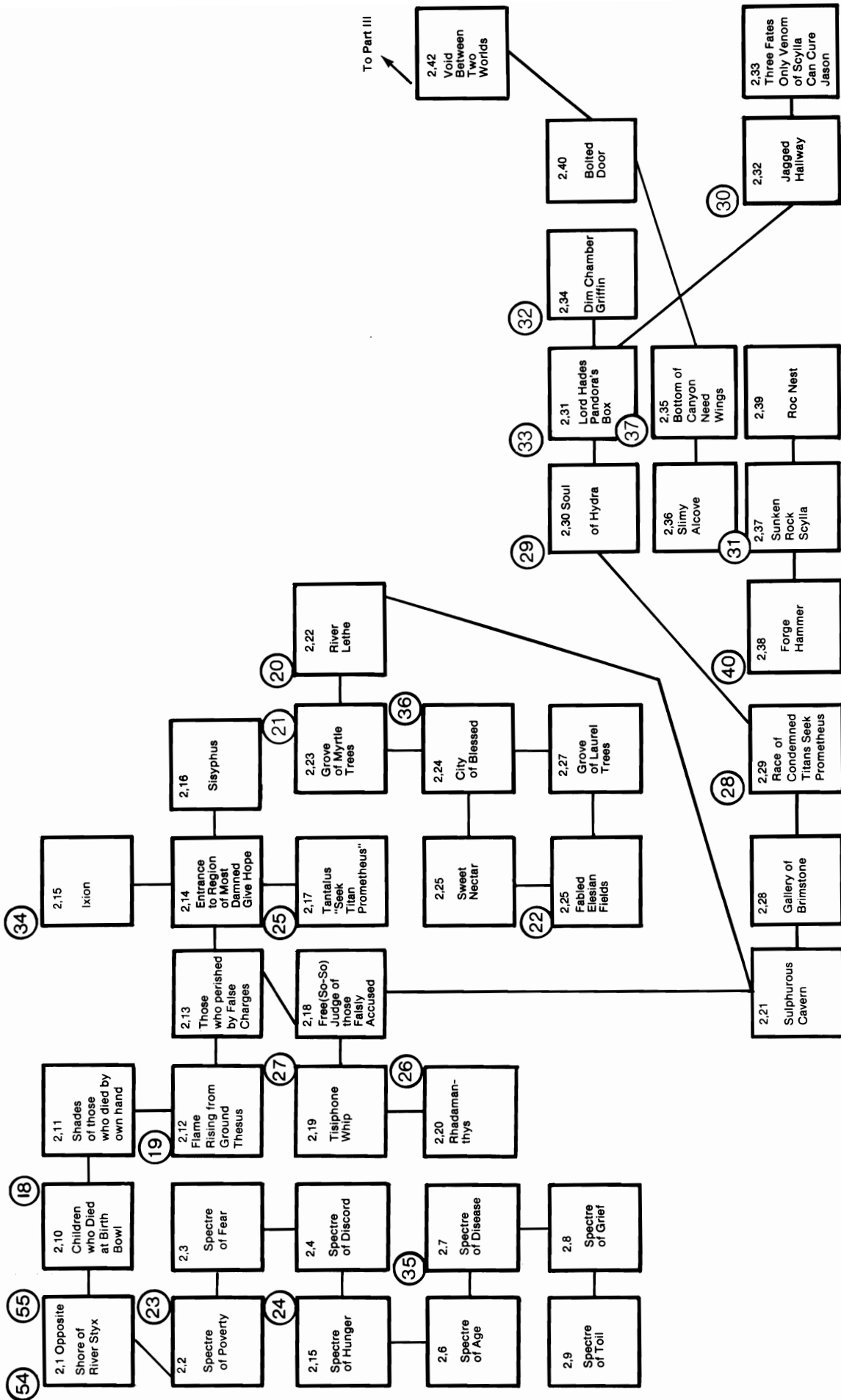

LEGACY OF LLYLGAMYN

Company: Sir-Tech Software, Inc.

Suggested Retail: \$39.95

Type: A Hi-Res fantasy.

Description:

Third in the *Wizardry* series, and another map-maker's delight with six additional levels. Evil times have again befallen the kingdom and famed warriors, such as yourself, are called on to find the mystical orb hidden deep within a dragon's mountain lair. The orb possesses the power to reveal the source of danger, and therein lies the hope of the world. The graphics look better than ever, and those of the introduction are nifty indeed. A few more puzzles appear in *Llylgamyn* than did before, mostly in the form of not-too-difficult riddles.

Playability:

You need the basic *Wizardry* disk in order to create characters, who must then undergo the Rite of Passage Ceremony. Then you can enjoy the fine graphics. If you've played prior games with a single alignment, you'll need to change your thinking as both "good" and "evil" parties of characters are required for success. There's still no way to save the game in the bowels of the dungeon.

LEGACY OF LLYLGAMYN

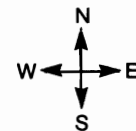
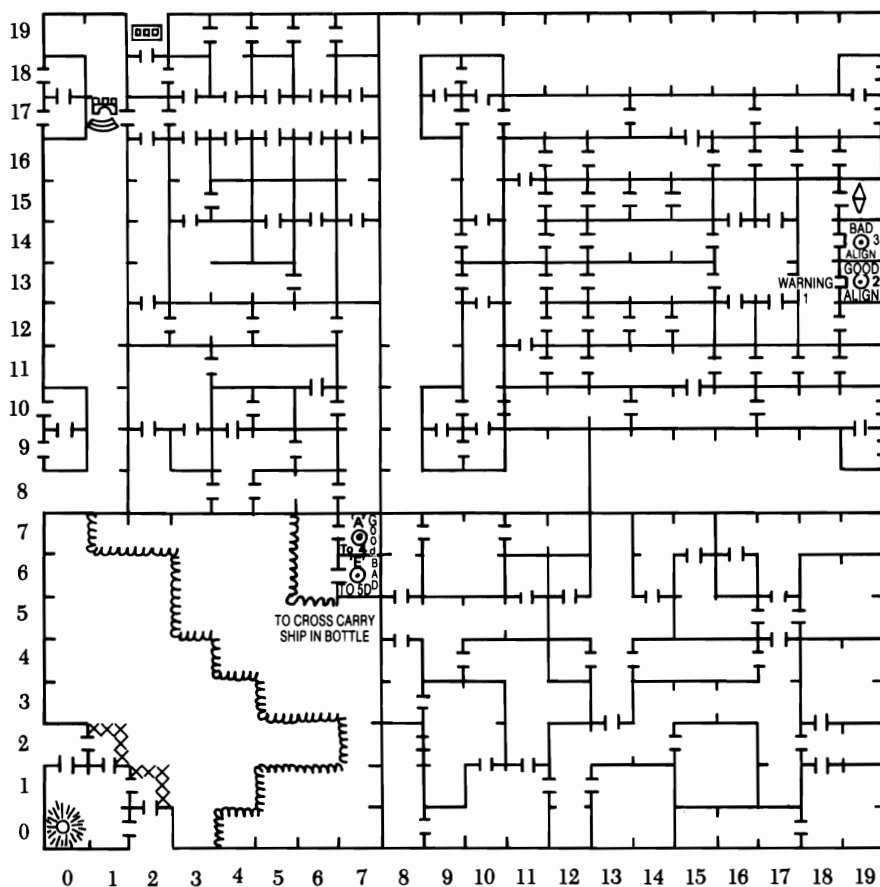

(Level 1)

- THE BEASTS:**
- High Corsair
 - Garian Raiders
 - Giant Serpents
 - Slimy Thing
 - Garin Priests
 - Anacondas
 - Garian Captains
 - Giant Slug
 - Strange Plants
 - Crawling Kelp
 - Dusters
 - Shadowy Figures
 - Garian Mages
 - Moat Monsters
 - Large Snakes
 - Unseen Entities
 - Poltergeists
 - Garian Guards
 - Corsairs

LEGACY OF LLYLGAMYN

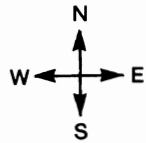
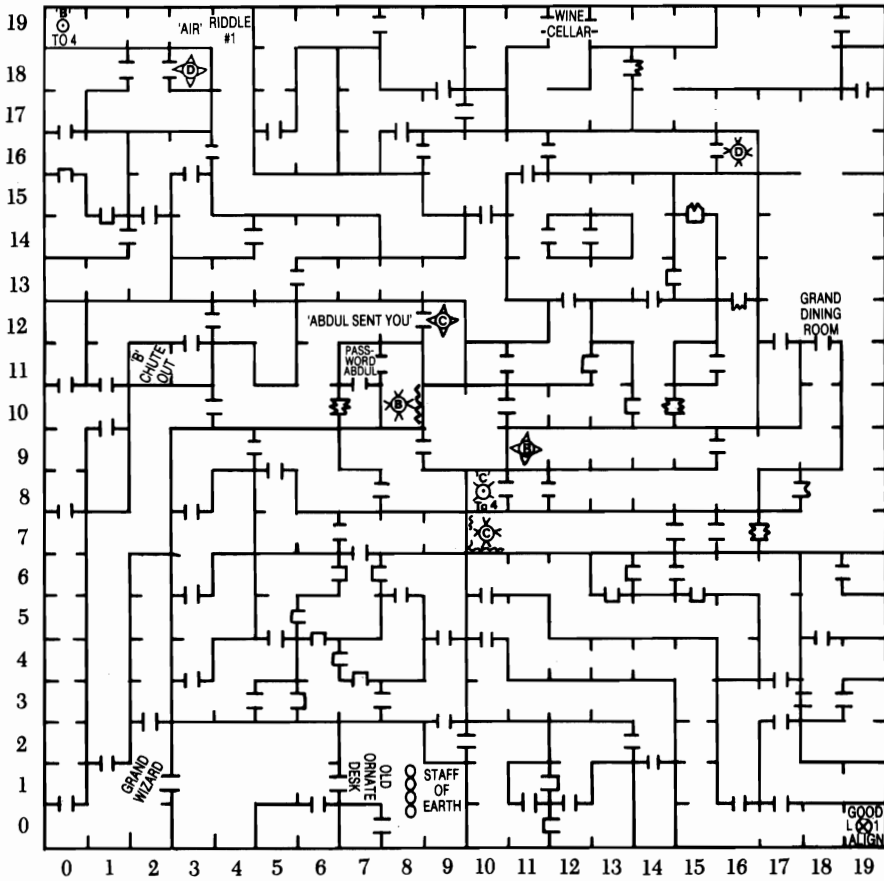

(Level 2) GOOD ALIGNMENT

THE BEASTS:

- Komodo Dragons
- Looters
- Pole
- Friars
- Dark Steed
- Were Vulture
- Men in Black
- Harpies
- Strangler Vines
- Men in Leather
- Goblins
- Hobgoblins
- Strange Animal
- Banshees
- Ashers
- Ninja
- Witch
- Women in Robes
- Men in Arms
- Vultures
- Strange Birds
- Shadowy Figures
- Mummies
- Gaunt Figures
- Ronin
- Men in Armor

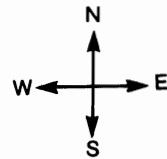
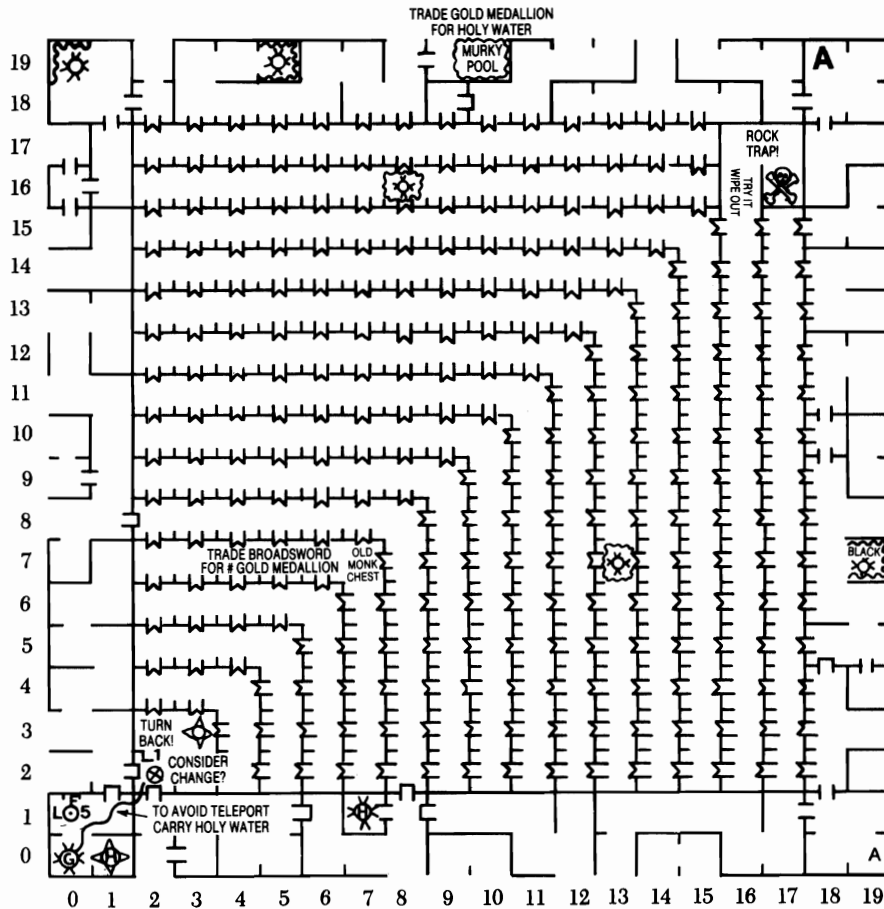

(Level 3) EVIL ALIGNMENT

THE BEASTS

- Ronin
- Dusters
- Ashers
- Bengal Tigers
- Mummies
- Leprechaun
- Were Vultures
- Witches
- Pixies
- Men at Arms

LEGACY OF LLYLGAMYN

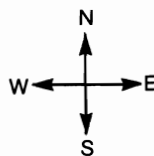
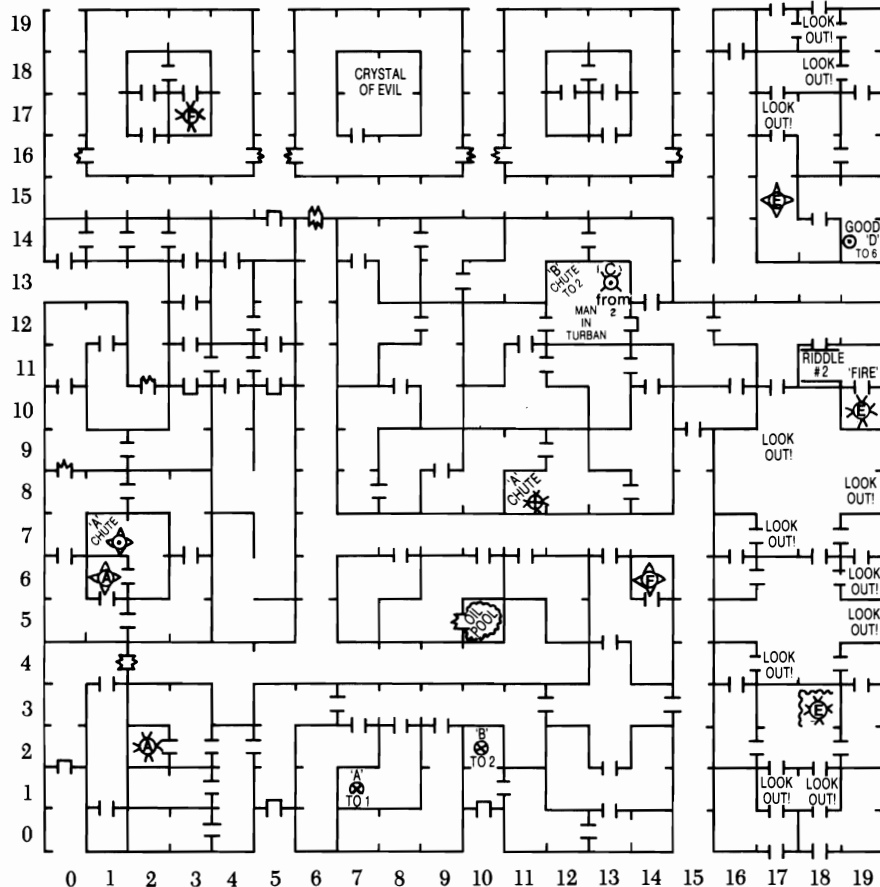

(Level 4) GOOD ALIGNMENT

THE BEASTS

- Wights
- Ronin
- Necromancers
- Delf's Minions
- Delf
- Friars
- Master Ninja
- 2-Headed Snakes
- Romodo Dragons
- Dark Steed
- Dark Rider
- Banshees
- Men at Arms
- Giant Ants
- Goblin Princes
- Dwarf Fighters
- Strangler Vines
- Goblins
- Hobgoblins
- Goblin Shamans
- Cockatrice
- Acolytes

- Were Tiger
- Bengal Tigers
- Strange Animals
- Burglars
- Giant Leech
- Slimy Thing

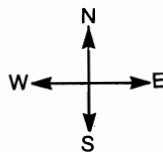
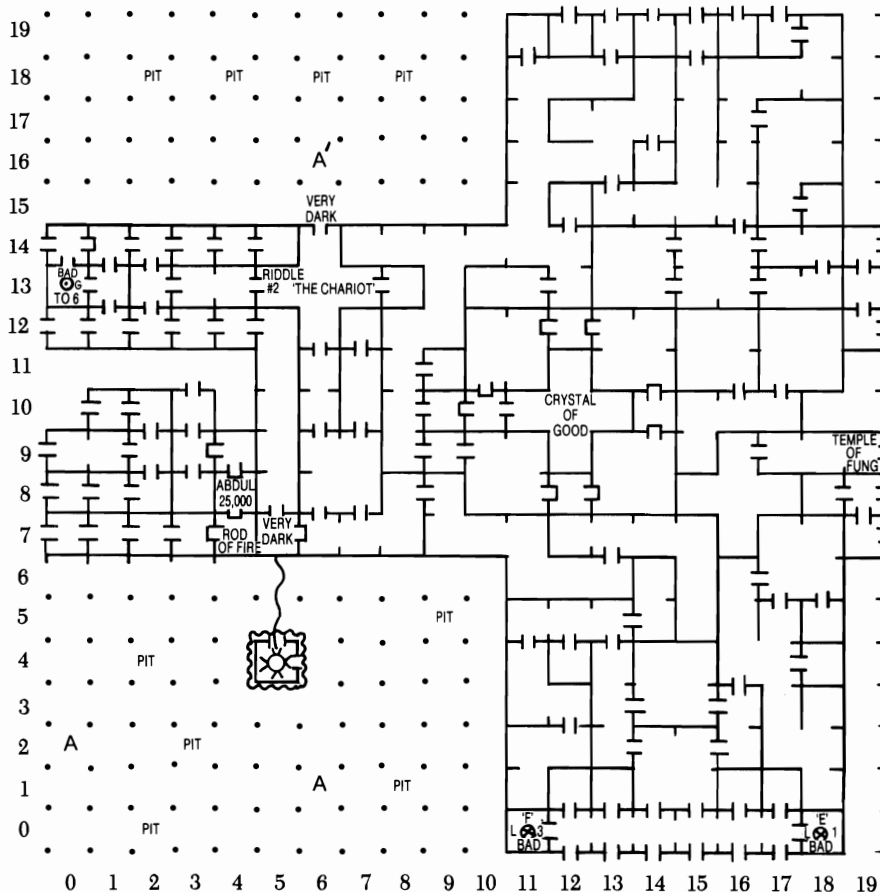

(Level 5) EVIL ALIGNMENT

THE BEASTS

- Unicorn
- Giant Leech
- Samuria
- Bengal Tigers
- Were Tigers
- Tien Lung
- Priests of Fung
- Komodo Dragons
- Fairies
- Wights
- Angels
- Vultures
- Giant Ants
- Strangler Vines
- Roc
- Unicorn
- Seraph
- Crusaders
- Crusader Lords
- Dwarf Fighters
- Acolytes

LEGACY OF LLYLGAMYN

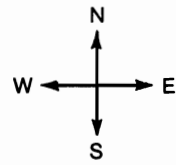
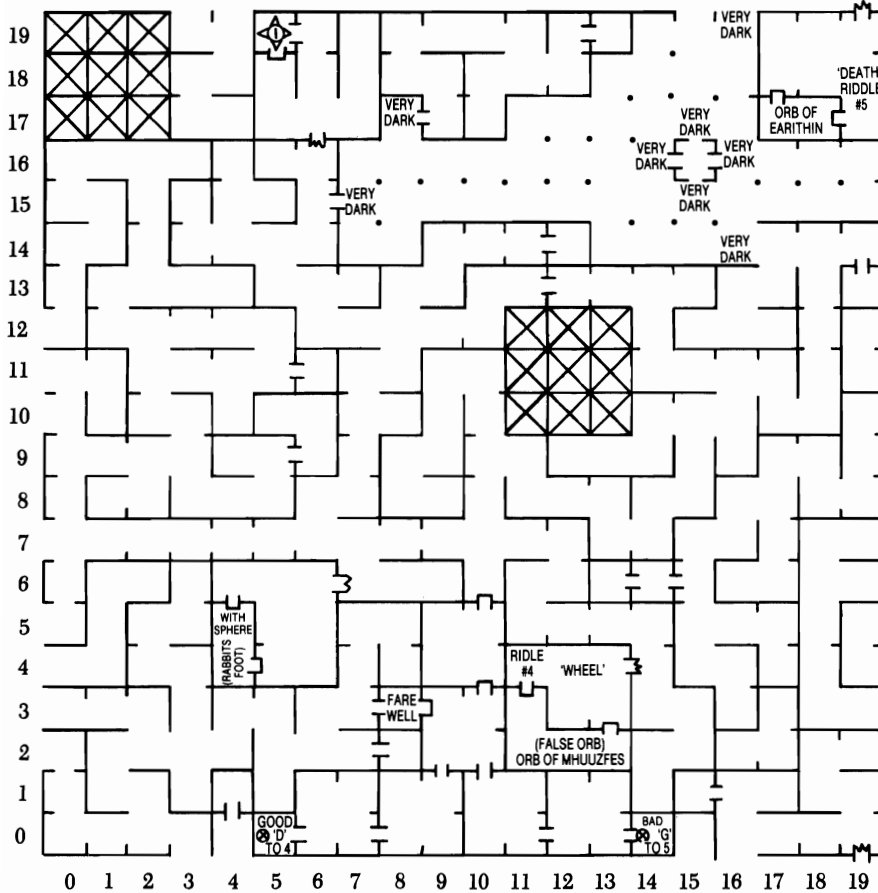

(Level 6)

THE BEASTS

- Unicorn
- Seraph
- Archangel
- Burglars
- Wights
- Ghasts
- Nifune
- Gnone Priests
- Anacondas
- 2-Headed Snakes
- Hydra
- Giant Gorillas
- Doppelgangers
- L'Kbreth
- Men at Arms
- Dwarf Fighters
- Berserkers
- Elven Mages
- Xeno

SYMBOLS

- | | | | |
|-----|--|---|--|
| XXX | BEACH | A | ABDUL'S ETHEREAL TAXI SERVICE - 2500 GP ONEWAY (Level 3) |
| ~ | WATER'S EDGE | A | ABDUL'S ETHEREAL TAXI SERVICE—5000 G.P. (Level 5) |
| [] | BARRACKS | | |
| [] | FORTRESS/MOAT | | |
| [] | TELEPORT TO CASTLE | | |
| ○ | STAIRS UP | | |
| ⊗ | STAIRS DOWN | | |
| [] | — ONE WAY DOOR | | |
| ○ | ONE WAY STAIR | | |
| ◇ | TELEPORT (OUT) | | |
| ⊙ | TELEPORT (IN) | | |
| [] | INVISIBLE ONE WAY WALL | | |
| [] | ONE WAY STAIR—CAN'T RETURN | | |
| ◇ | TELEPORT TO LEVEL 1
0 NORTH, 0 EAST STAIRS
TO CASTLE | | |
| ⊗ | ROCK | | |
| ~ | ILLUSION | | |

MADVENTURE

Company: Micro Lab

Suggested Retail: \$34.95

Type: All-text adventure.

Description:

First, get fifteen treasures to the theater lobby and visit those locations that contribute points to the maximum of 400. Next, accomplish the above in less than 185 moves. This game contains the author's choice of the best single puzzle in all adventuredom.

Playability:

Not recommended for beginning or intermediate puzzle-game players. Perhaps the most challenging set of puzzles yet combined into one program, it is some three times the size of typical Scott Adams puzzlers. The system will load a saved-game from a scratch disk. This is a super-tough, crisp game for the puzzle nut!



MADVENTURE Maze

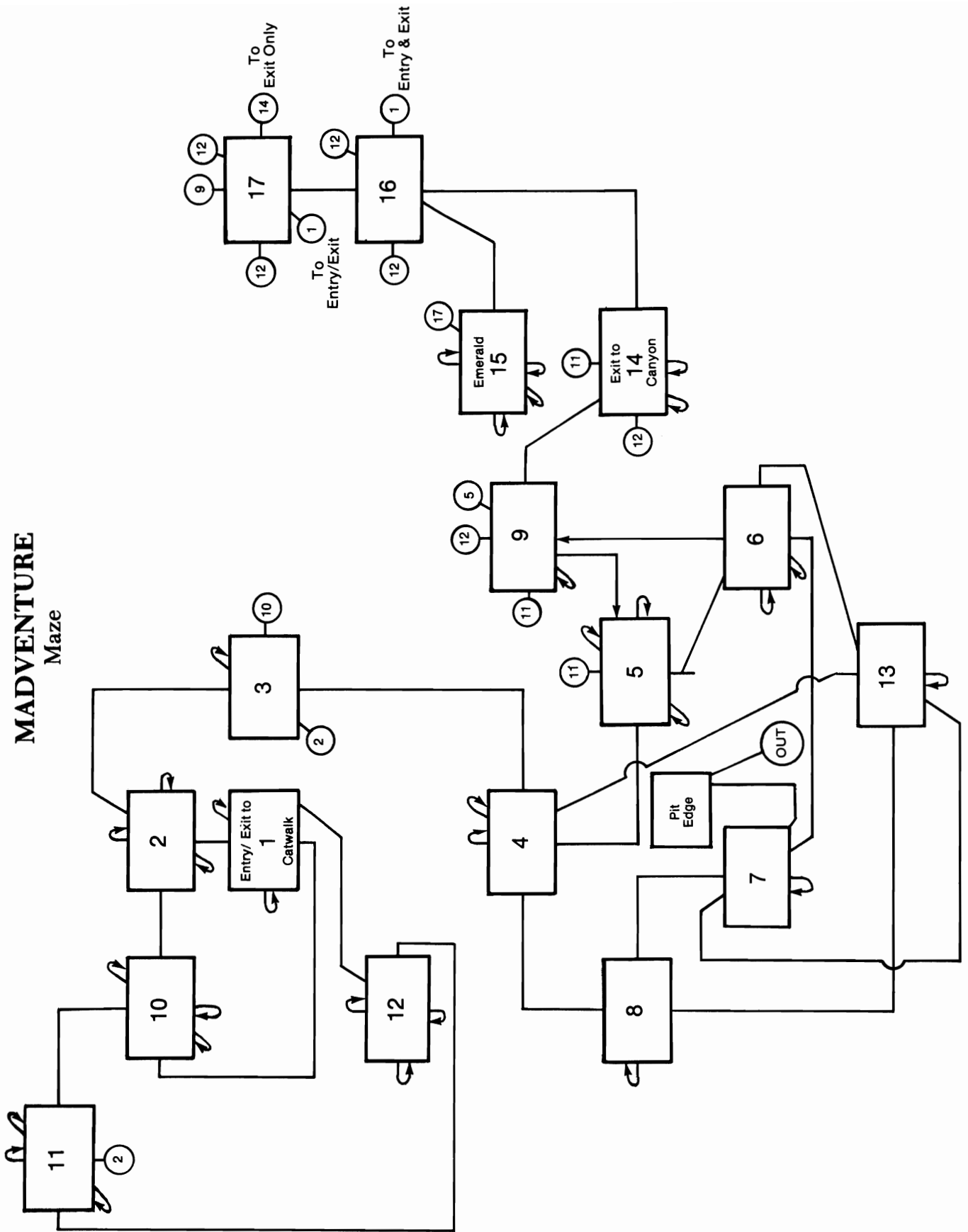

MASK OF THE SUN

Company: Ultrasoft

Suggested Retail: \$39.95

Type: An animated Hi-Res adventure with color graphics and Hi-Res text.

Description:

You as Mac Steele must find the legendary Mask to cure your mysterious malady, held in check only by the pills which you must always carry. You spend much time on the road in a bouncing jeep, and even more time in a bouncing sort of walk through drab tunnels. You must hurdle a Real-time, semi-arcade like lava pit and correctly answer any one out of three riddles in order to get through two locations.

Playability:

The *Mask of the Sun* offers several challenges not found too often in adventures. By far the most difficult task is unraveling the mystery of the maze, actually two mazes separated by a room ready to fall in on your ears. An average adventure, with a higher than average degree of difficulty.

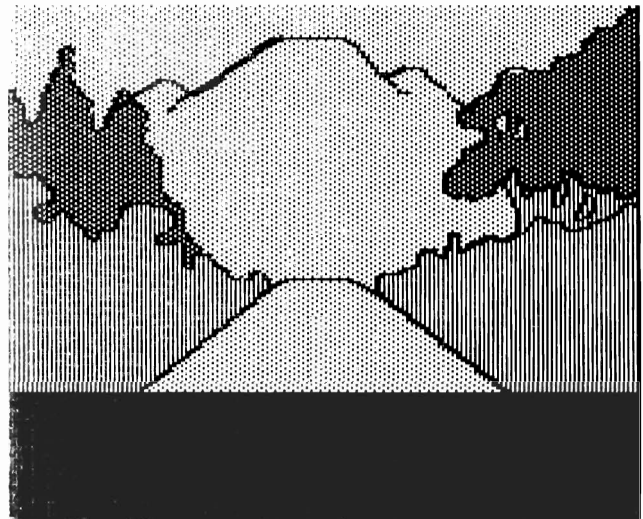

MASK OF THE SUN

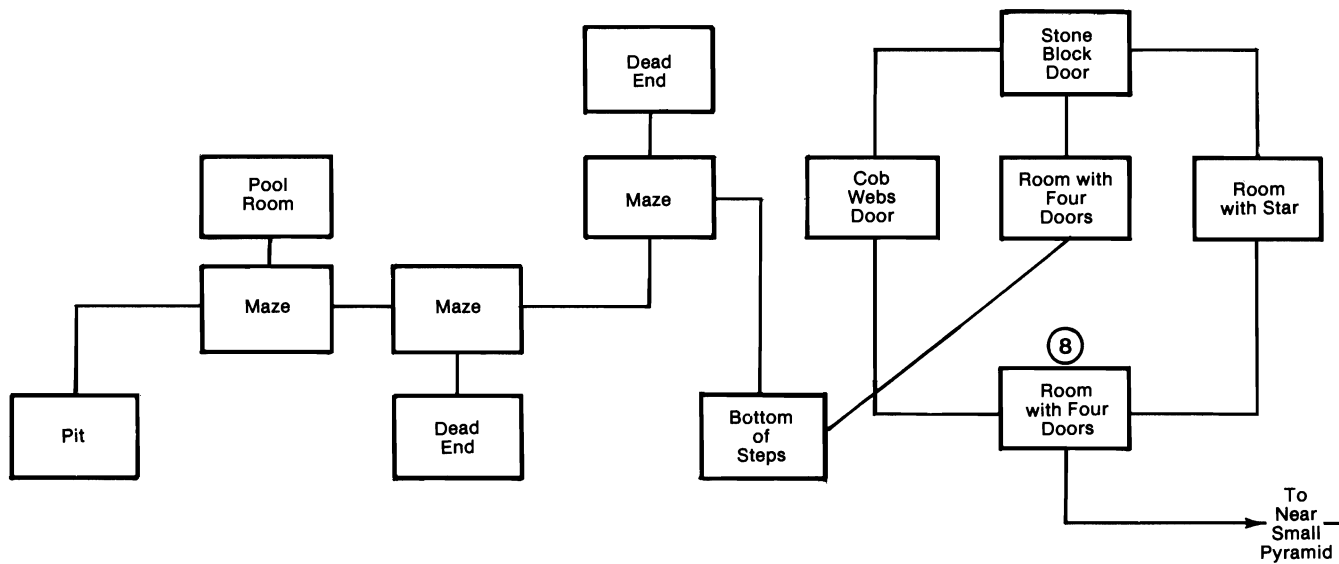

MASK OF THE SUN

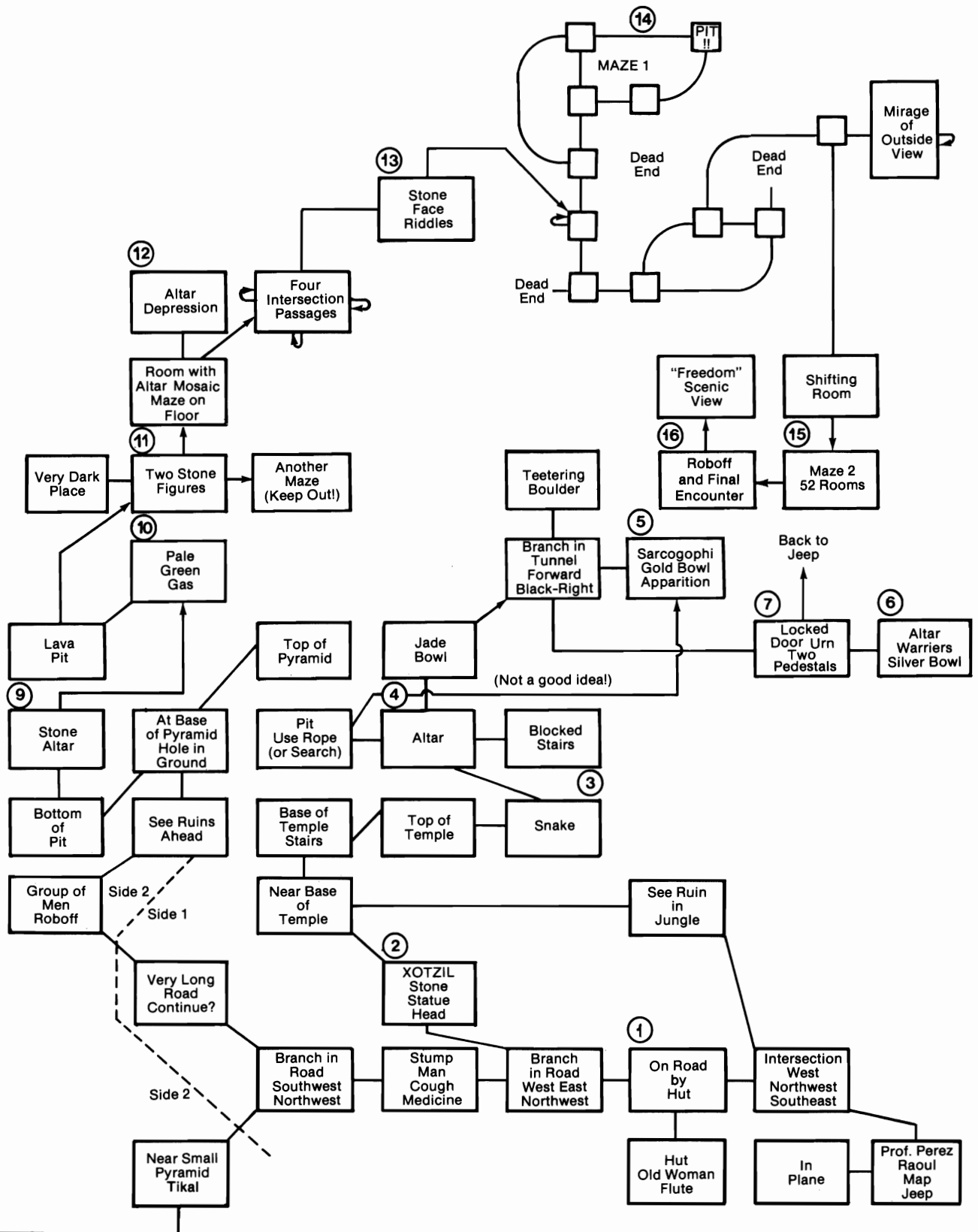

MISSION: ASTEROID

Company: Sierra On-Line Systems

Suggested Retail: \$19.95

Type: A Hi-Res adventure with color graphics.

Description:

Your mission: to destroy an approaching asteroid before it collides with the planet Earth. Yes, there's a time limit.

Playability:

The elements of the puzzles prove easy to solve individually. In fact, this game is very easy right up to (almost) the very end. However, you have a fixed number of moves and a time limit of five minutes per move. Saving a game requires you to use a move. *Mission. Asteroid* is a winner: totally straightforward and solvable while presenting the challenge of completing it within the tough time constraint.

MISSION: ASTEROID

Continuation

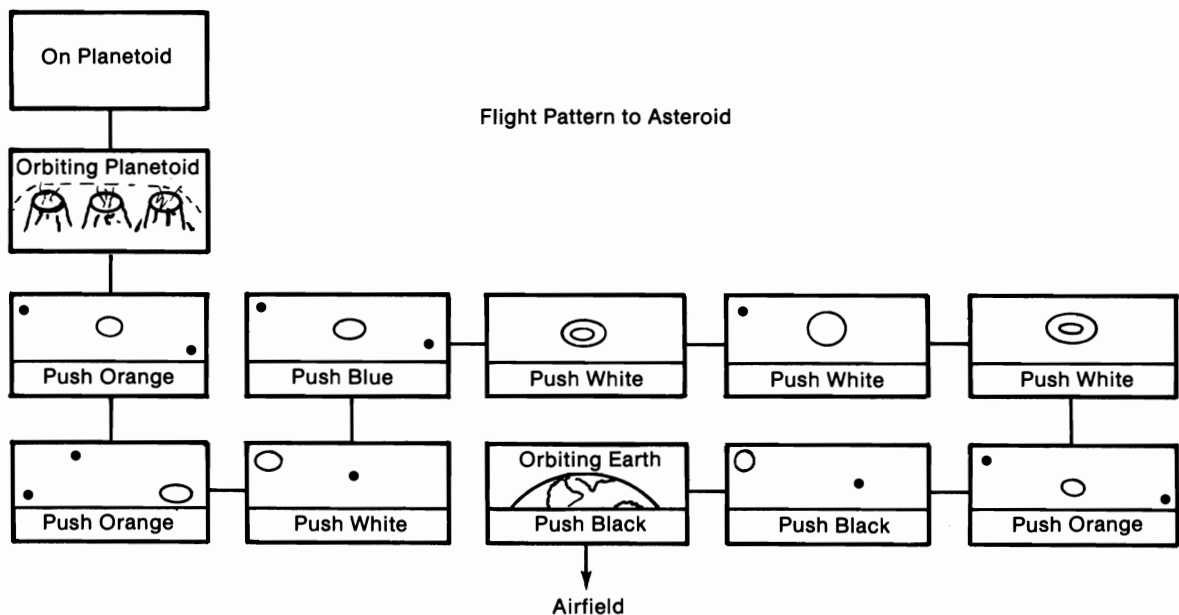

MISSION: ASTEROID

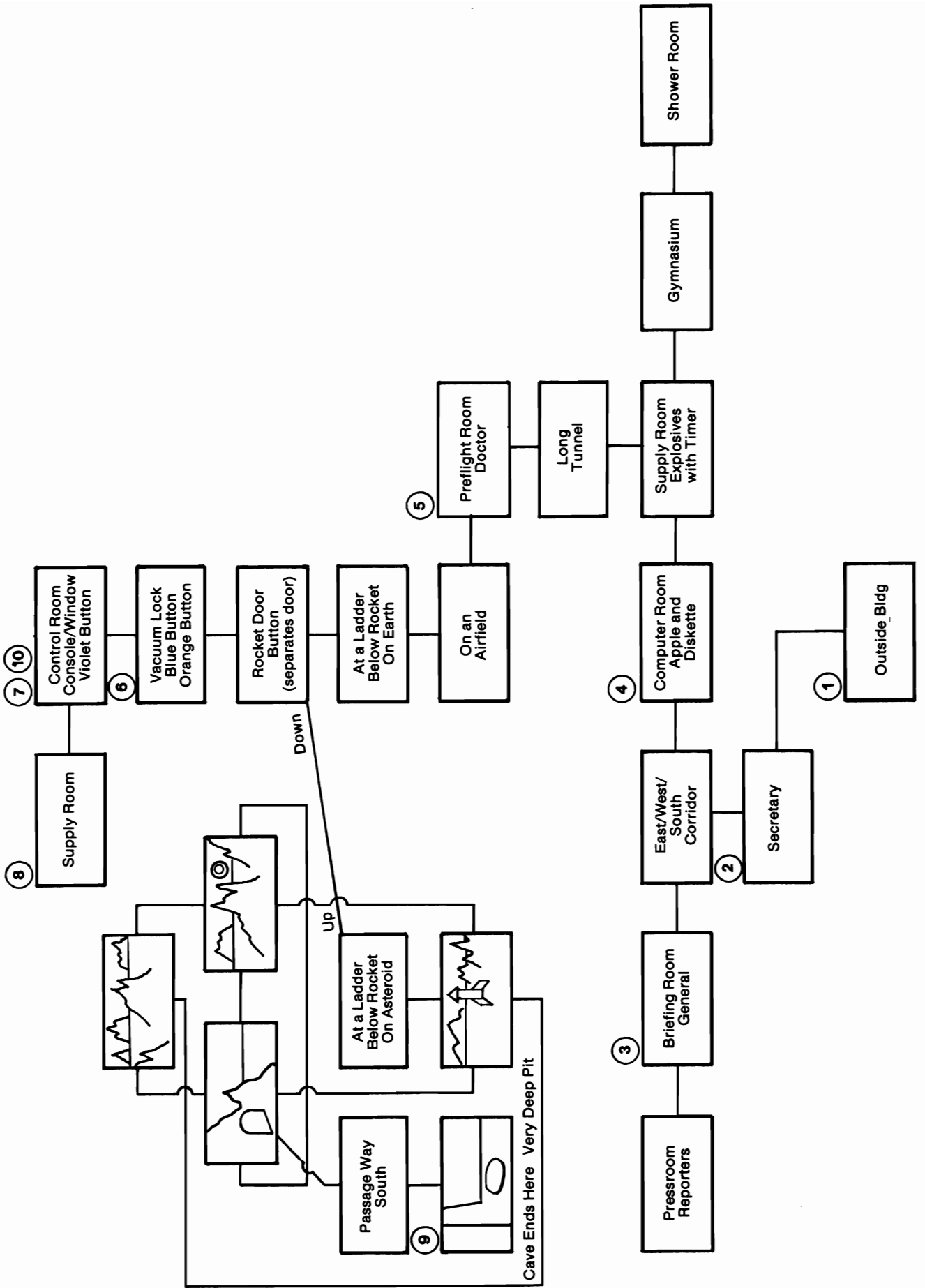

MISSION IMPOSSIBLE

Company: Adventure International

Suggested Retail: \$39.95

Type: Originally an all-text game, recently re-released in Hi-Res form.

Description:

You must stop the Saboteur from bombing the Nuclear Reactor. To complicate matters, you are a walking time-bomb, and the saboteur dies before you get very far. You must enter three differently colored rooms in a specific sequence. The ending can be a real blast.

Playability:

One of the easier games in the series, with not too difficult and quite straightforward puzzles. The game is sort of fun while it lasts, but it doesn't last all that long. The two-word syntax has a limited but adequate vocabulary. The text is brief and to the point. The game offers a single, easily made or recalled saved-game.

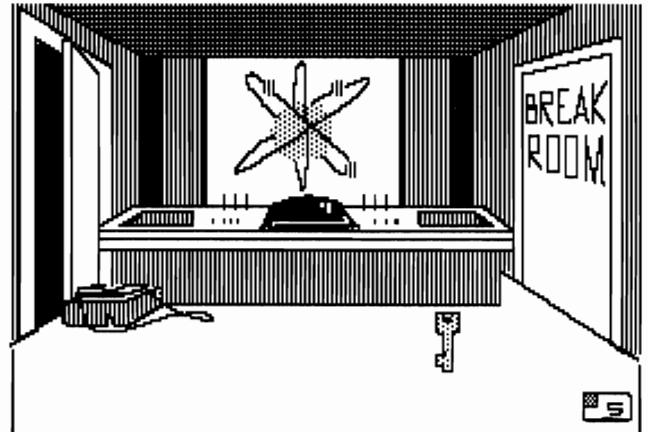
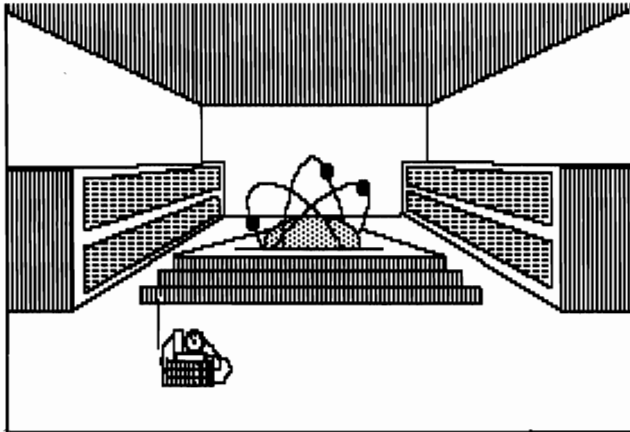

MISSION IMPOSSIBLE

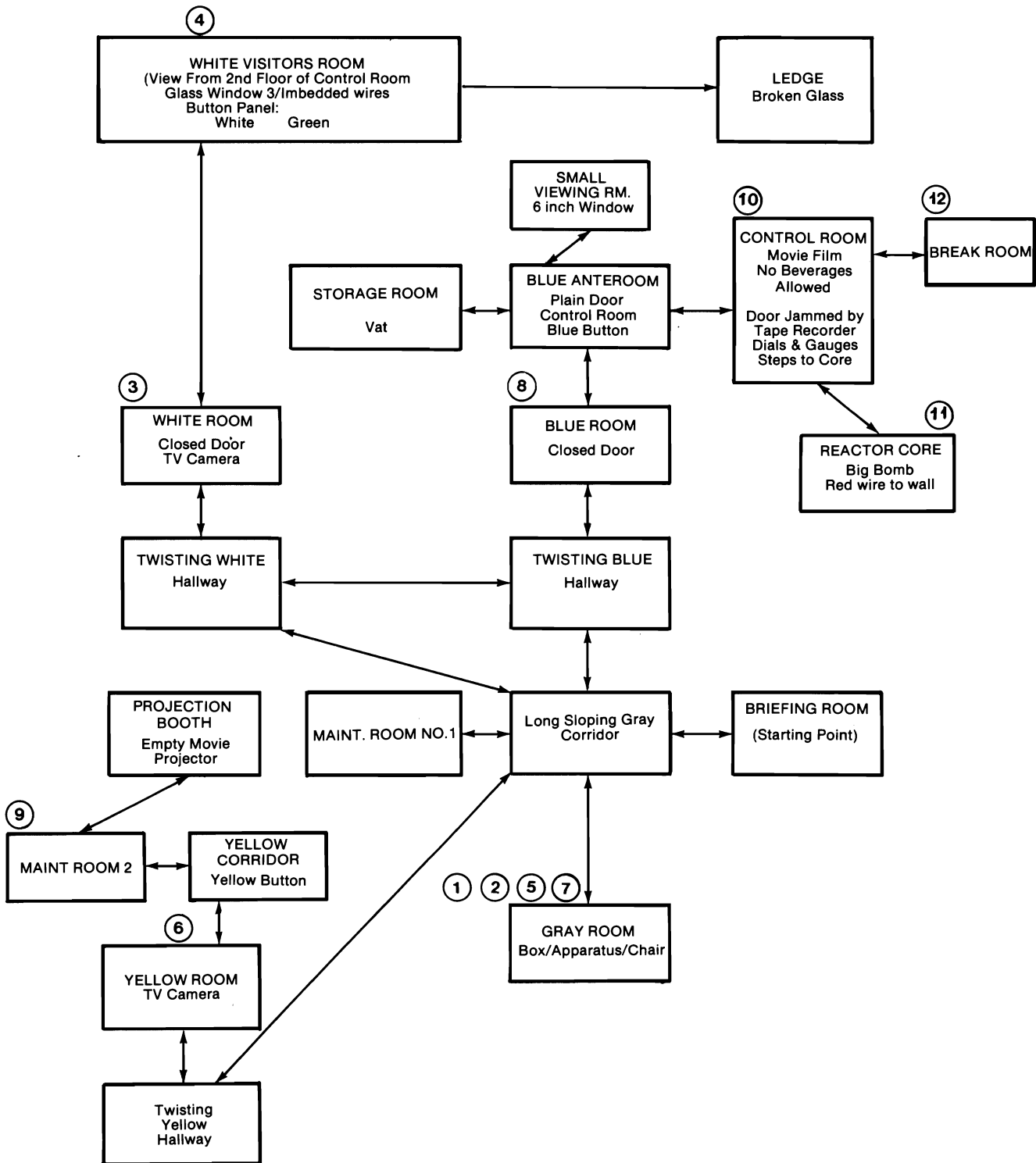

MUMMY'S CURSE

Company: Highland Computer Service

Suggested Retail: \$30.00

Type: Hi-Res adventure with color graphics.

Description:

Find the solid gold burial mask and return it to the starting point. Doing so involves finding and using three amulets, a little woodwork, and the waving of a scepter.

Playability:

The mummy and a few fixed traps pose little difficulty once you have mapped and understood the game. The game holds your interest easily, largely because of the excellent save-game implementation. The game has little in the way of plot, and the vocabulary is poor, but all in all it rates as an average adventure suitable for beginning to intermediate players.

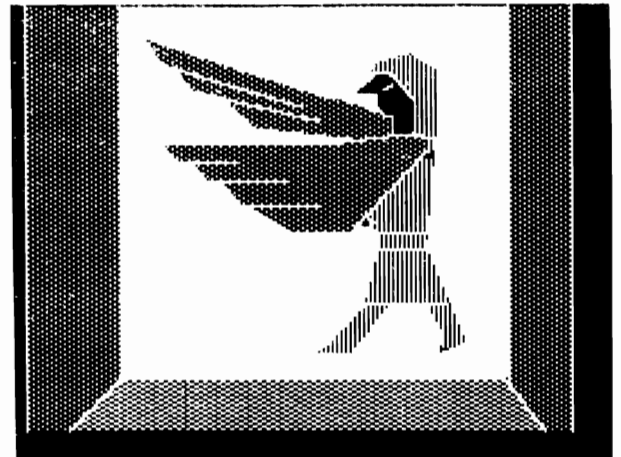
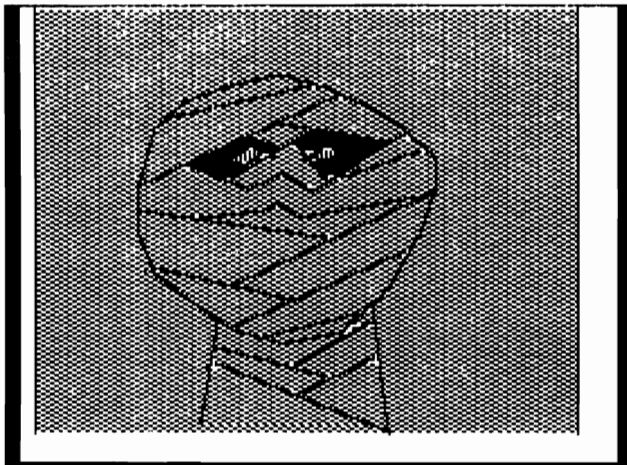

MYSTERY FUN HOUSE

Company: Adventure International

Suggested Retail: \$39.95

Type: An all-text game, soon to be revised into a Hi-Res version. Price also includes *Pyramid of Doom* and *Ghost Town*.

Description:

Spies have hidden secret plans that you must retrieve from a carnival Fun House. Water Maidens, Shooting Galleries, Carousels, Weird Windows and a slew of locked doors await you. The puzzles, marked by a high degree of imagination, are devilishly clever.

Playability:

A lot of fun to play, challenging to unravel, difficult to bring to a successful conclusion—and my choice for the best of Scott Adams' twelve original games. The two-word syntax has a limited but adequate vocabulary. The text is brief and to the point. The game provides a single, easily made or recalled saved-game.

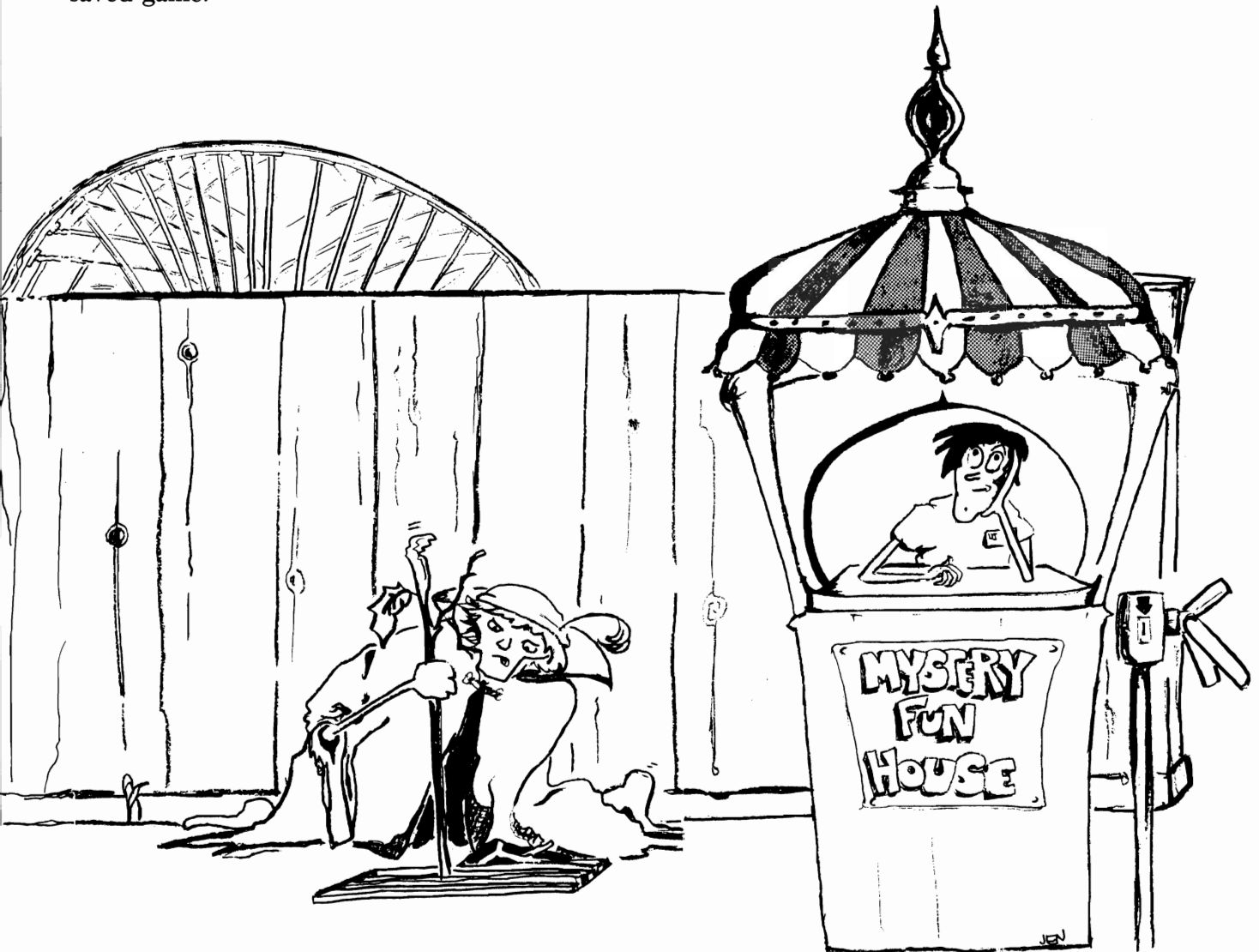

MYSTERY HOUSE

Company: On Line Systems

Suggested Retail: \$24.95

Type: Hi-Res adventure.

Description:

Based loosely on the Agatha Christie novel, *The Ten Little Indians*. You have the dual task of trying to find the treasure hidden somewhere in the house and deducing the identity of the baddy. Unfortunately, he keeps murdering the other suspects and even tries to kill you.

Playability:

Not a long game. The mansion has only two stories. The vocabulary is limited and uses only a standard two-word parser. The graphics of rooms and objects appear as black and white line drawings. You do get a save-game option, however. All in all, it's a fun game for beginning and intermediate adventurers, and is noteworthy as the first of the Hi-Res adventures.

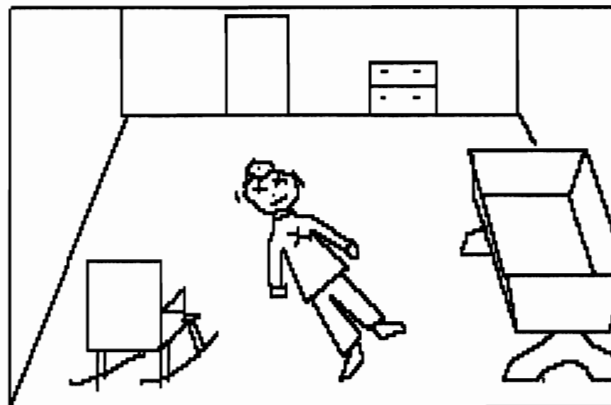
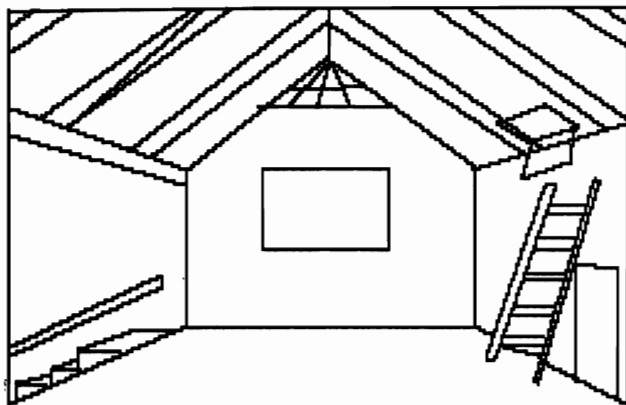
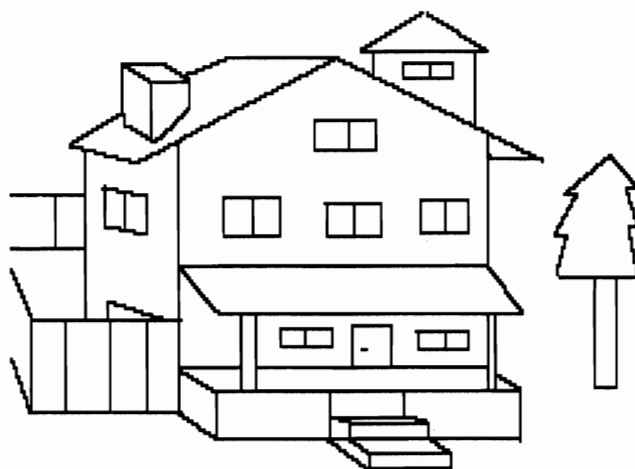

MYSTERY HOUSE

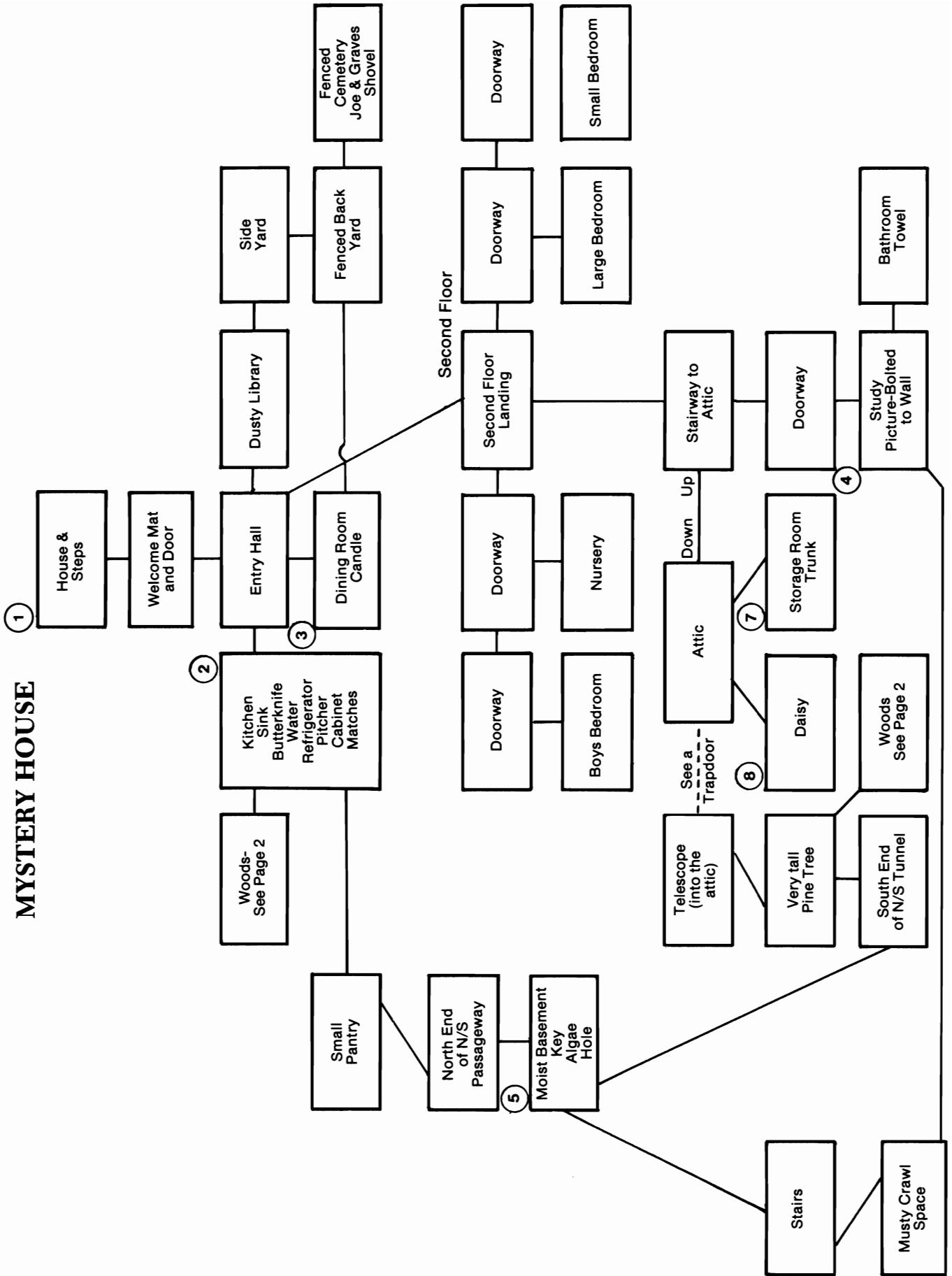

MYSTERY HOUSE

Forest Maze

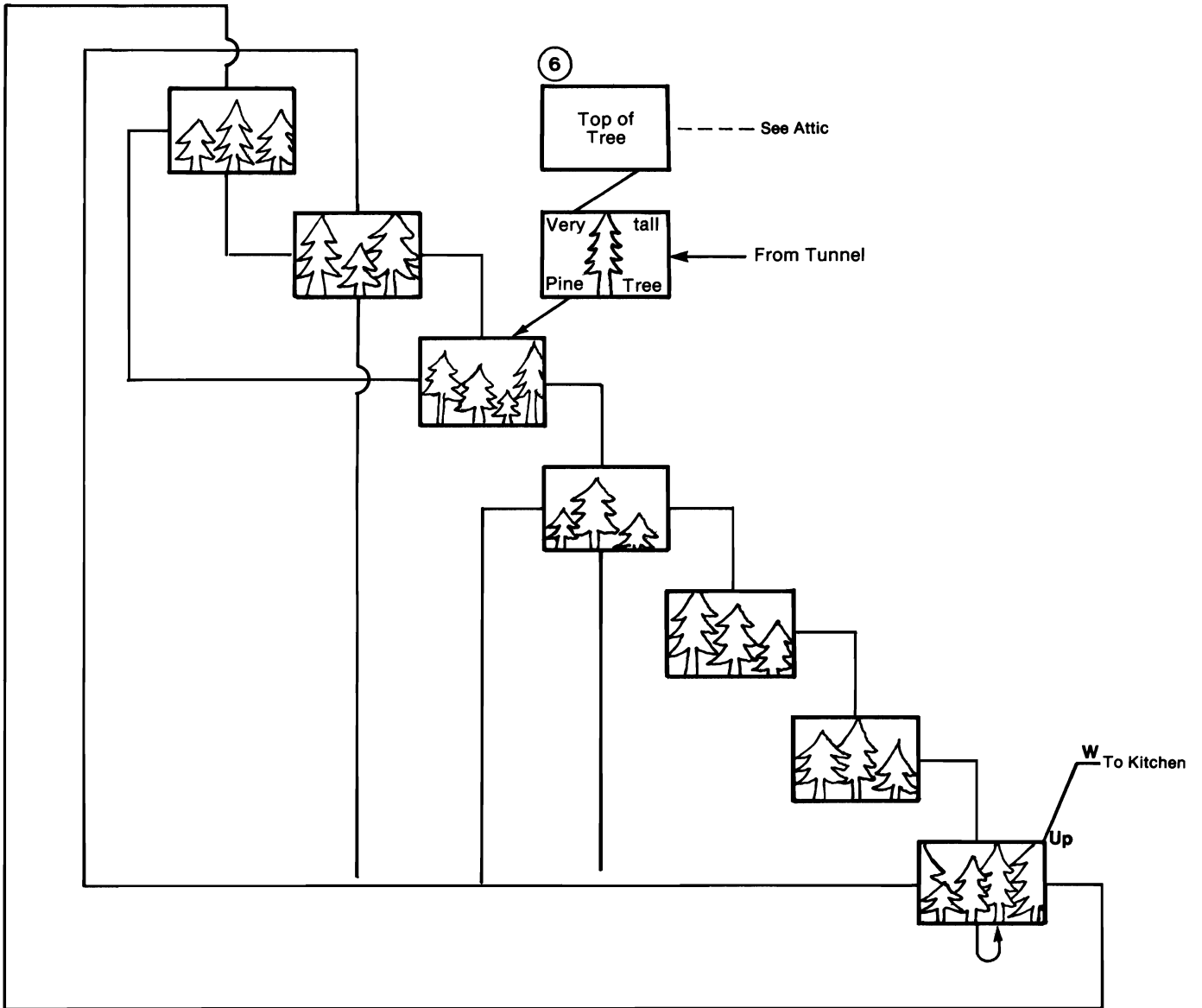

OLDORF'S REVENGE (WIZARD I)

Company: Highland Computer Services

Suggested Retail: \$19.95

Type: Black and white Hi-Res adventure.

Description:

You simply need to find the fourteen scattered treasures that lie about in the four linked, but otherwise independent, game segments. You must choose which of the seven types of characters you wish to become in order to solve specific puzzles. The management of each character's limited "lives" makes up a large part of the challenge. The graphics are only average, but the text gets rather clever in places, especially at the end.

Playability:

A barely average adventure, but a good one for first time adventurers. It will serve the more experienced player as a pleasant way to pass time. After reaching the second segment of the game, you may save it. The vocabulary is not very good; in fact, it's very poor, but at least you don't get killed off at every corner.

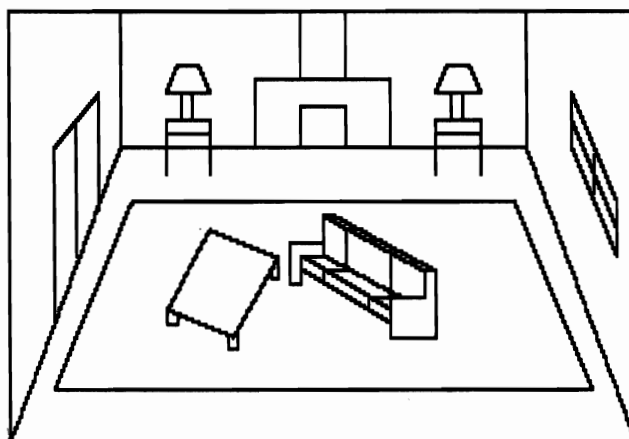
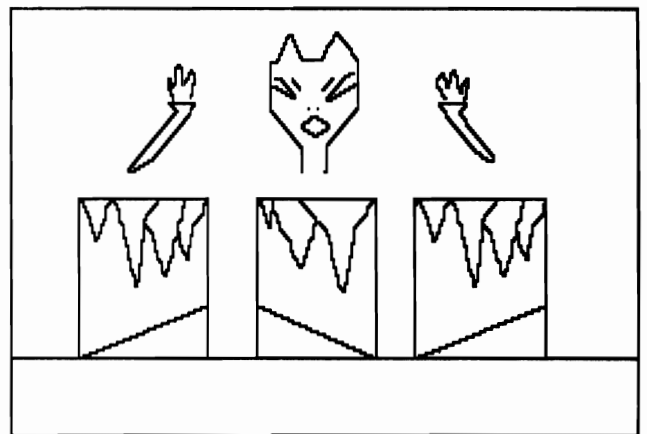
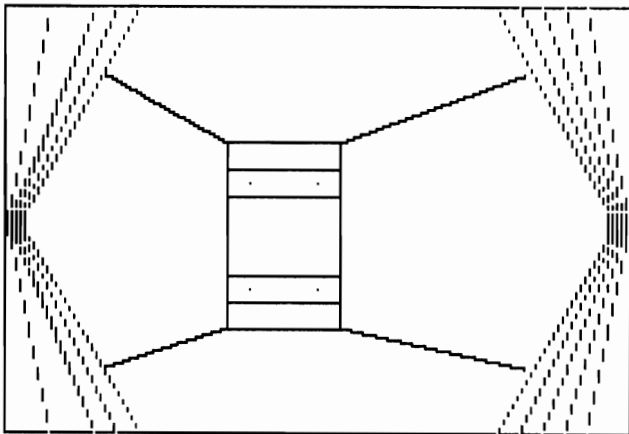

OLDORF'S REVENGE (WIZARD I)

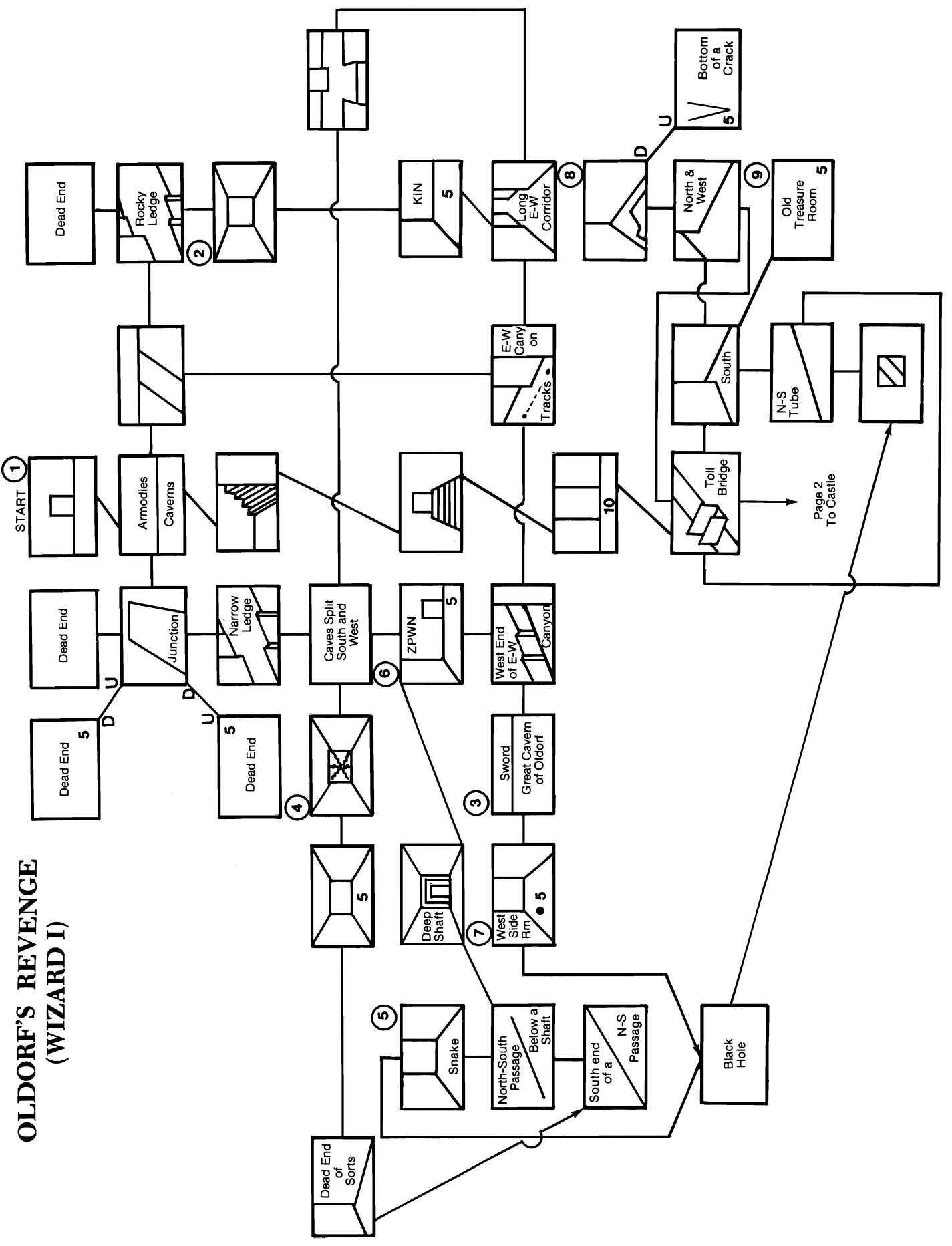

OLDORF'S REVENGE

Part 2

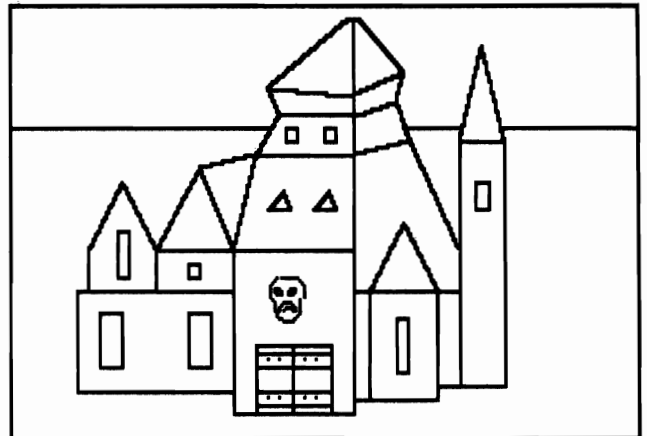
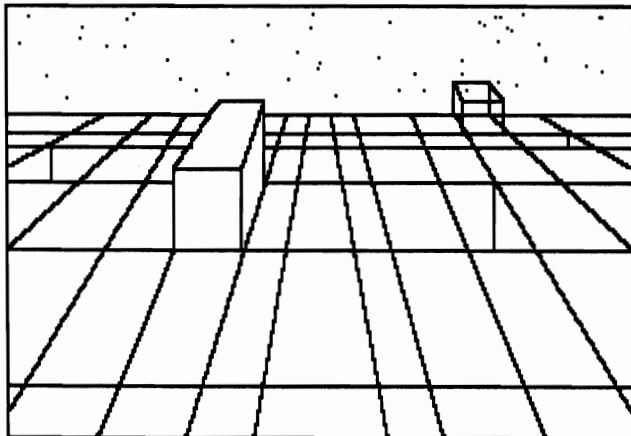
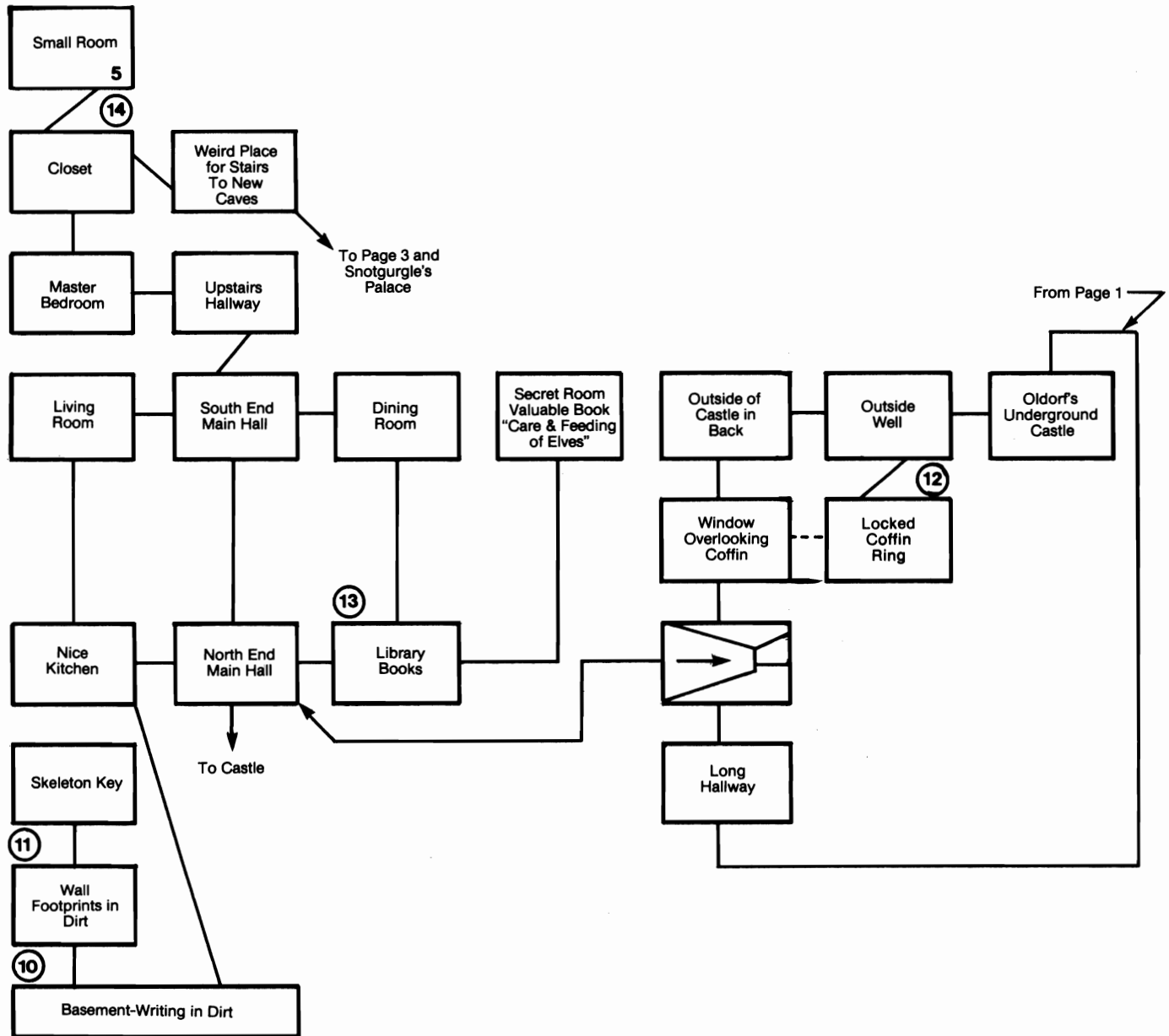

OLDORF'S REVENGE

Part 3

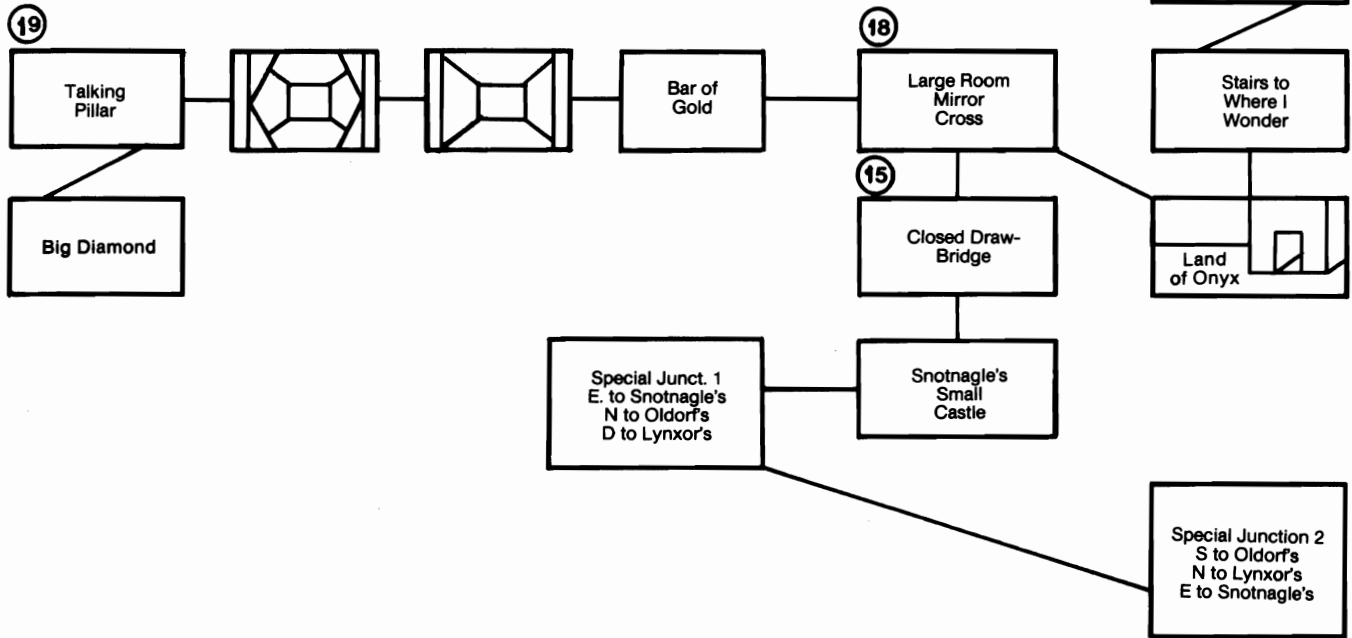
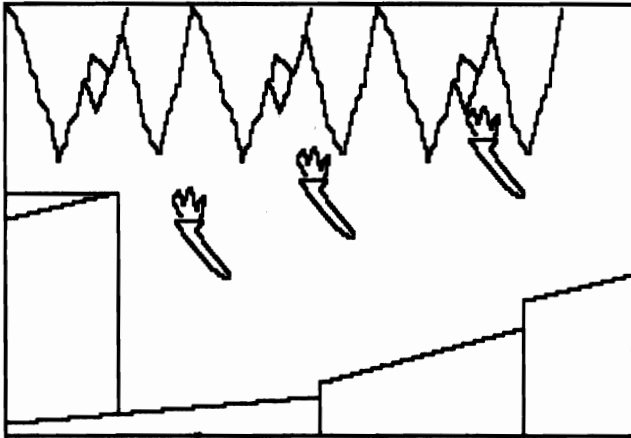

(See Page 4)

OO-TOPOS

Company: Sentient Software

Suggested Retail: \$32.95

Type: All-text adventure of the futuristic variety. Like, way out!

Description:

Escape from an alien planet and return to Earth after reassembling the widely scattered parts of your spacecraft and finding the various treasures which were in the spacecraft at the time of your capture. The jungle maze, one of five in the game, is excellent.

Playability:

A high degree of disk interaction slows *OO-Topos*, already lengthy and somewhat difficult, largely because of its size and the number of discrete objects. Most likely, only experienced adventurers will have the patience to play it through. The vocabulary is limited, and the scoring a complete mystery. Still, overall, it's an above average game, a challenging adventure with excellent scope and story line.

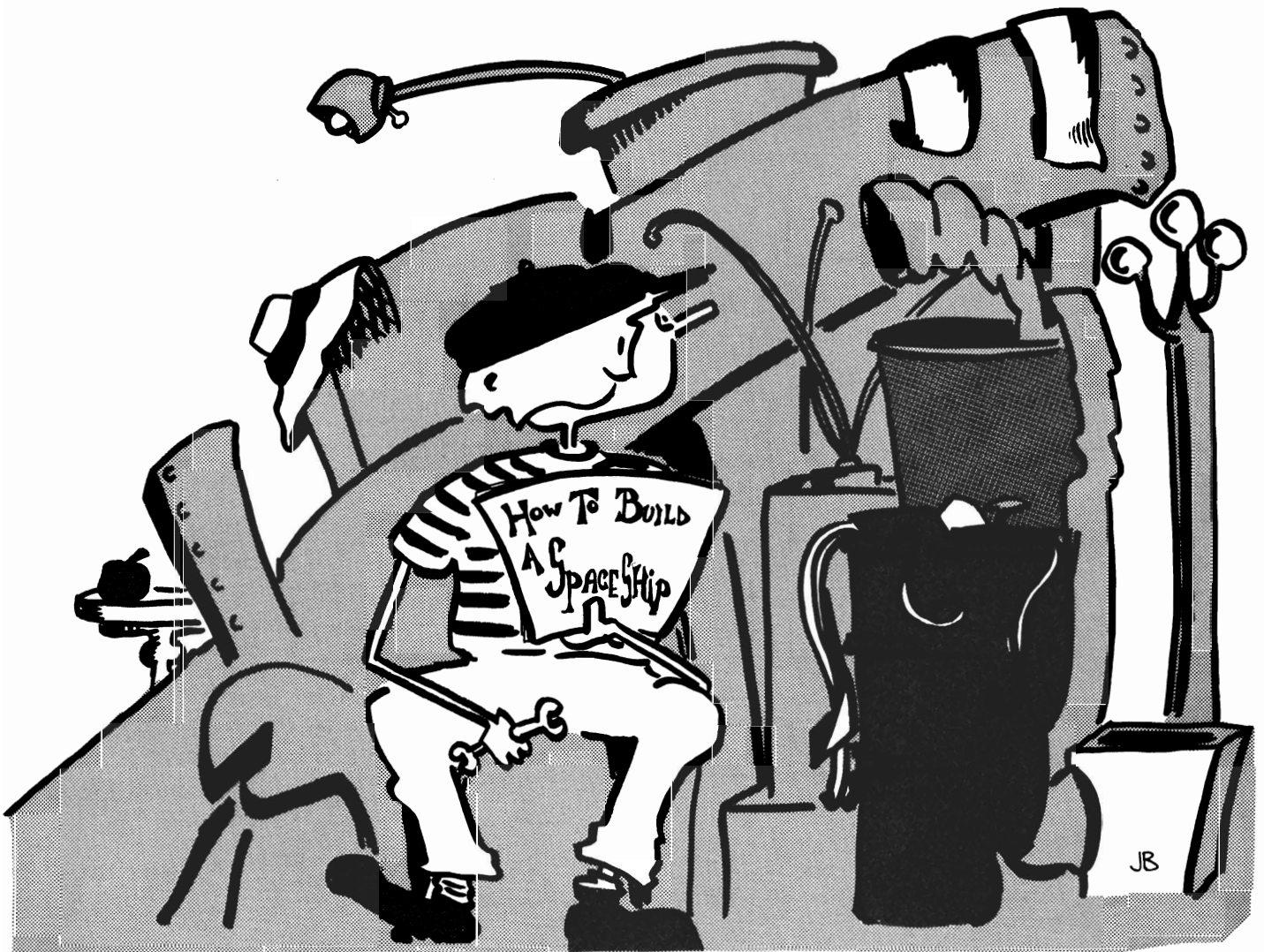

OO-TOPOS Part I

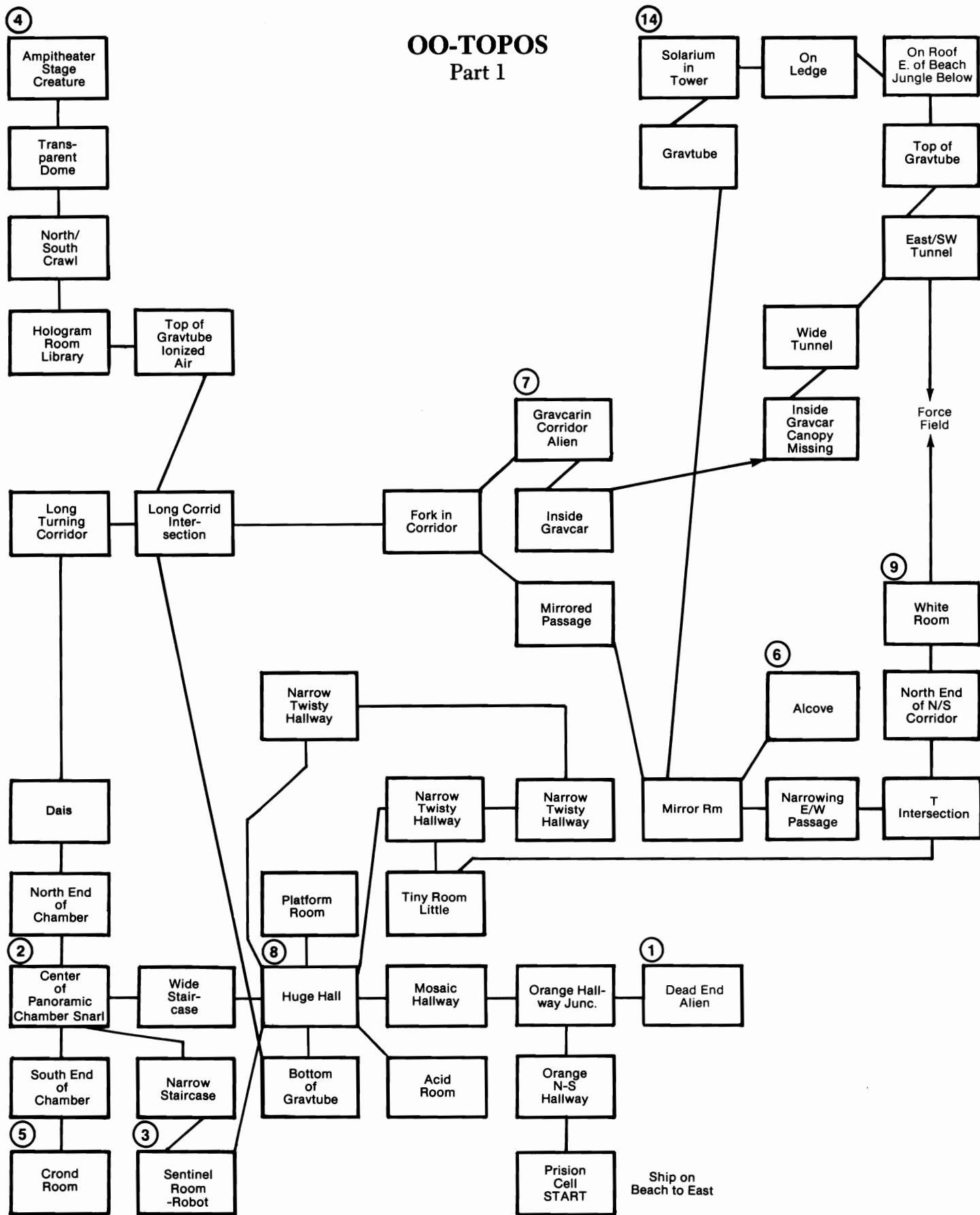

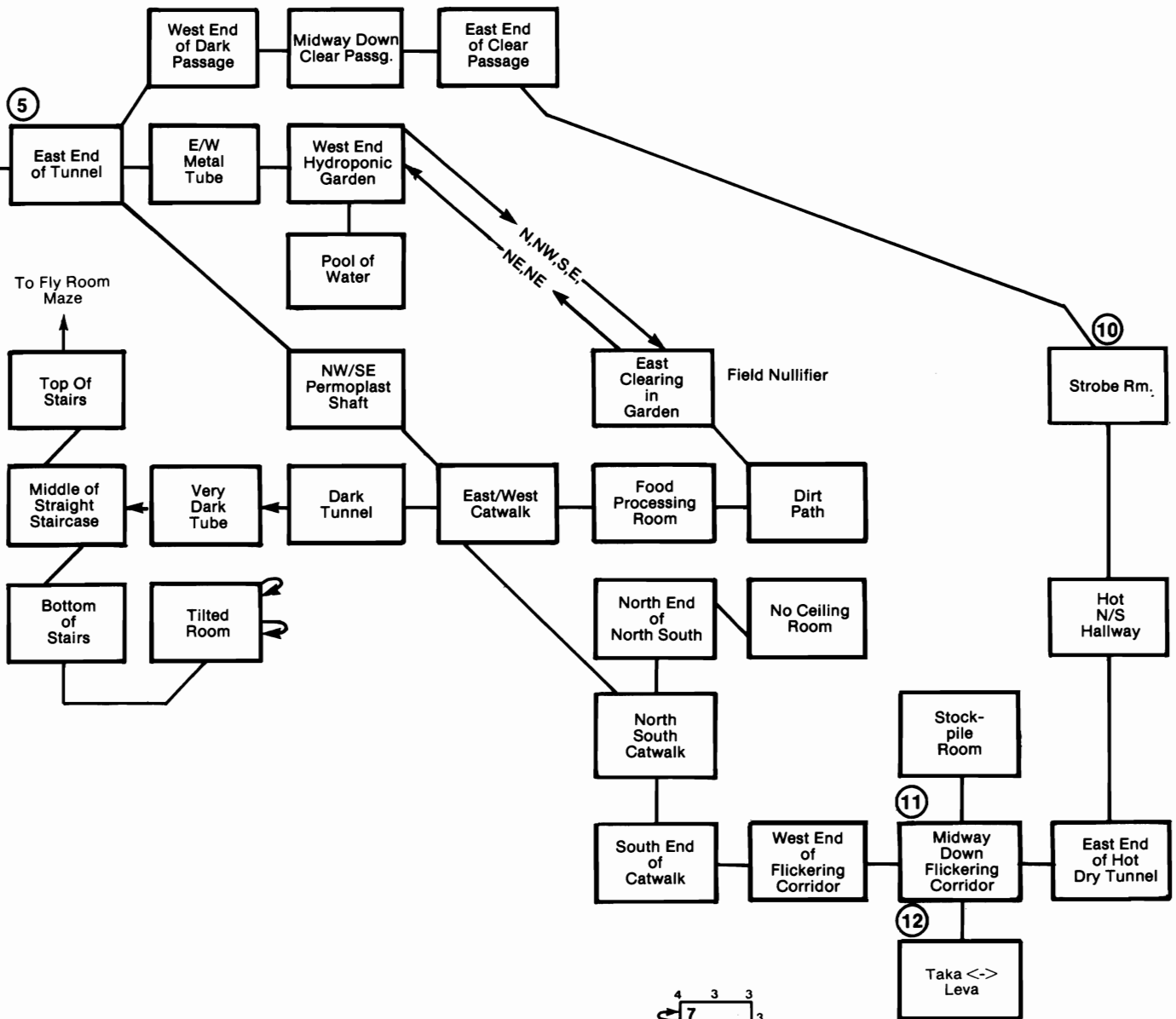

Hydroponic Garden Maze

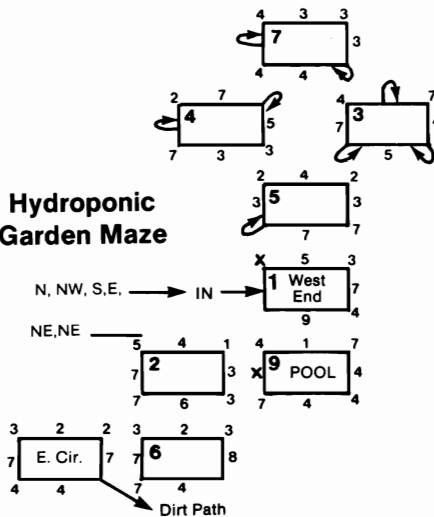

OO-TOPOS

Part 2

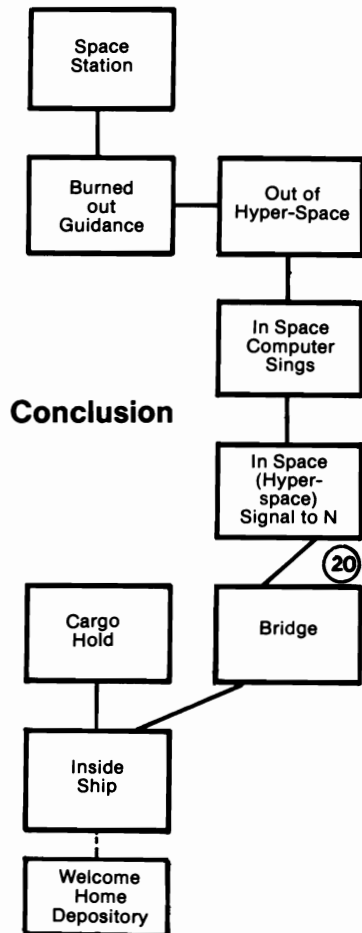
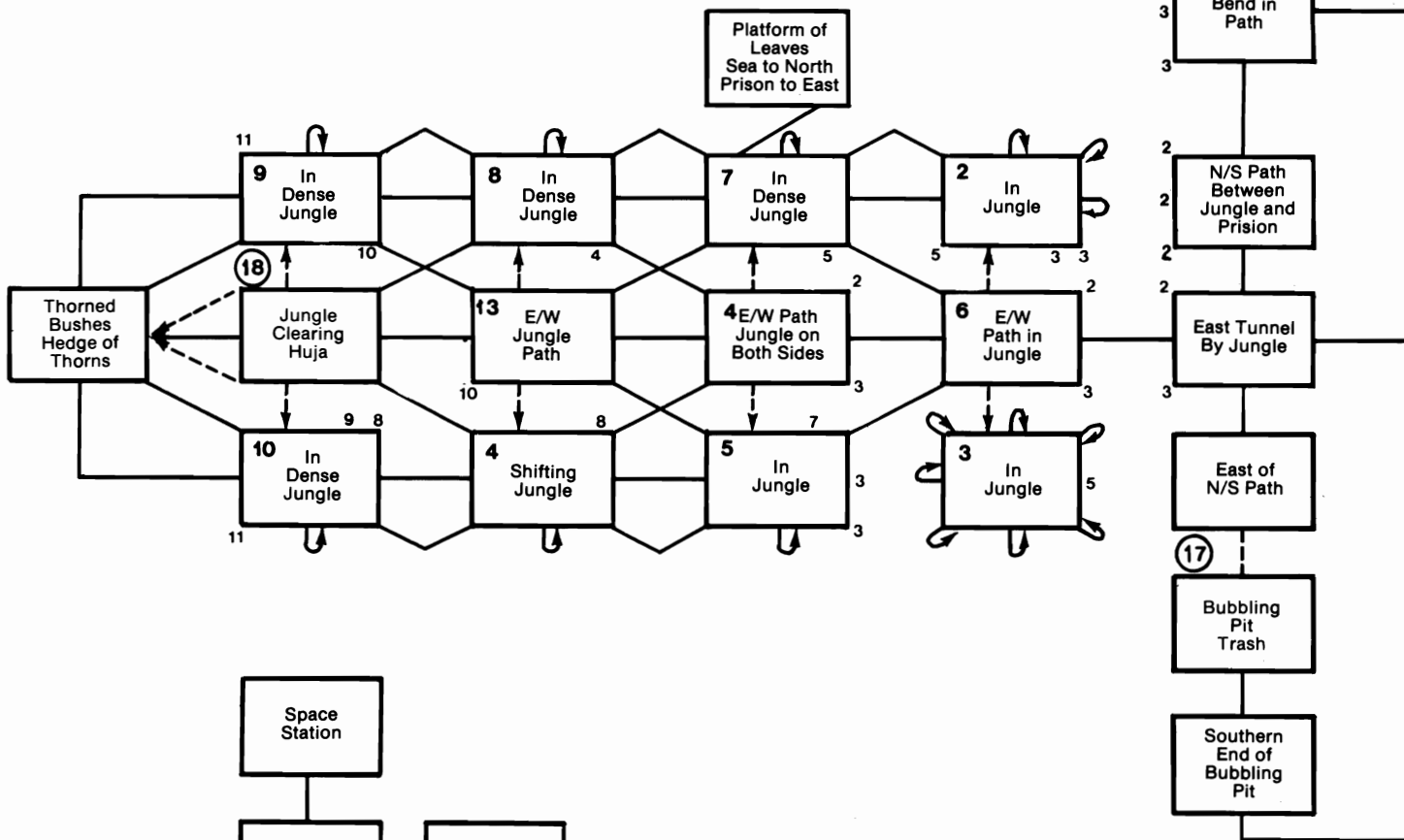

Conclusion

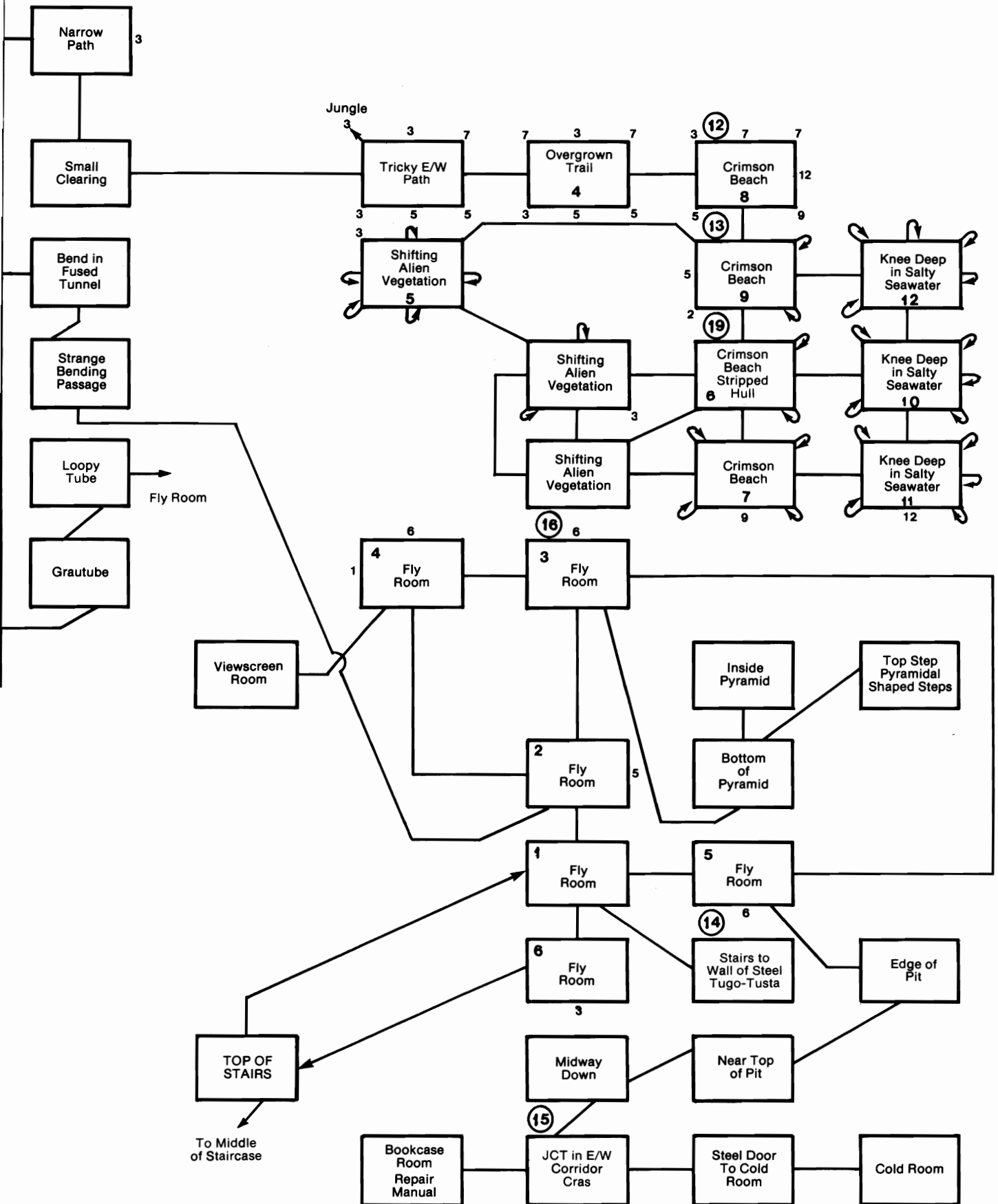

PALACE IN THUNDERLAND

Company: Micro Lab

Suggested Retail: \$24.95

Type: All-text adventure.

Description:

Palace in Thunderland, Micro Lab's second adventure, follows the successful *Madventure*. You must find eight treasures and resolve several puzzles. The story follows an *Alice in Wonderland* theme, very much tongue-in-cheek, with lots of humor. Who knows, you may become the King!

Playability:

An excellent game. Humor, a reasonable vocabulary and one puzzle in particular that has several viable alternatives, but only one answer that will permit a perfect game. Beginners can handle *Palace*, but even more experienced adventurers will take a good weekend to get through it.

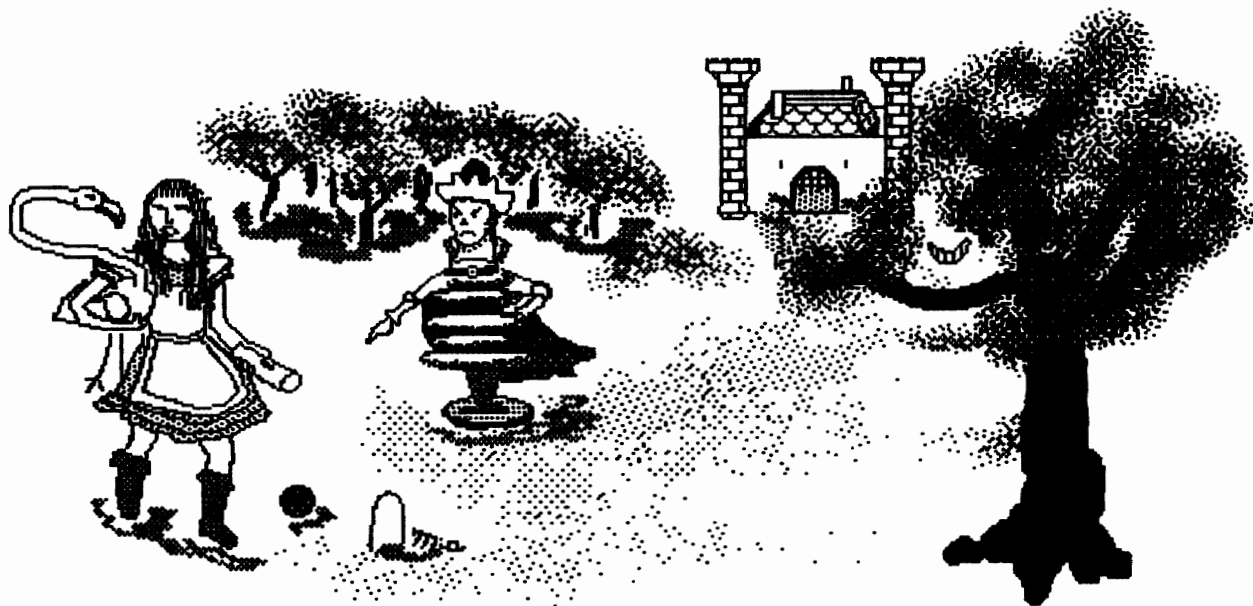

PALACE IN THUNDERLAND

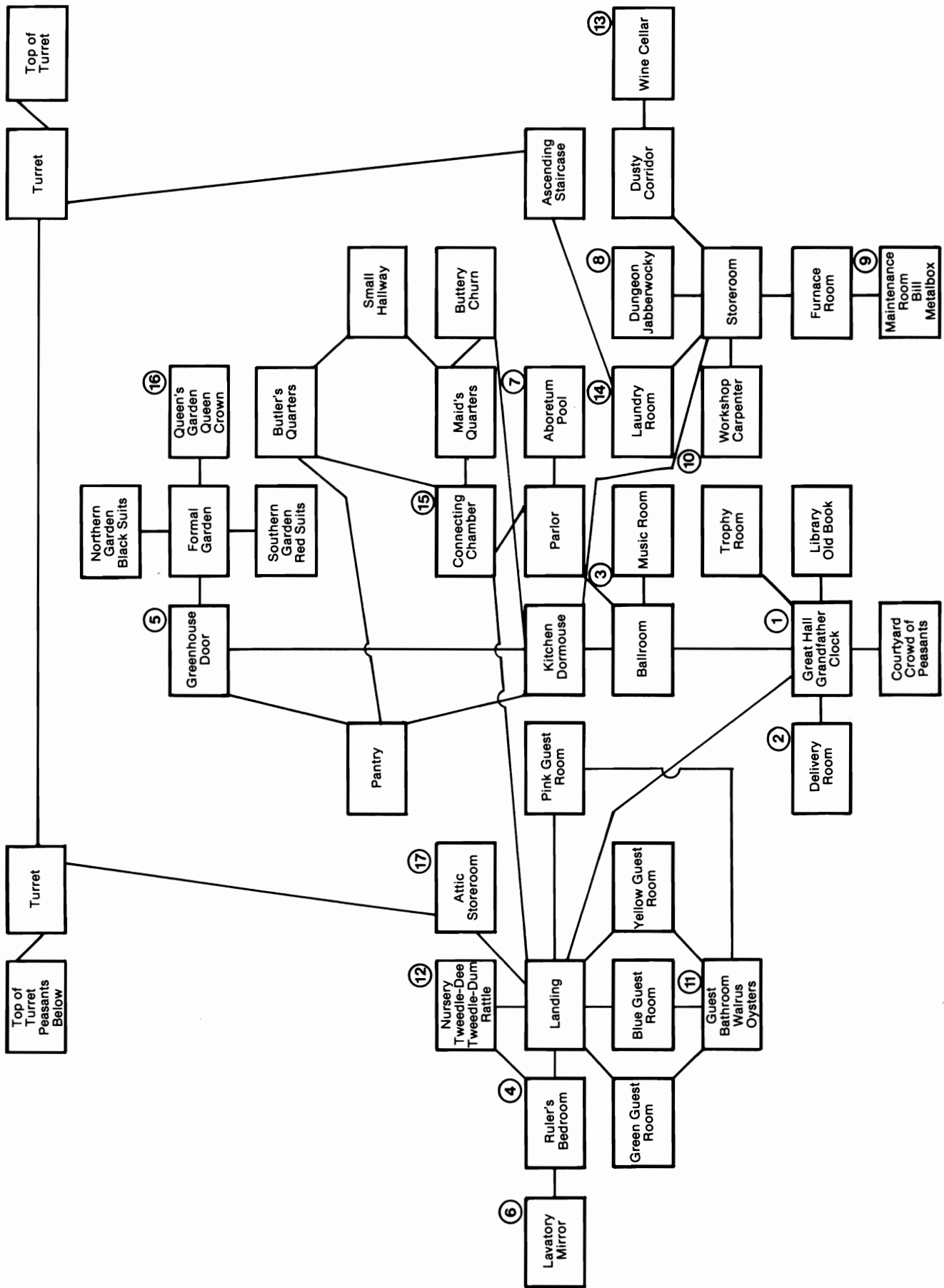

PIRATE ADVENTURE

Company: Adventure International

Suggested Retail: \$39.95

Type: Originally an all-text game, recently re-released in Hi-Res form.

Description:

You must magically travel between a London flat and an island on your way to locating two treasures. It has a smooth storytelling style, and rooms are populated by such wacky characters as a talkative parrot, alligators, a mongoose that's a failure in life, and a drunken pirate who is forever wandering off.

Playability:

A good game to cut the young adventurer's teeth on; not too tough, and a lot of fun. The task of building a ship on the first island presents a good example of a well done interactive puzzle. The two-word syntax has a limited but adequate vocabulary. The text is brief and to the point. The game offers a single, easily made or recalled saved-game.

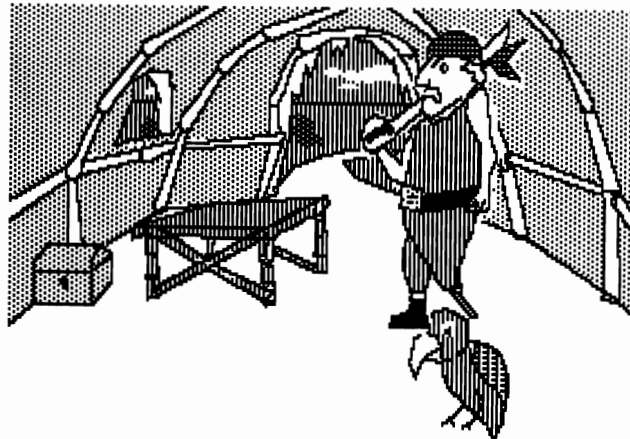
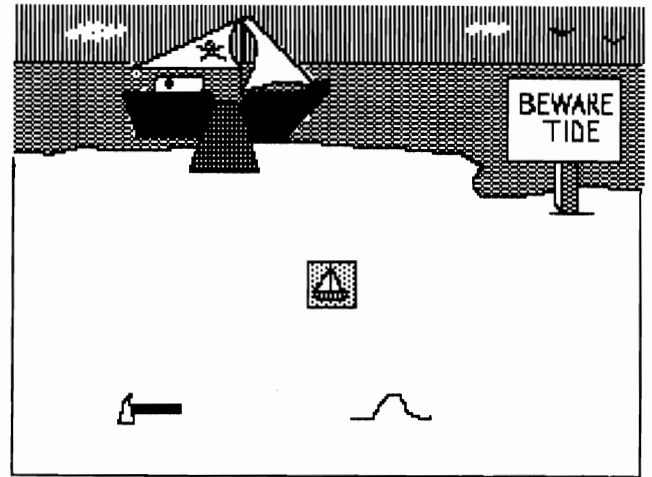
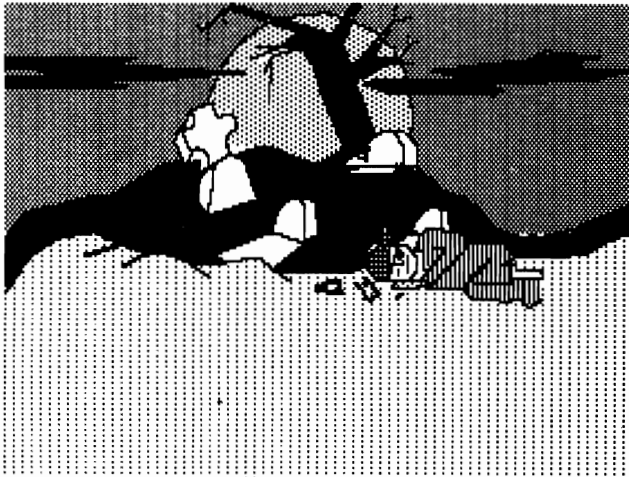

PIRATE ADVENTURE

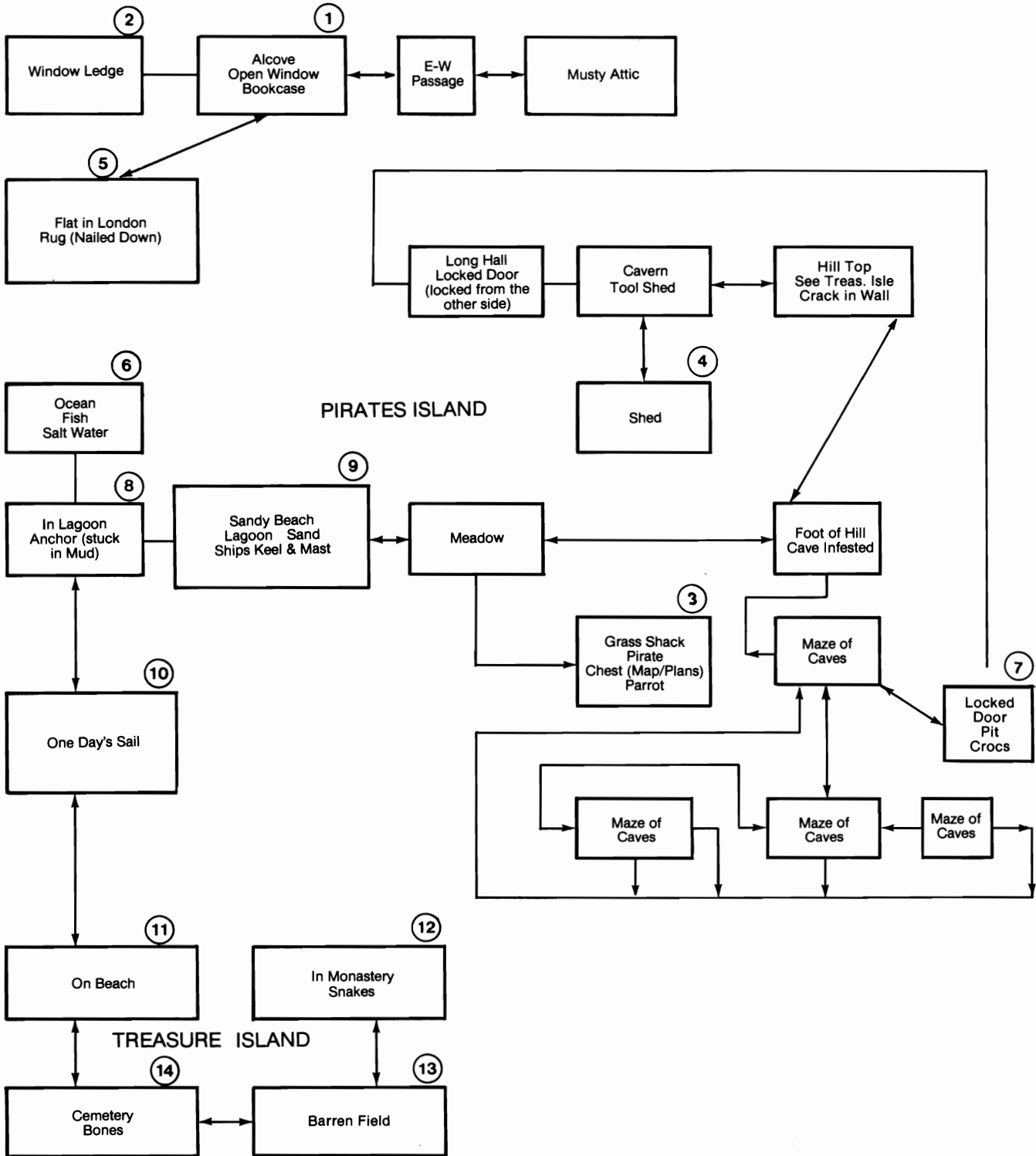

PLANETFALL

Company: Infocom, Inc.

Suggested Retail: \$49.95

Type: A science fiction all-text adventure.

Description:

After surviving an interstellar spaceship explosion, you find yourself on a strange planet, deserted except for a friendly robot named Floyd, who gives you his utmost devotion. The purpose of the game doesn't become clear until well into it, when you come across the computer-within-the-computer. To succeed, you need to repair four subsystems, overcome hunger and disease, battle a huge microbe, avoid radiation poisoning, and cope with a room full of dangerous mutants.

Playability:

Perhaps not as "tight" as some other games that Infocom has done, but reasonably challenging nevertheless. What with the "standard" superlative parser and save-game capability, it's a pleasure to play. You also get a few red-herring puzzles that are reasonably well developed, scads of objects to wonder about, and alternative endings that may make you wonder if you have achieved the optimum solution.

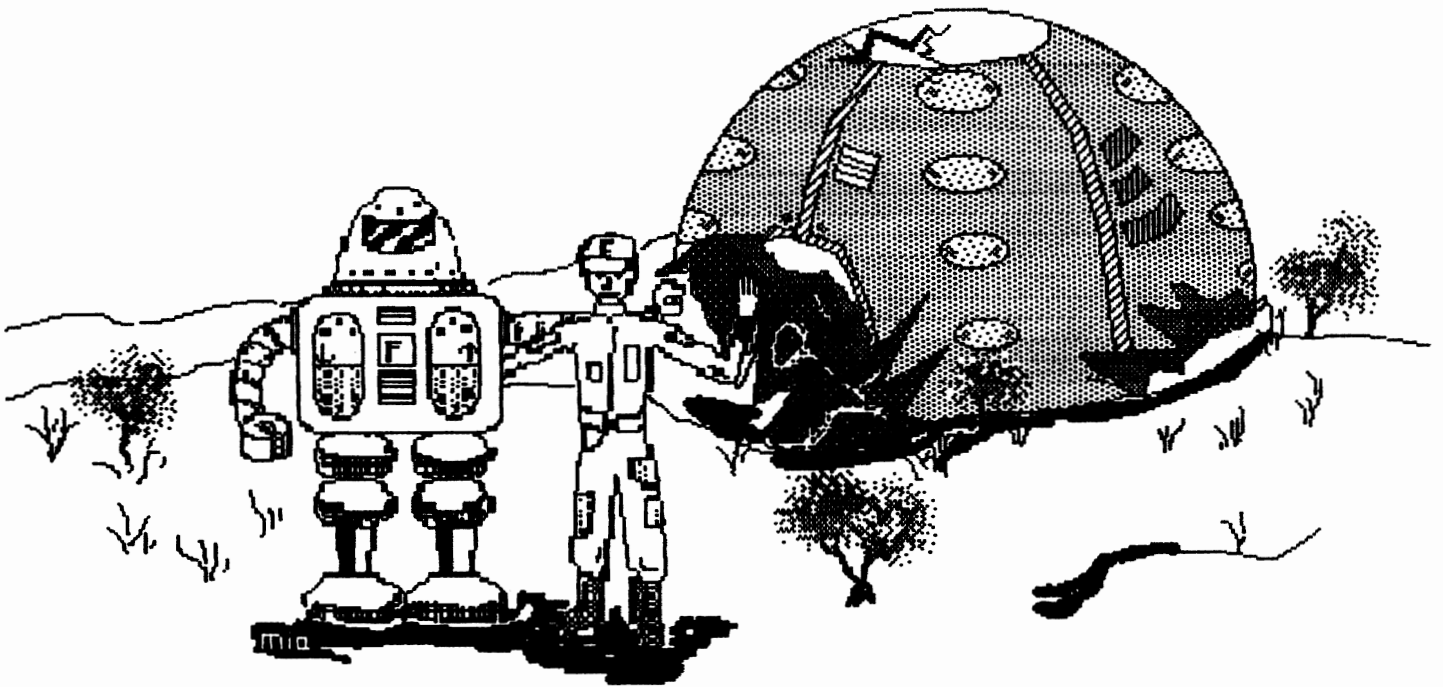

Floyd 'n Me

PLANETFALL

Part 1

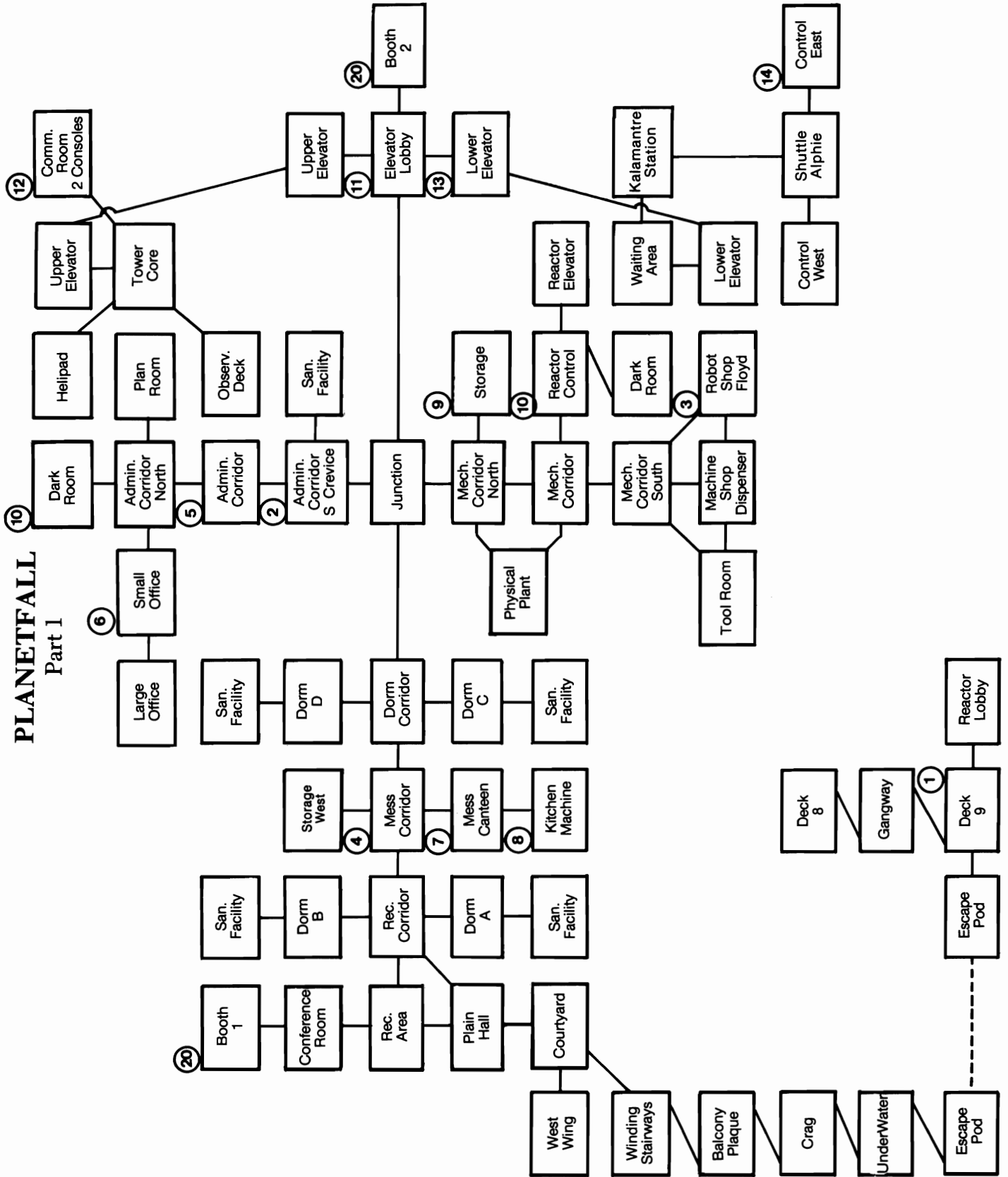

PLANETFALL Part 2

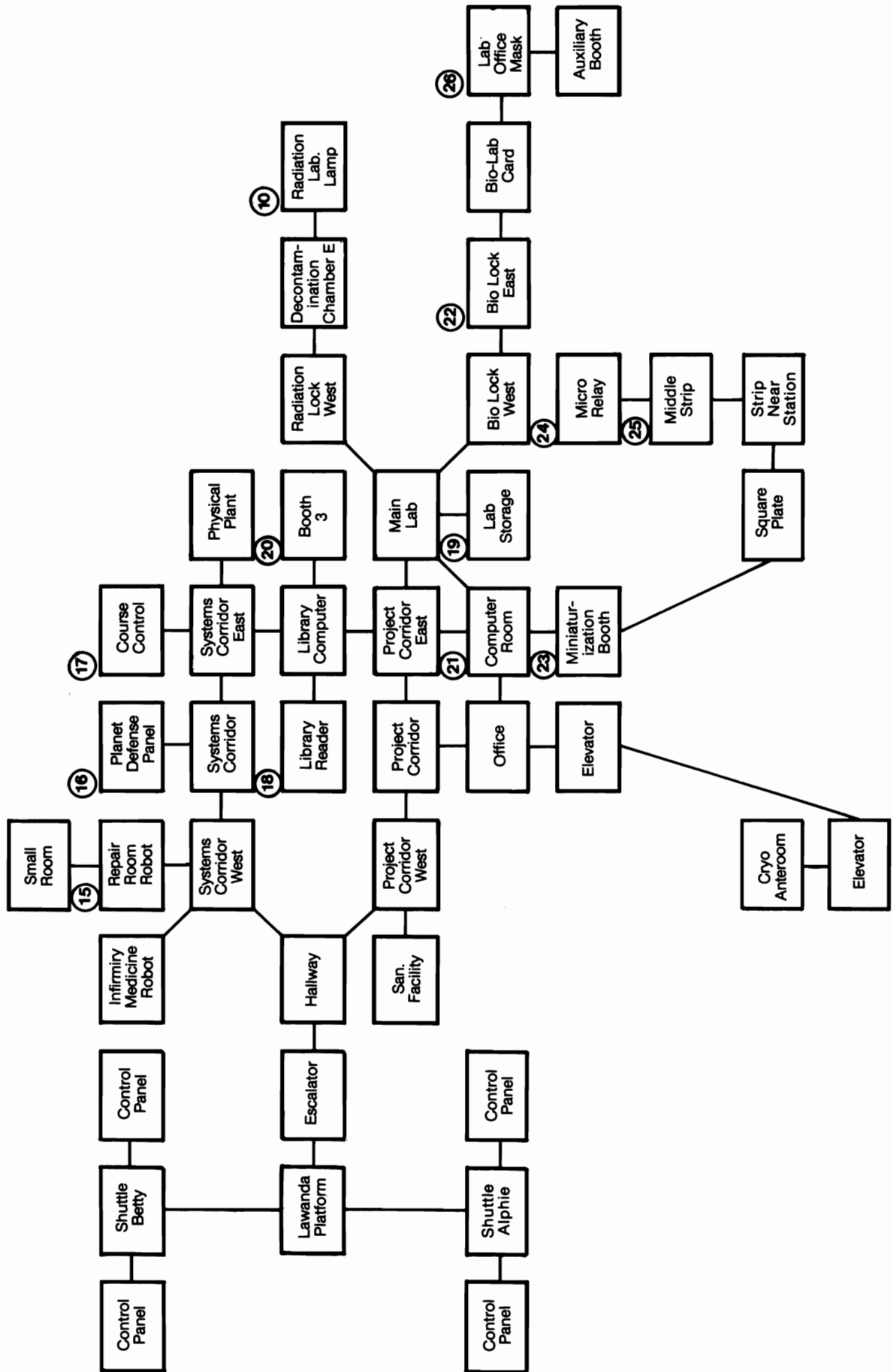

PYRAMID OF DOOM

Company: Adventure International

Suggested Retail: \$39.95

Type: An all-text game, scheduled for revision into Hi-Res form. Price also includes *Mystery Fun House* and *Ghost Town*.

Description:

Thirteen treasures lie scattered in an unexplored Egyptian pyramid. Your task: to get in, stay alive, and haul all thirteen back to a particular location. The game features cobras, mummies, pharaohs, decapitated statues, a huge purple worm, and a multitude of objects.

Playability:

This game starts out simply enough, but gets very difficult in a few spots; one treasure, for example, occupies a logical spot where you cannot see it, while another is guarded by a stone-hearted Iron Pharaoh. Have fun, and good luck with the purple worm. The two-word syntax has a limited but adequate vocabulary, and the text is brief and to the point. You also have a single easily made or recalled saved-game.

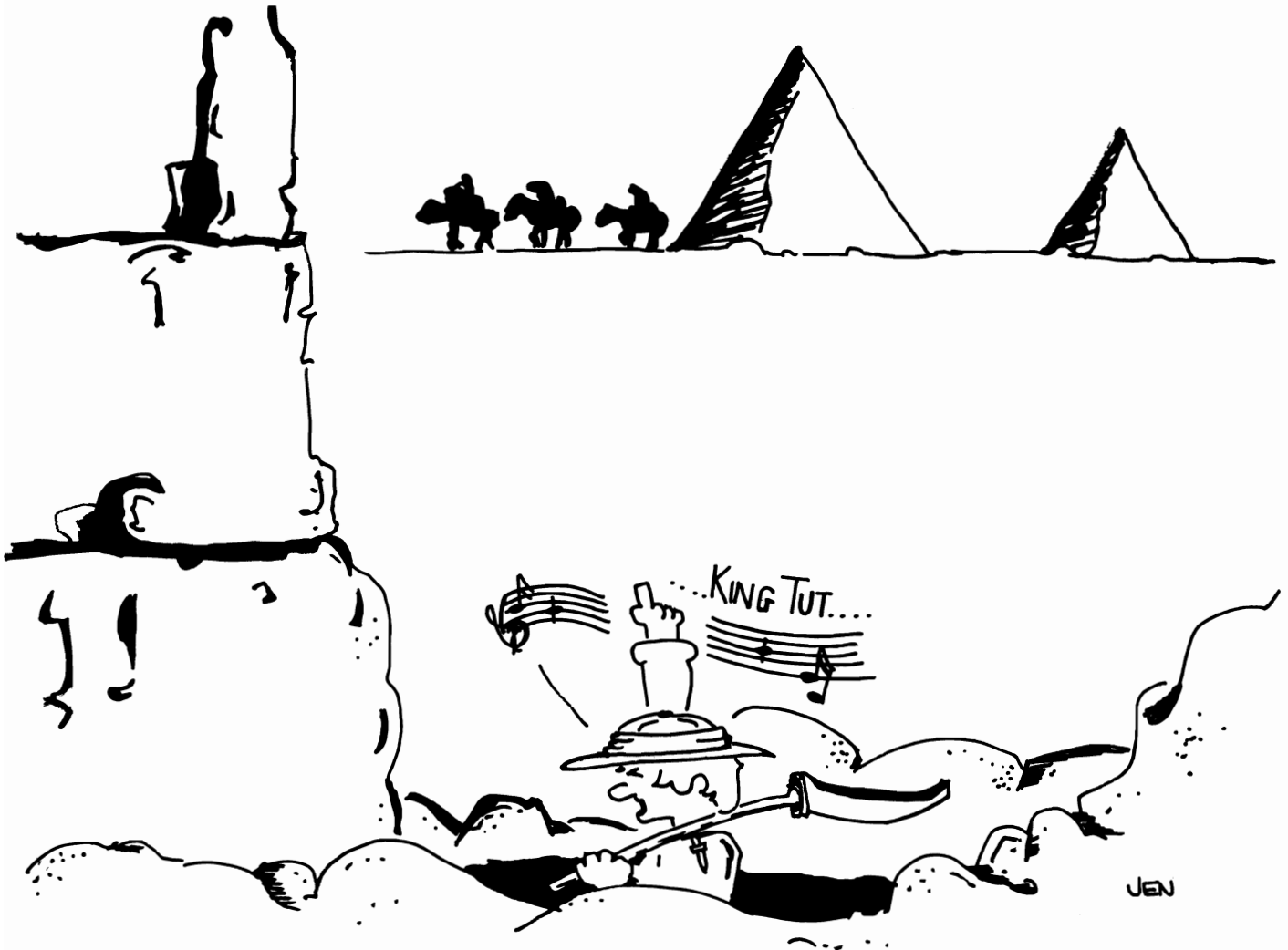

QUEEN OF PHOBOS

Company: Phoenix Software

Suggested Retail: \$34.95

Type: A black and white science fiction Hi-Res adventure.

Description:

As the sole occupant of a small spaceship, you must board a derelict Martian spaceship and obtain the fabled golden mask of Kuh-Thu-Lu. You must find it and make good your escape before the four looters who are also on board decide to do you in. If you can piece together some of the early-on puzzles, you can do them in before they conclude that you have to go. The graphics are crisp and well detailed.

Playability:

A well implemented, nicely paced, fast acting adventure of average difficulty. Beginners will find it challenging and interesting, and more experienced players will find an enjoyable weekend in store. You must traverse a good-sized maze in order to get to the center of the spaceship, where the real action takes place and a scary bit of animation occurs. The vocabulary proves quite adequate for the game, and clear responses answer unknown words.

QUEEN OF PHOBOS

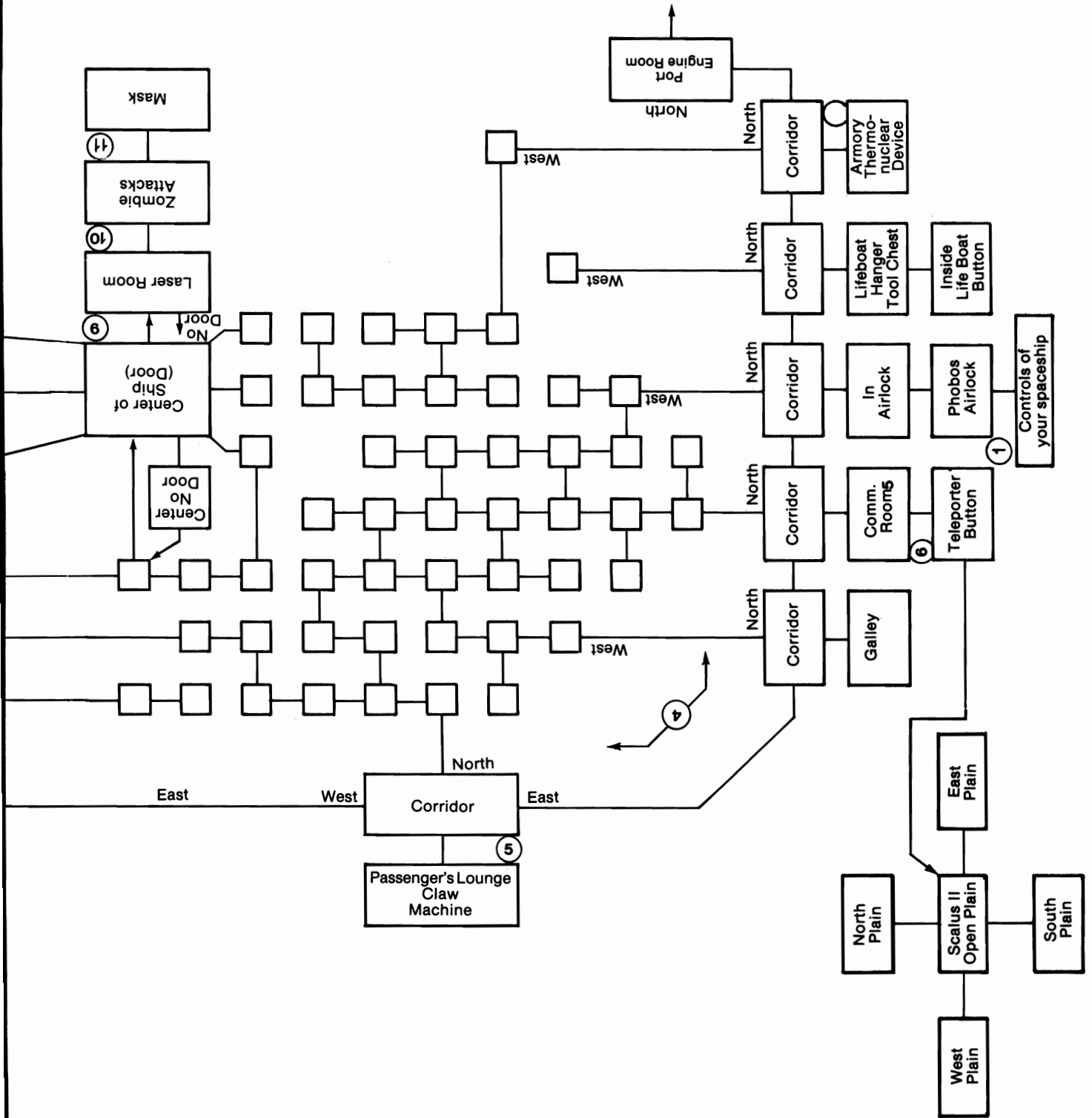

QUEEN OF PHOBOS

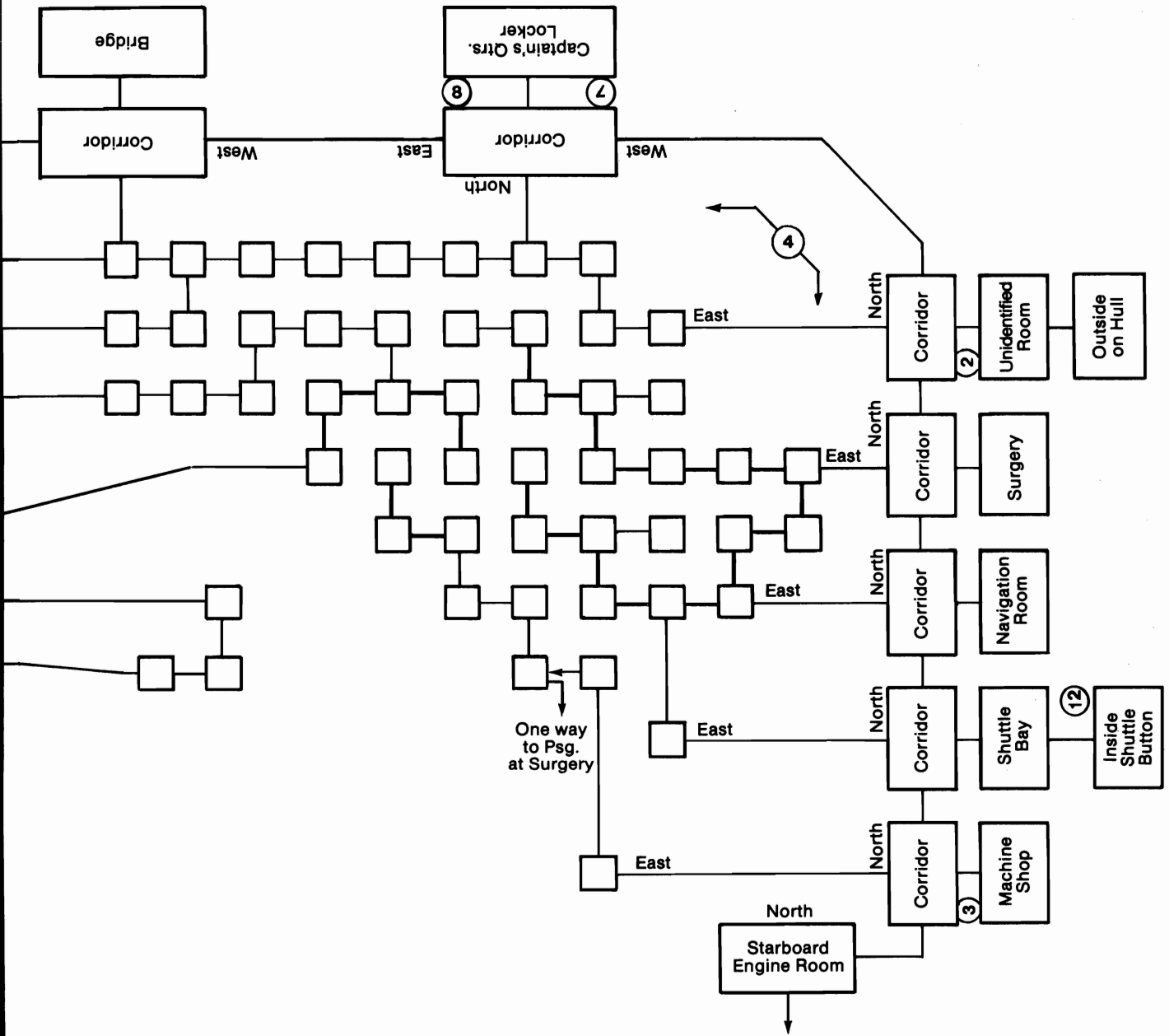

THE QUEST

Company: Penguin Software

Suggested Retail: \$19.95

Type: A Hi-Res adventure with color graphics.

Description:

This two-sided disk offers immense proportions, but little content. As the King's advisor, you been ordered to rid the kingdom of a rampaging dragon. Gorn, the King's loyal but slow-witted champion, accompanies you on this mission, which will have you ranging among blazing deserts, dark tunnels, and near endless plains.

Playability:

The graphics and text are rather insipid, except for the all too few glimpses of little Lisa. The vocabulary is terrible, and the "multiple-word" parser totally ignores any and all modifiers to verbs and nouns. A lot of seemingly unnecessary disk-swapping goes on, what with the saved-games going to a scratch disk and all.

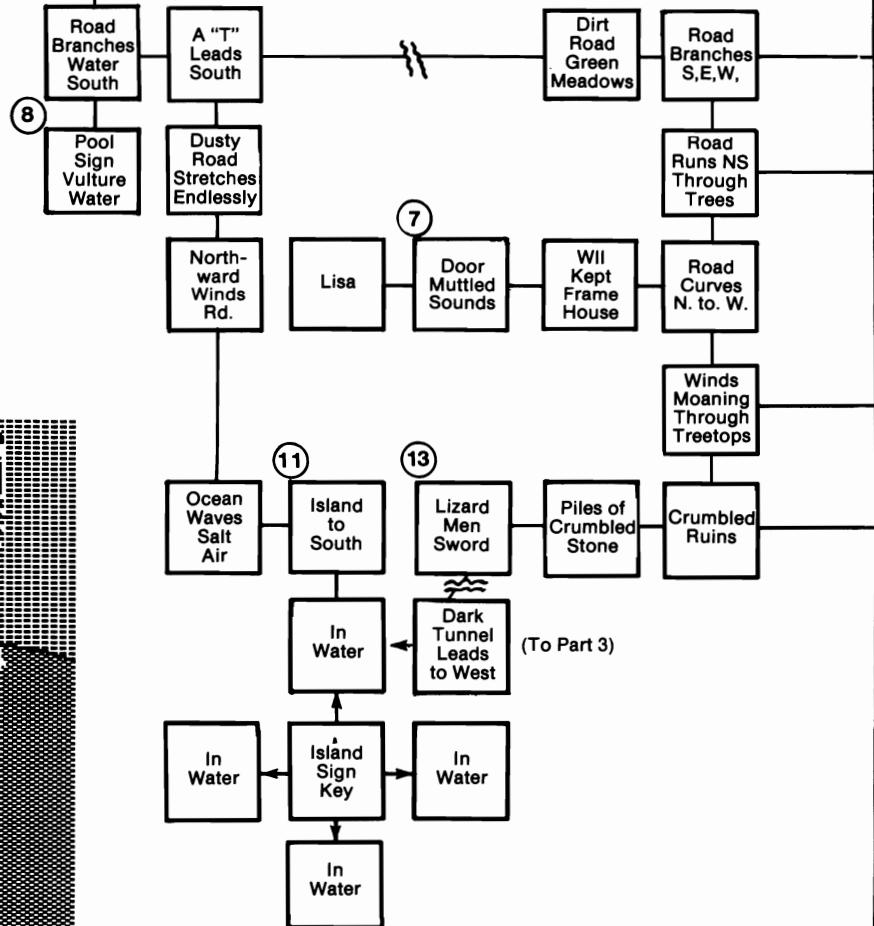
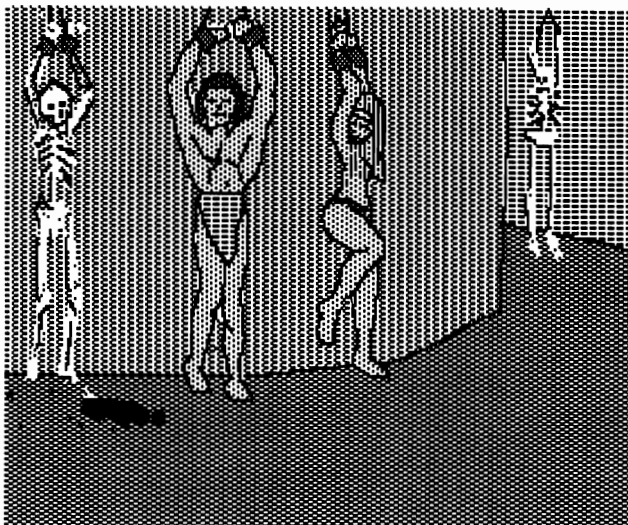
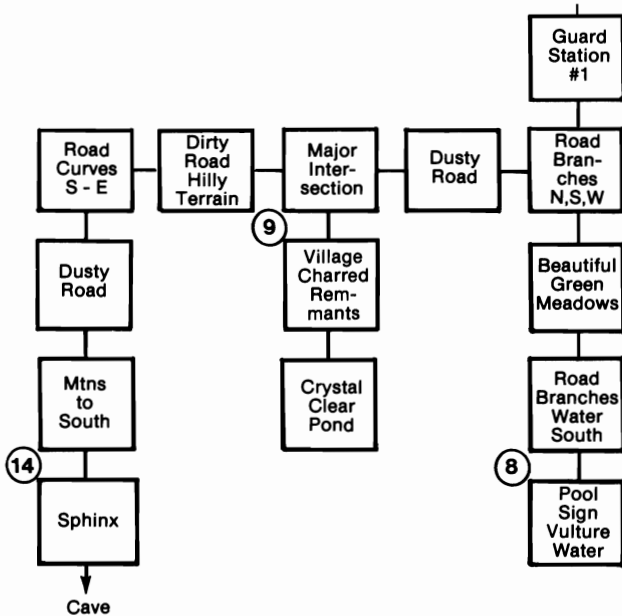

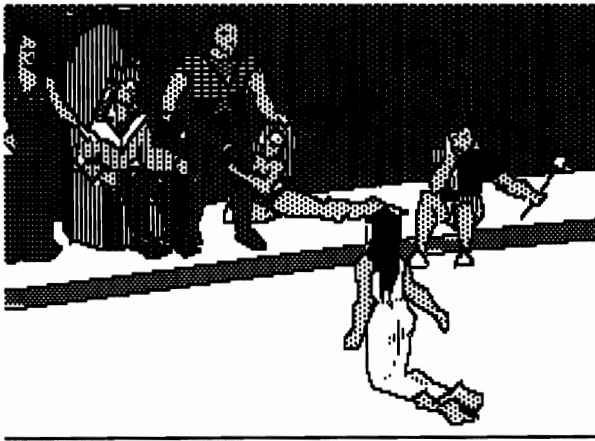

THE QUEST

Part 1

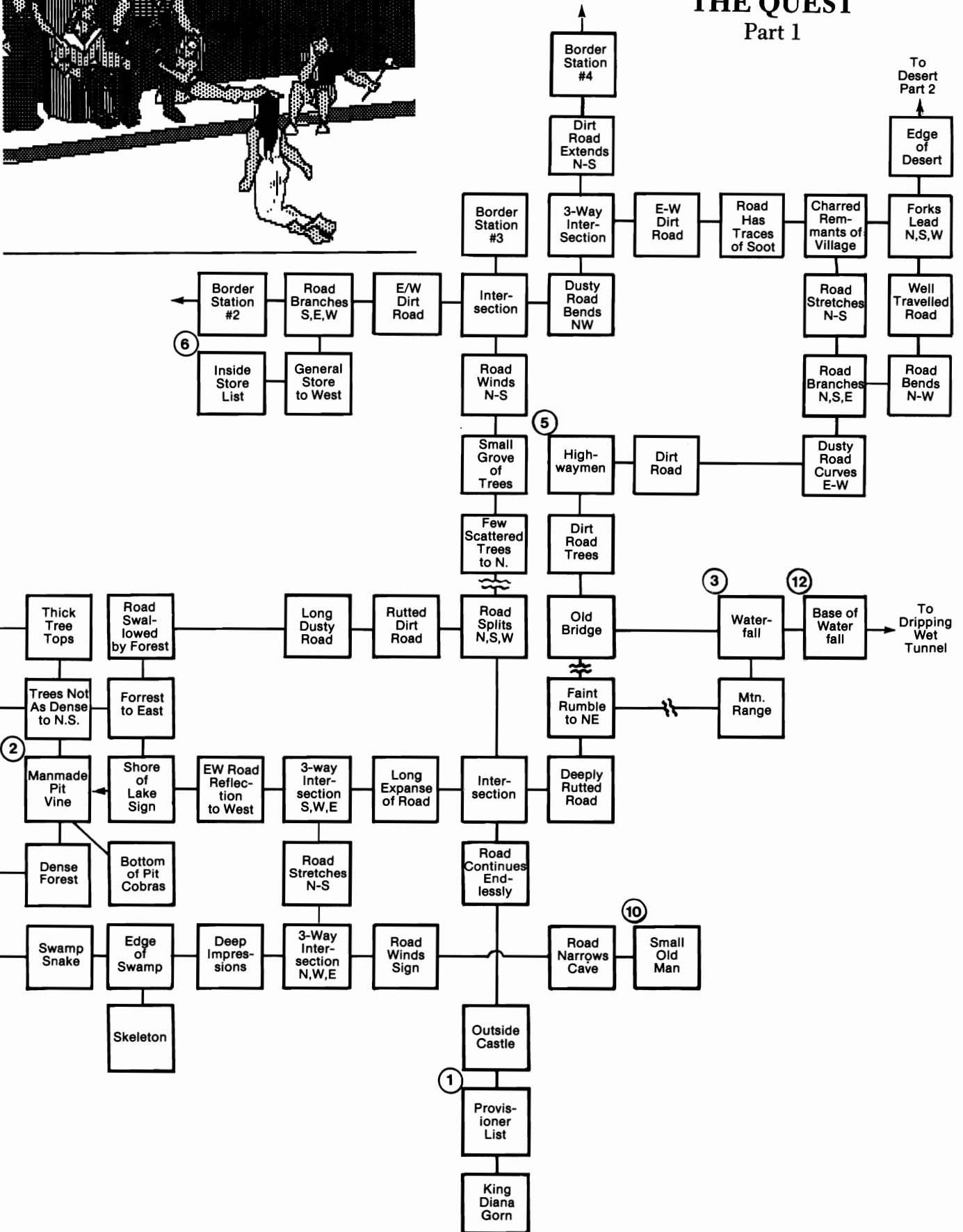

THE QUEST

Part 2

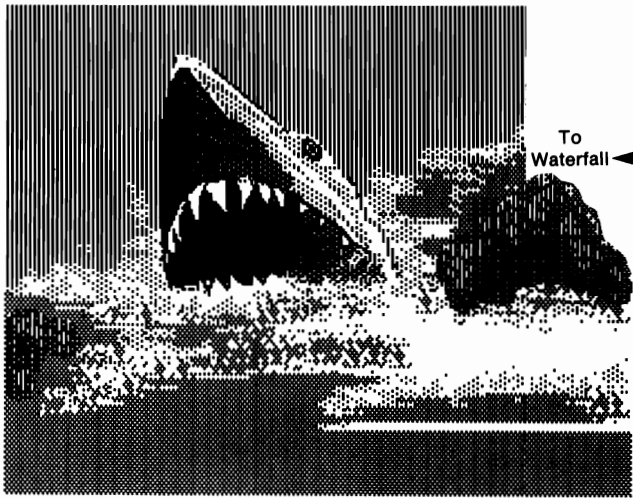
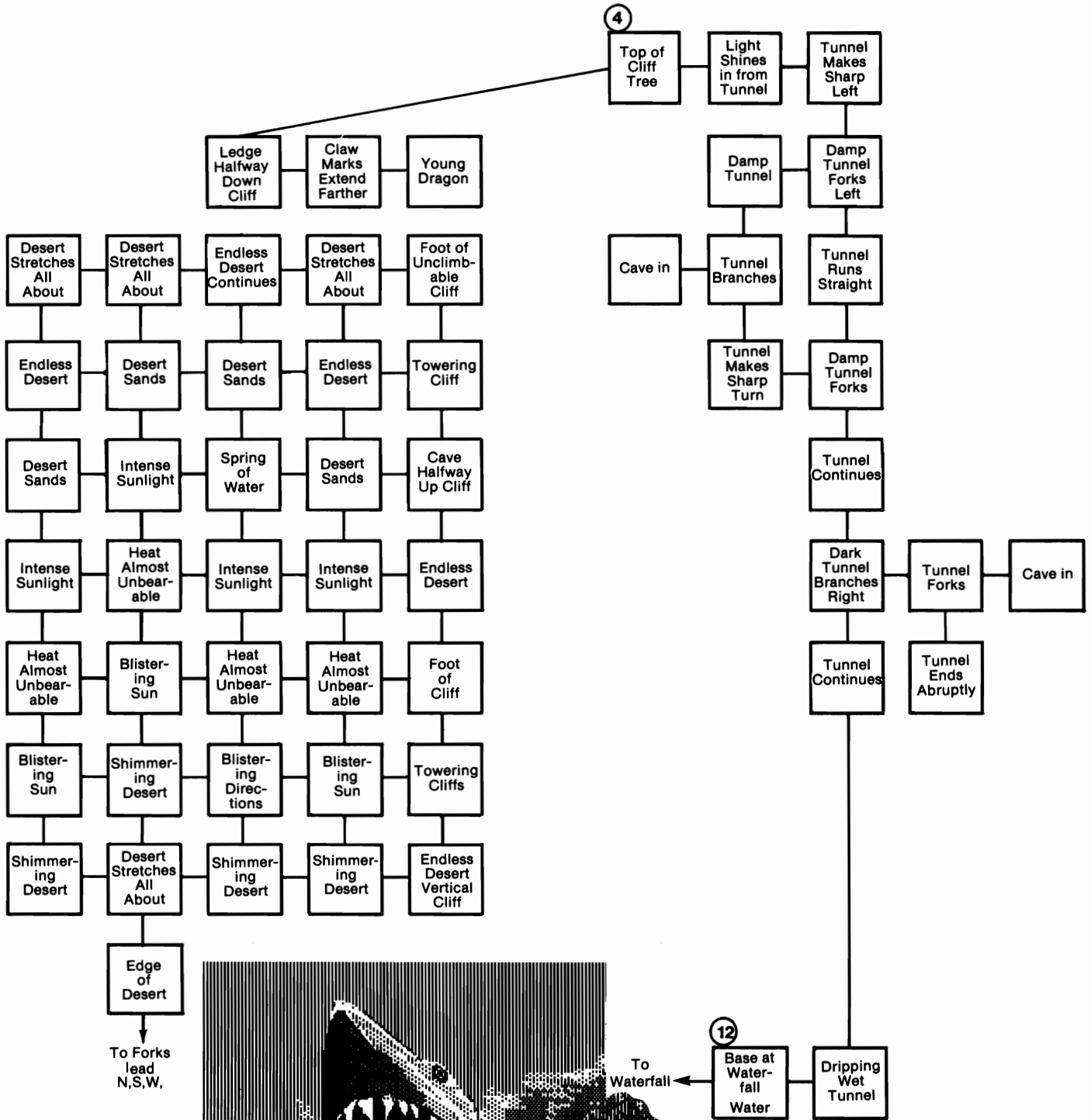

THE SANDS OF EGYPT

Company: Datamost

Suggested Retail: \$29.95

Type: A Hi-Res adventure with color graphics and animation.

Description:

You are a world famous archaeologist, now lost in the desert, near what you believe to be a hidden burial chamber. Thirst be damned! You have a reputation to uphold, so it's on to the hoped-for treasure.

Playability:

Some nicely animated graphics and fast color fill. For the most part, however, the graphics are just average. An amusing internal (H)elp message comes in handy. The puzzles aren't tough once you understand the sand maze, which is quite well done. You can make saved-game scenarios to the program disk and call them at any time. Kids may need help with the mapping.



SAVAGE ISLAND PART I

Company: Adventure International

Suggested Retail: \$39.95

Type: An all-text game, now being revised into a Hi-Res version. Price includes *Savage Island, Part II* and *Golden Voyage*.

Description:

You try in this game to obtain the password that permits you to enter *Savage Island, Part II*. To do so, you must survive a tropical hurricane and a sickly bear, find a mysterious looking pirate, cope with a Neanderthal Man, and push the right buttons.

Playability:

A toughie, meant for those who breezed through *Mystery Fun House* and casually solved *Ghost Town*. Unfortunately, the save game feature is (perhaps) disabled during the toughest sequence of this game, where your early demise is left in the hands of the computer's randomizer. If not already familiar with the Scott Adams' series, you should not start with this game. While some parts move easily and quickly, the difficulty lies in staying alive long enough to get to them. The two-word syntax has a limited but adequate vocabulary. The text is a bit more expansive than the others, but not by much. It has a single, easily made or recalled saved-game.

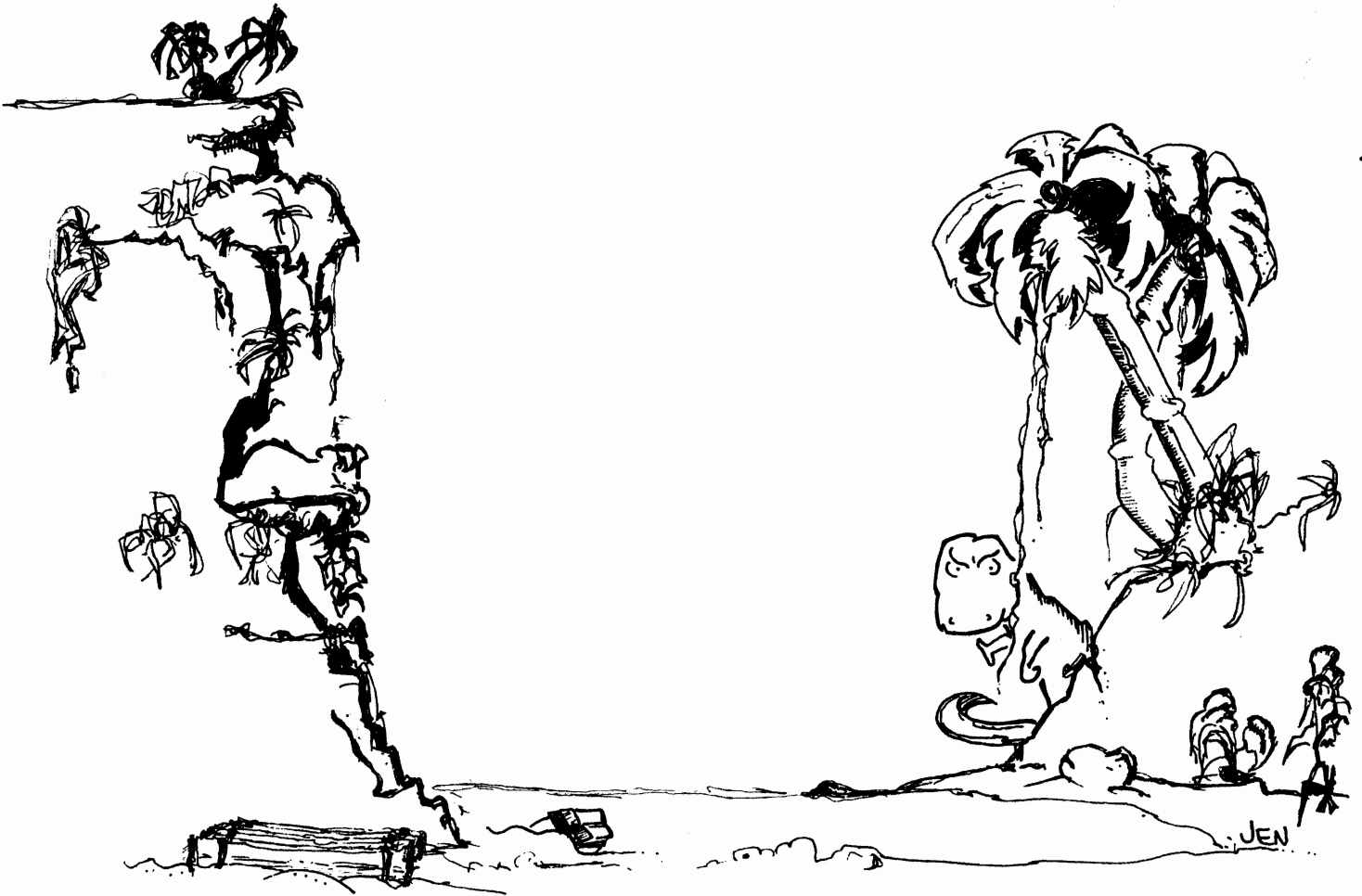

SAVAGE ISLAND PART II

Company: Adventure International

Suggested Retail: \$39.95

Type: An all-text game, soon to be revised into Hi-Res form. Price includes *Savage Island, Part I* and *Golden Voyage*.

Description:

A toughie, full of a curious mix of prehistoric and space age entanglements. If you can get through the game, you get the code needed to decipher the secret message sheet that came with the game. Except for a few characters, the two *Savage Islands* have little in common and do not resemble each other. In the process of trying to solve this jewel you will encounter vacuums, force fields, atomic blocks, four consoles with levers, dials and buttons, and your old friends, the Neanderthal Man and the Pirate.

Playability:

This game starts out with a bang, so to speak, and that bang is most likely you! The game lives up to the first sign that you see, which says "Part I was a piece of cake compared to what you are about to go through." It does ease up a bit after the first move puzzle. The two-word syntax has a limited but adequate vocabulary. The text is brief and to the point. The game permits a single easily made or recalled saved-game.

SAVAGE ISLAND Part II

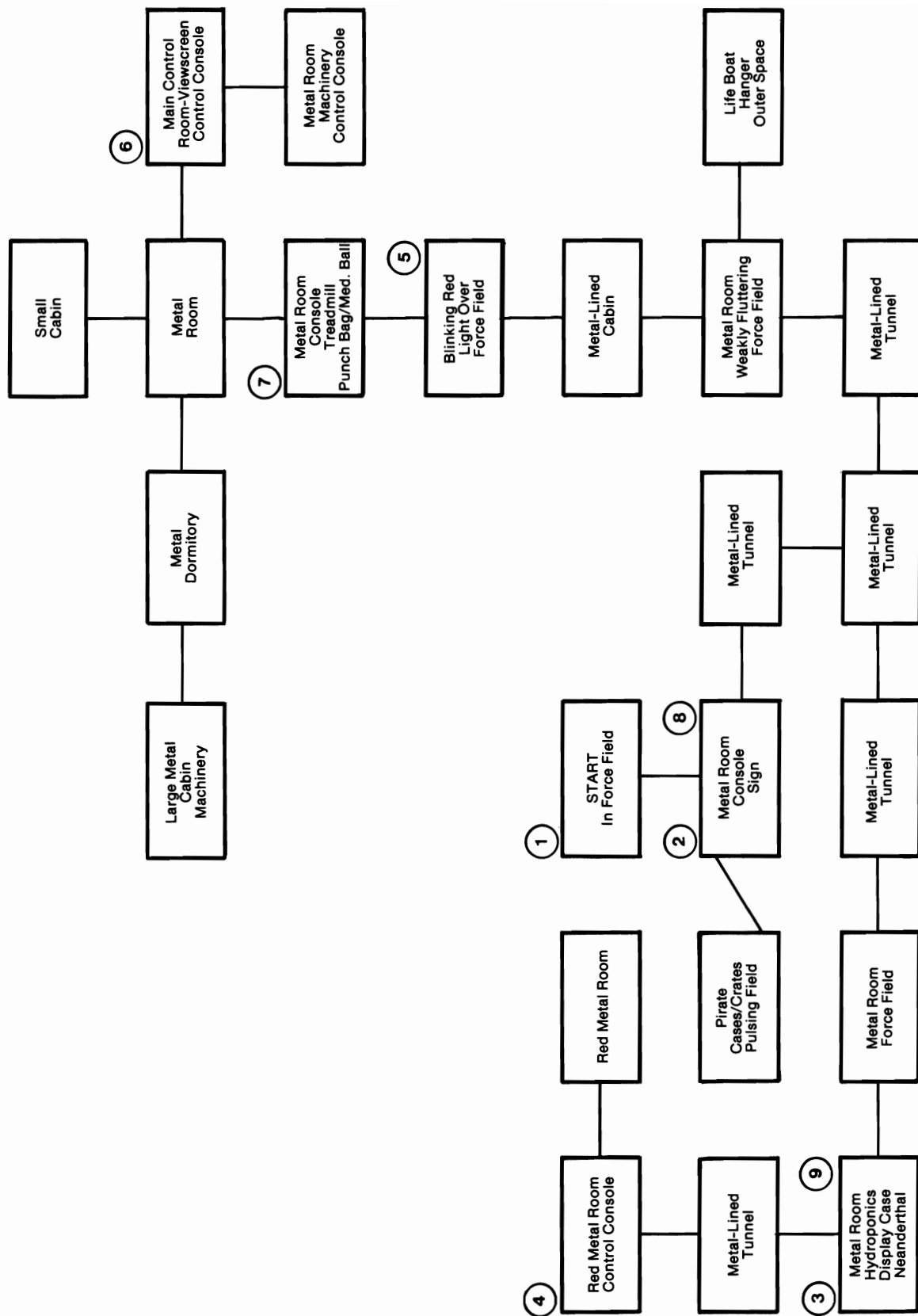

SECRET AGENT: MISSION ONE

Company: Jor-And

Suggested Retail: \$32.95

Type: Black and white Hi-Res adventure, the first in a series.

Description:

Your mission: to locate and deactivate a near-ultimate weapon and escape before the waiting bombers pound the island (and you) into dust. Many puzzles crop up between the beginning, where you're in an airplane about to get shot down, and the end, where you reach the waiting helicopter and safety. The game includes a difficult maze and many straightforward puzzles.

Playability:

The graphics are neat and crisp, but the text, somewhat sparse. Although the plot won't win any awards, it does hold your interest throughout the game, presenting several interesting twists along the way. The two-word syntax and limited vocabulary are unusually well-integrated into the game's design. You get a single save-game position, written to or recalled from the disk any time the command cursor is available.

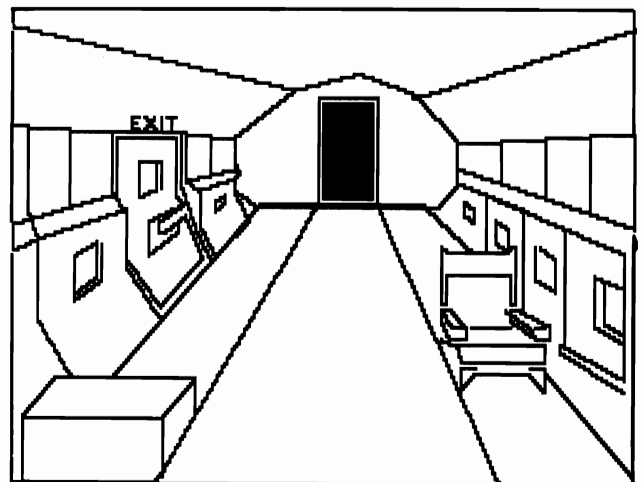
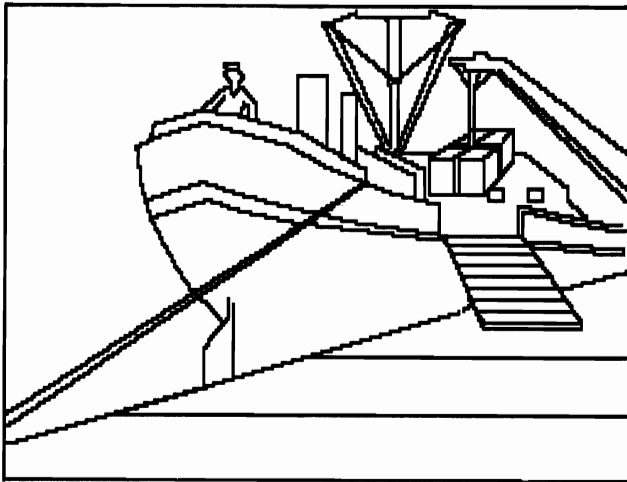

SECRET AGENT: MISSION ONE

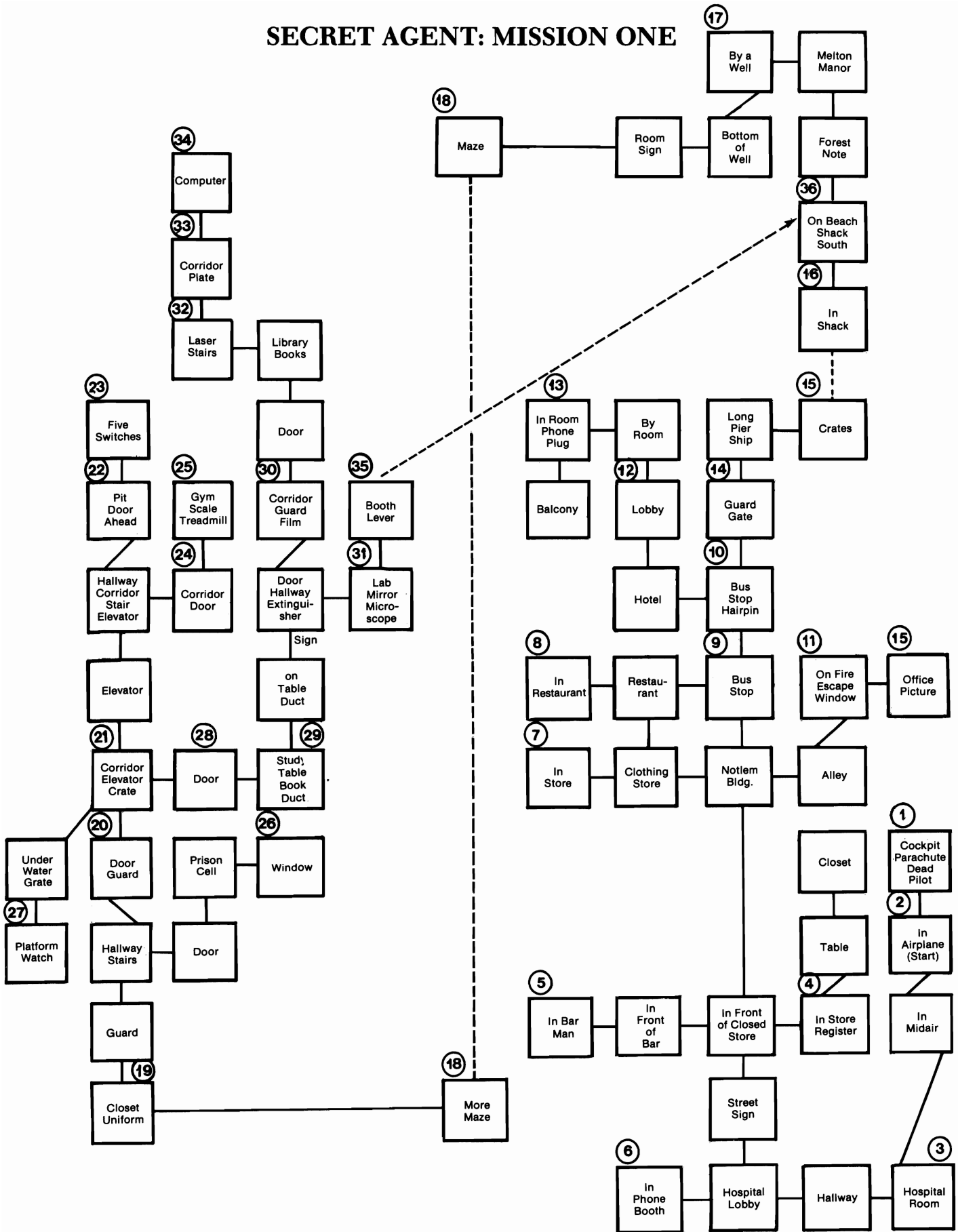

SERPENT'S STAR

Company: Ultrasoft

Suggested Retail: \$39.95

Type: An animated Hi-Res adventure with color graphics and Hi-Res text.

Description:

The setting: Tibet. Your mission: find the last three scrolls which lead to the fabled Serpent's Star gem and steal it. To accomplish this dastardly deed, you must visit two monasteries, buy and give away objects, initiate a few quick actions, dodge through an avalanche, answer five riddles, navigate the maze, and even solve a puzzle or two.

Playability:

Three of the five riddles are a basic test of Buddhist and Yogi tenets, and you only get one chance to answer each question correctly. You get no clues to the tougher puzzles. *Serpent's Star* is a game that many have started but few have completed (before giving up in frustration). This book should help a lot!

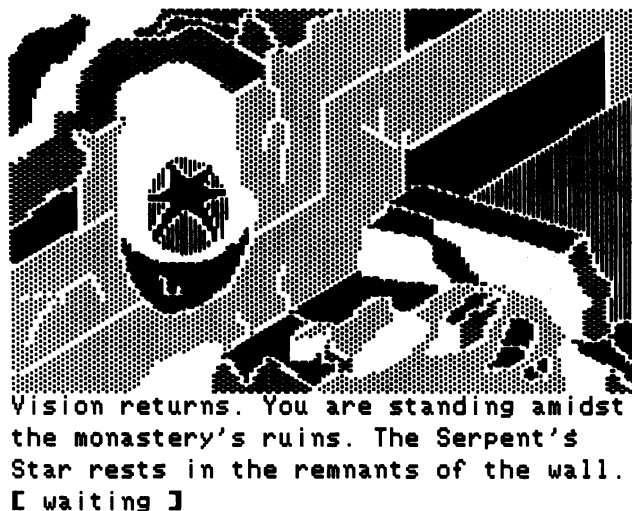

SERPENT'S STAR

Part I

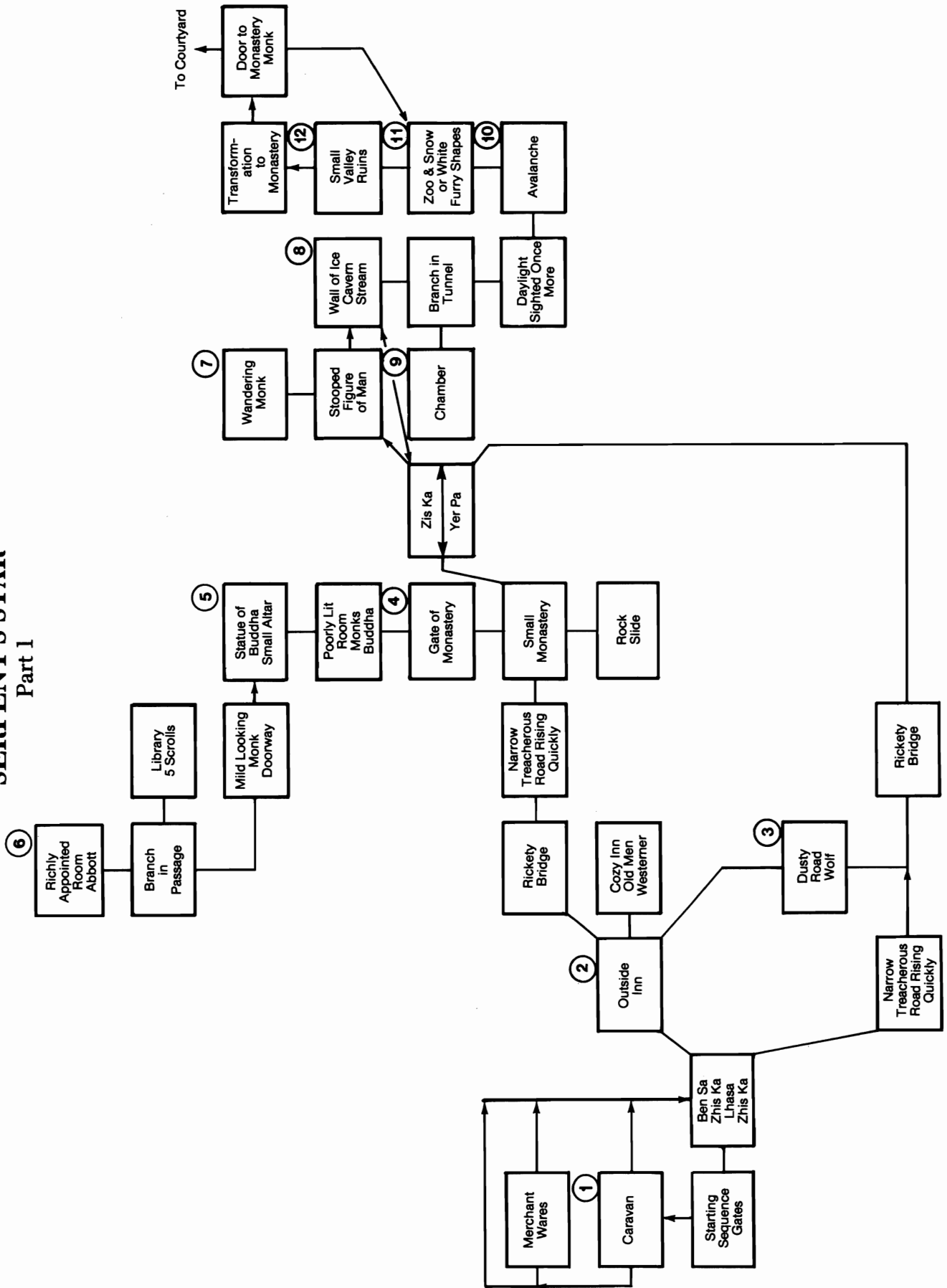

SHERWOOD FOREST

Company: Phoenix Software

Suggested Retail: \$34.95

Type: Hi-Res adventure with color graphics and animation.

Description:

As Robin Hood, it's your wedding day. But several puzzles lie between the wedding and your shooting off to the Honeymoon Suite with the fair Maid Marion. You have lost your pretty green uniform, and your old friends don't recognize you. Find that, get something to amuse your merry men, and you'll be on your way. A bit of animation adds a nice touch.

Playability:

Extremely well implemented. Aimed at the beginning to intermediate adventurer, it moves quickly. Not too tough, but cleverly interactive puzzles have several amusing twists. The command parser supports more than two words, and the save-game feature is excellent. A very light-hearted and cheery game. Great for kids.



SHERWOOD FOREST

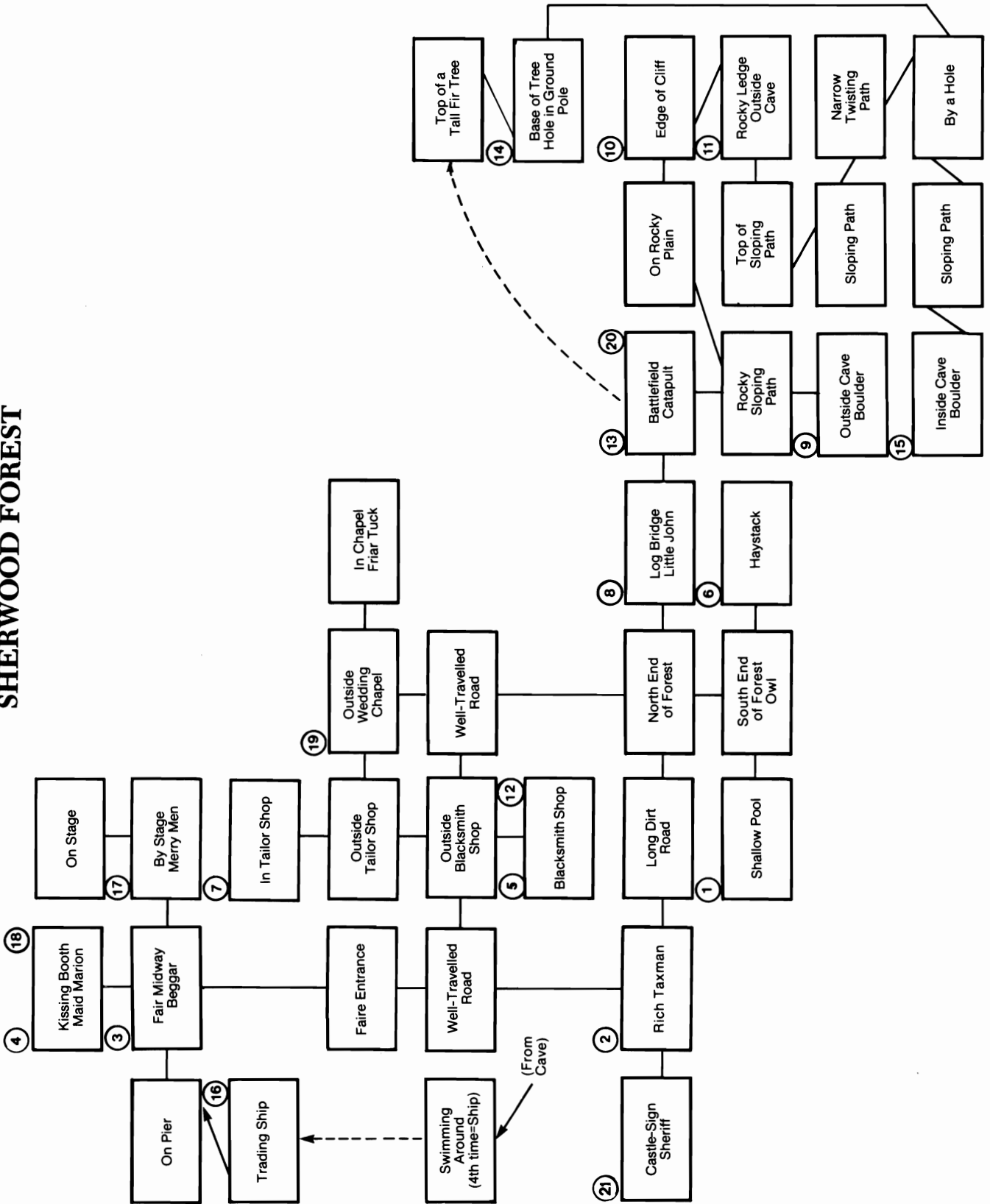

SOFTPORN ADVENTURE

Company: On-Line Systems

Suggested Retail: \$29.95

Type: An all-text adventure.

Description:

Your goal, bizarrely enough, is to find and seduce three women. The game also incorporates both blackjack and slot machine games—these broads are expensive! Descriptions are PG rated, while user input can be X-rated.

Playability:

A moderately difficult but quite challenging and solvable puzzle game good for would-be adventurers. You can save the game on a scratch disk, but you can't recall it from within the game. Lots of tongue-in-cheek humor.

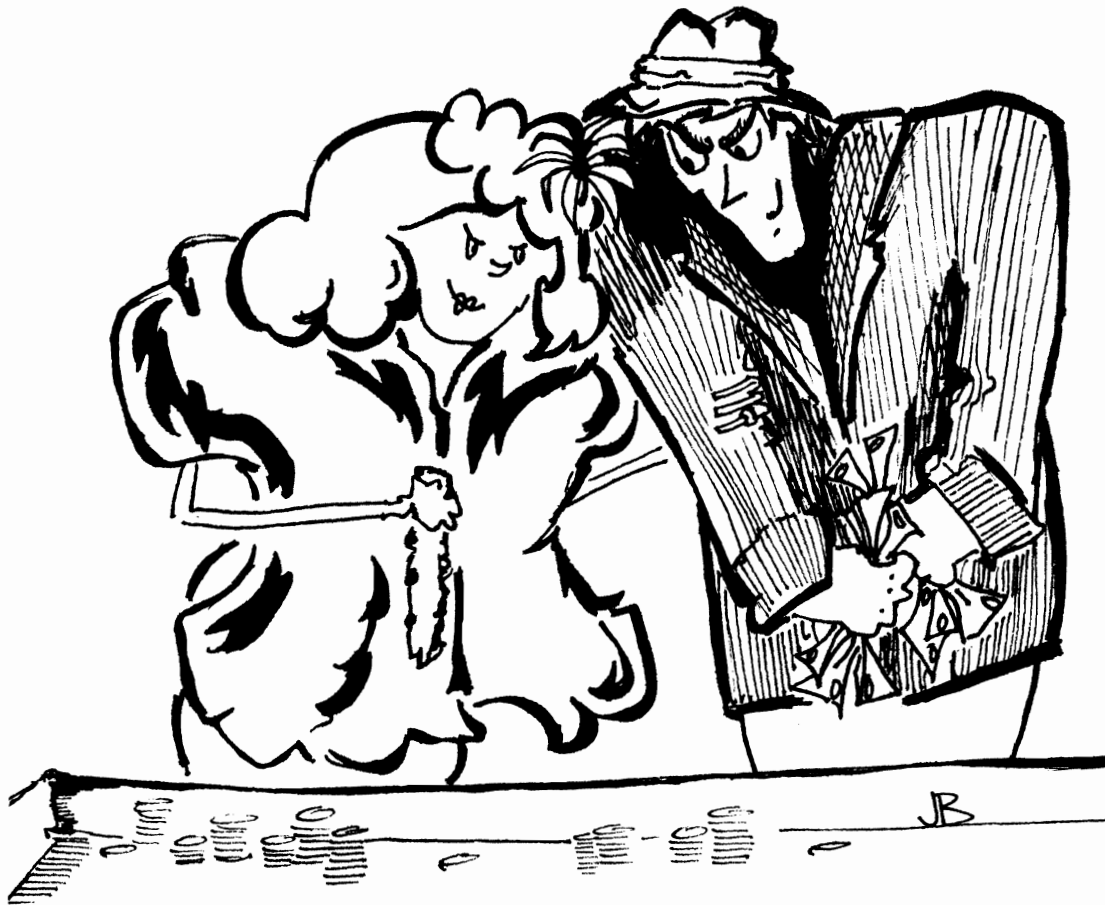

SOFT-PORN ADVENTURE

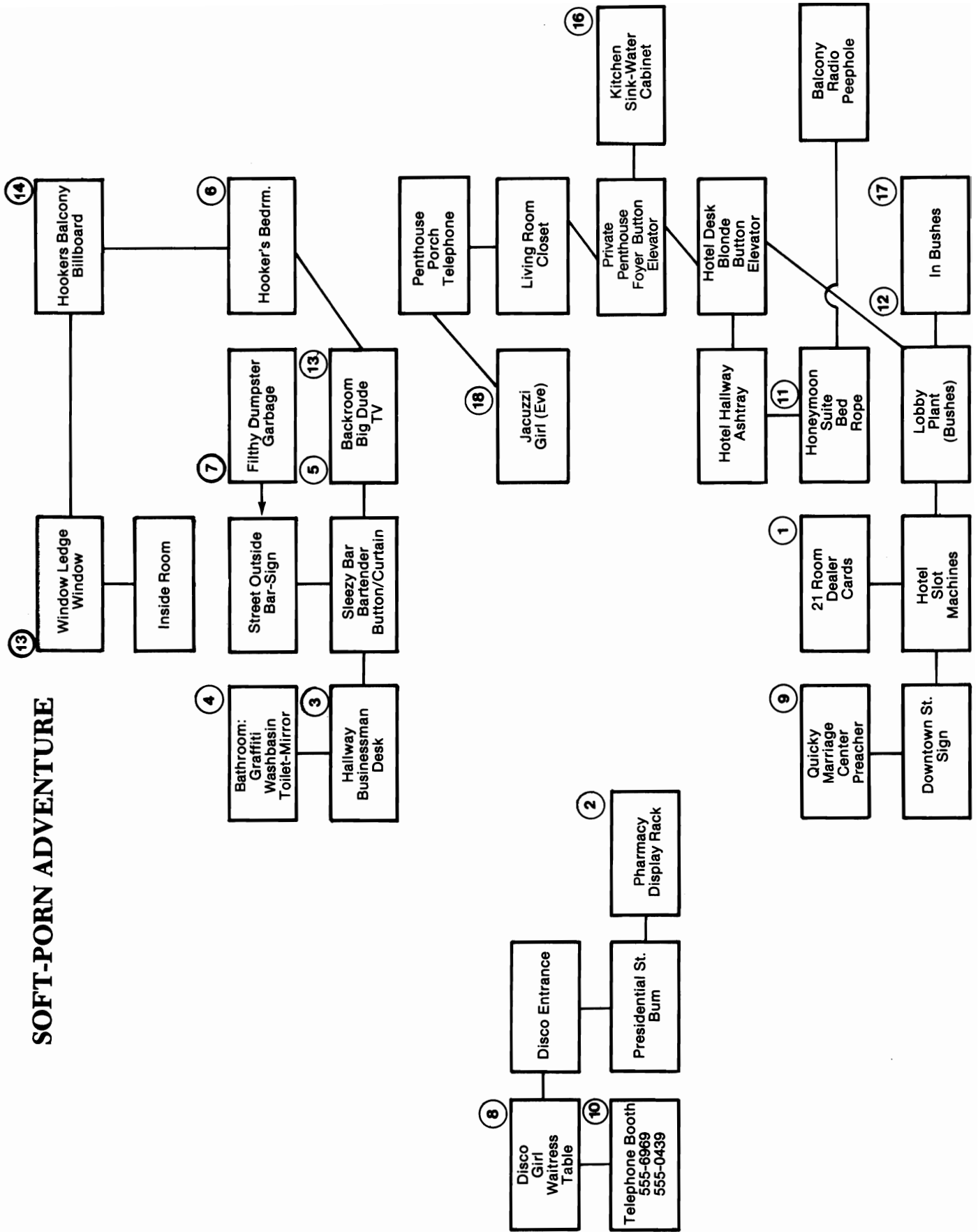

SORCERER

Company: Infocom, Inc.

Suggested Retail: \$49.95

Type: An all-text adventure, a follow-up to *The Enchanter*.

Description:

Remember taking the role of neophyte wizard in *The Enchanter*? Well, you're back again, this time armed with seven spells at the outset. Seems that your mentor, the aged and wise Belboz, has gone off on a secret mission to rid the world of an evil force so sinister that he dare not reveal it to any in the Circle of Enchanters. You must find and rescue him, which you can accomplish only by doing in the evil force known as Jearr. You'd better find the nine other spell scrolls or you won't have a chance.

Playability:

A worthy successor, with the promise of a third. Interactive puzzles and reasonably jazzy text, though not as golden or expansive as some others from Infocom. The parser and save-game capability don't get any better—they can't. The difficulty factor is well chosen, not too tough for a novice (with lots of patience) and plenty challenging for the experienced dungeon trekker.



SORCERER

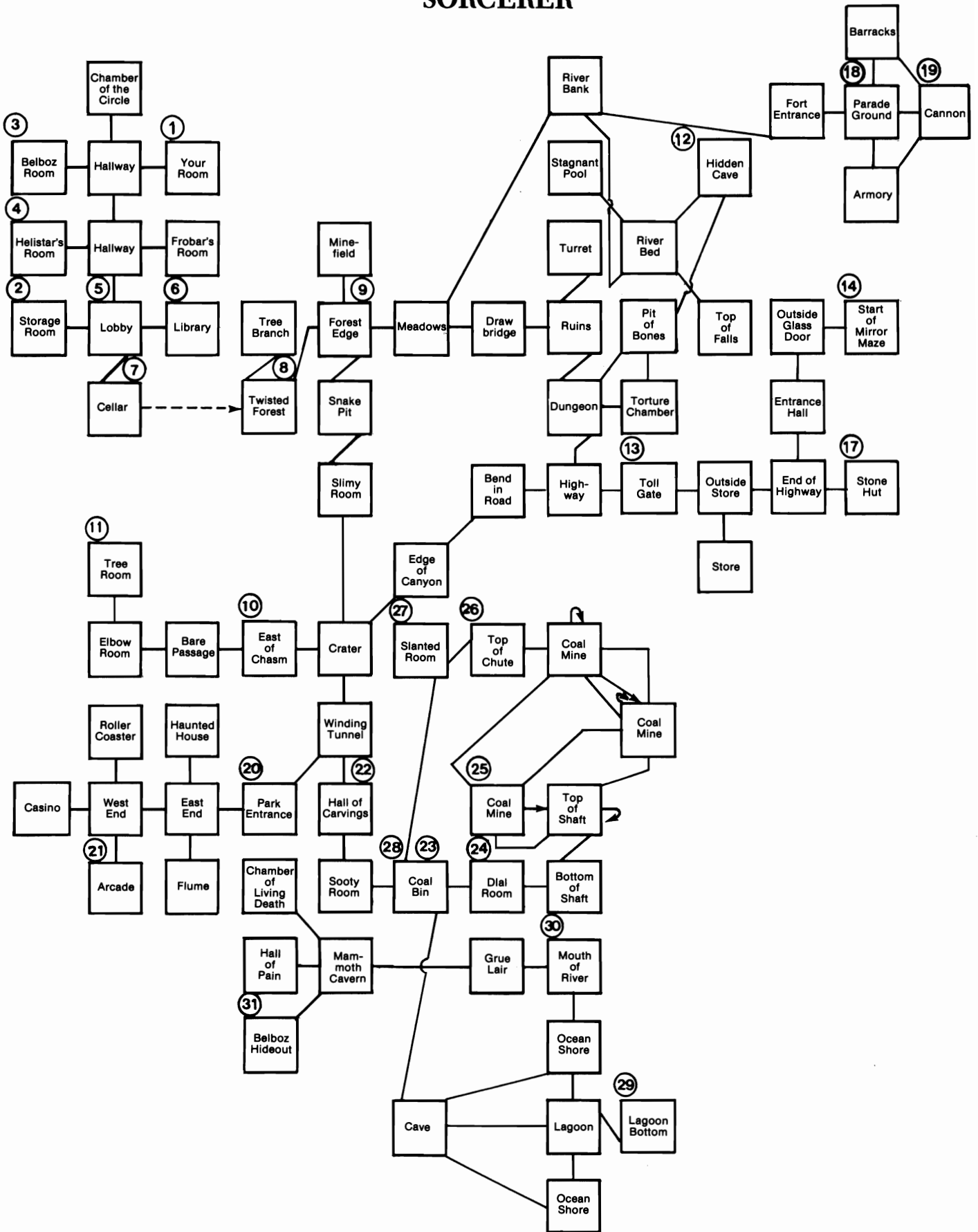

SORCERER MAZES

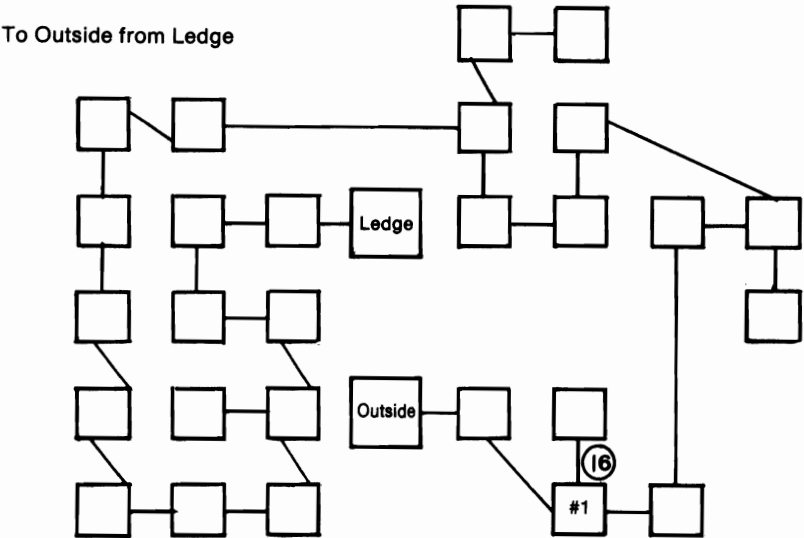
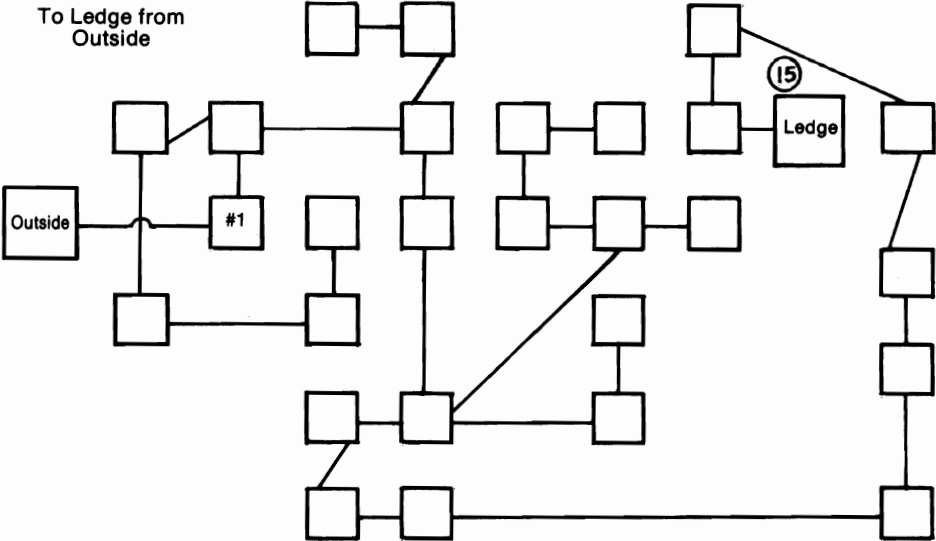

STARCROSS

Company: Infocom, Inc.

Suggested Retail: \$39.95

Type: An all-text science fiction adventure.

Description:

It's long ago and far away when suddenly the strident alarm of your one-man spaceship awakens you, advising you of the presence of an uncharted mass in space. Naturally curious (if not, it would make a very short game), you rendezvous, effect an entrance, turn on some lights and encounter both living and dead remnants of preceding alien civilizations, advanced technology, religious superstition, and past tragedy. Hopefully, you will be accorded the salutation of Galactic Overlord.

Playability:

While less difficult than its predecessors in the series, the game contains a relatively hard sequence which involves obtaining one of the twelve differently colored control rods. Throughout, the true use of the Ray Gun, required to successfully complete the game, is neatly disguised. It's almost a shame to waste the story line on kids who will simply enjoy the puzzles and ask a lot of embarrassing questions about the Periodic Tables, Newton's Third Law, and Solar System basics.

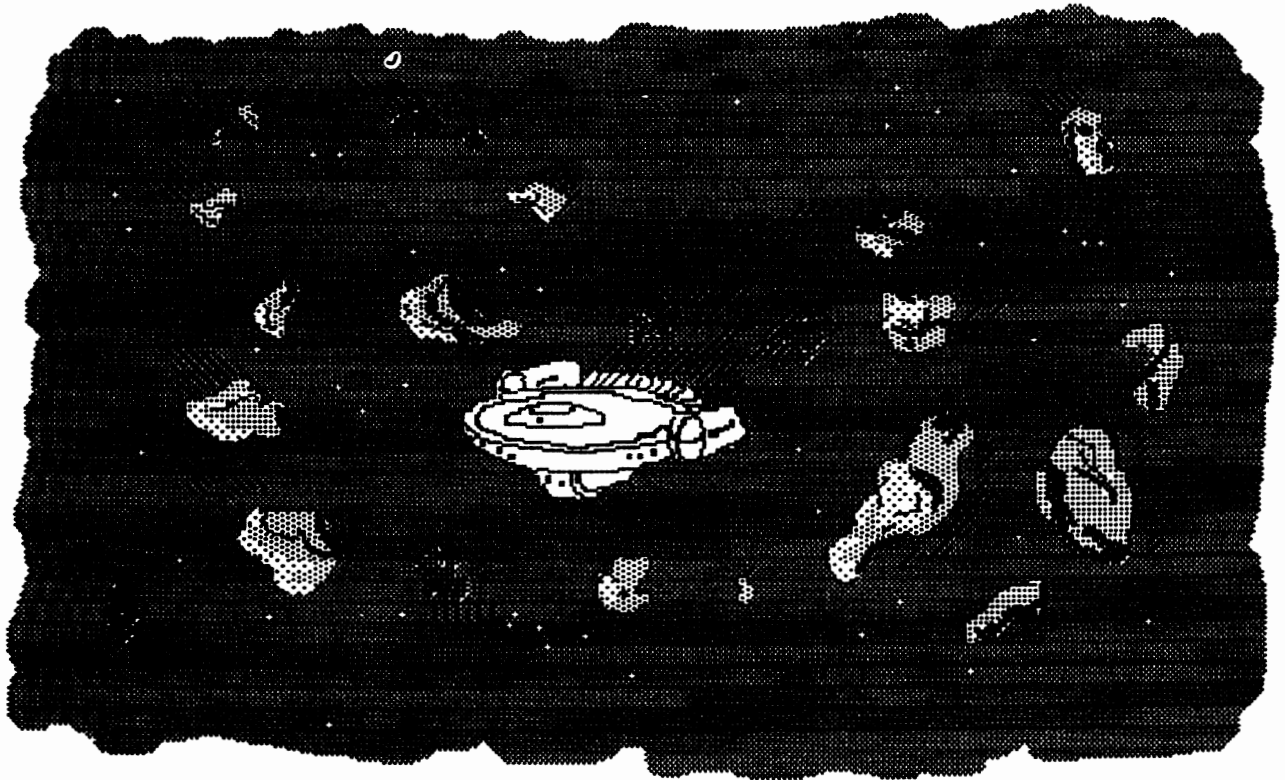

STARCROSS

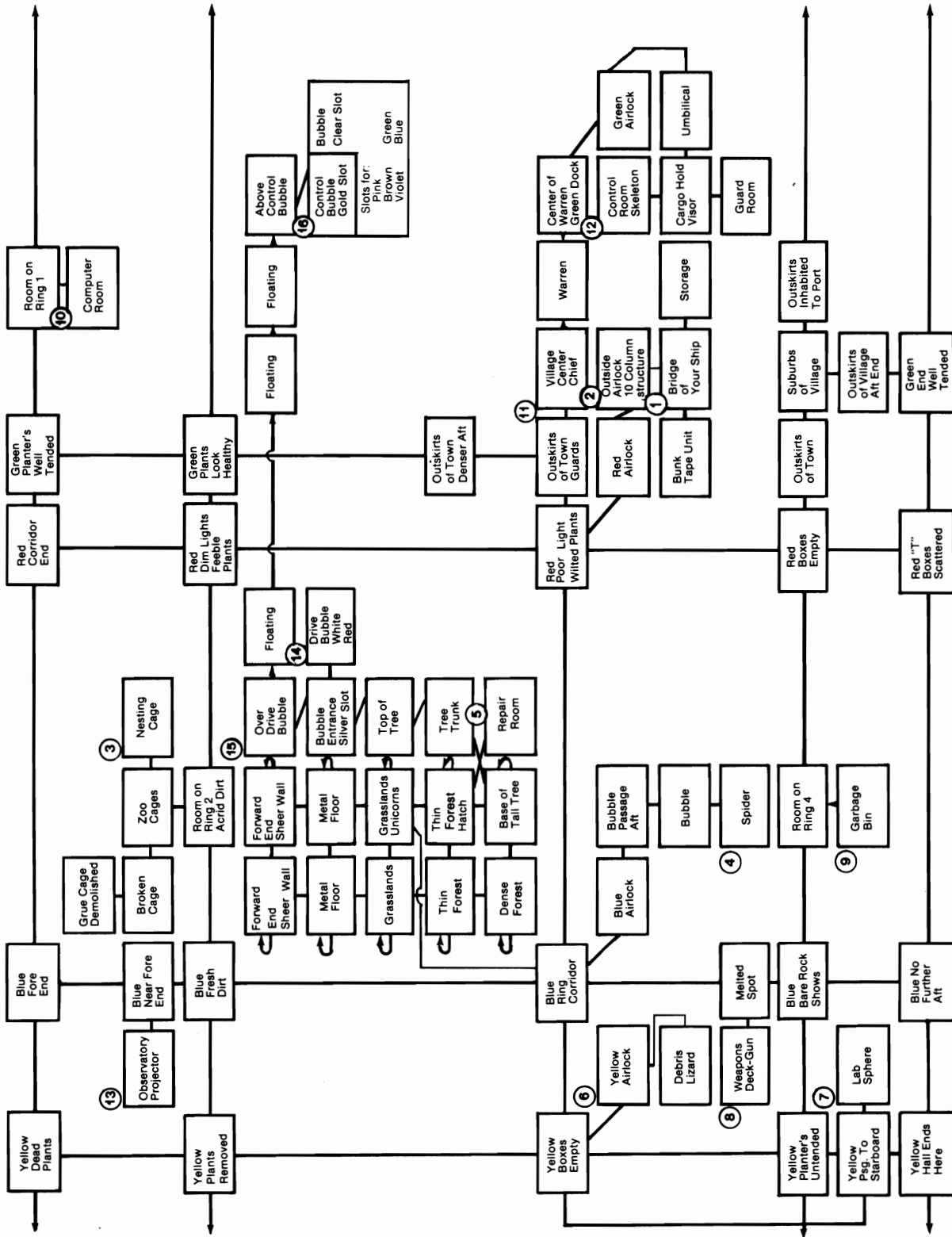

STRANGE ODYSSEY

Company: Adventure International

Suggested Retail: \$39.95

Type: An all-text game, scheduled for revision into Hi-Res form. This price also includes *Voodoo Castle* and *The Count*.

Description:

Stranded on an alien planet in a damaged spaceship, your only hope lies in finding objects needed to repair your ship, figuring out how to do it, obtaining the planet's five treasures, and returning home. You cannot simply take all of the treasures—diamonds, especially, are tough to obtain.

Playability:

The puzzles are not too hard once you figure out how to get around among the locations of this game. Four of the five treasures you want you can get into the fold without too much trouble, but getting the fifth becomes a dog of a job and it might take a pretty cold day before you pry it loose. The two-word syntax has a limited but adequate vocabulary. The text is brief and to the point. The game offers a single easily made or recalled saved-game.

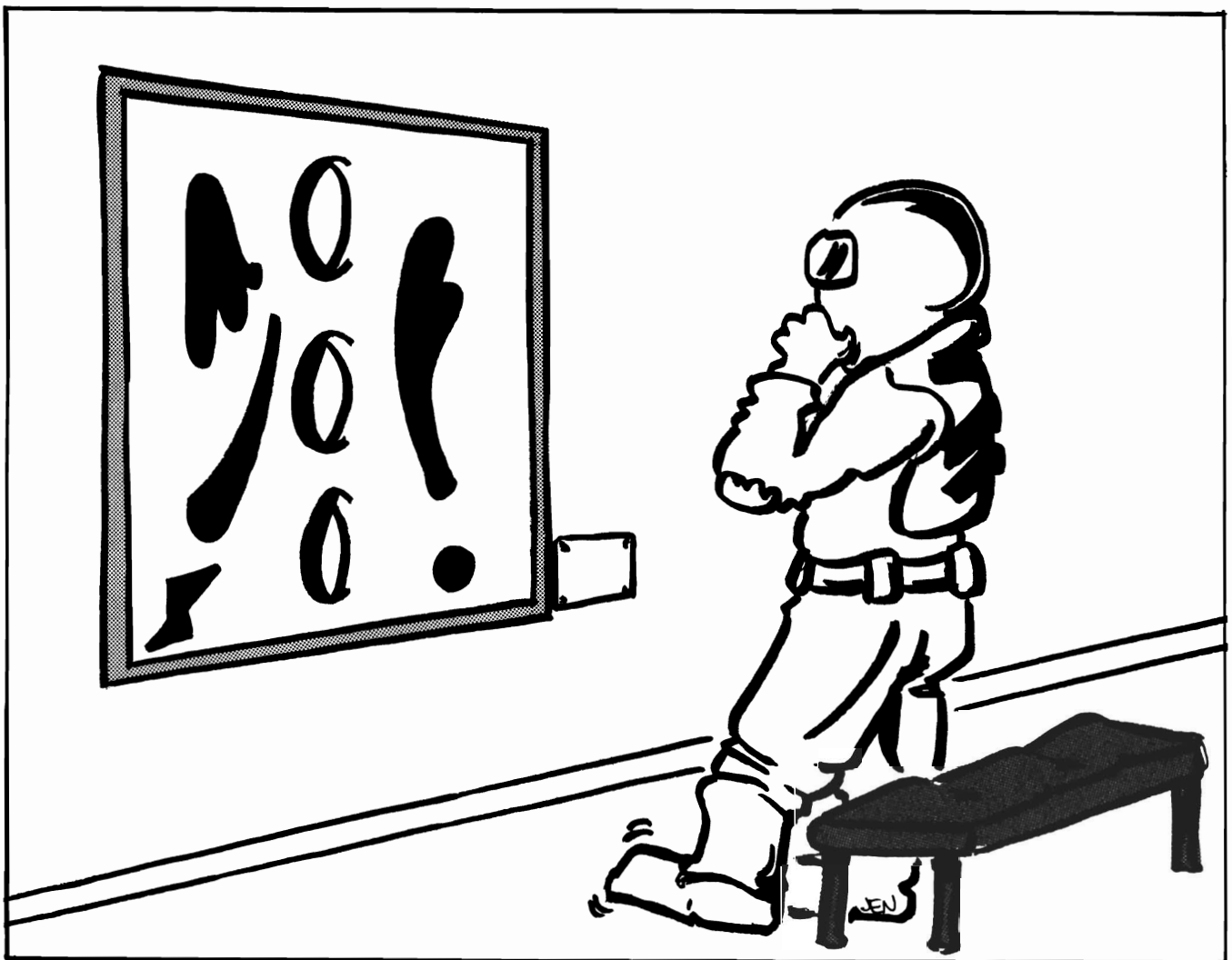

STRANGE ODYSSEY

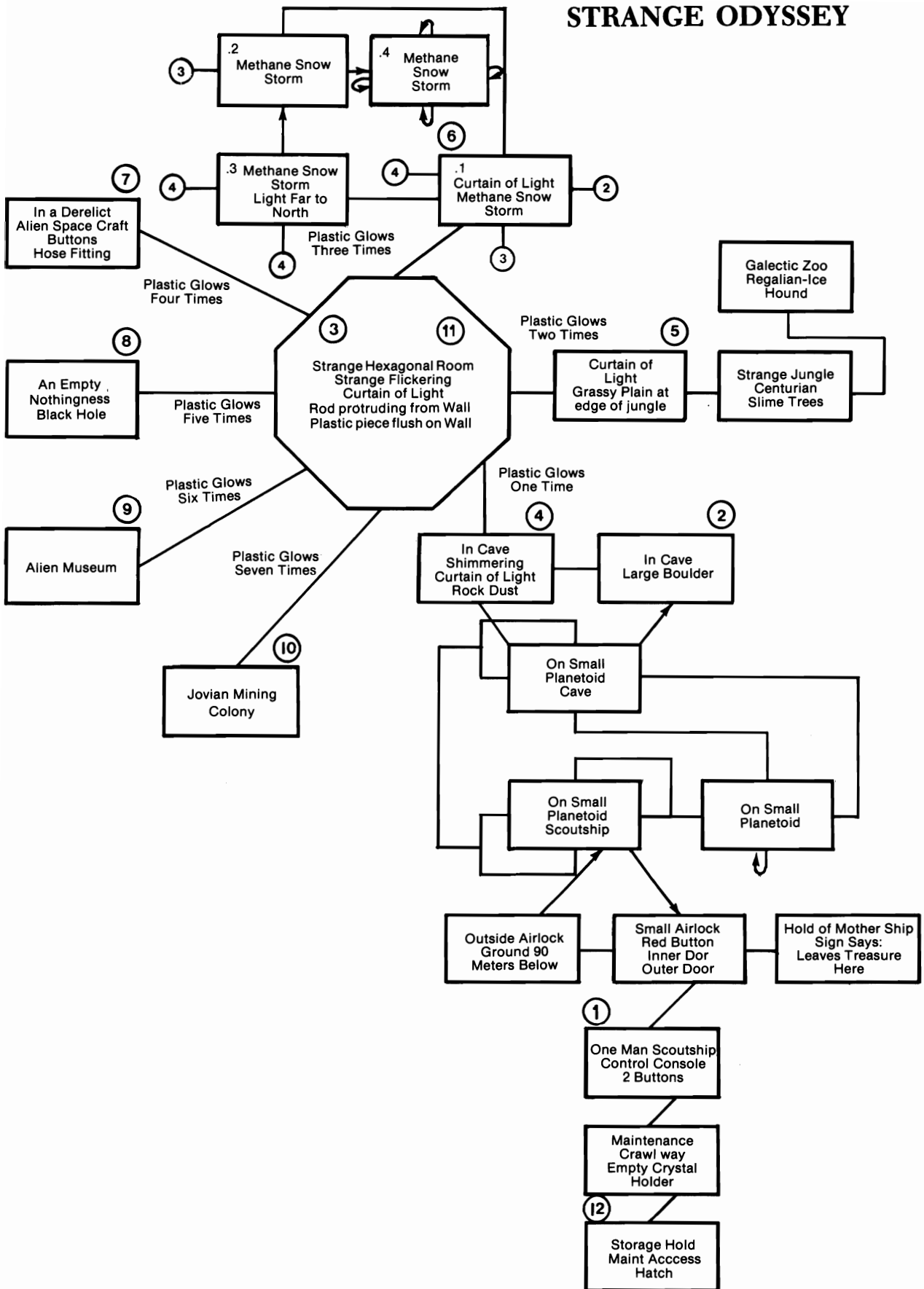

SUSPENDED

Company: Infocom, Inc.

Suggested Retail: \$49.95

Type: A science fiction all-text adventure.

Description:

It starts as just another day in the life of the central mentality of a planet—that's you. Normally, three underground computers maintain stability and equilibrium in the weather, food growing and transportation systems, but today just isn't one of your better days. Seems like everything's going wrong, so you must use your wits, manual override capabilities, and six independently controlled robots to right the wrongs. The robots will steal the show, each with his own unique capabilities.

Playability:

The puzzles are complex and very interactive, but few in number. Depending on how well you manage to repair things while minimizing the loss of life on the planet's surface, the ending will grade you with interesting witticisms, or, if you flunk out, "talking mechanisms" will summarily replace you. As always, the Infocom parser, vocabulary, and save-game capability appear in fine form.

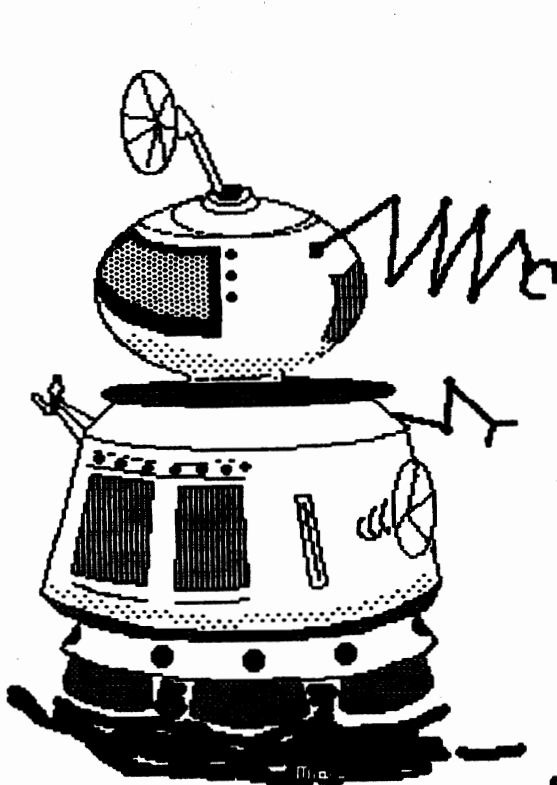

Sensa

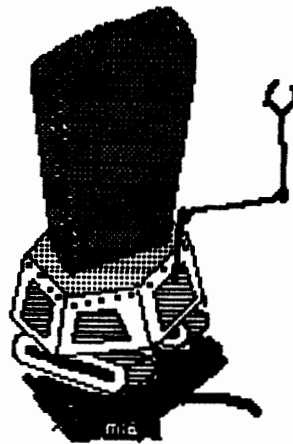

Auda

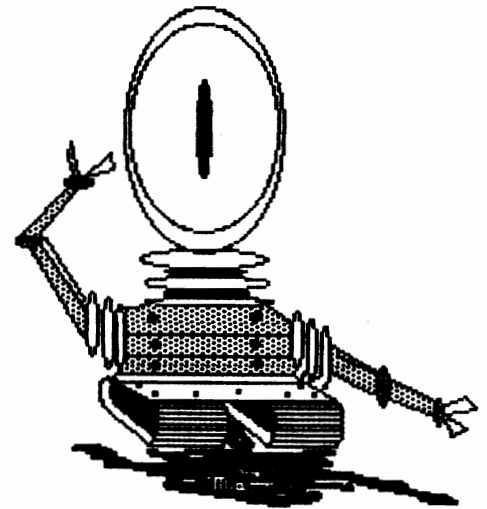

Iris

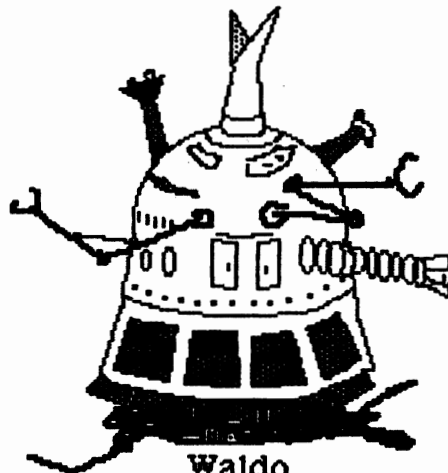

Waldo

SUSPENDED

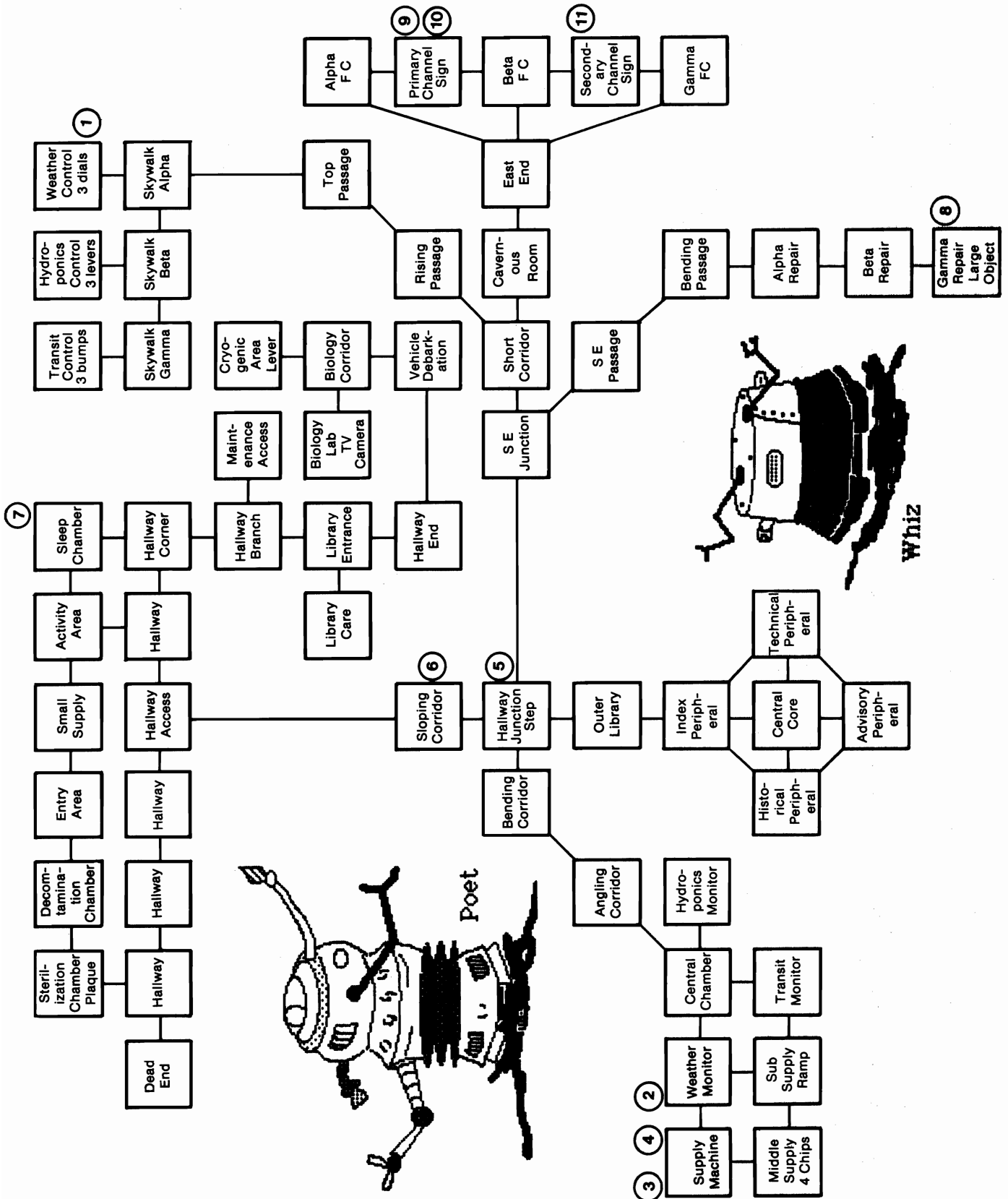

TIME ZONE

Company: Sierra On-Line Systems

Suggested Retail: \$99.95

Type: A monster-sized Hi-Res adventure with color graphics.

Description:

In the course of your mission you use the Time Machine in your backyard to travel into the future to Neburon, deal appropriately with the evil Ramadu, and destroy his Ray Gun before it demolishes the Earth. You also need to return home safely to garner the title of Ultimate Adventurer. To achieve this rank requires traveling through twenty-four of thirty-nine accessible eras. Beware, this game is of humongous proportions, considering its six double-sided disks. The scope and size warrant the price.

Playability:

Time Zone is a map maker's delight. The final product will fill a book! You encounter bunches of puzzles, but the majority prove more frustrating than tricky or difficult. Sorry, no help or hint option for this one. The command syntax allows two words only. Many ways of getting killed crop up, especially in areas useless to the solution! Be sure to save the game on entering each new land.

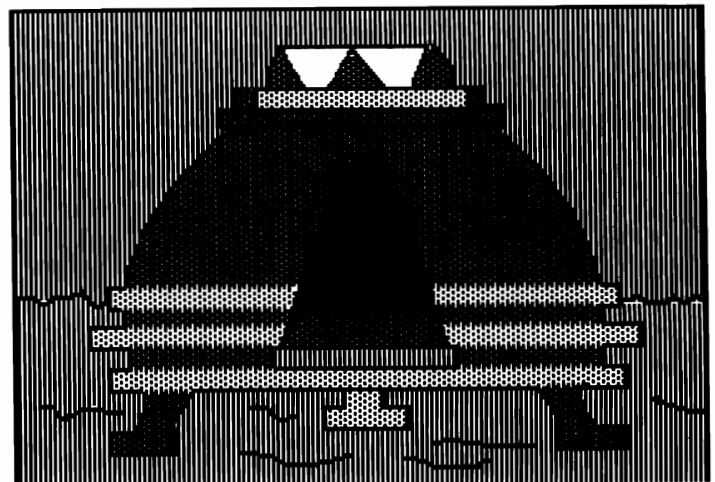
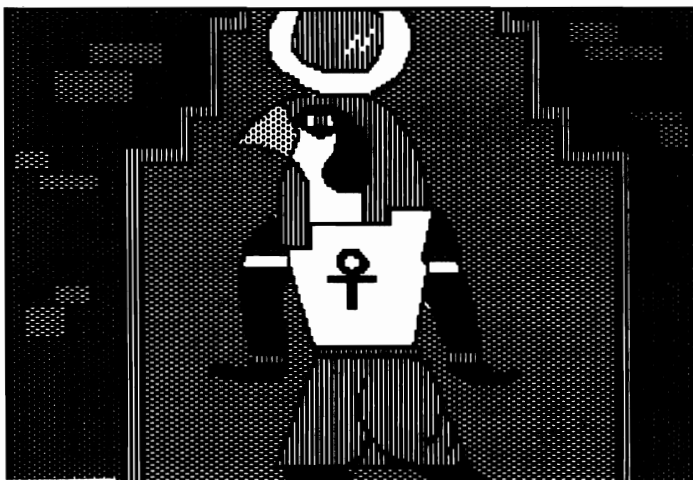
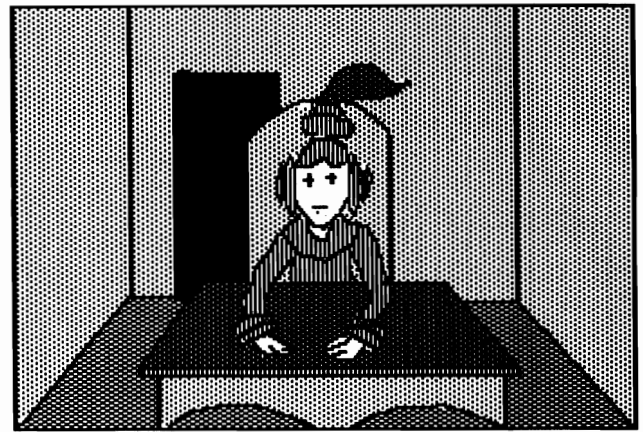
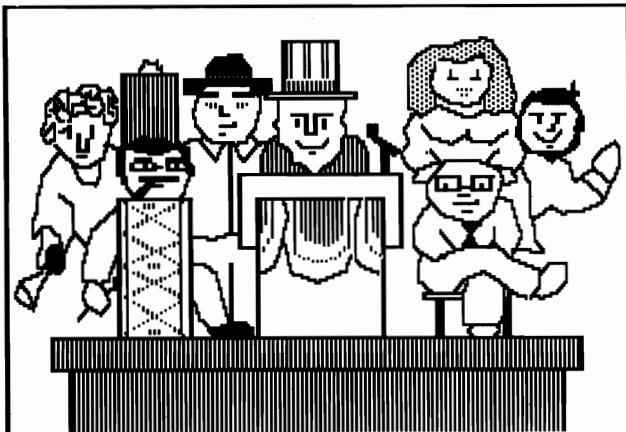

TIME ZONE
Europe 400 MBC

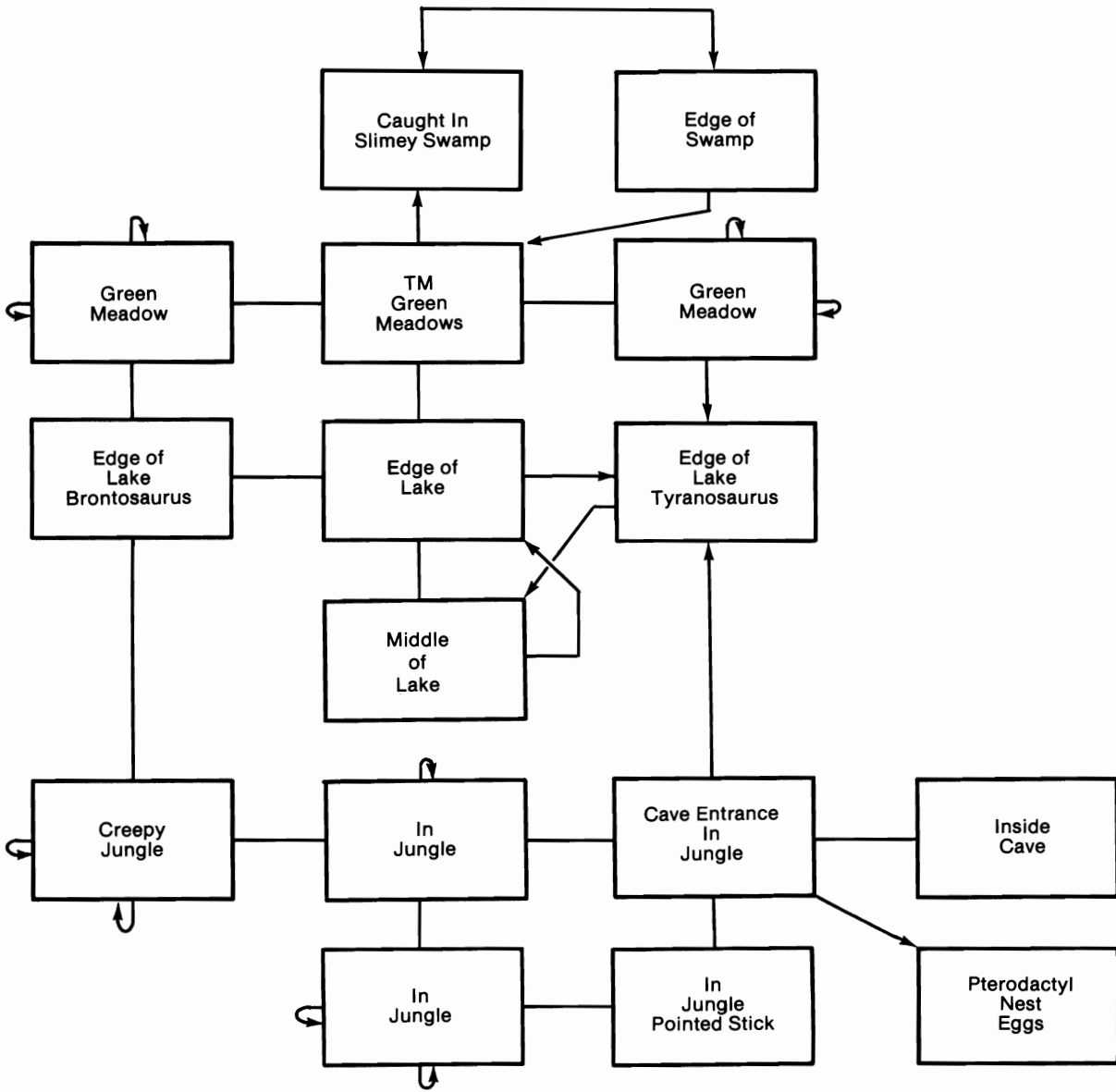

TIME ZONE
So. America/Inca City
1000 AD

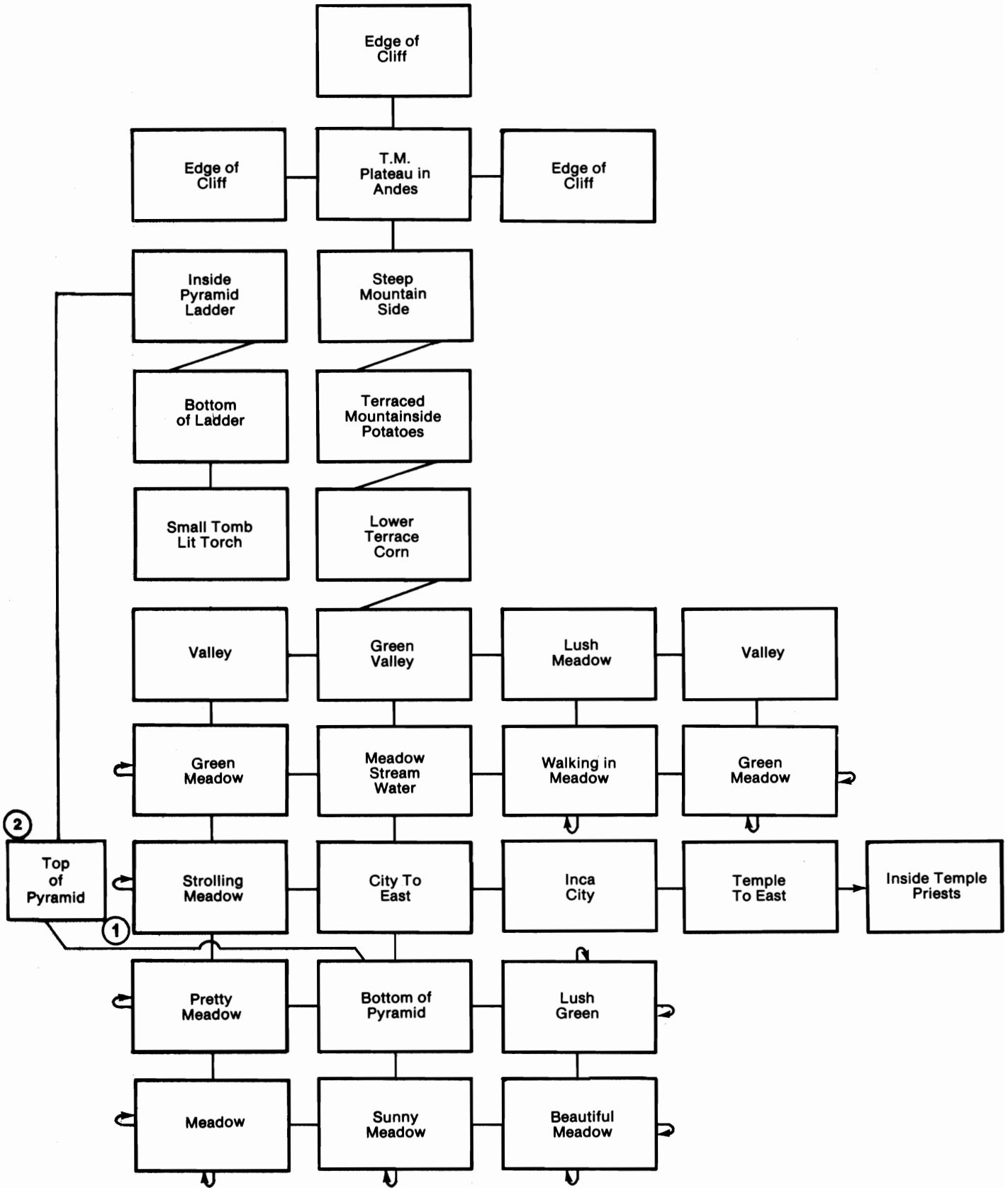

TIME ZONE
P/O Paris 1700 AD

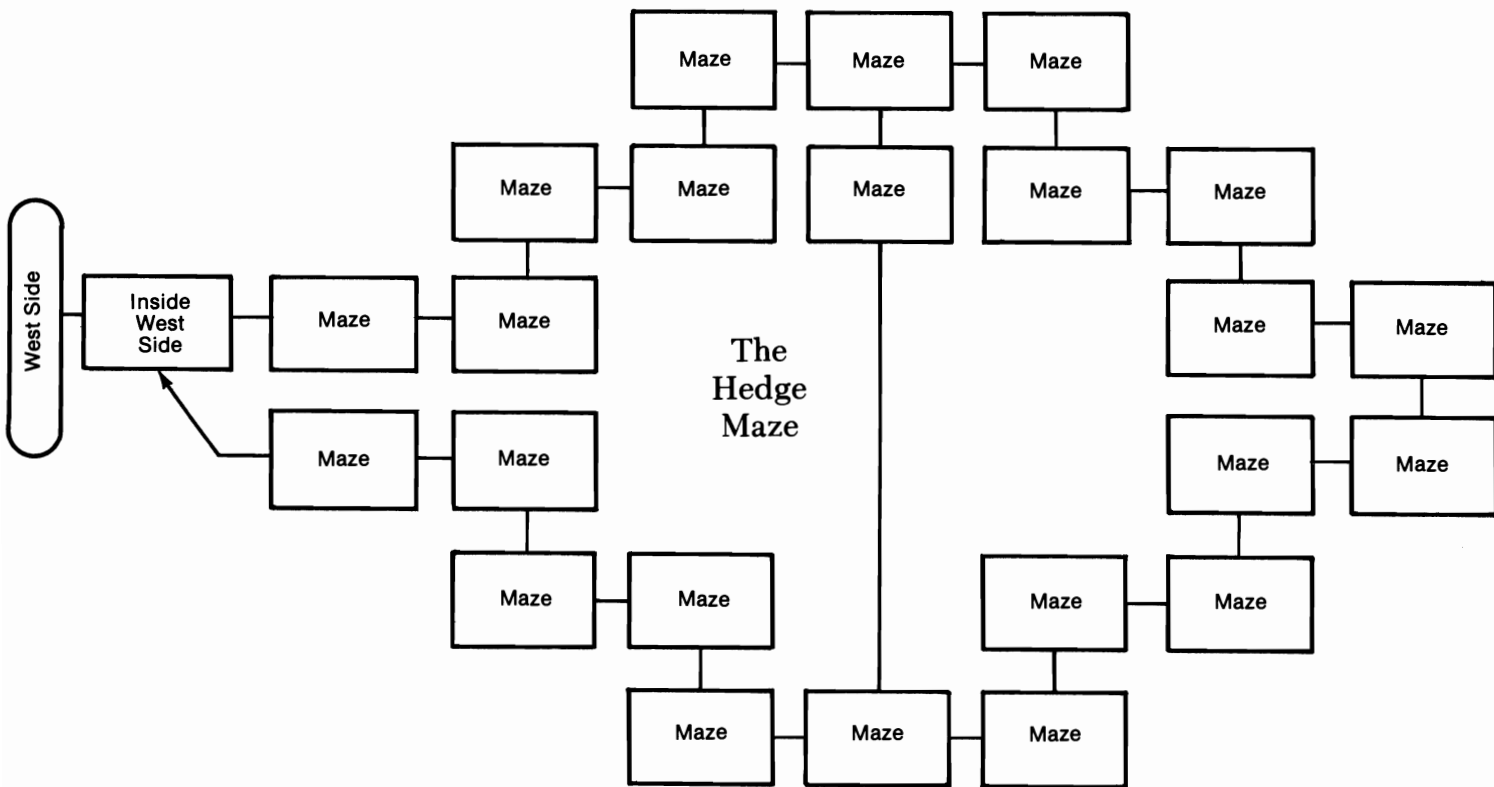

TIME ZONE
Europe 1700AD Paris

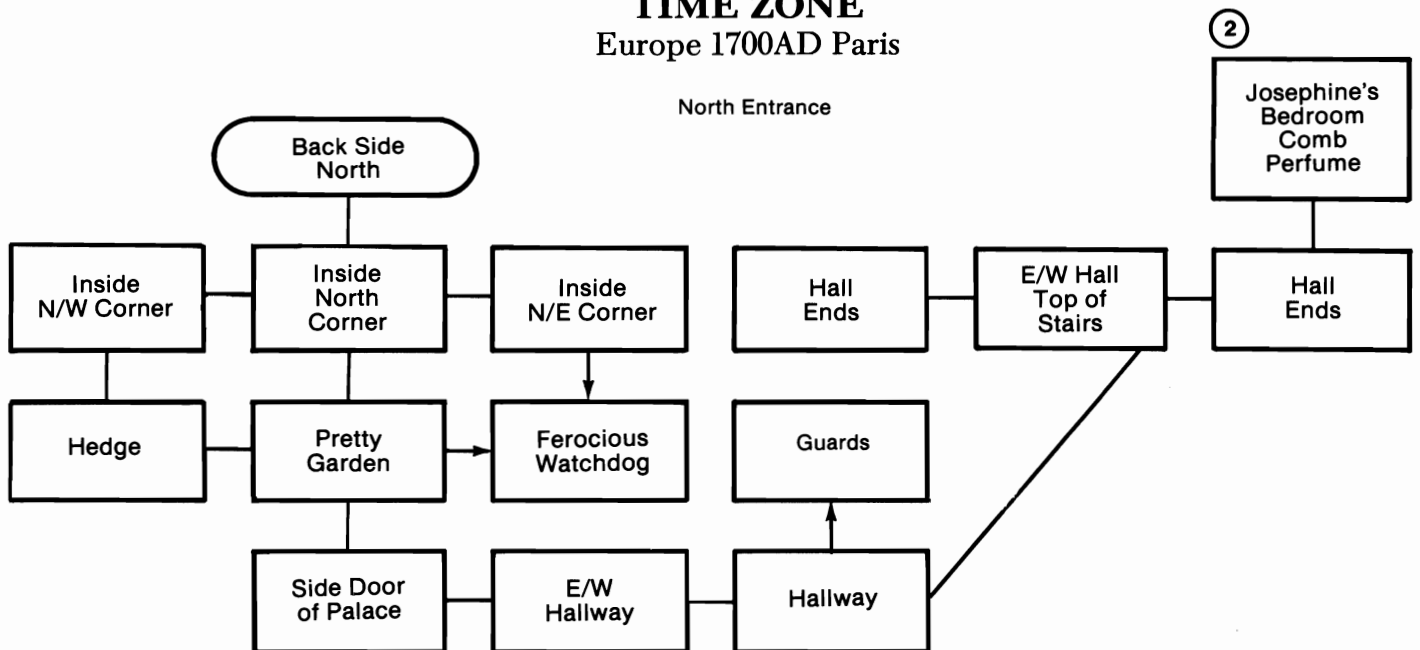

TIME ZONE
 Europe 1400 AD
 Palos, Spain

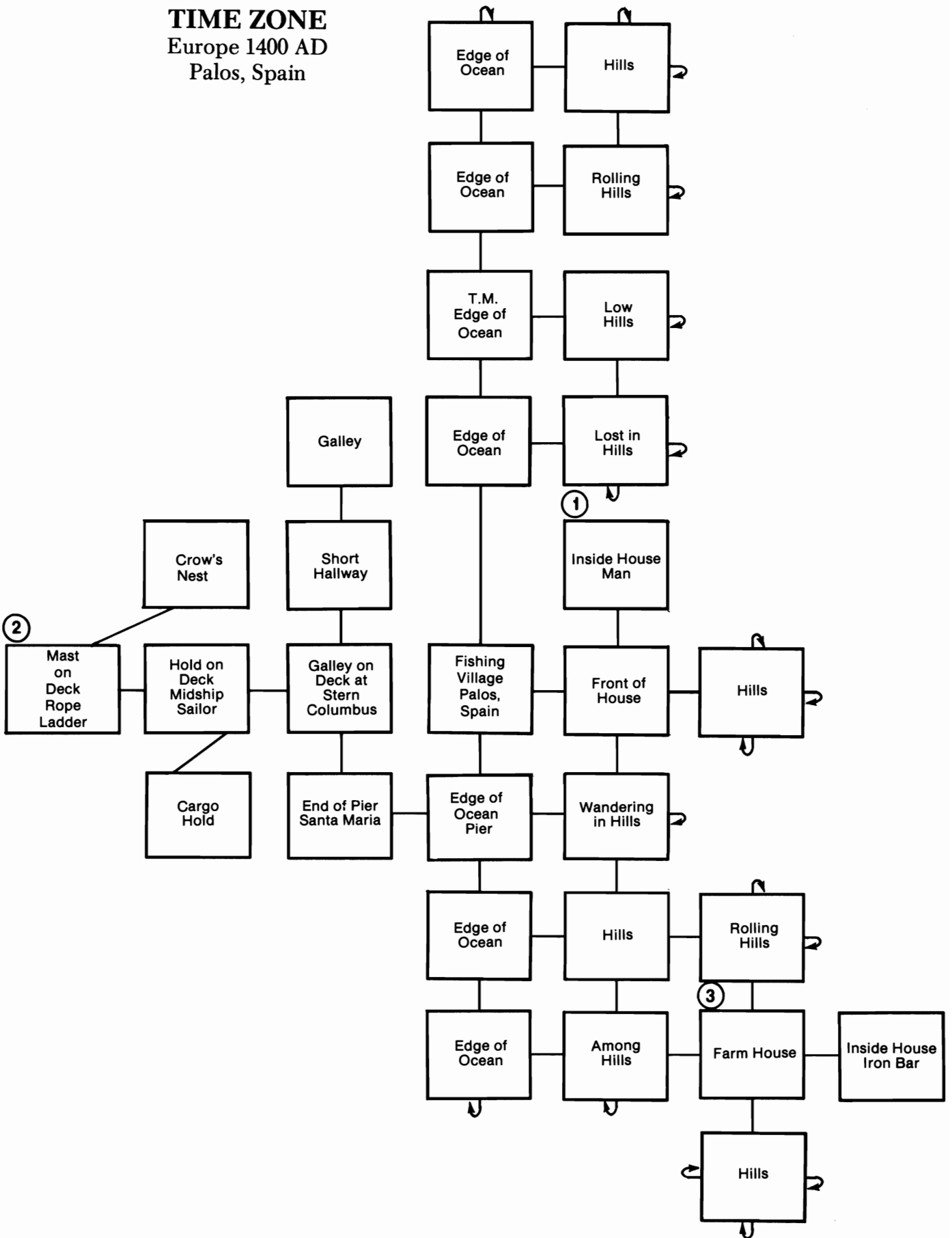

TIME ZONE

Australia 1700 AD

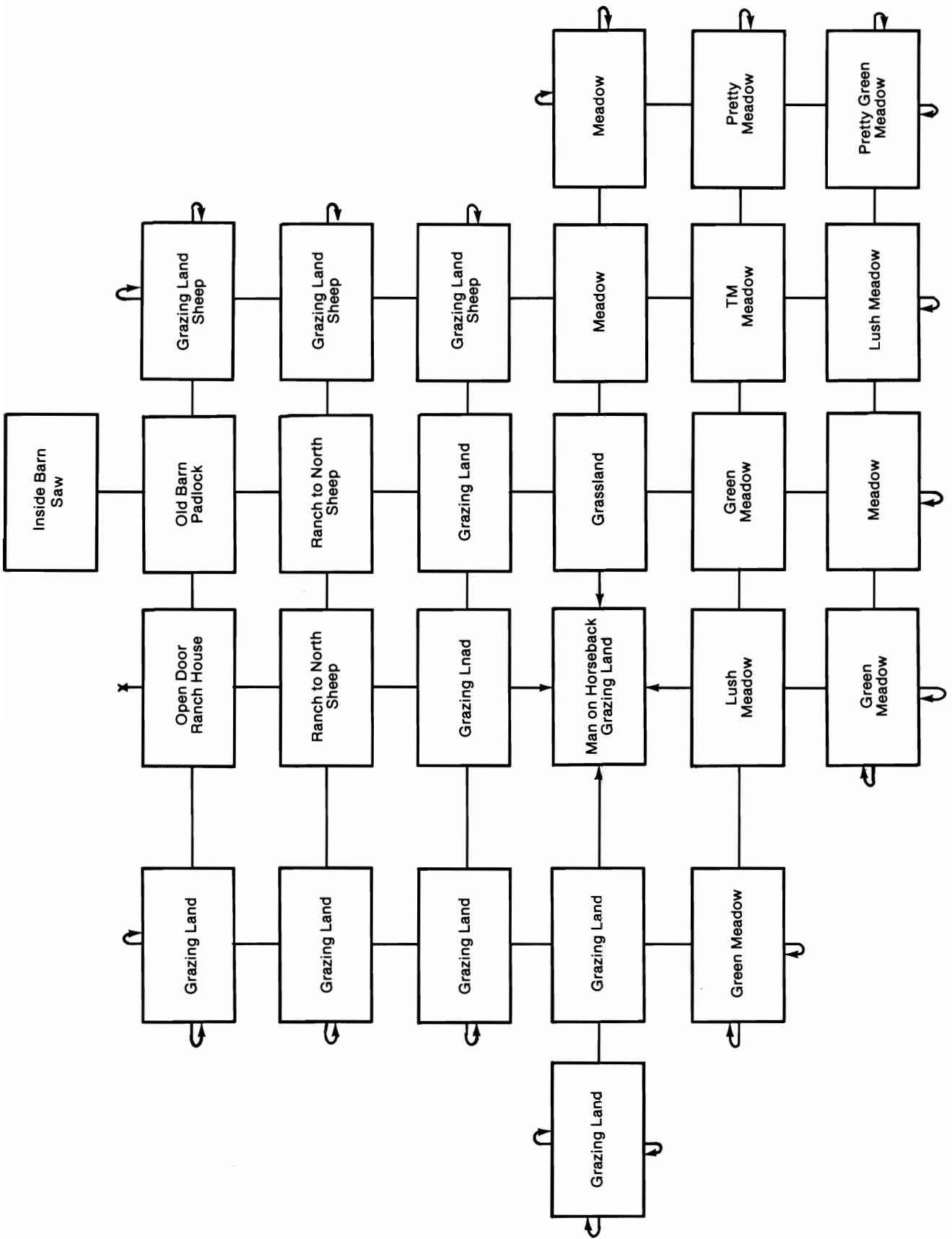

TIME ZONE

North America 1700Ad Philadelphia

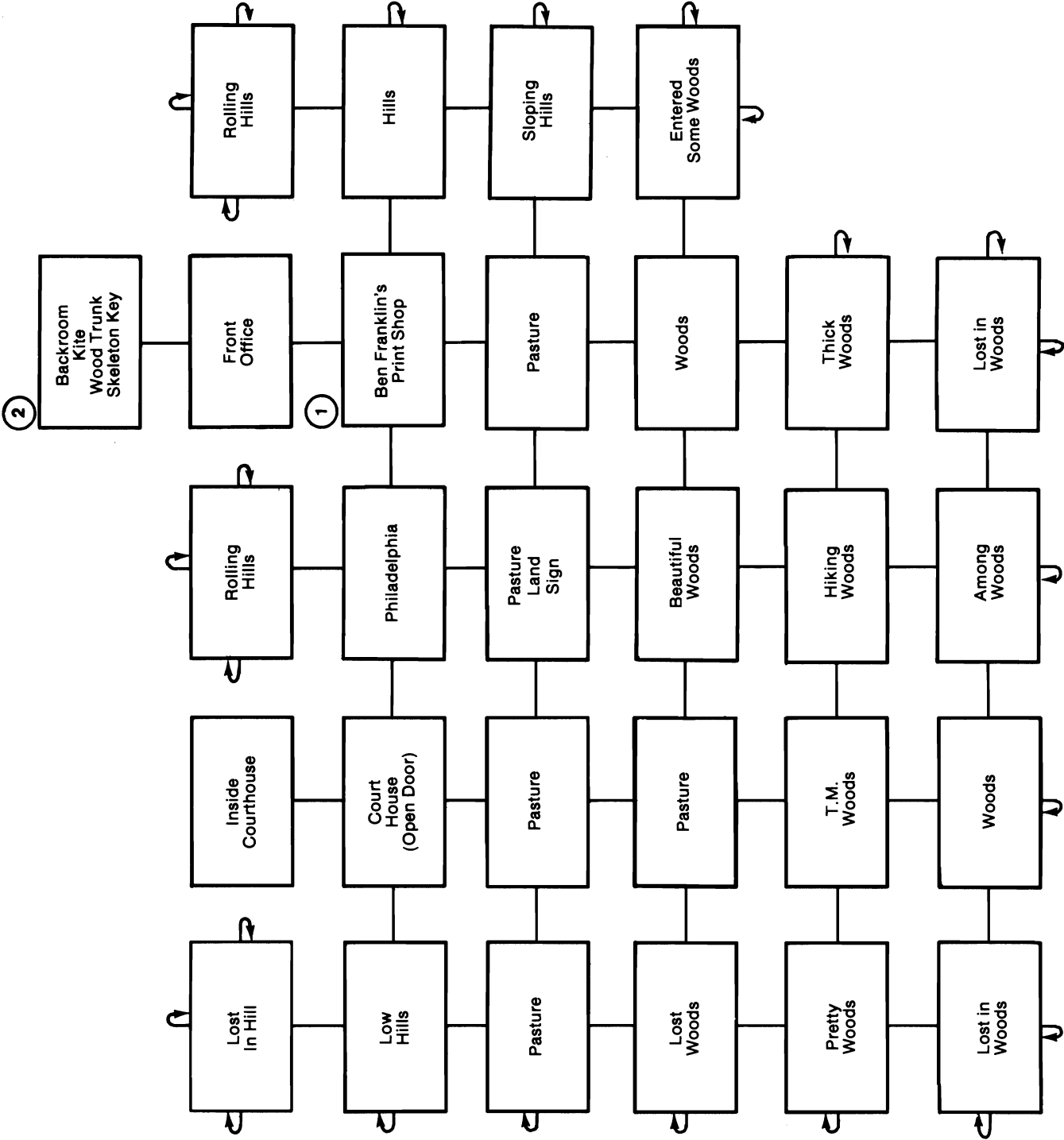

TIME ZONE

Asia/Tokyo 2082 AD

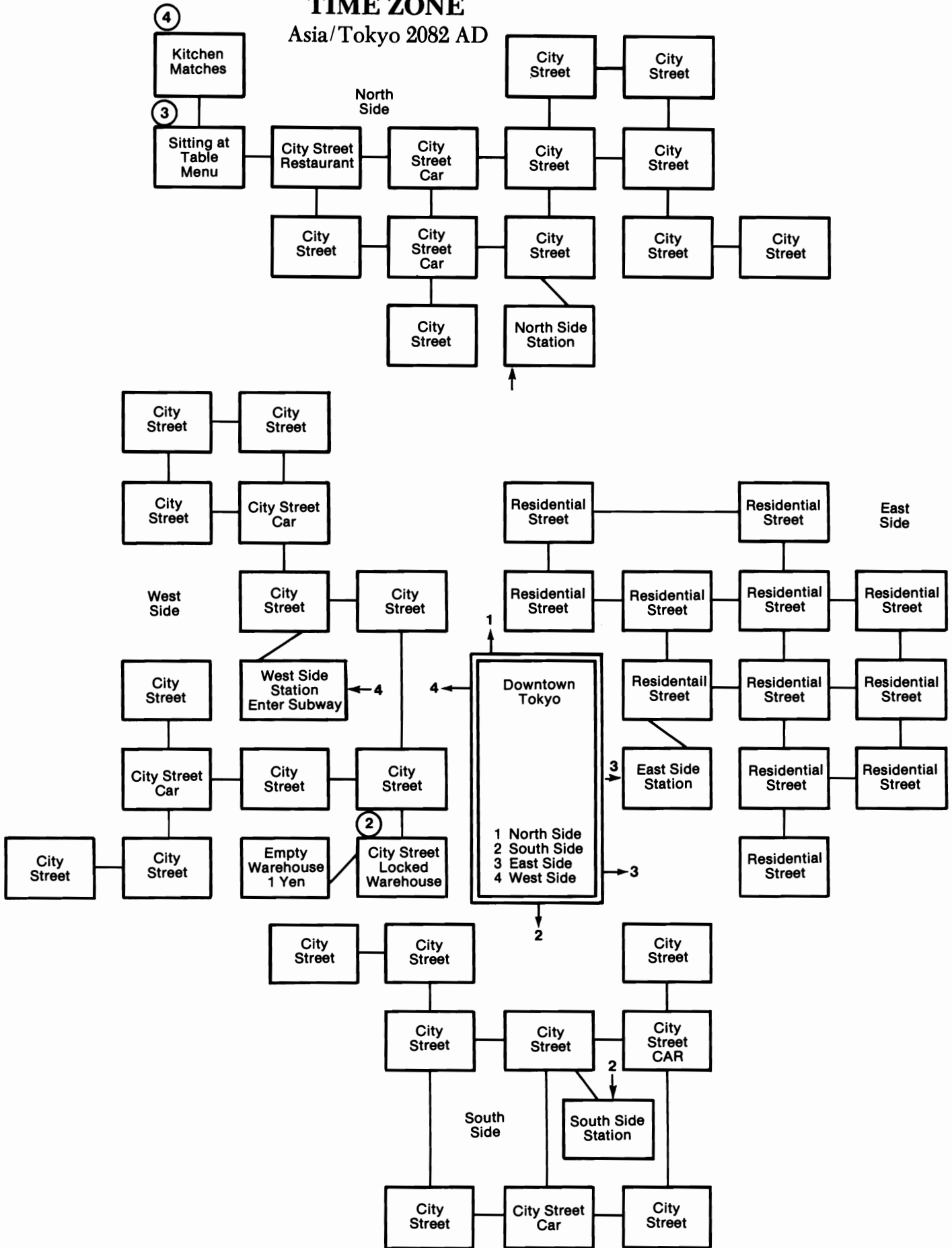

TIME ZONE

Asia 2082 AD Tokyo

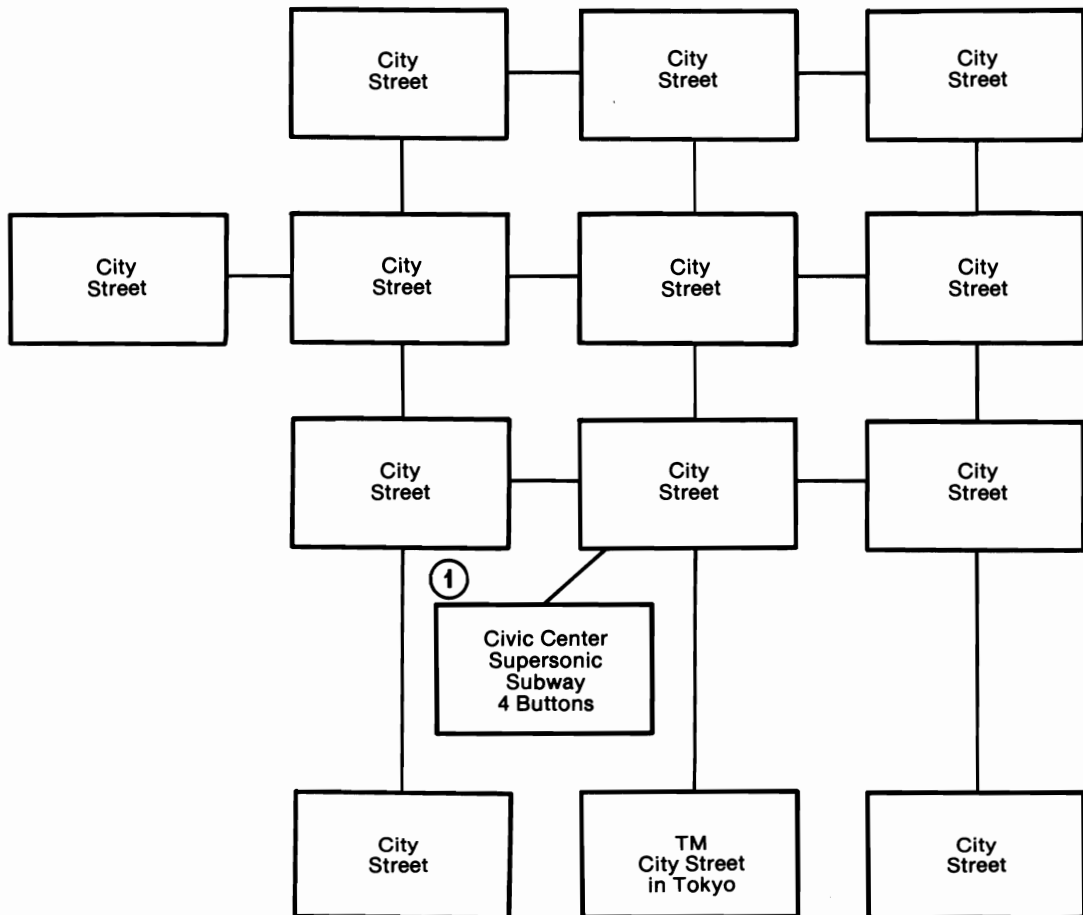

TIME ZONE

North America

Los Angeles 2084 AD

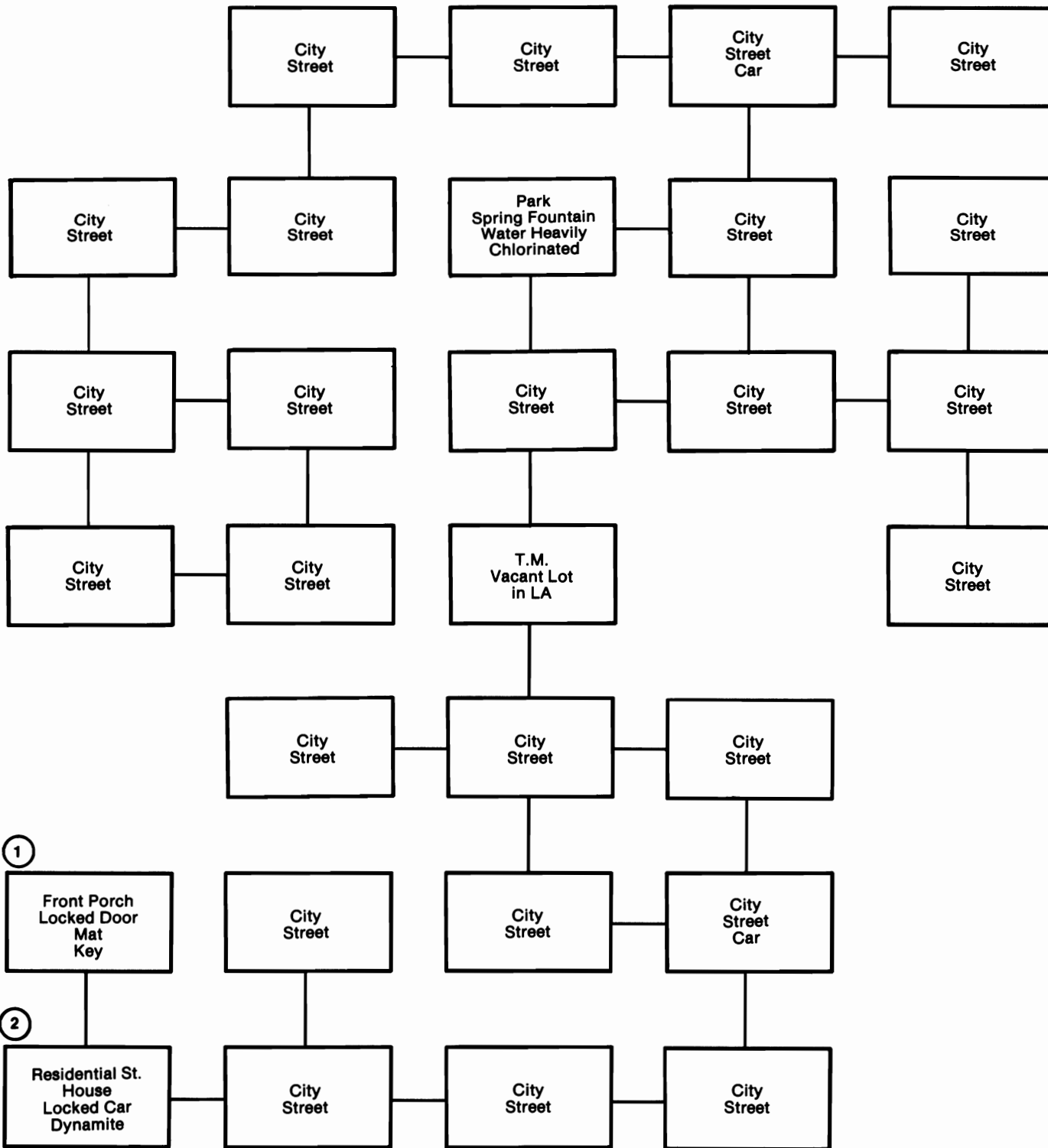

TIME ZONE
Africa 50BC Thebes

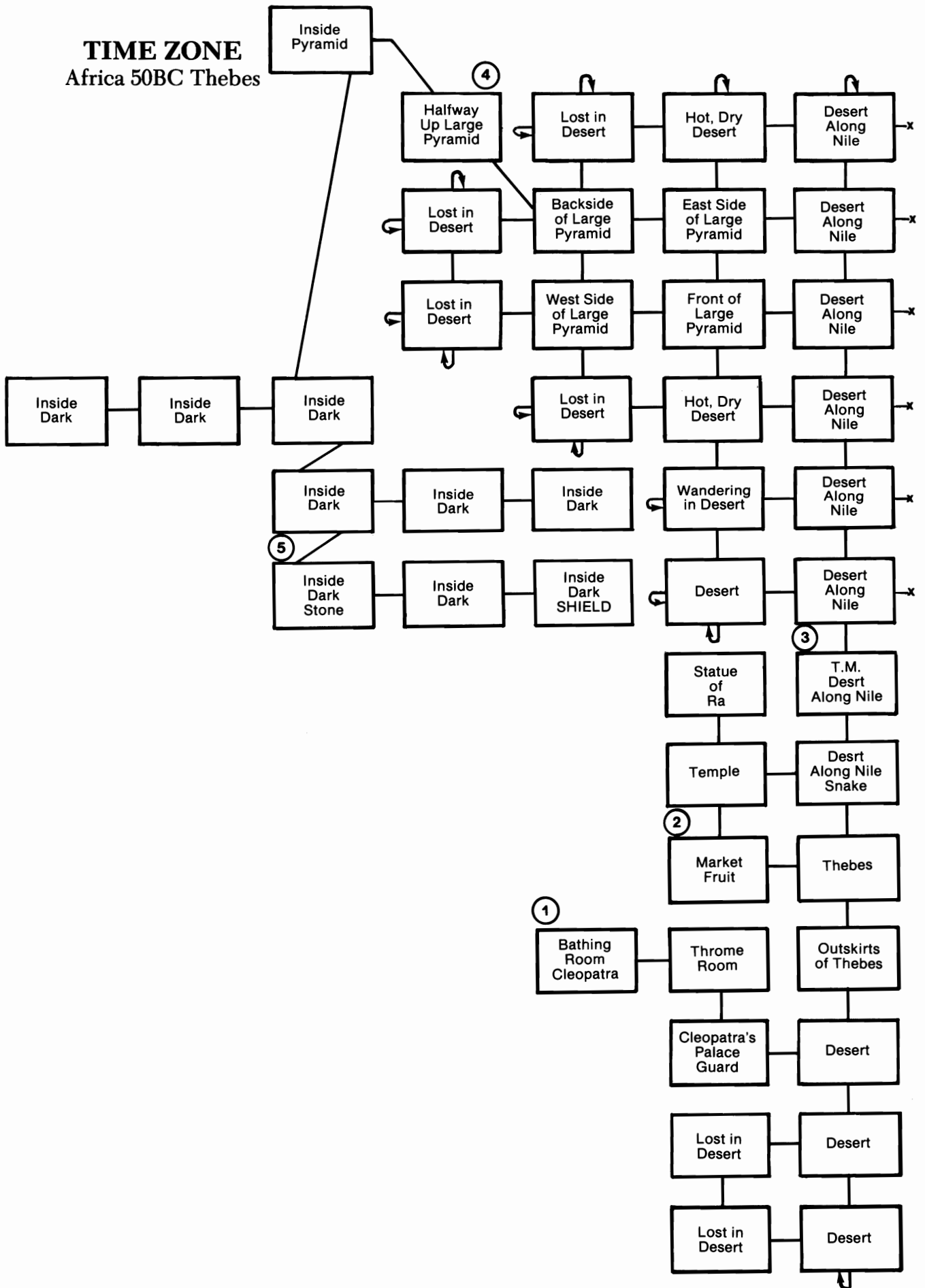

TIME ZONE

Australia 50BC

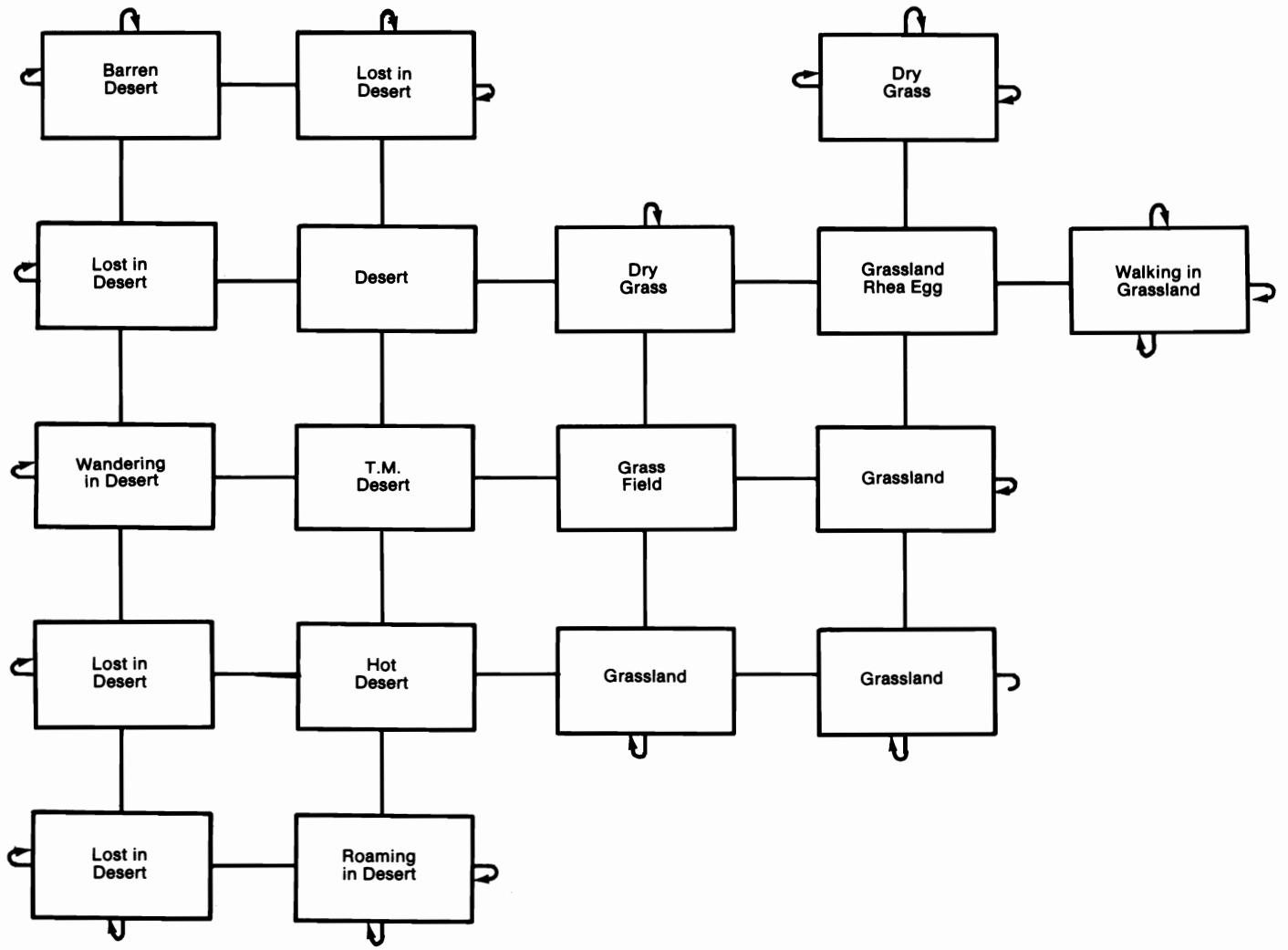

TIME ZONE
 Europe/Nottingham
 1000 AD

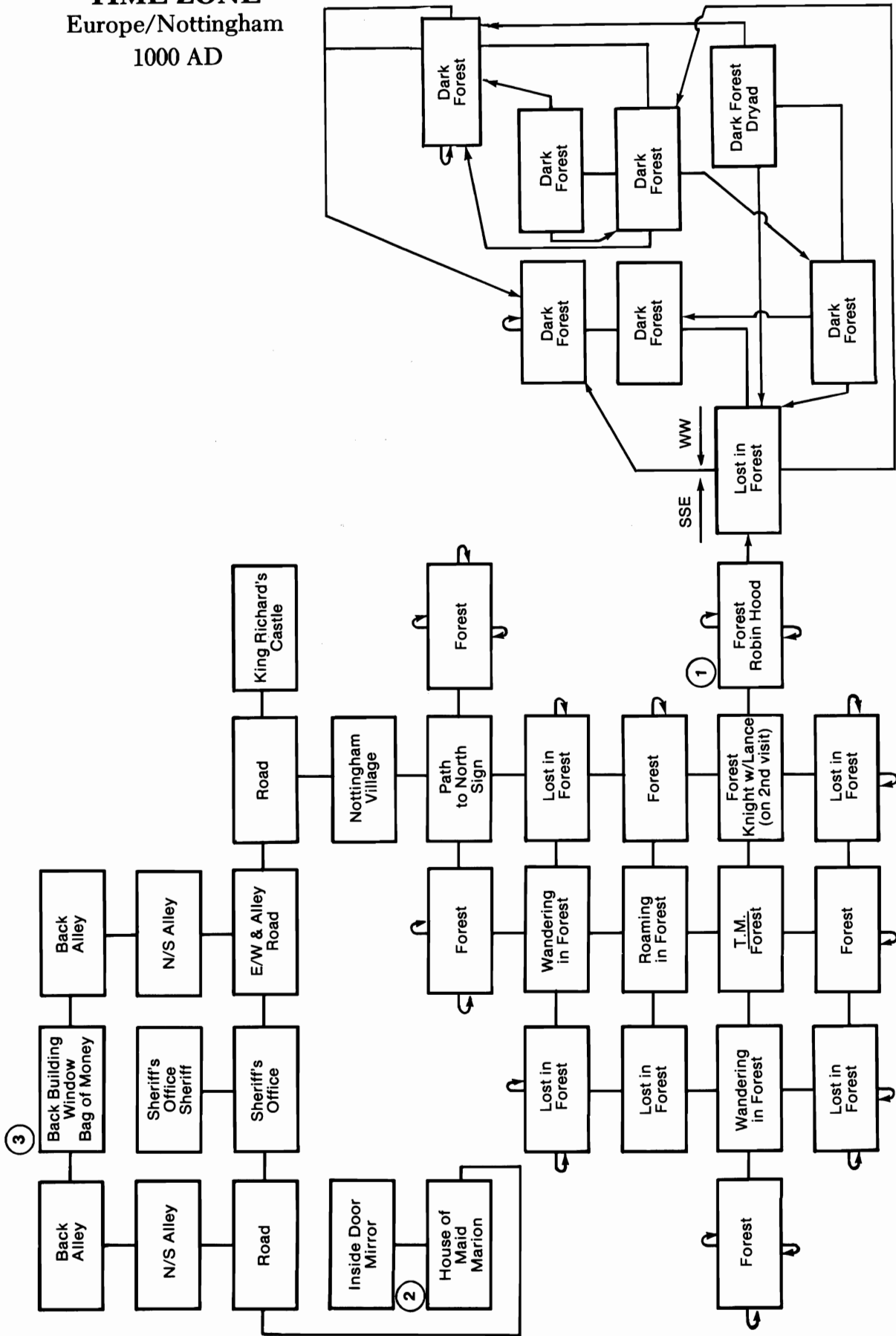

TIME ZONE

Australia 1000 AD

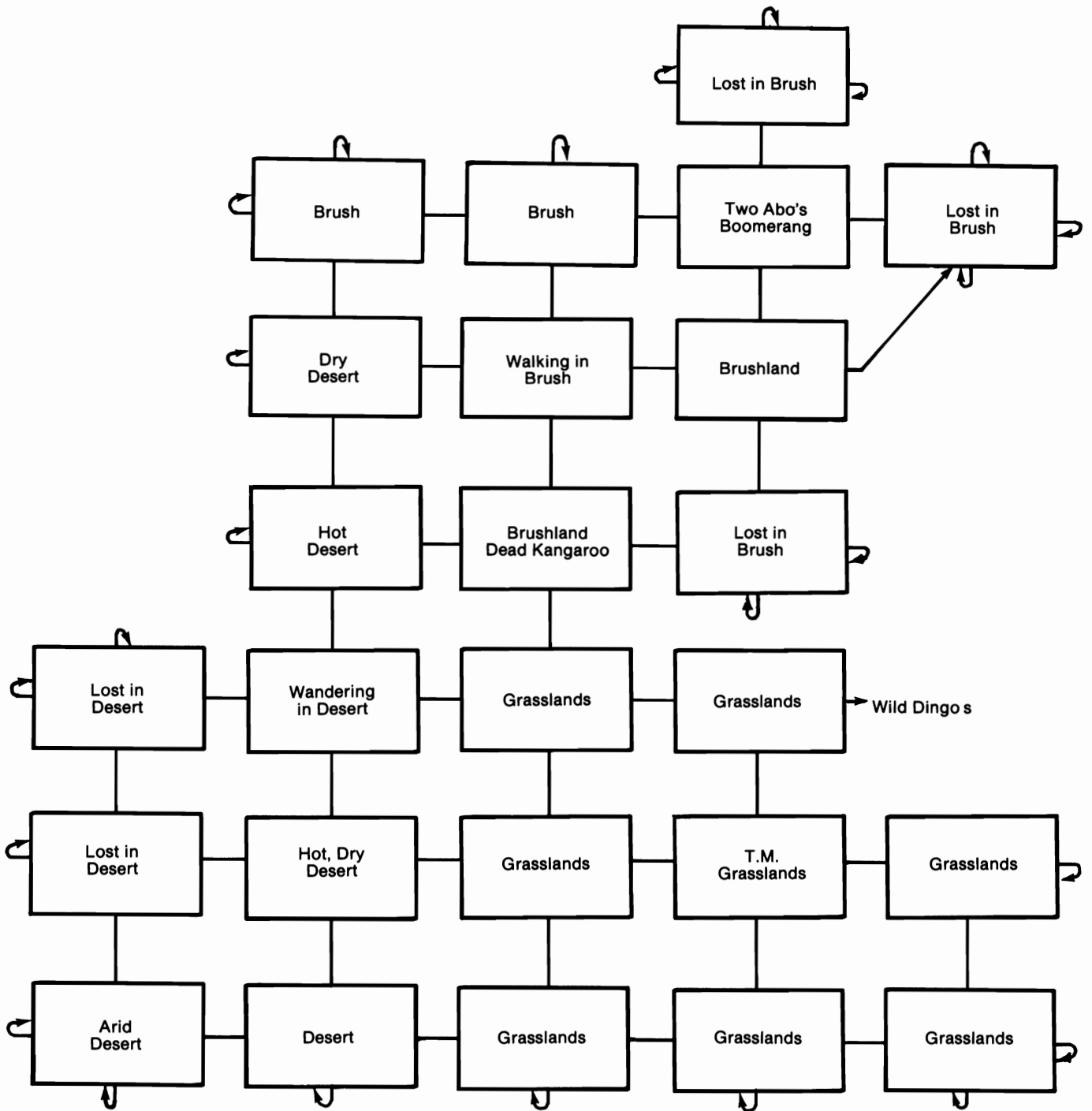

TIME ZONE
Asia 1400 AD Japan

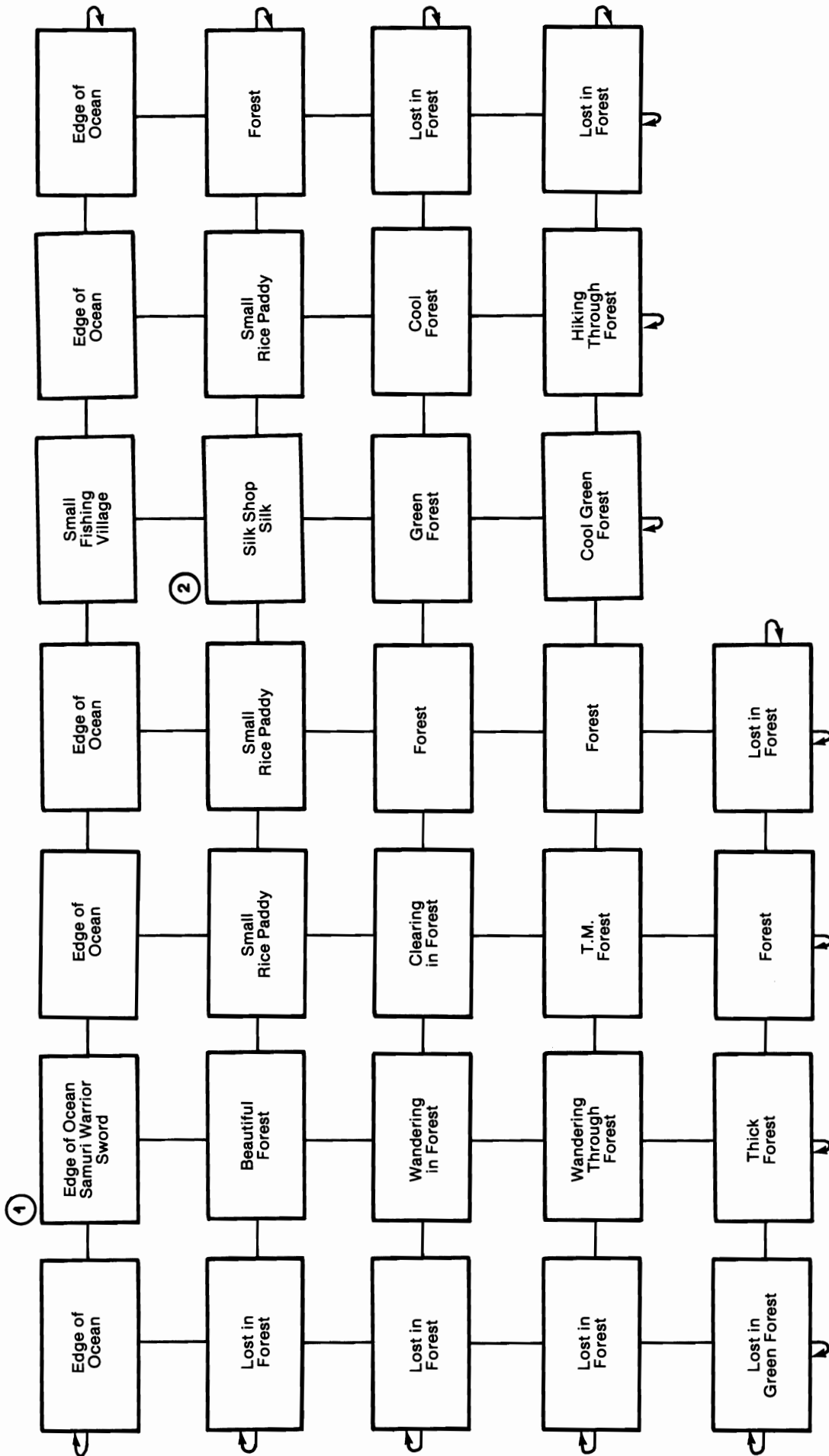

TIME ZONE

Australia/Sydney 2082 AD

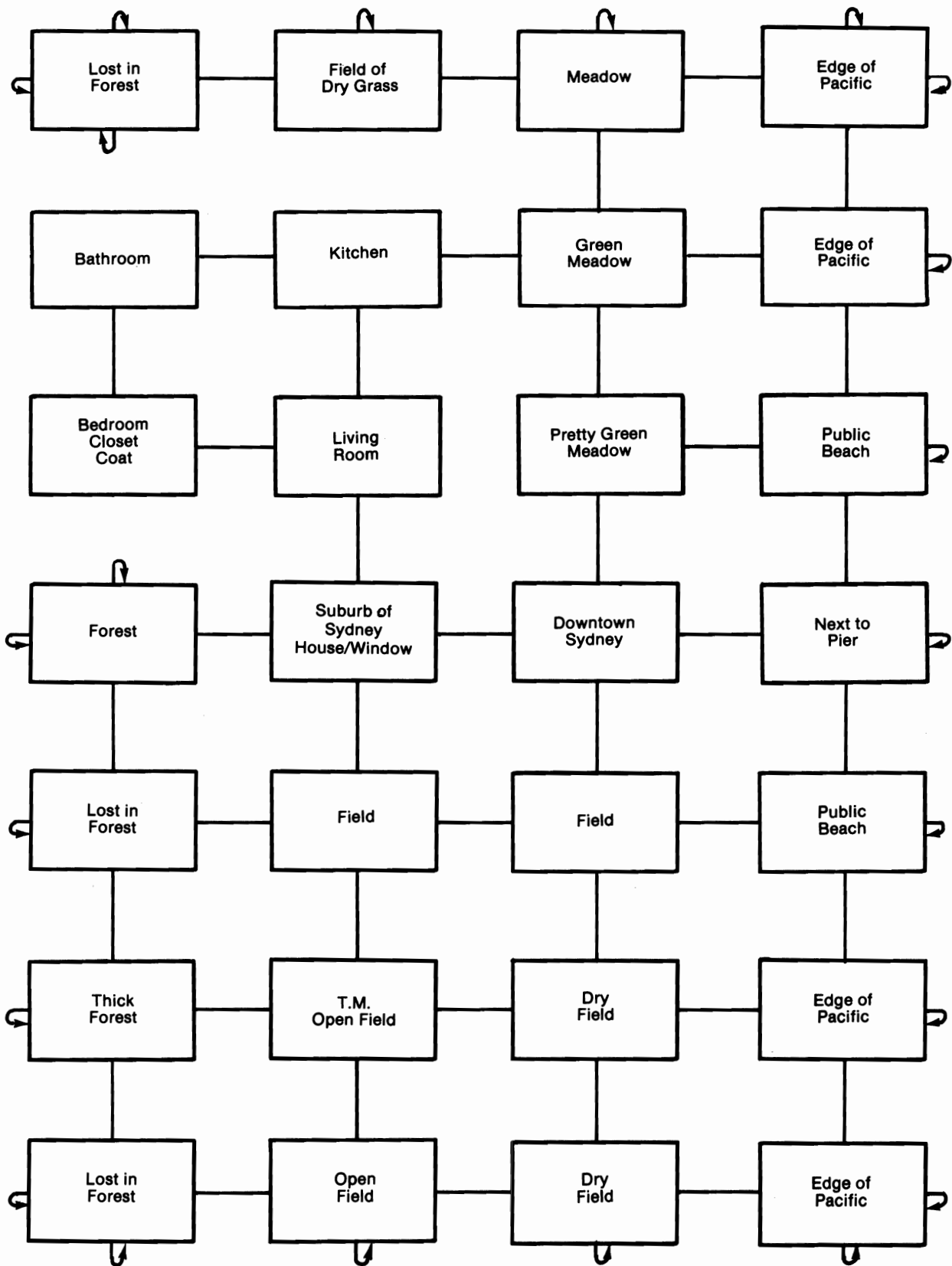

TIME ZONE

Africa 1000 AD Congo

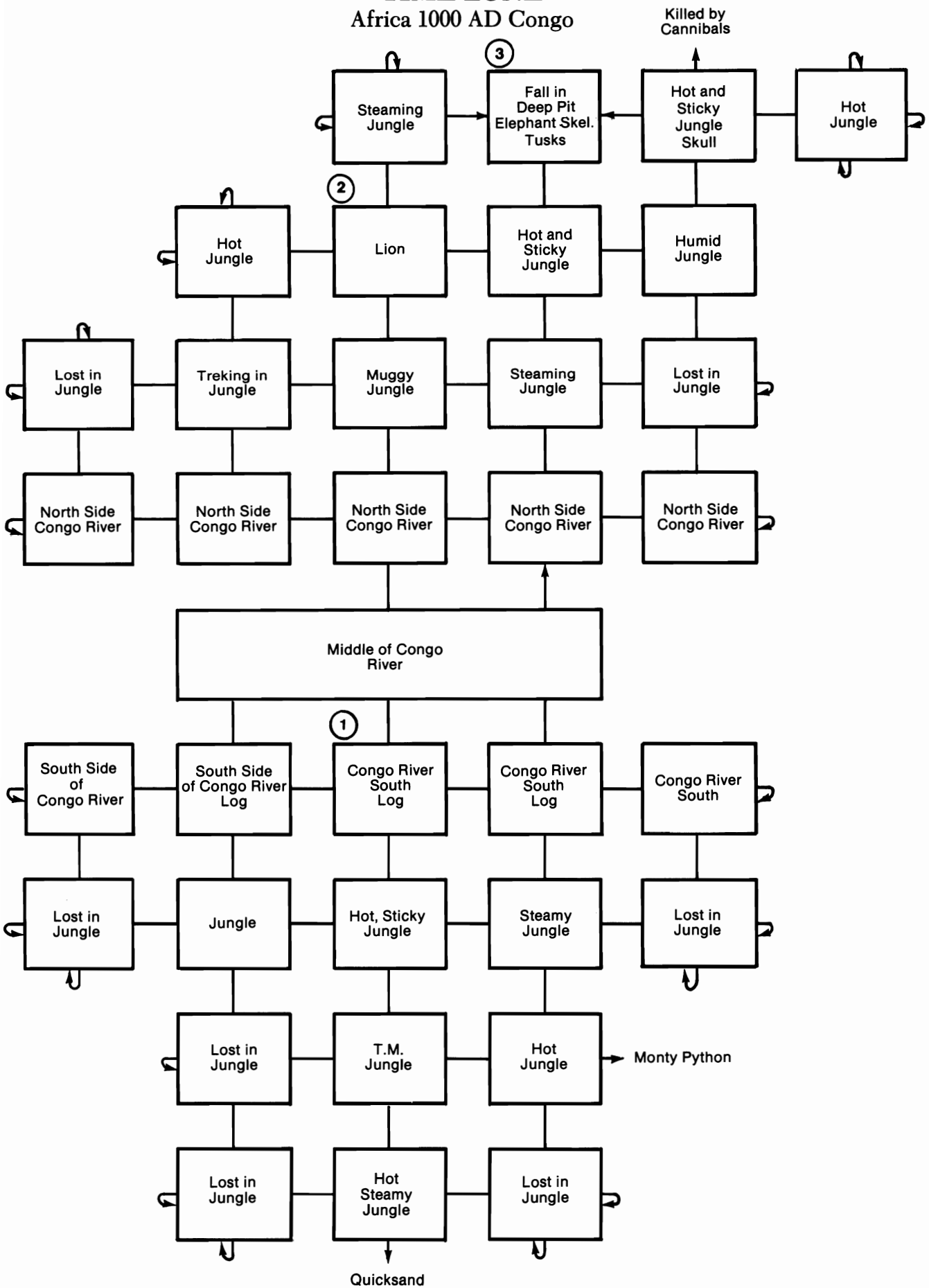

TIME ZONE

Africa 1400AD Morocco

Need Egg
filled w/Water

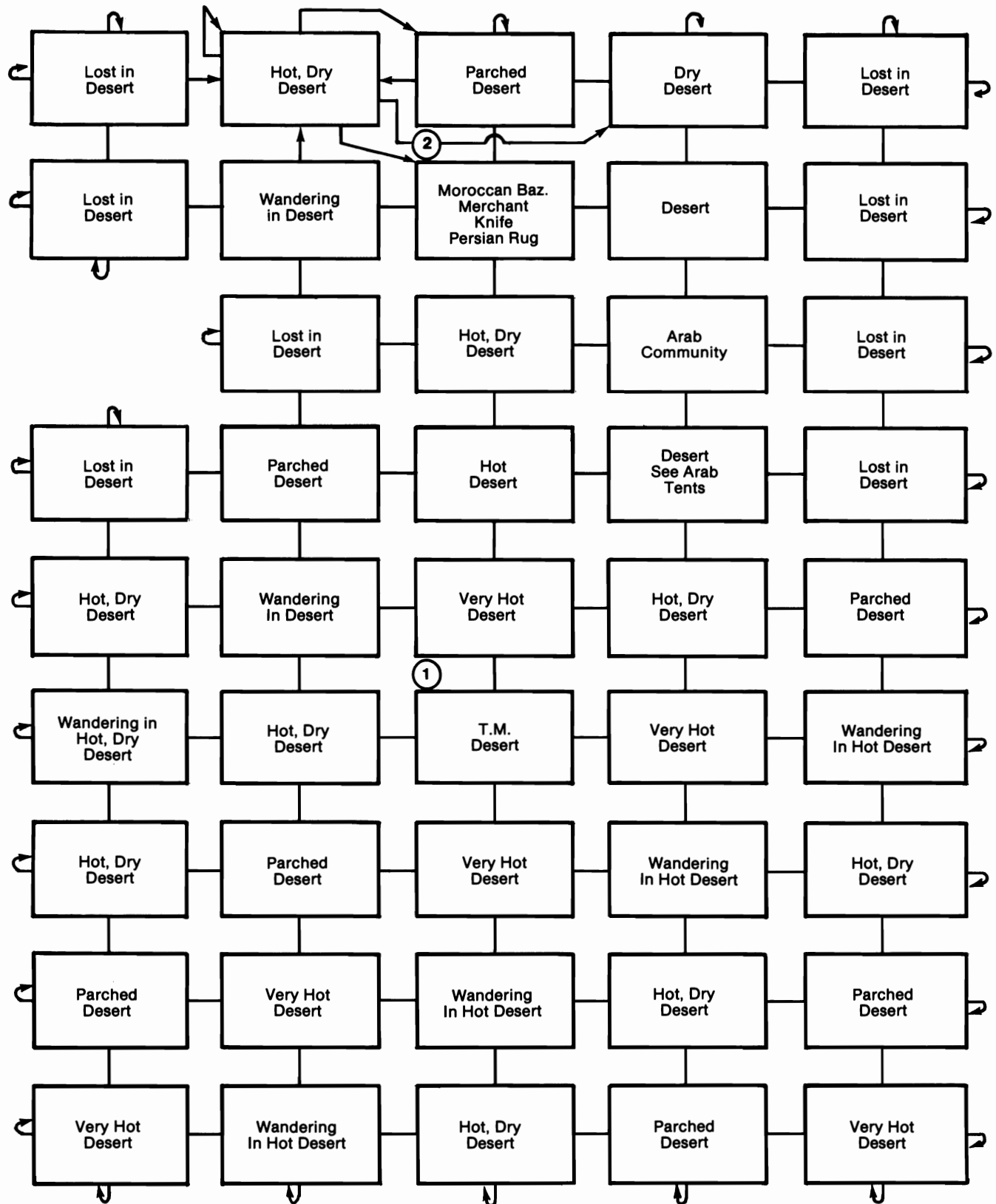

TIME ZONE

Asia 1000 AD
Baghdad

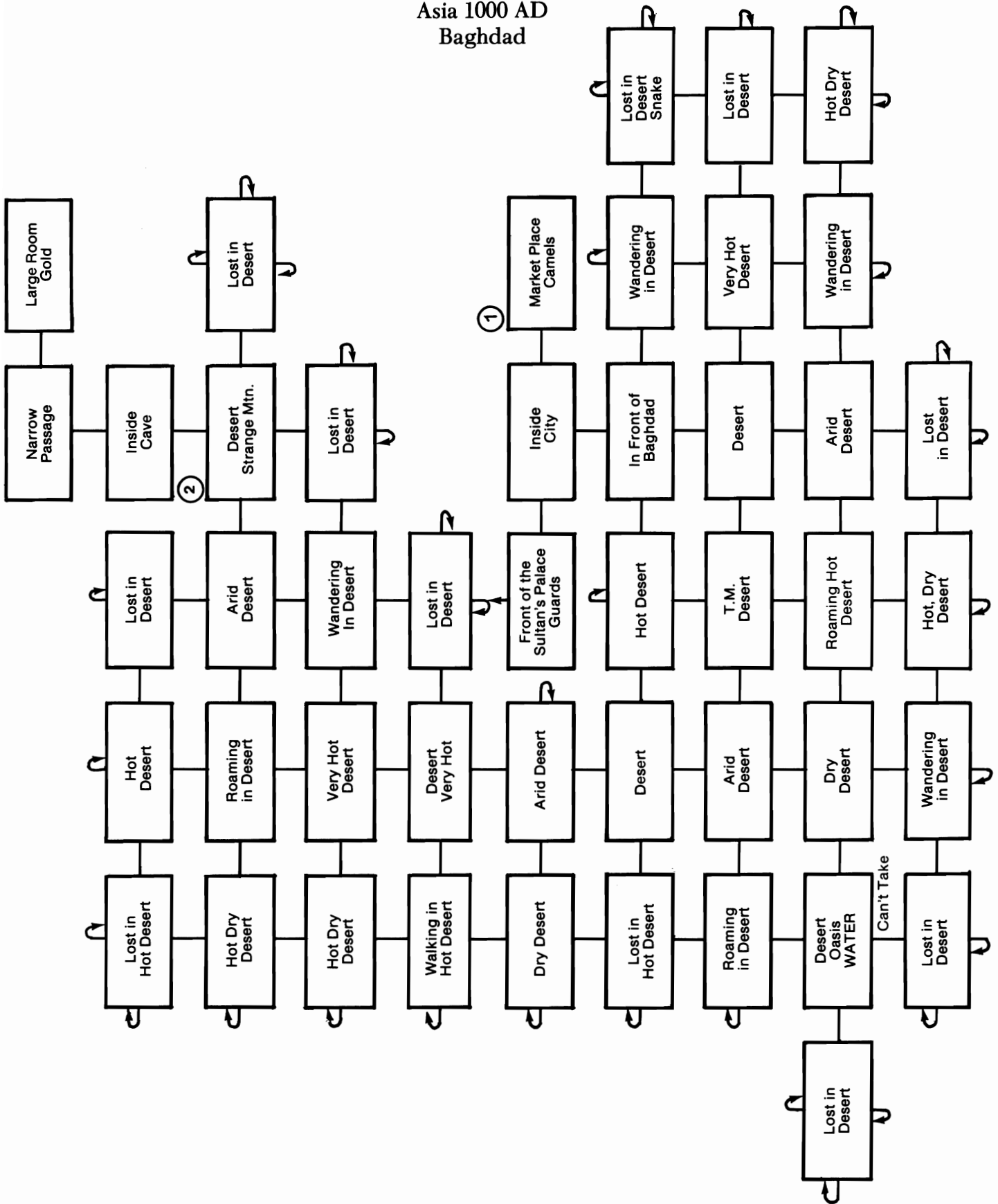

TIME ZONE
Europe/London
2084 AD

Thames

Thames

Thames

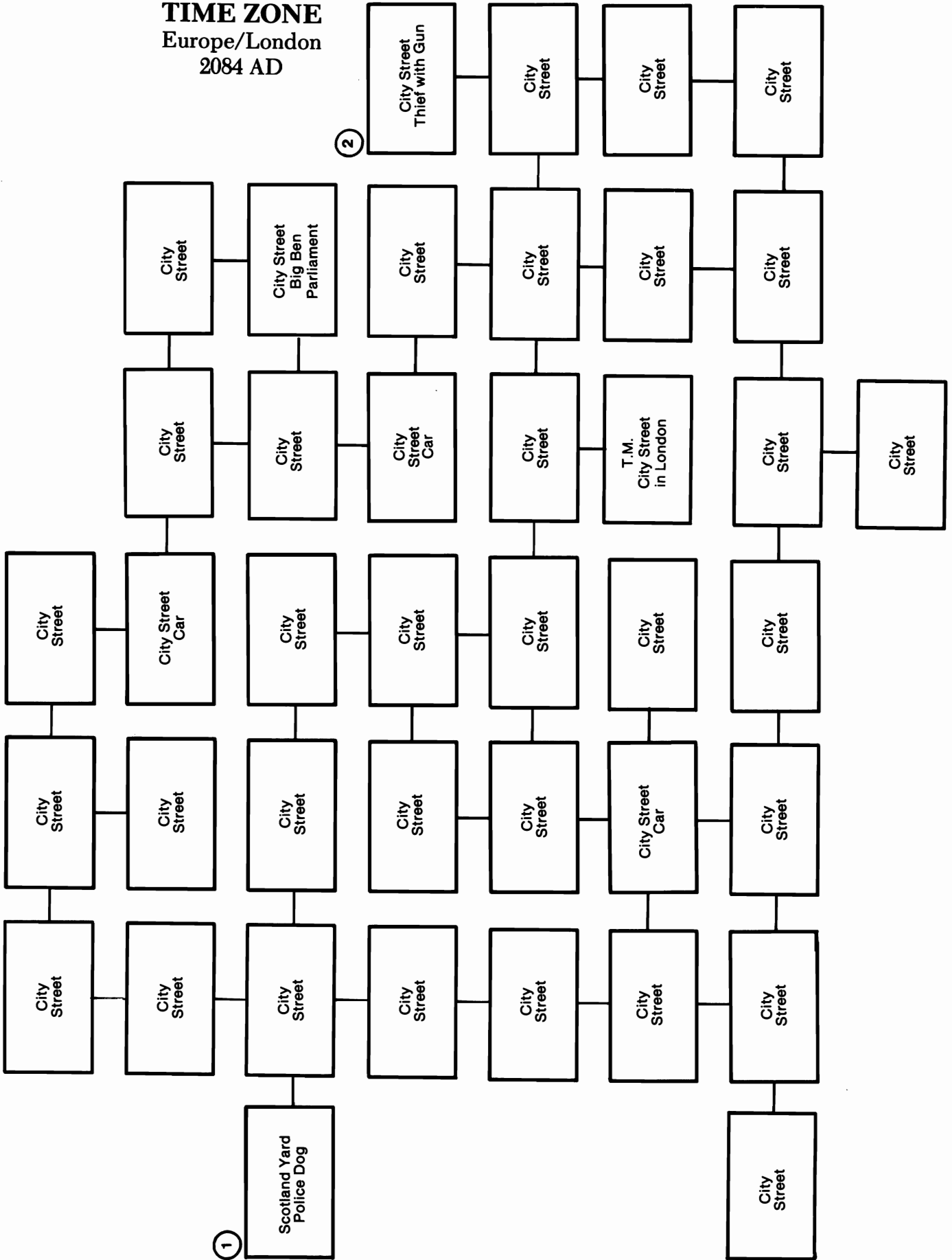

TIME ZONE

10K BC
Stone Age

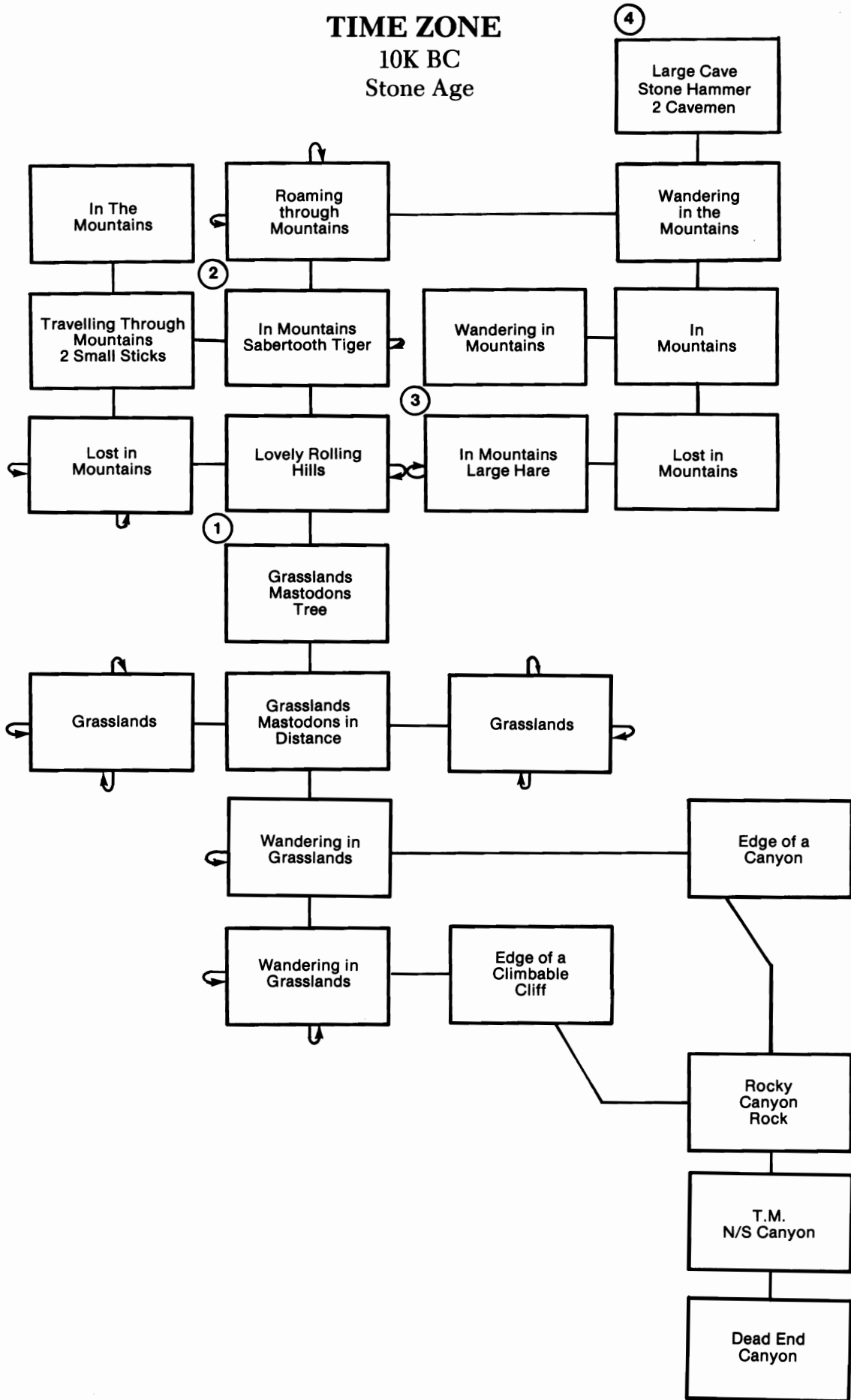

TIME ZONE

Neburon Part II

4082 AD

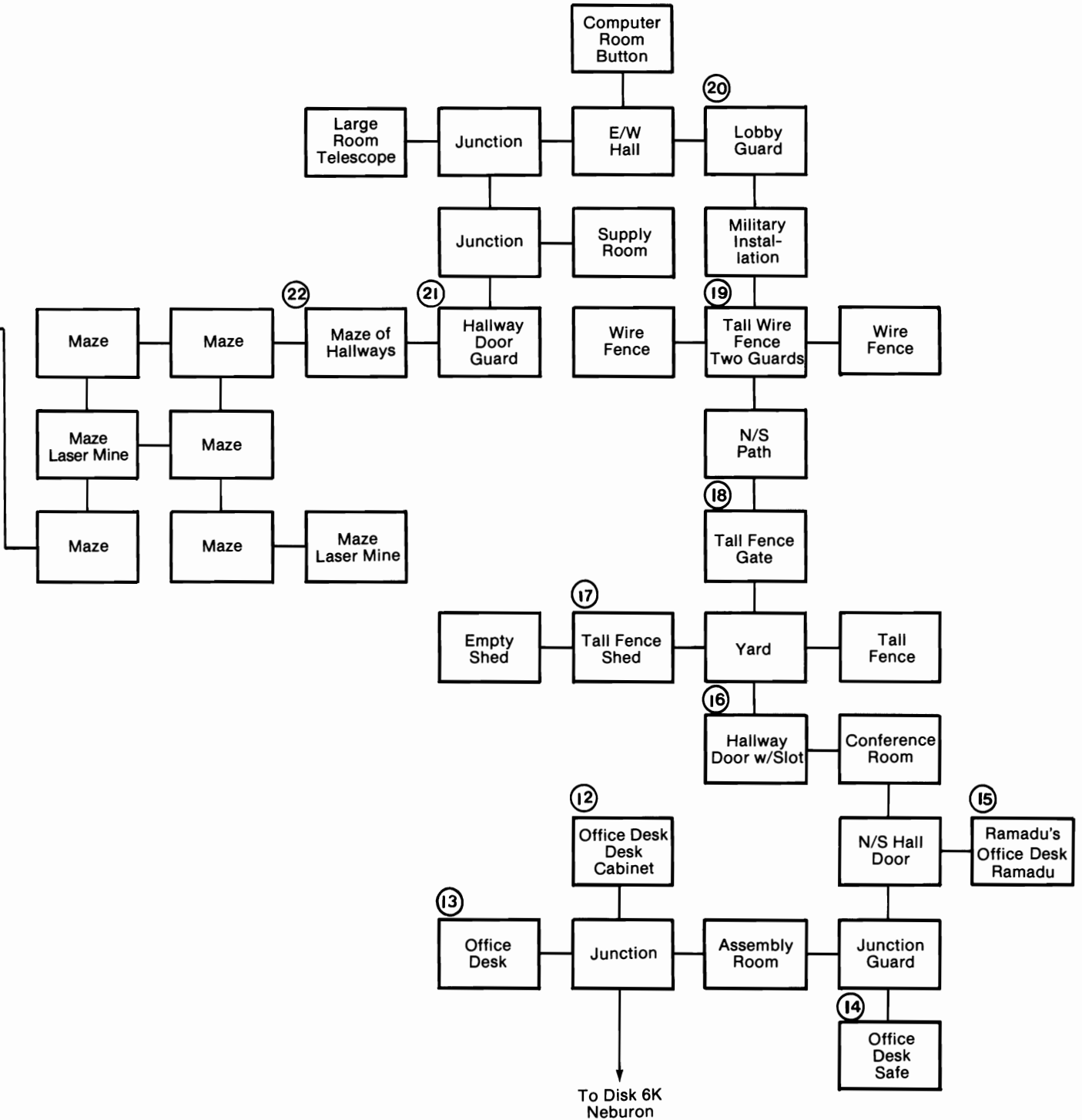

TIME ZONE SEQUENCE

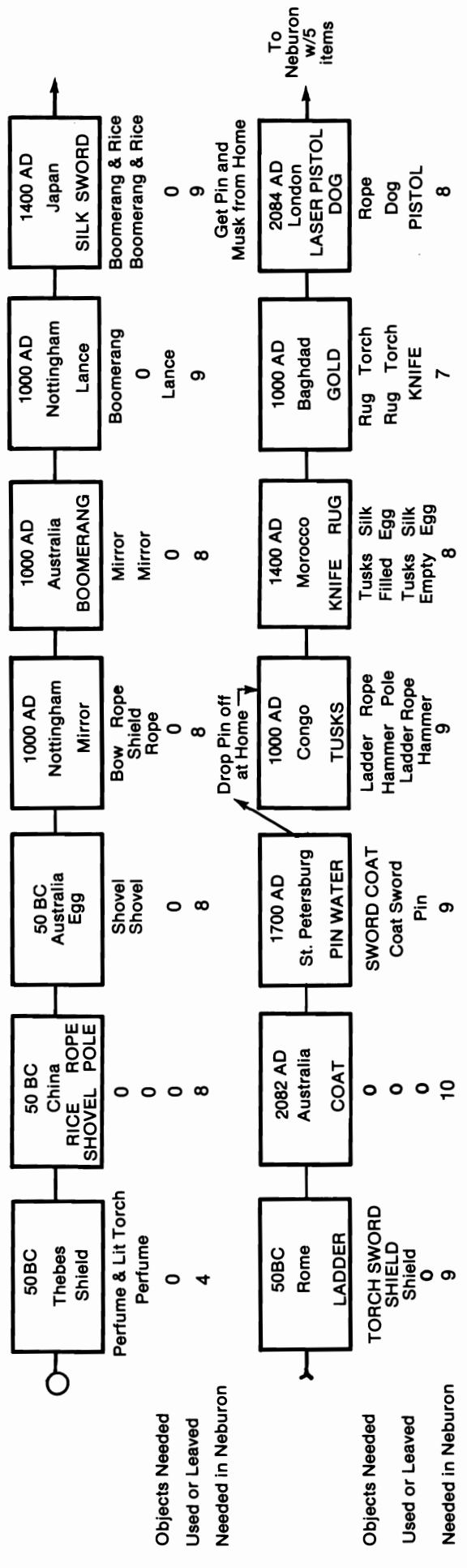
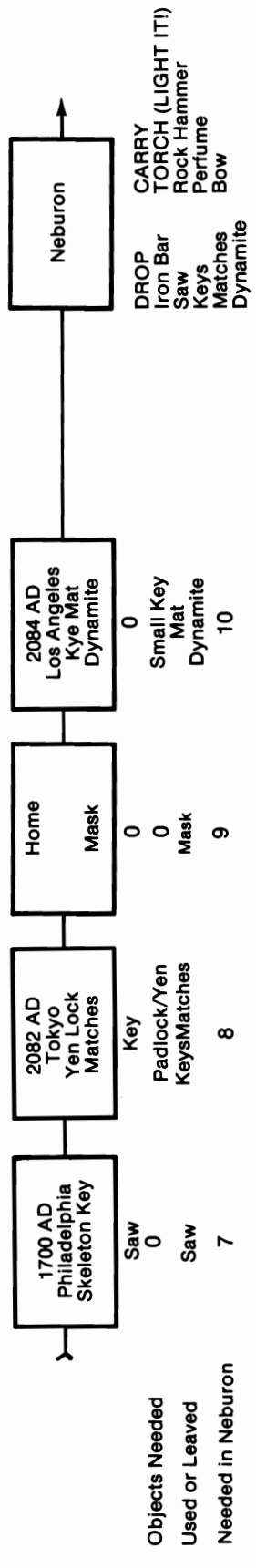
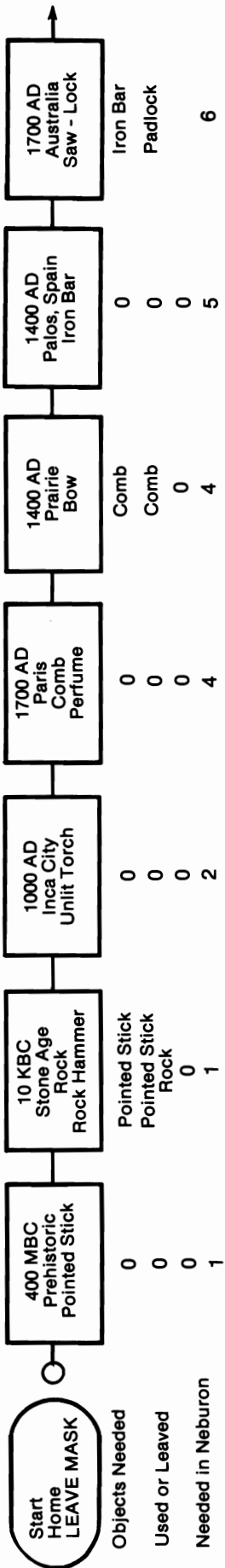

TRANSYLVANIA

Company: Penguin Software

Suggested Retail: \$19.95

Type: A Hi-Res adventure with color graphics.

Description:

You must find the enchanted Princess, Sabrina, break the spell that holds her, and return her safely to the King. If you do not accomplish this task before dawn, Sabrina gets it. The graphics are the strong point of this game, in which you deal with a neatly detailed Werewolf, a well-dressed Vampire, and several moderately interactive puzzles.

Playability:

A bit slow, but the graphics make it worth the wait. No gimmicks, mazes, animation, or anything fancy, but a well-balanced, tongue-in-cheek (although not particularly humorous) game. You save games to a scratch disk, but call them only on the boot cycle. Not too hard for the beginner and interesting enough for the more advanced player.

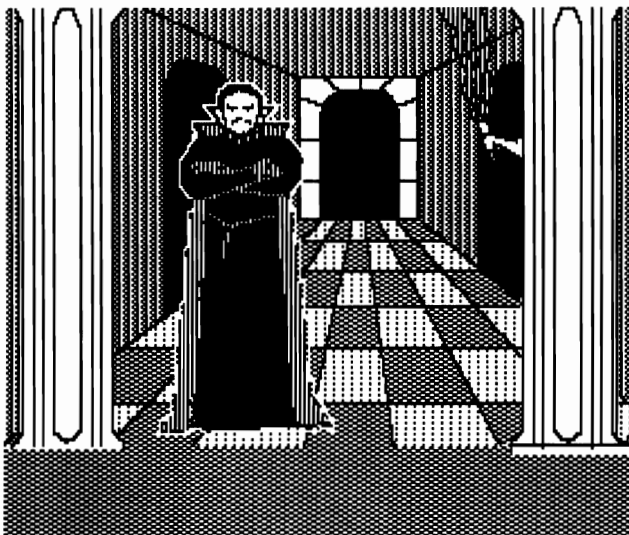

TRANSYLVANIA

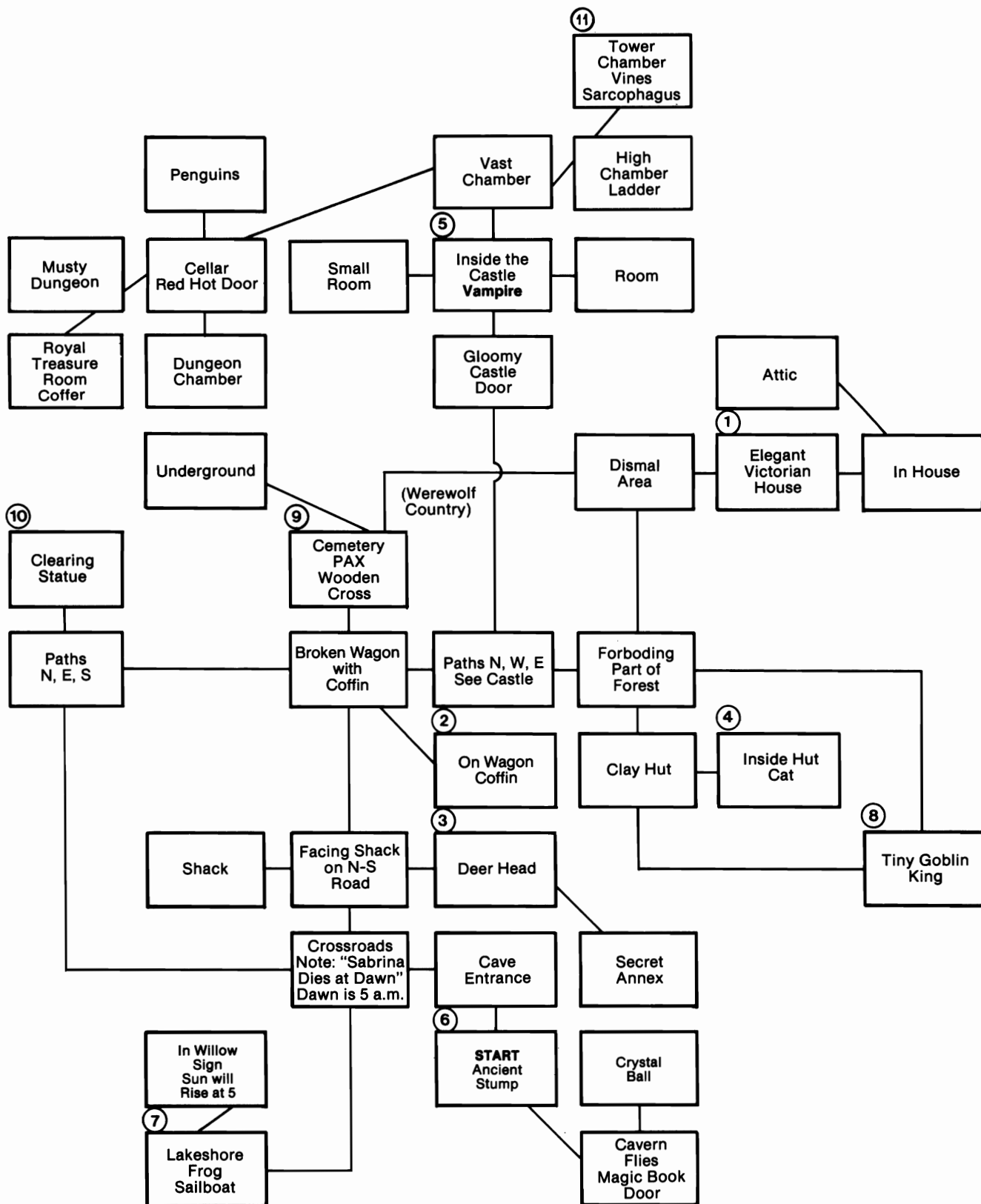

ULTIMA I

Company: California Pacific Computer

Suggested Retail: \$39.95

Type: A Hi-Res fantasy game with color graphics.

Description:

The game starts in the Medieval period, with daggers and leather shields, and progresses through the space age, with blasters and reflective suits. Your *Ultima* role-playing character evolves in experience and attributes through many levels, finally arriving at the "ultimate confrontation" after a trip through time. The game involves eight castles, eight monuments, some thirty-two cities and dungeons, and an eight by eight sector space setting in both Hi- and Lo-Res.

Playability:

The *Ultima* series ranks among the best of the role-playing games. The challenge lies in its sheer massiveness and evolutionary process more than in puzzles. The game can (and should) be saved frequently. However, you cannot recall the game without shutting down your system. No regular solution exists and beating the evil Mondain is lots of work. You'll find a lot of gold-saving and strategic tips elsewhere in this book.

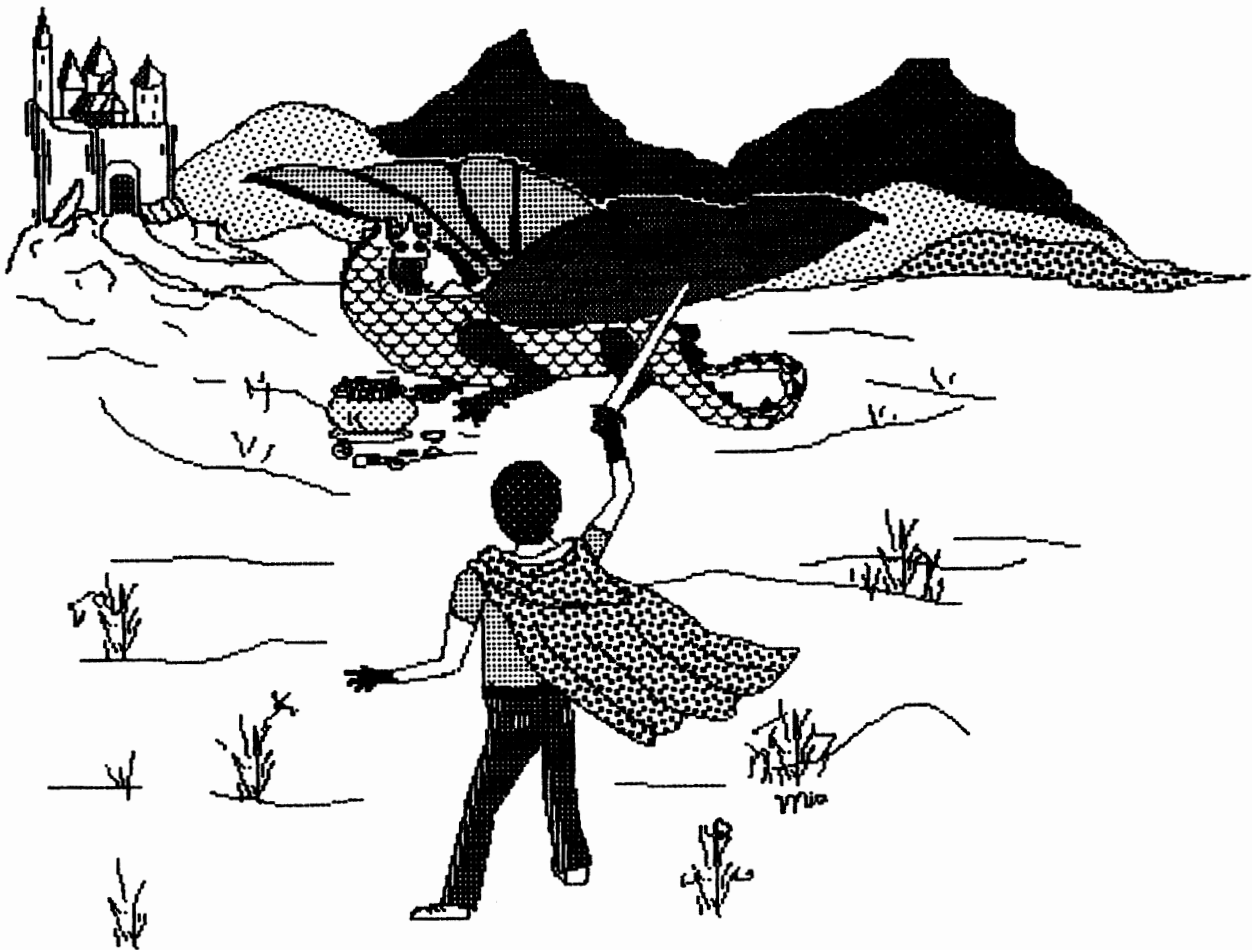

THE LANDS OF ULTIMA I

1	3
2	4

CASTLE
White Dragon
Shimano

QUEST
Grave of Lost Soul
Balron
Level 9

REWARD
Strength
White Gem
+9 Grabs

MONUMENT
Grave of Lost Soul
East Sign Post

GIFT
Stamina
Nothing

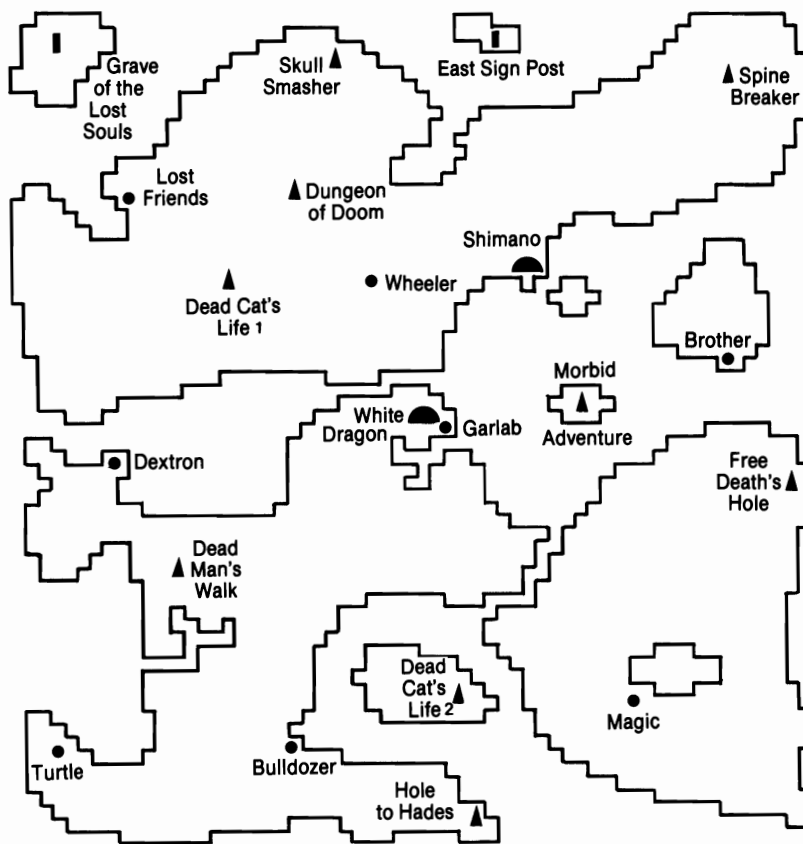

1	3
2	4

CASTLE
Barataria
Rondorlin

QUEST
Pillar of Ozymides
Carrion Creeper
Level 6

REWARD
Strength
Green Gem

MONUMENT
Pillar of Ozymides
Pillar of Argonauts

GIFT
Wisdom
Weapon

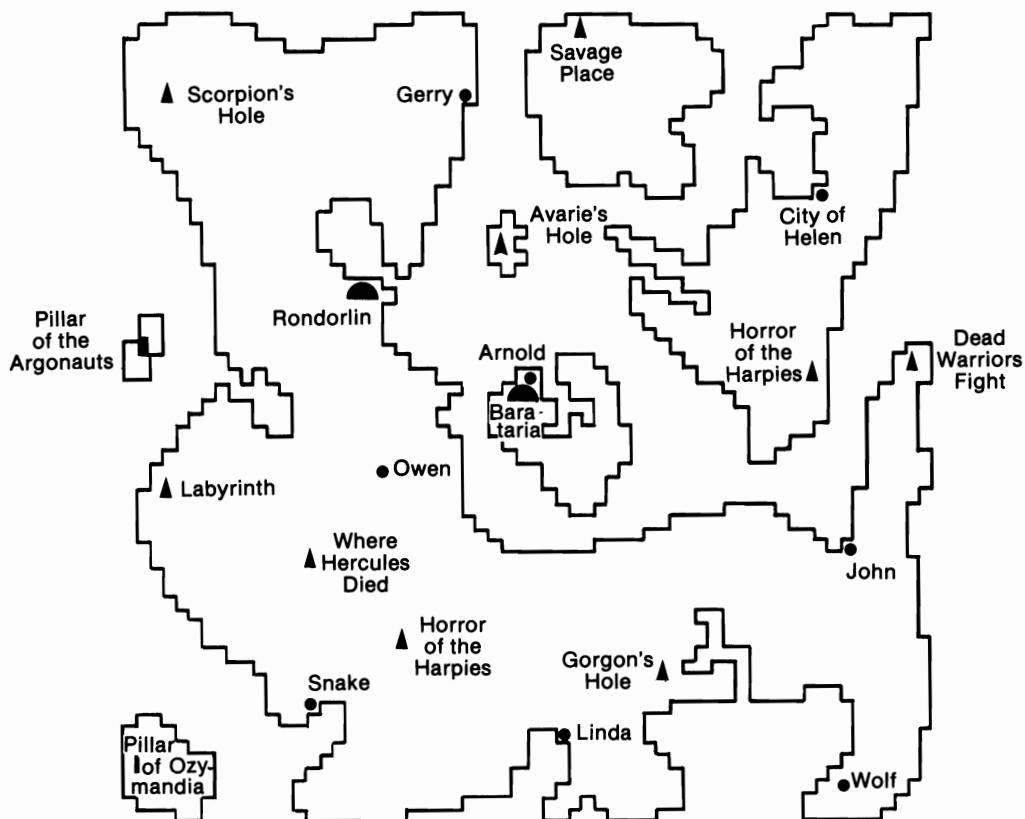

THE LANDS OF ULTIMA I

1	3
2	4

CASTLE

Lord British
Lost King

QUEST

Tower of Knowledge
Gelatinous Cube
Level 3,4

REWARD

Strength
Red Gem

MONUMENT

Tower of Knowledge
Pillars of Protection

GIFT

Intelligence
Agility

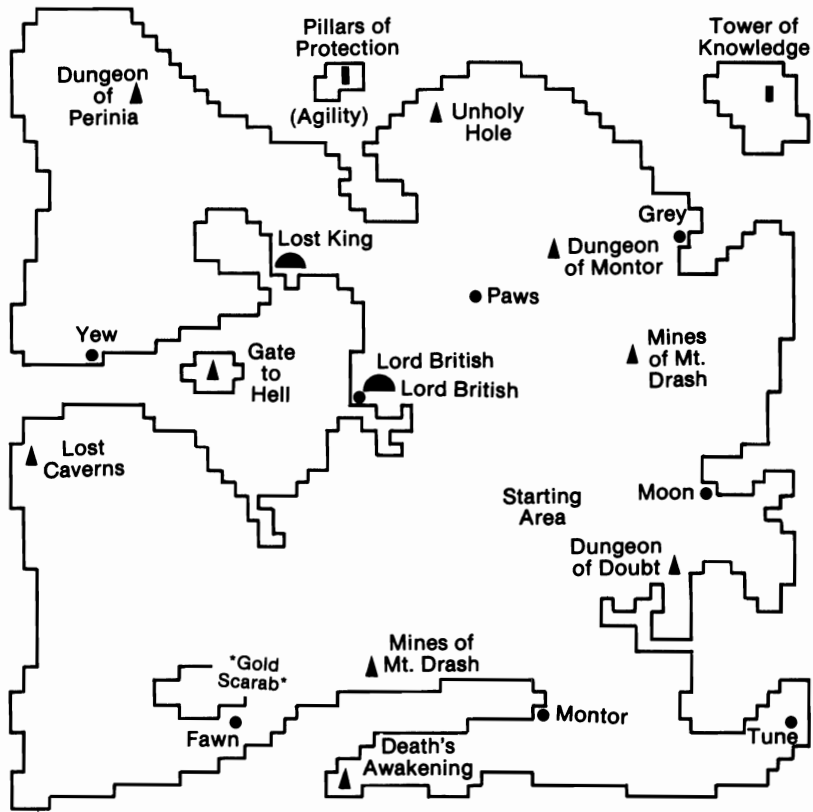

1	3
2	4

CASTLE

Olympus
Black Dragon

QUEST

Find The Sign Post
Kill a Lieche (~level 5)

REWARD

Strength
Blue Gem

MONUMENT

Sign Post
So. Sign Post

GIFT

Stamina
Charisma

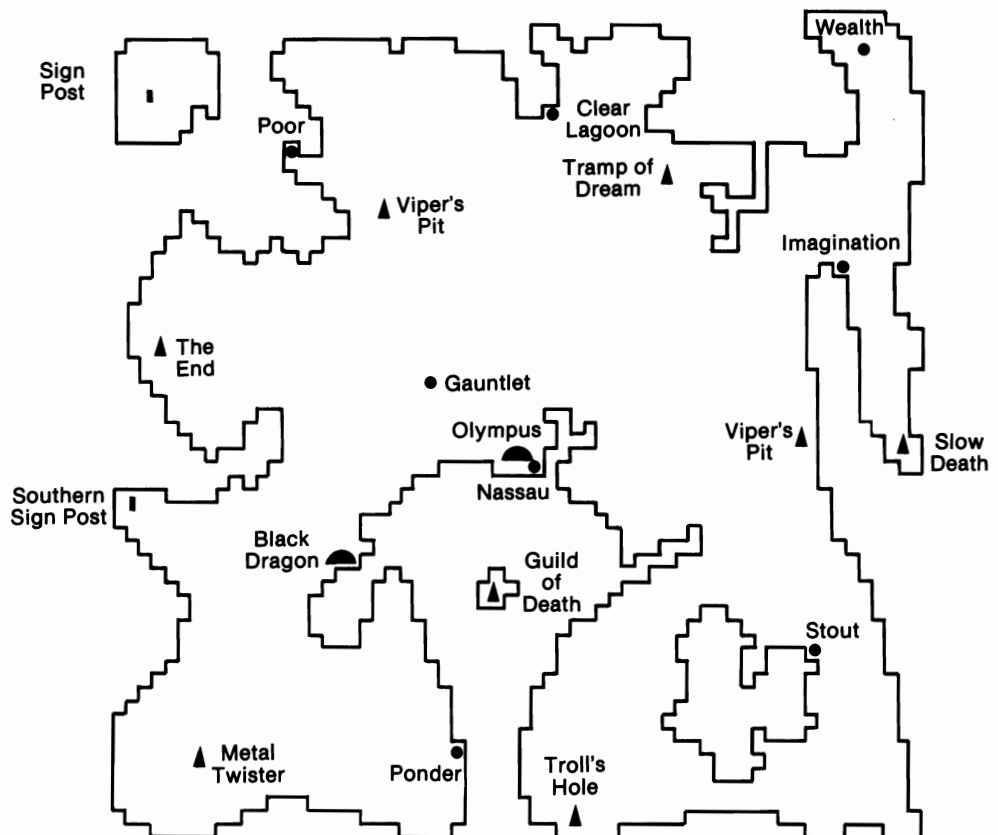

ULTIMA II

Company: Sierra On-Line Systems

Suggested Retail: \$59.95

Type: A Hi-Res fantasy with color graphics. A graphic tour-de-force.

Description:

It seems that we veterans of the earlier game were mistaken; when we finally killed Mondain, we didn't find and deal with his apprentice, Minax. Now that she has come of age, she possesses even more power than her predecessor. So, too, does *Ultima II* compared to its classy predecessor! *Ultima II's* three disk sides take you to several towers (upside down dungeons), villages, five time periods, and ten planets, in addition to the towns, castles, and dungeons that players of the original game will remember. You employ time portals, horses, ships, airplanes, and a rocket to get around.

Playability:

No specific solution exists here either, but check elsewhere for valuable tips and strategies. To achieve your goal takes many hours of searching, interrogations, and monster whomping. You really only need two objects to defeat Minax, but both require time, thought, and money. You can save the game at any point, but, as with the original, you have to go through a lengthy rebooting cycle to recall a game. Nevertheless, this game is a must.

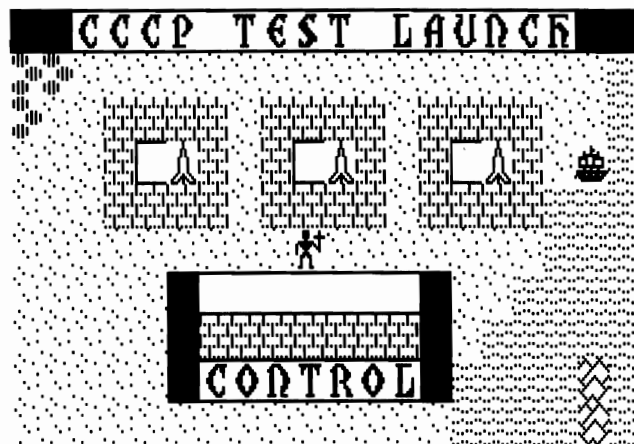
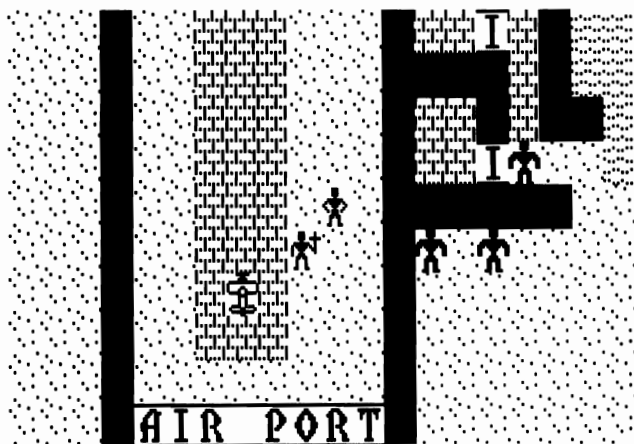

ULTIMA II

Legends

1423 BC & 1990 AD

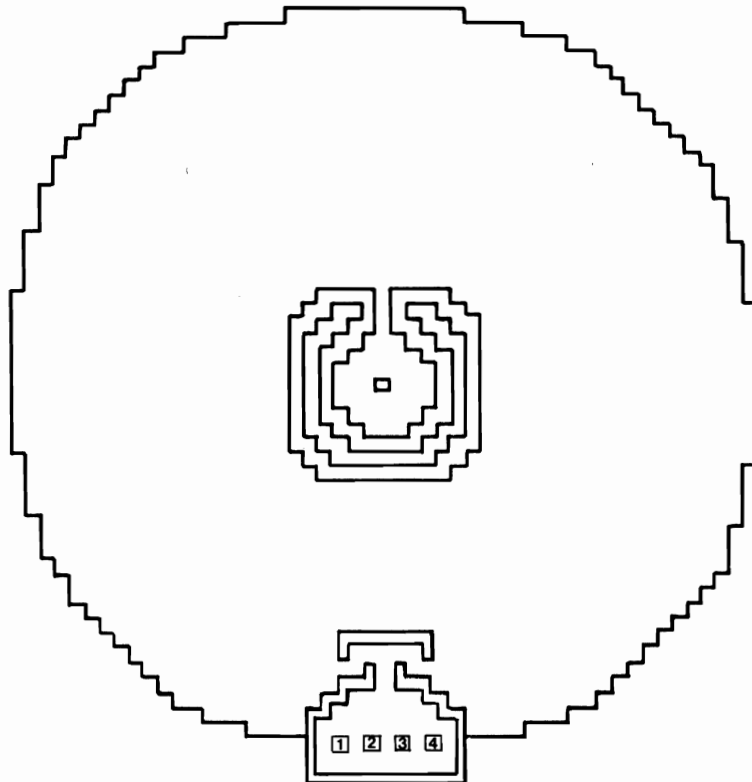
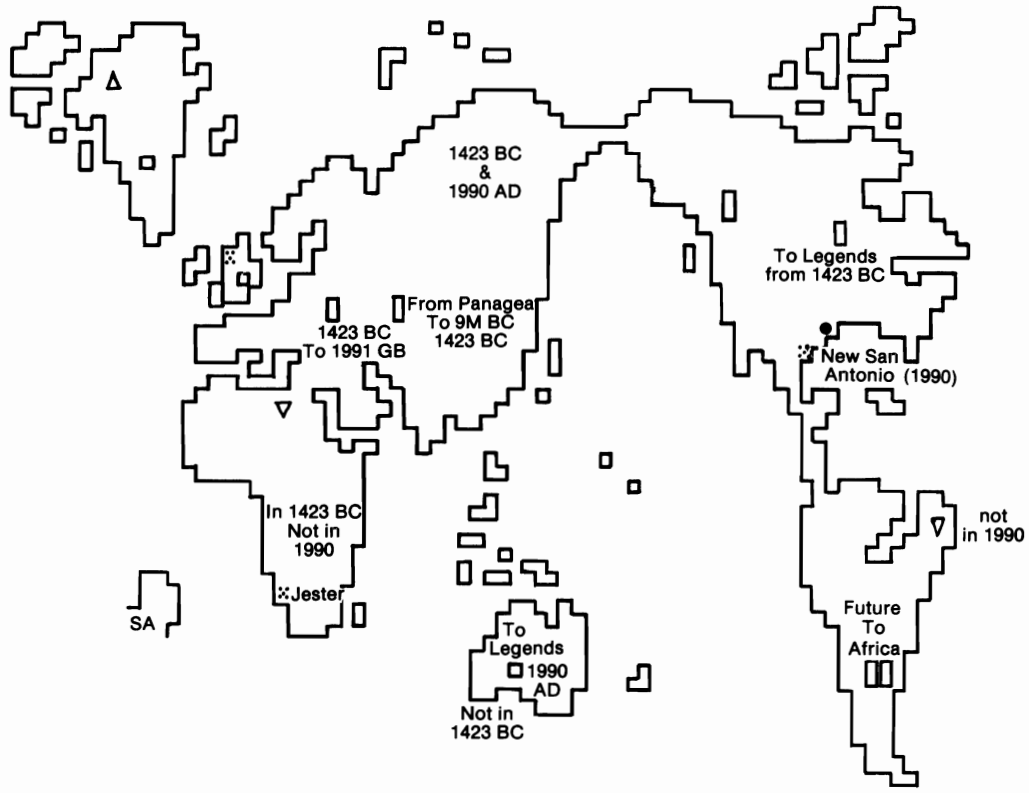

ULTIMA II

2212 AD

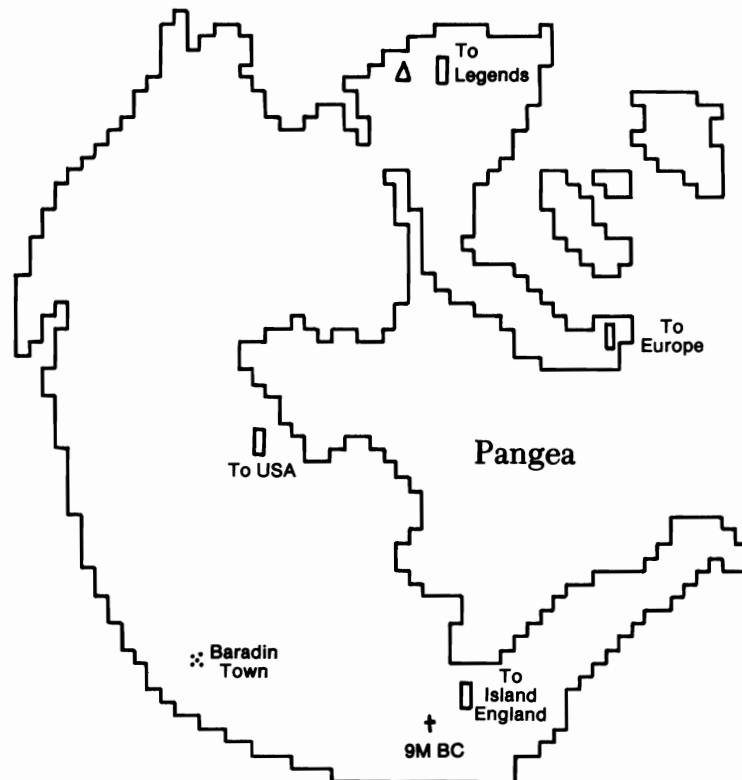
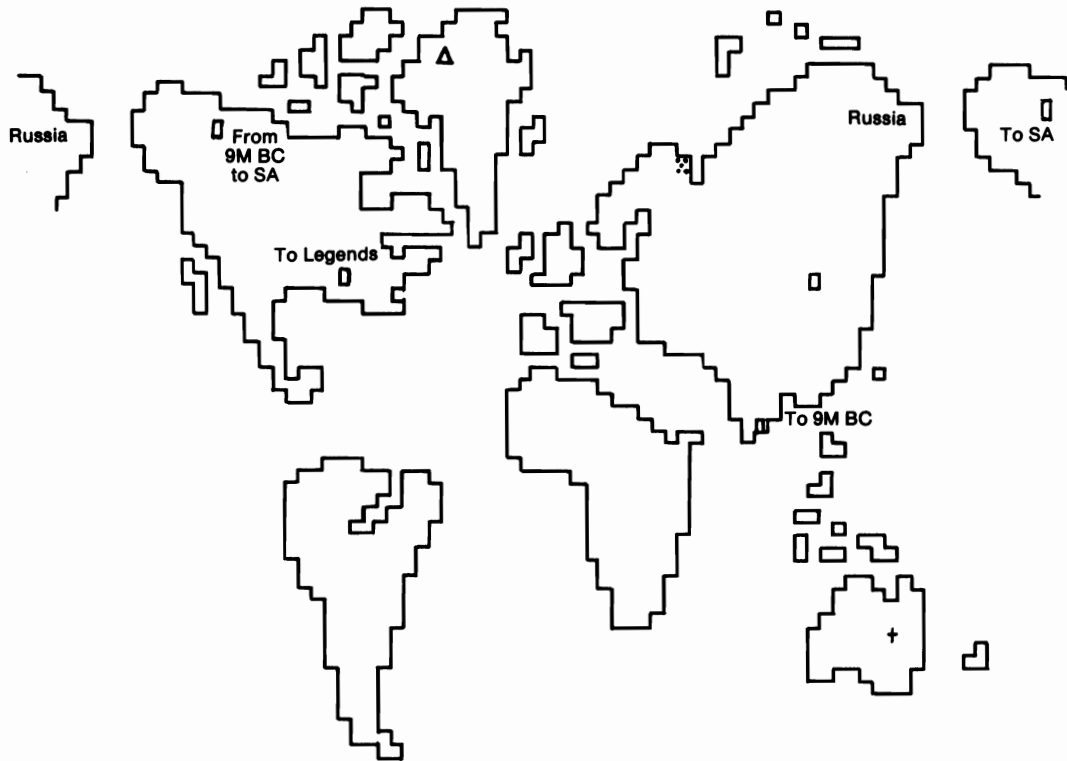

ULTIMA II

TYPICAL TOWNS AND CASTLES

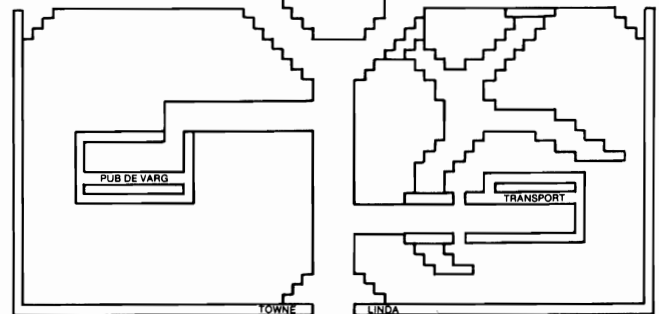
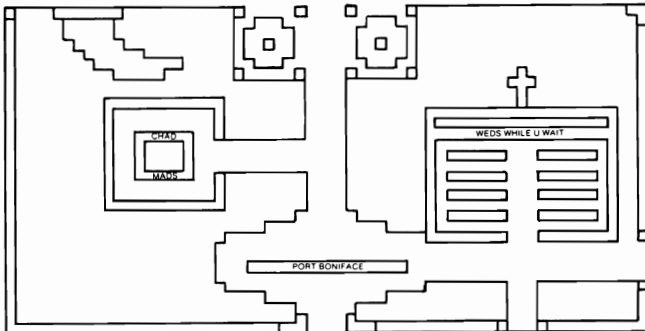
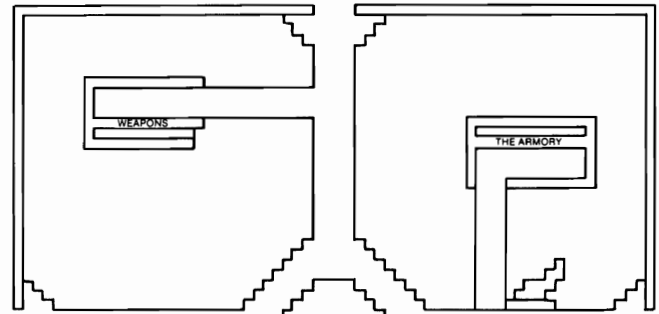
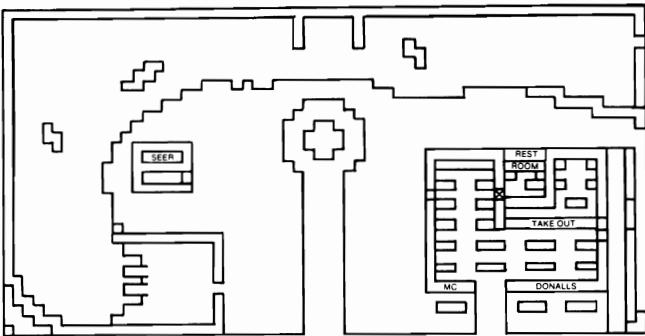
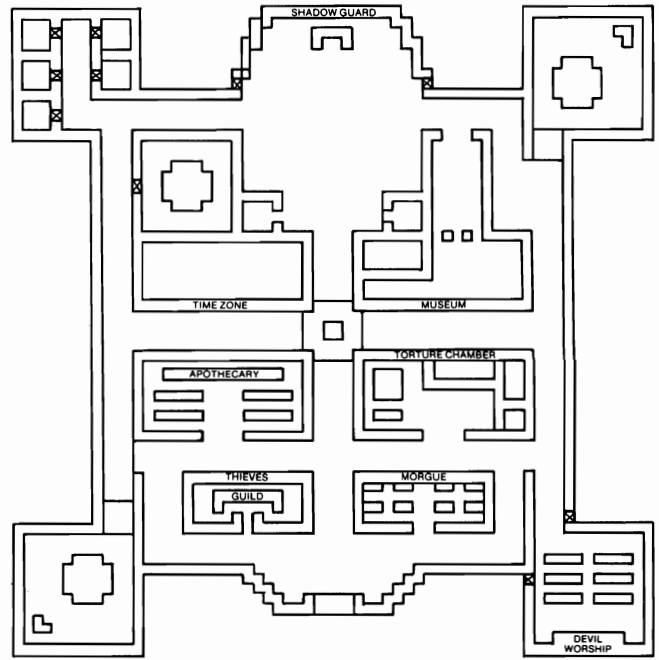
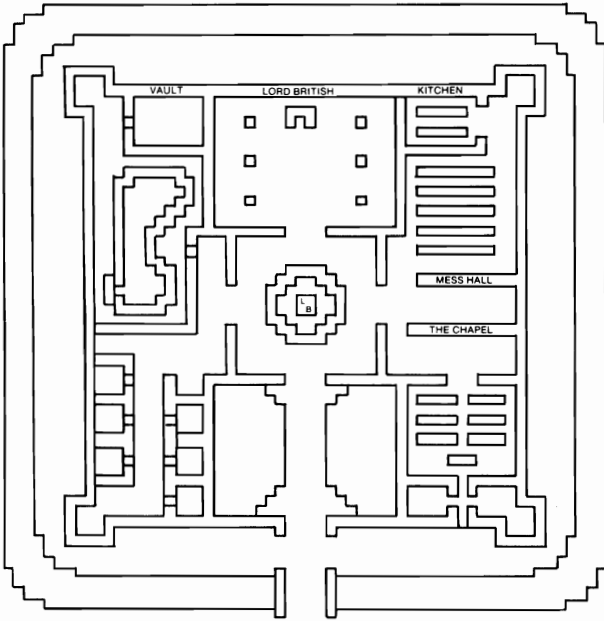

ULYSSES AND THE GOLDEN FLEECE

Company: Sierra On-Line Systems

Suggested Retail: \$32.95

Type: A Hi-Res adventure with color graphics.

Description: The King has asked that you find and return to him the fabled Golden Fleece, and even bankrolls your journey. Before you ride home to riches on Pegasus and become ordained a Level 2 adventurer, you'll have to contend with ocean storms, dragons, Neptune himself, cyclops, magic words, sirens, and a troop of skeletons bent on doing you dirt.

Playability:

Very well conceived, this game feels tight despite its size. It suffers from a poor vocabulary and lack of synonym recognition, making some already difficult puzzles even more so. A la *Cranston Manor*, it takes a lengthy reboot cycle if you get killed off, but you can call in a saved-game from the scratch disk as long as you remain alive.

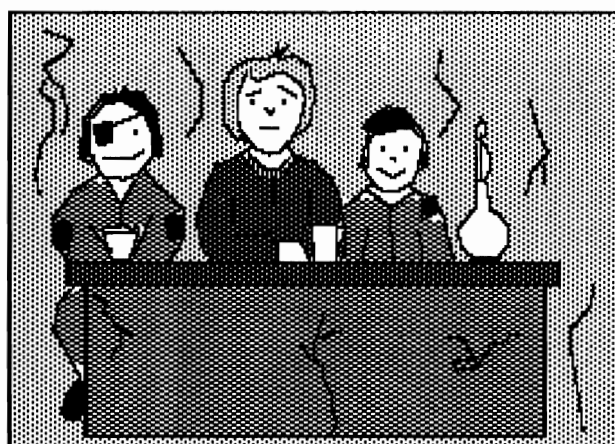
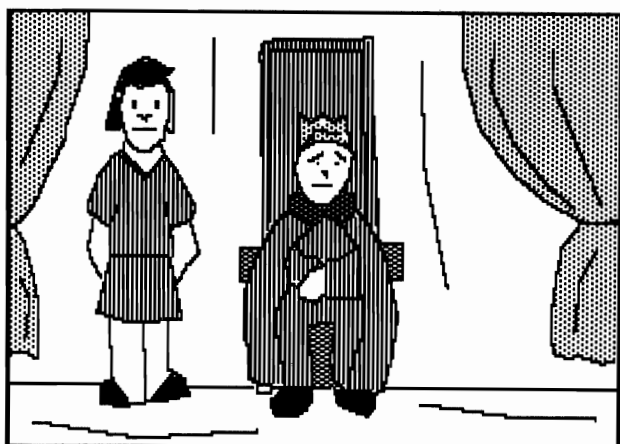
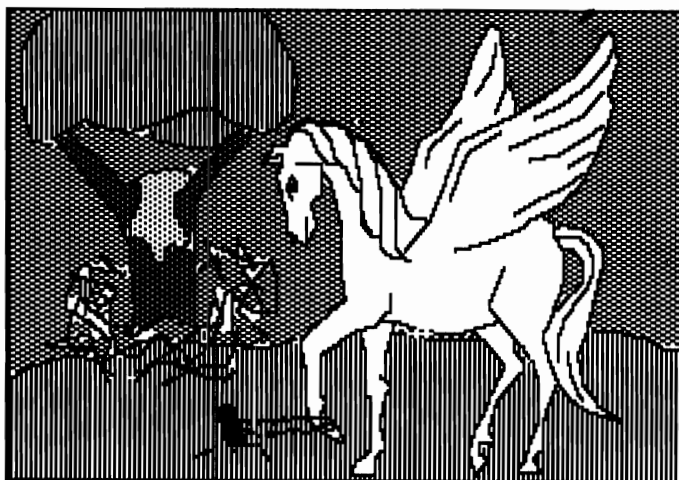

ULYSSES Part 2

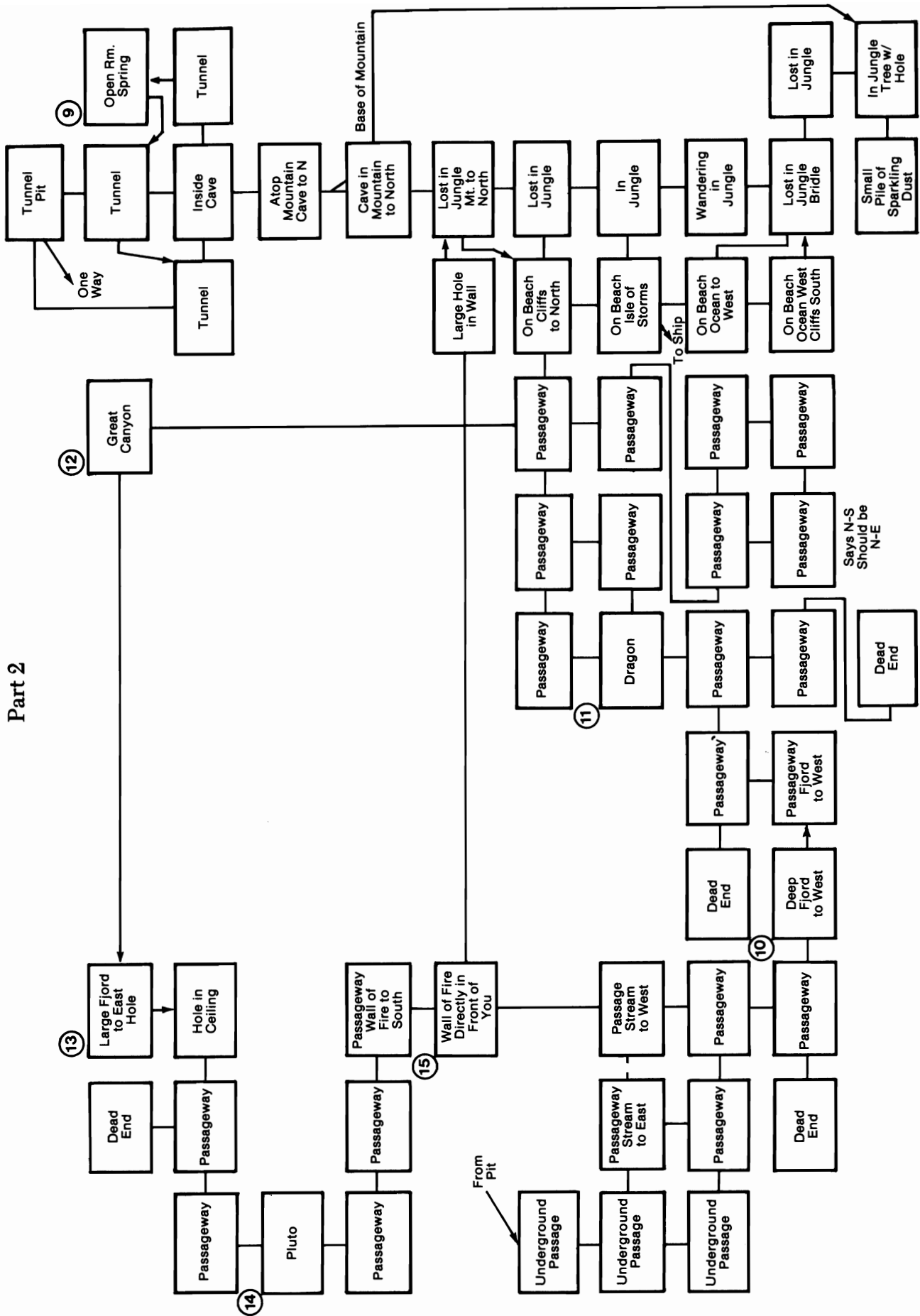

TIME ZONE
 Europe/Nottingham
 1000 AD

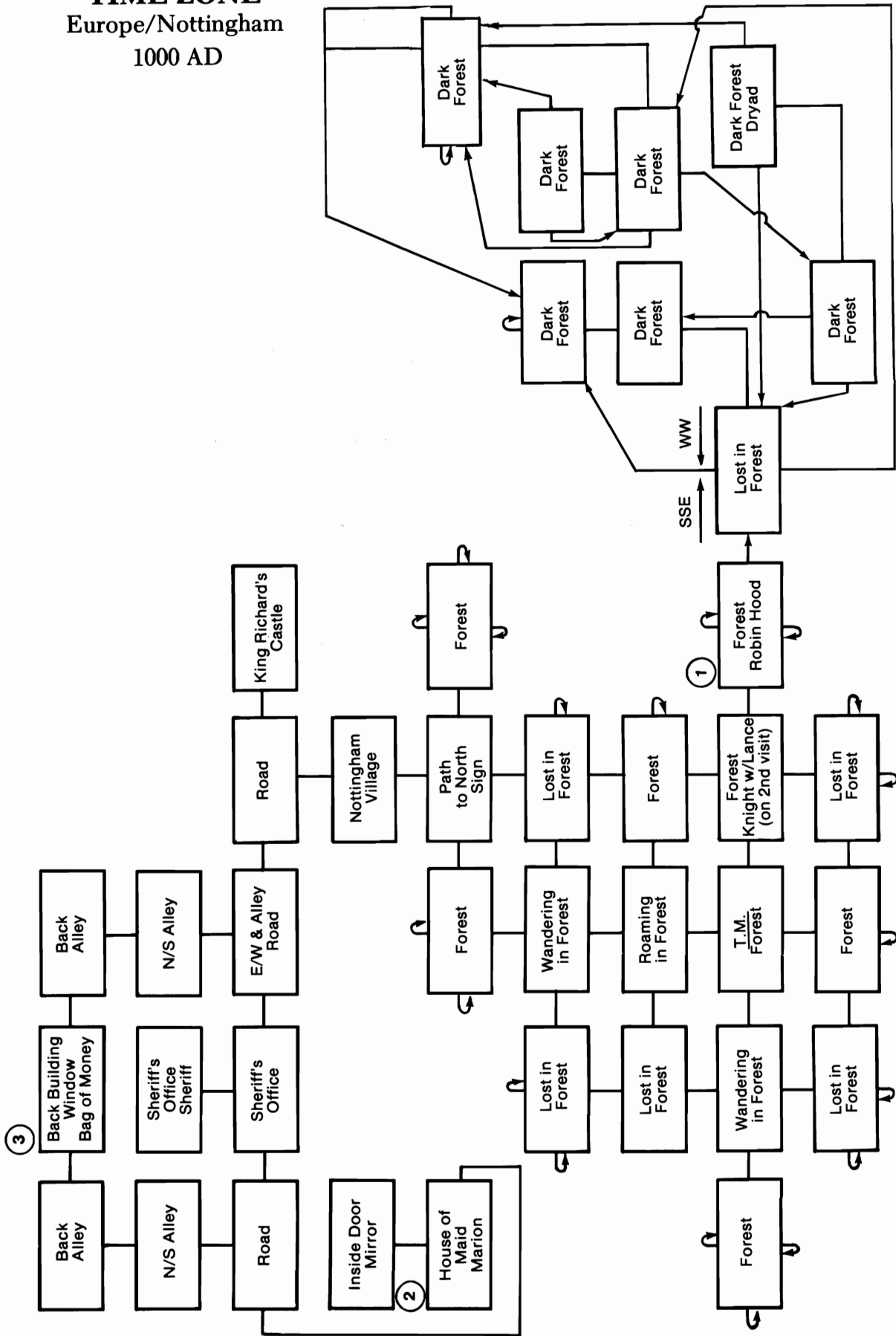

TIME ZONE SEQUENCE

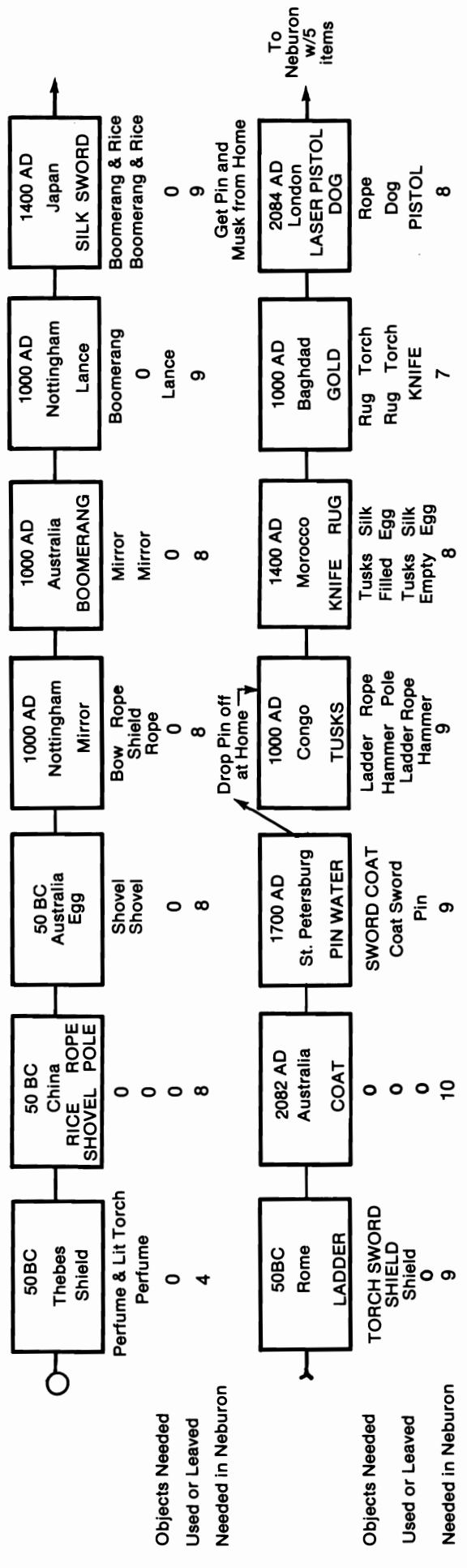
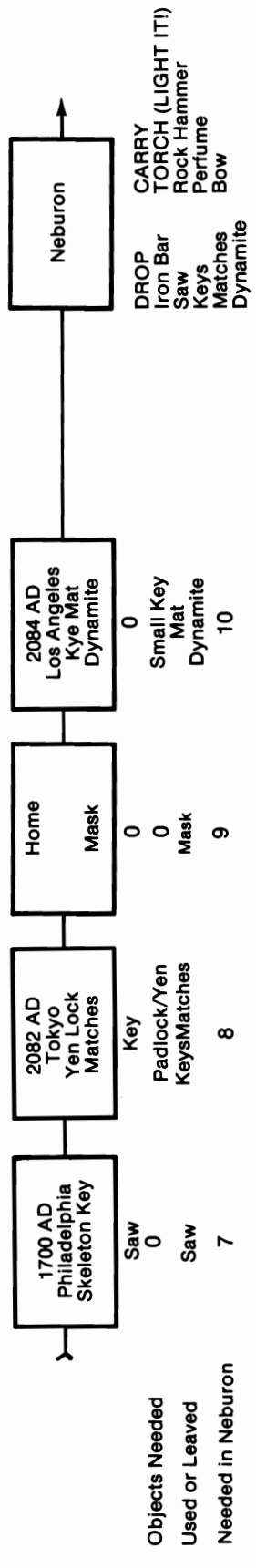
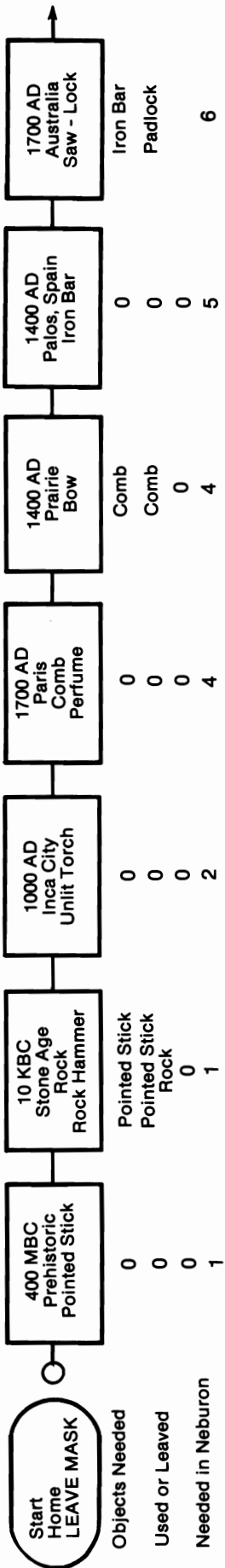

VOODOO CASTLE

Company: Adventure International

Suggested Retail: \$39.95

Type: An all-text adventure game, soon to be revised into Hi-Res form. Price also includes the *Count* and *Strange Odyssey*.

Description:

Yours is the not so simple task of removing a curse from the Count Cristo. The game takes place amid the rooms, hallways, and darkened dungeons of Voodoo Castle. You encounter a Kachina Doll, a Juju Man, a book for removing curses, and much more.

Playability:

Very well done and fast moving, with the best story line of the entire series. A few tricky spots, but eminently solvable. The two-word syntax has a limited but adequate vocabulary. The text is relatively expansive compared to the other games. It has a single easily made or recalled saved-game.

VOODOO CASTLE

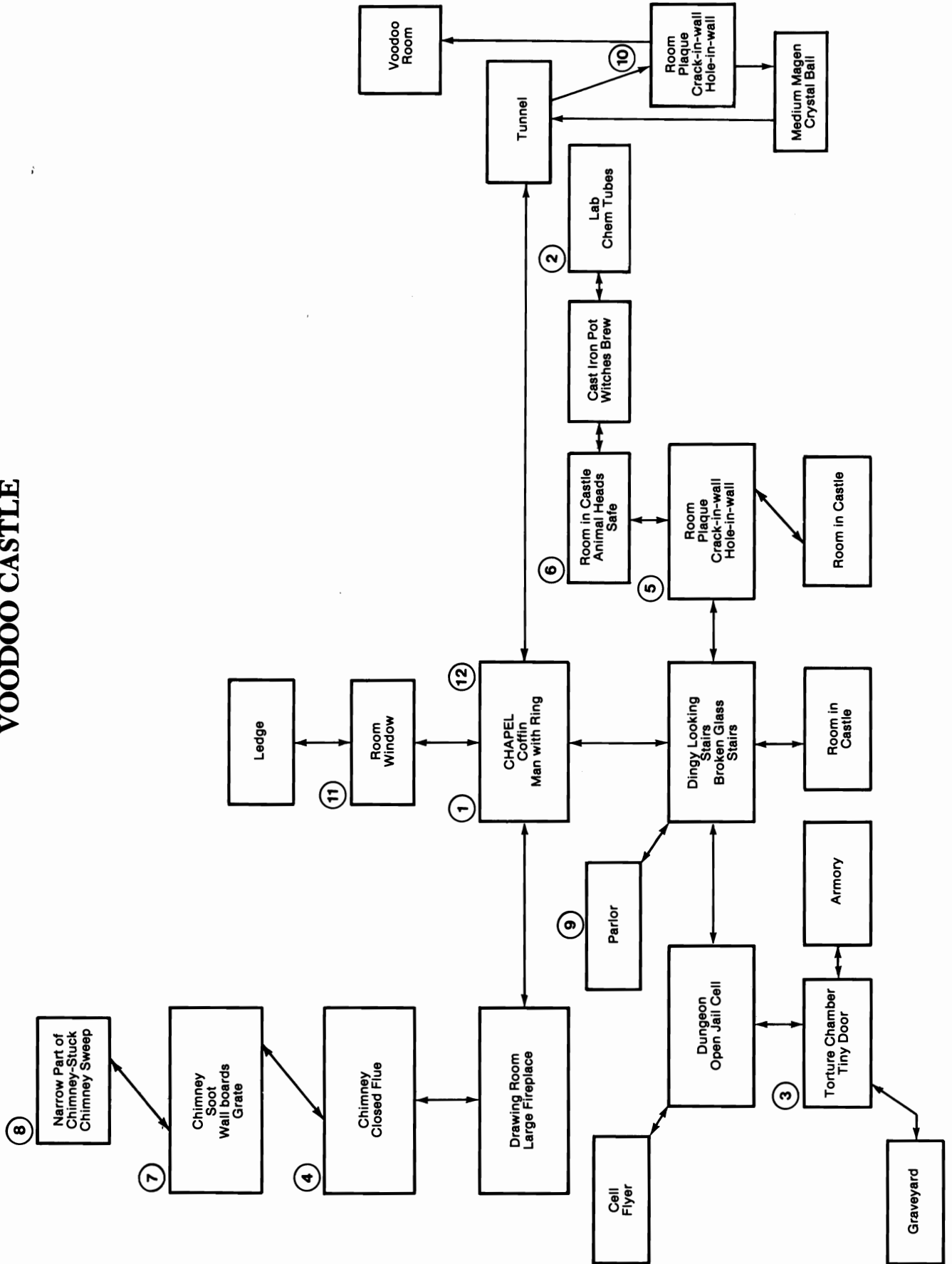

WITNESS

Company: Infocom, Inc.

Suggested Retail: \$49.95

Type: An all-text detective mystery adventure.

Description:

In the Los Angeles of 1938, the wife of a noted millionaire businessman has committed suicide. You are the police detective assigned to investigate his concern over threats made on his life. There must have been something to them, for before your very eyes and in the midst of your investigation, he is shot to death. Whodunit—the Butler, the Daughter, or the wife's lover—and precisely how? It soon becomes obvious that you cannot mount a good case against several of them.

Playability:

Don't try to compare this one to *Deadline*. It's much easier, almost too easy, as things quickly fall into place as soon as you examine certain key objects. Alternate endings exist, but only one is correct. Imaginative and reasonably interactive puzzles, but just too few of them. OK for neophytes, but not too much here for advanced adventurers. The parser and save-game capability, as always, are great but the vocabulary is a bit weak for an Infocom game.



WITNESS

Sorry, no answer numbers this time around as it would be too revealing. Read the answers in sequence when you're stuck. No fair to read more than one at a time!

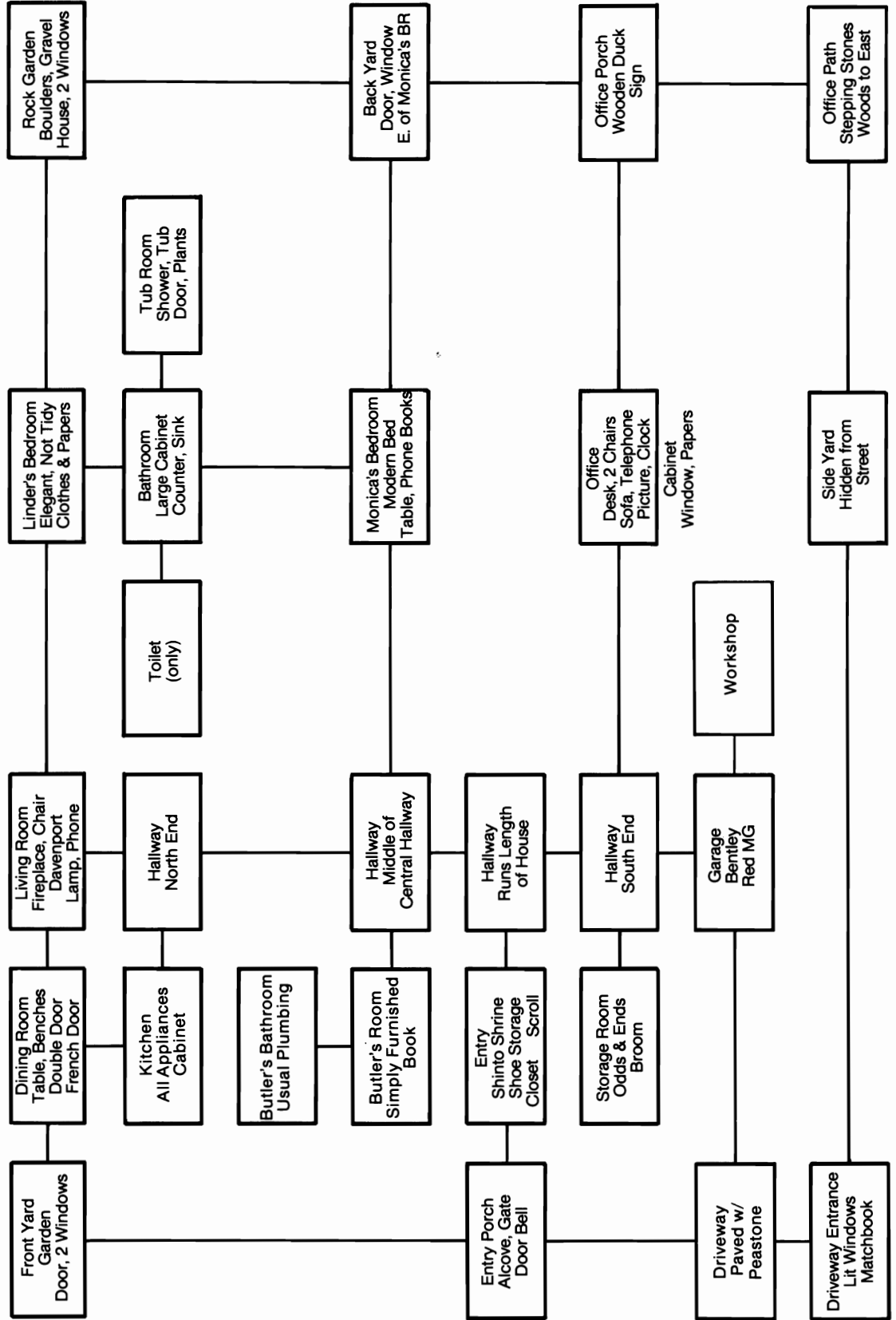

WIZARD AND THE PRINCESS

Company: Sierra On-Line Systems

Suggested Retail: \$32.95

Type: Hi-Res adventure with color graphics.

Description:

Here you find and return a Princess, bewitched by a wicked wizard and spirited away to his remote Castle. It's tough to get started. You must pass a coiled snake, but scorpions cover most rocks you might kill it with. After that you face a desert, a wide canyon, a wooded beach area, two tropical islands, a rickety bridge, a thieving gnome, a pirate, a giant, a wandering merchant, a maze, and a magical castle.

Playability:

The second of the Hi-Res adventures. Despite its relative age, it's still a winner. The game is disk intensive and slightly on the slow side, but straightforward and easy to play. Both kids and adults will find *Wizard and the Princess* very entertaining and challenging.

THE WIZARD & THE PRINCESS

Part 2

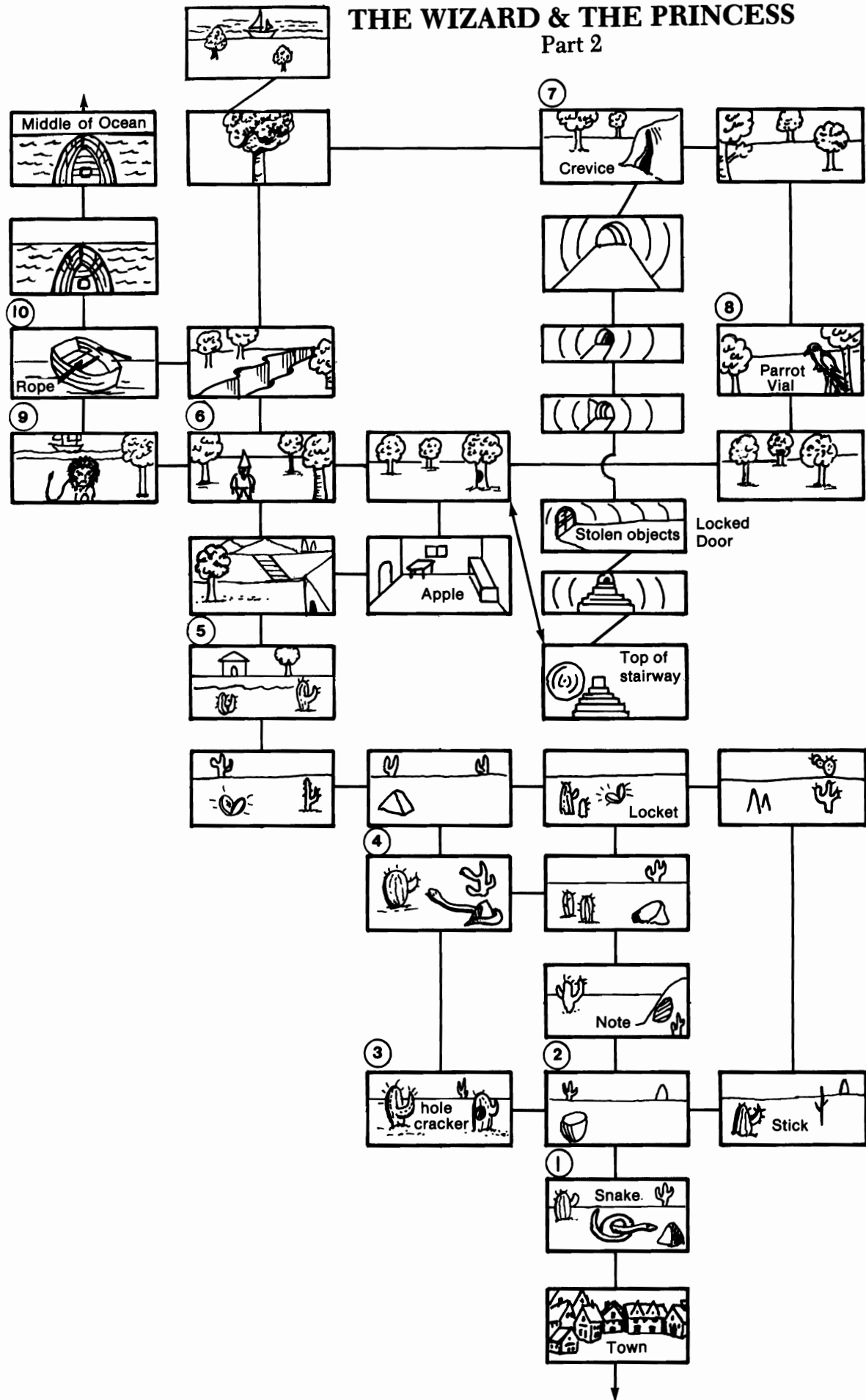

THE WIZARD & THE PRINCESS

Part 3

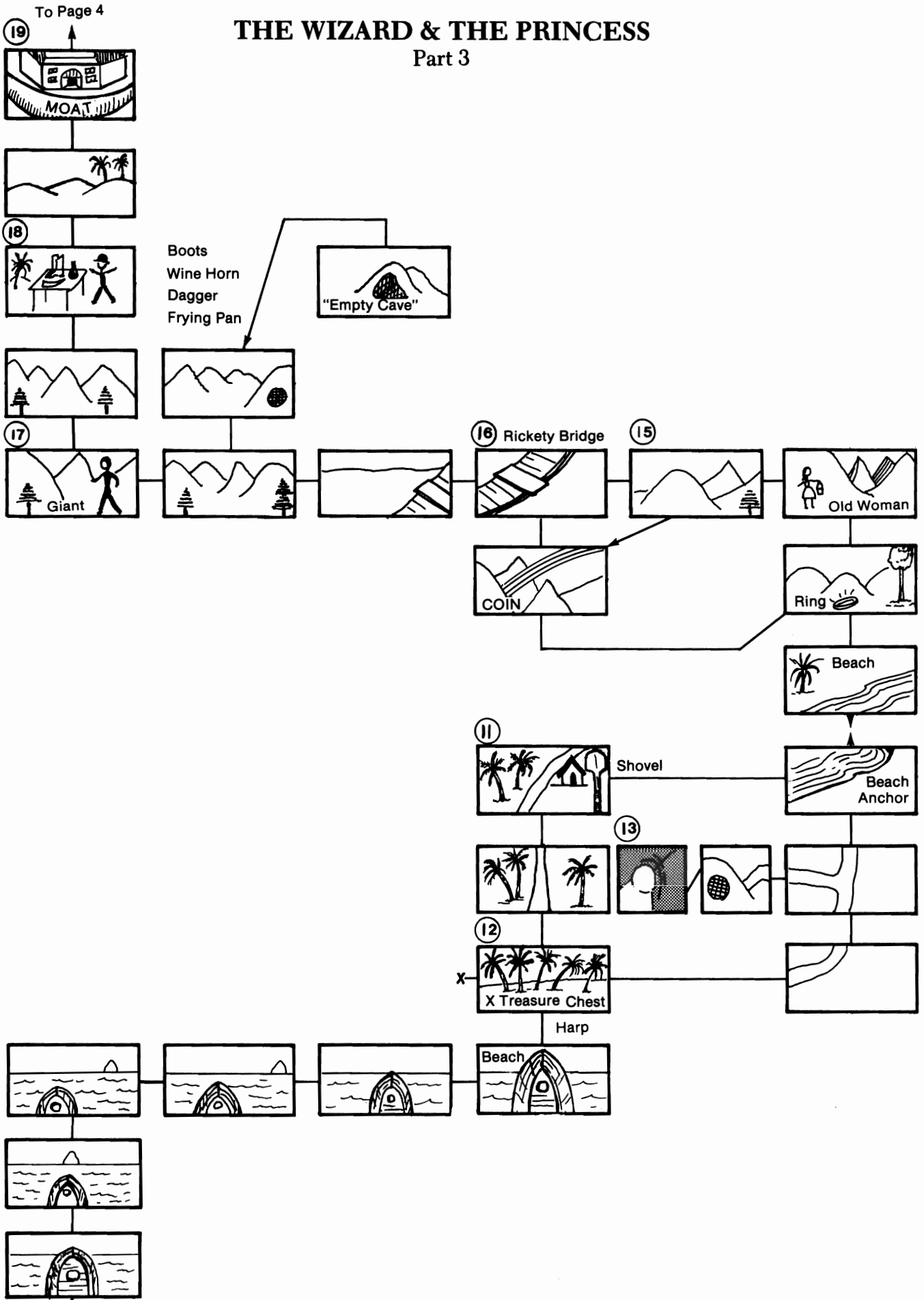

THE WIZARD & THE PRINCESS

Part 4

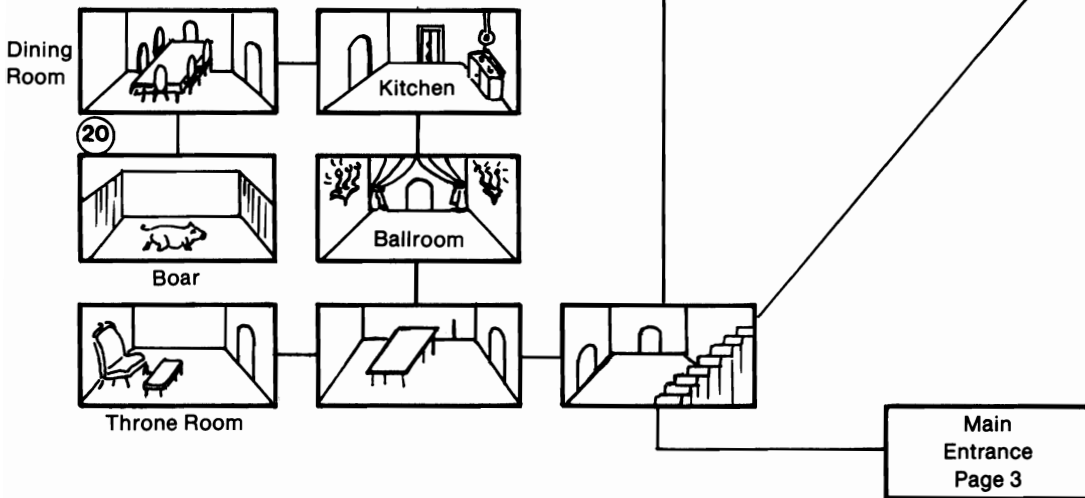
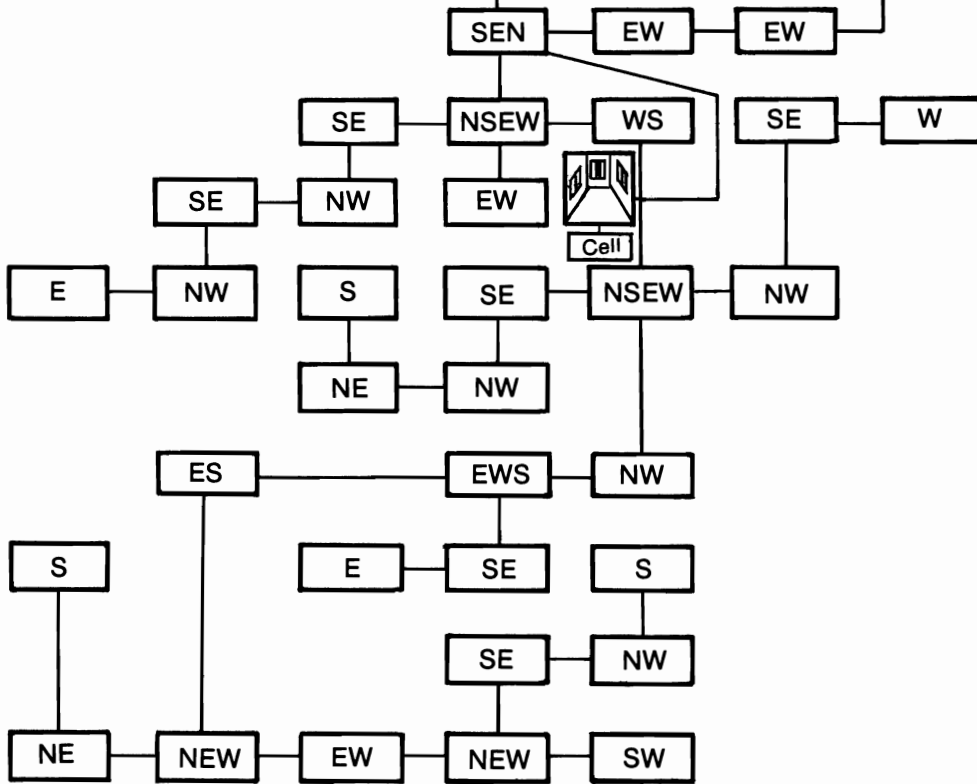
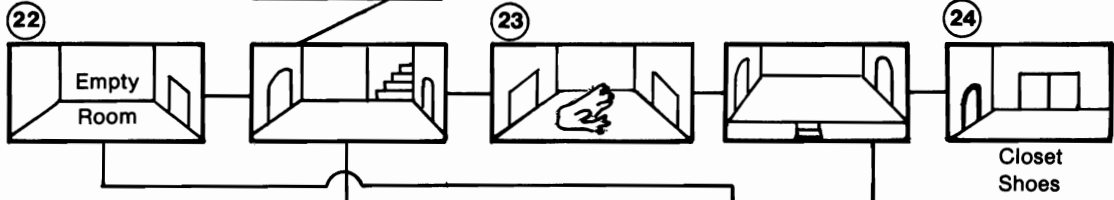
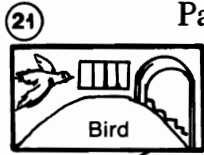

WIZARDRY

Company: Sir-Tech Software, Inc.

Suggested Retail: \$49.95

Type: Hi-Res fantasy adventure.

Description:

The ultimate maze type of fantasy adventure game. Take six characters into the ten dungeon levels and seek your fame and fortune. You create each character out of five races, three alignments, and eight classes, and each has its own unique capabilities. The game provides nifty but repetitive graphics, and not much in the way of text. You have no puzzles as such, but must find a number of objects so you can proceed. As such, *Wizardry* requires complete exploration of each level.

Playability:

This game demands careful and detailed mapping and knowledge of your location at any time. No solution occurs as such, hence, no verbal solution is provided here. It's difficult to get started with a set of characters that can survive for long, but once you get a reasonable set of spell capabilities, matters change for the better. This very long and involved game which unfortunately cannot be saved in the midst of a deep, dark dungeon.

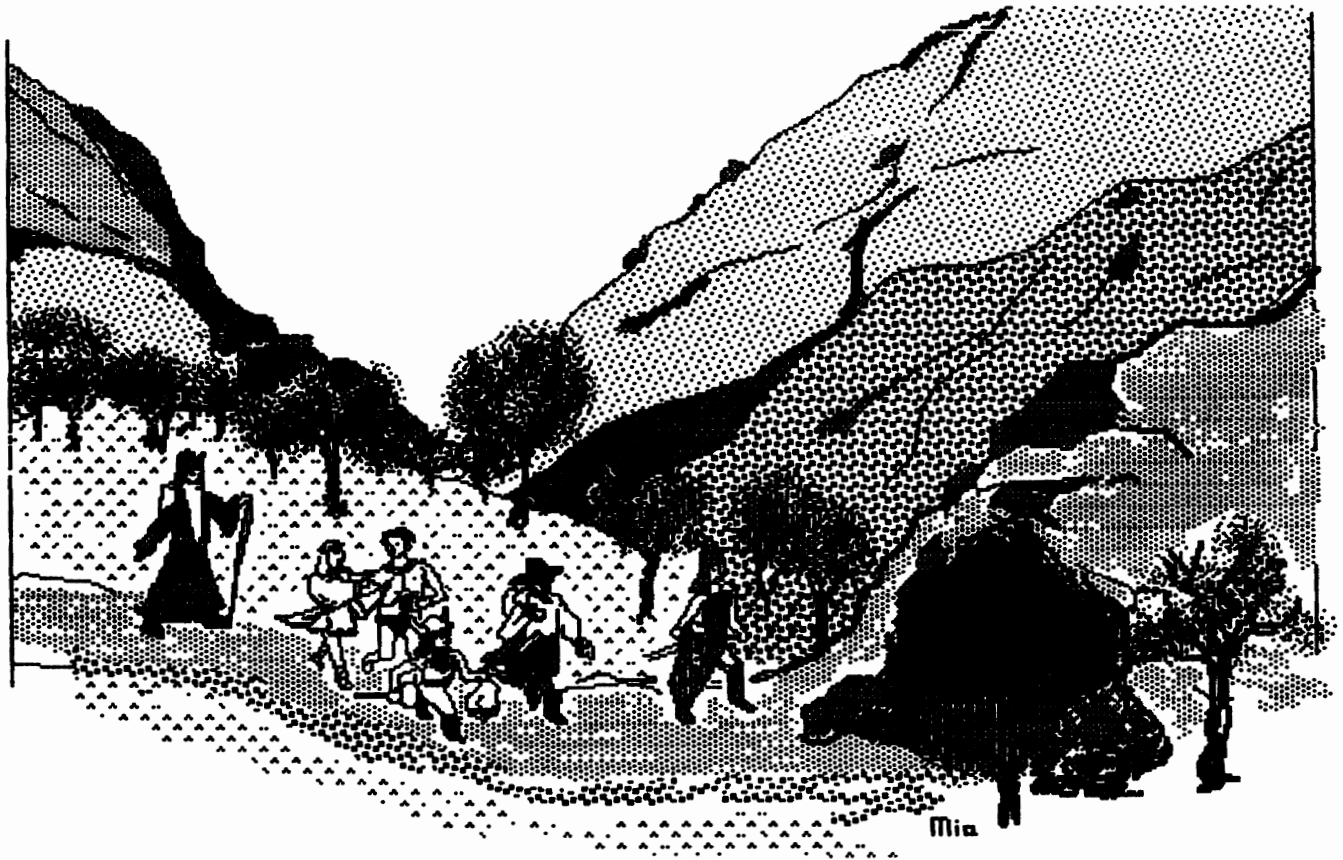

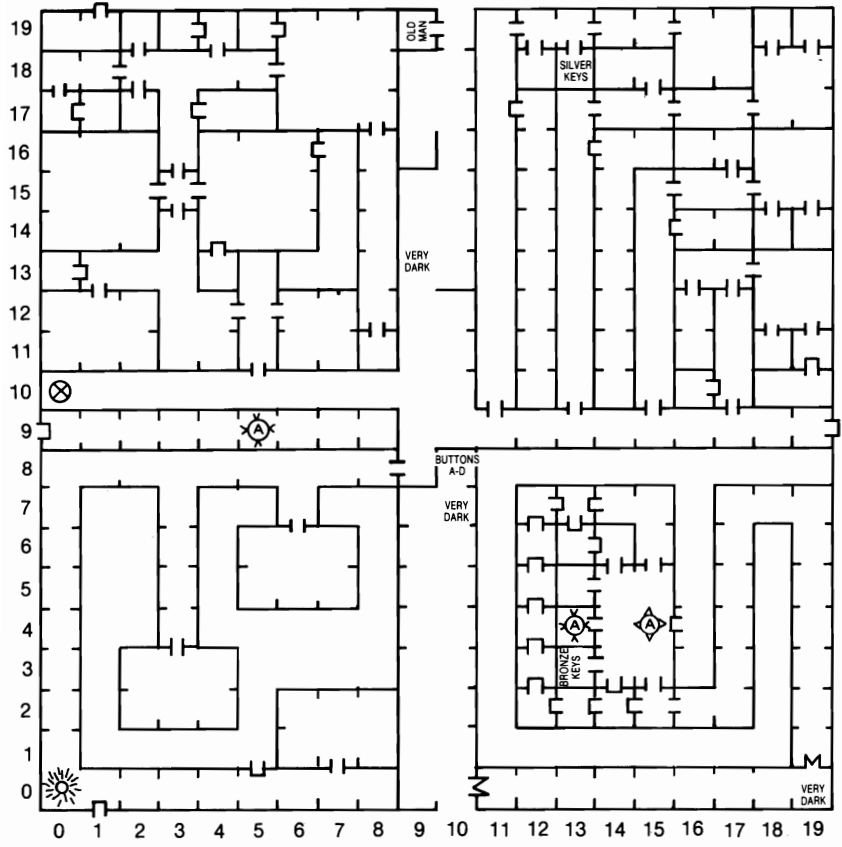

WIZARDRY
(A) Regular Elevation (1st Level)

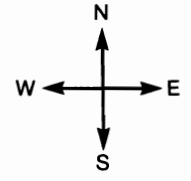

- ⊗ DOWN STAIRS
- ⊙ UP STAIRS
- ┌ ONE WAY DOOR
- └ ONE WAY PASS.
- ⊕ SPINNER
- N.D. NO DOOR
- ☼ TELEPORT
- FROM TO

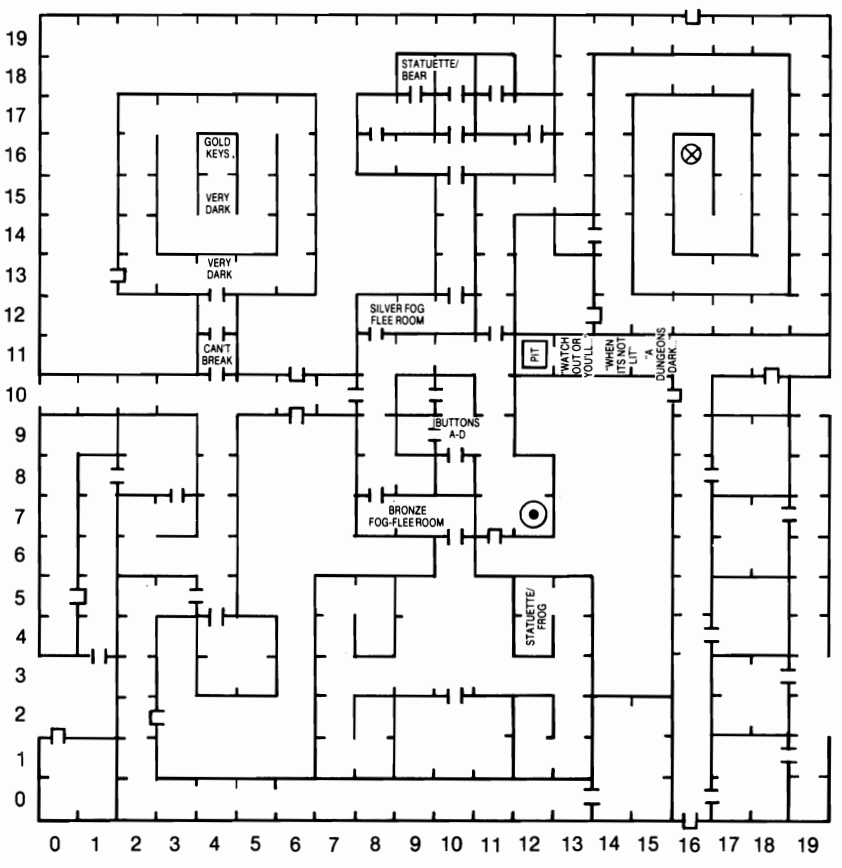

WIZARDRY
(B) Regular Elevation (2nd Level)

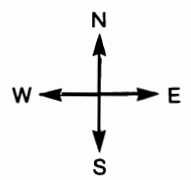

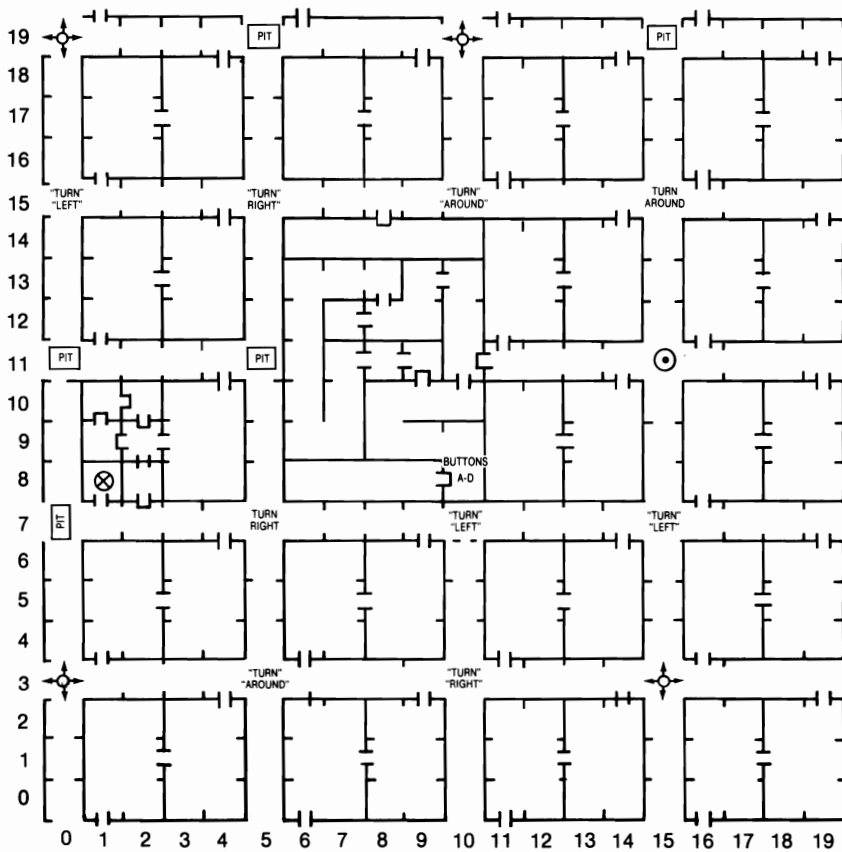

WIZARDRY
(C) Regular Elevation (3rd Level)

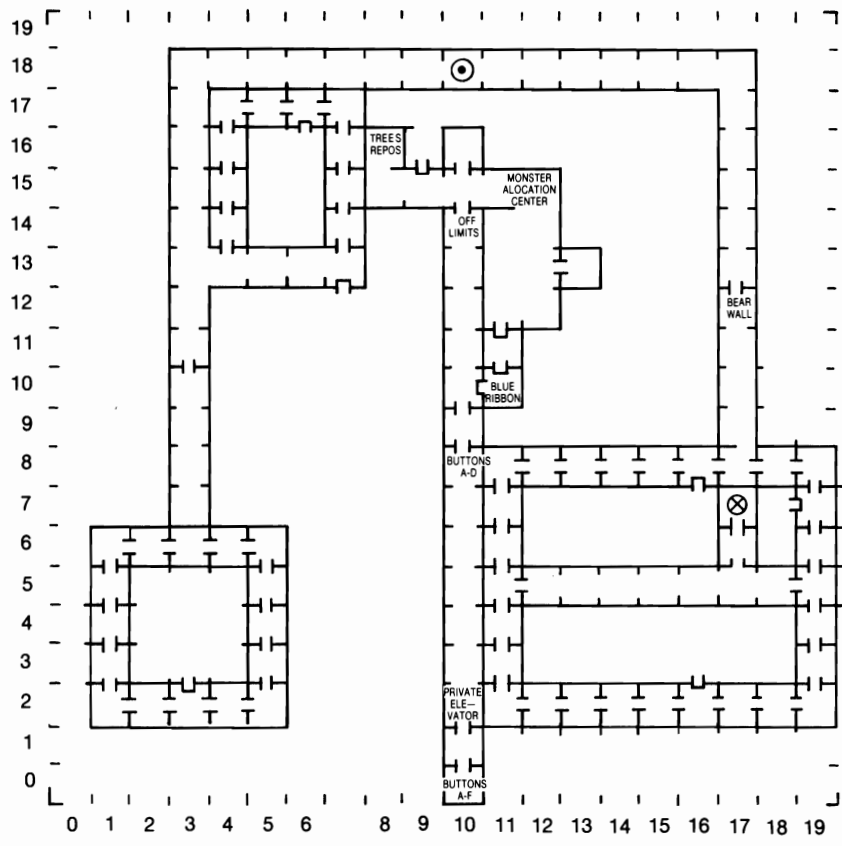
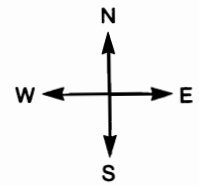

WIZARDRY
(D) Regular Elevation (A)
Special Elevation (4th Level)

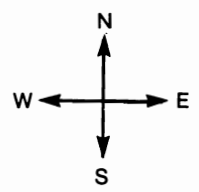

WIZARDRY
(B) Special Elevation (5th Level)

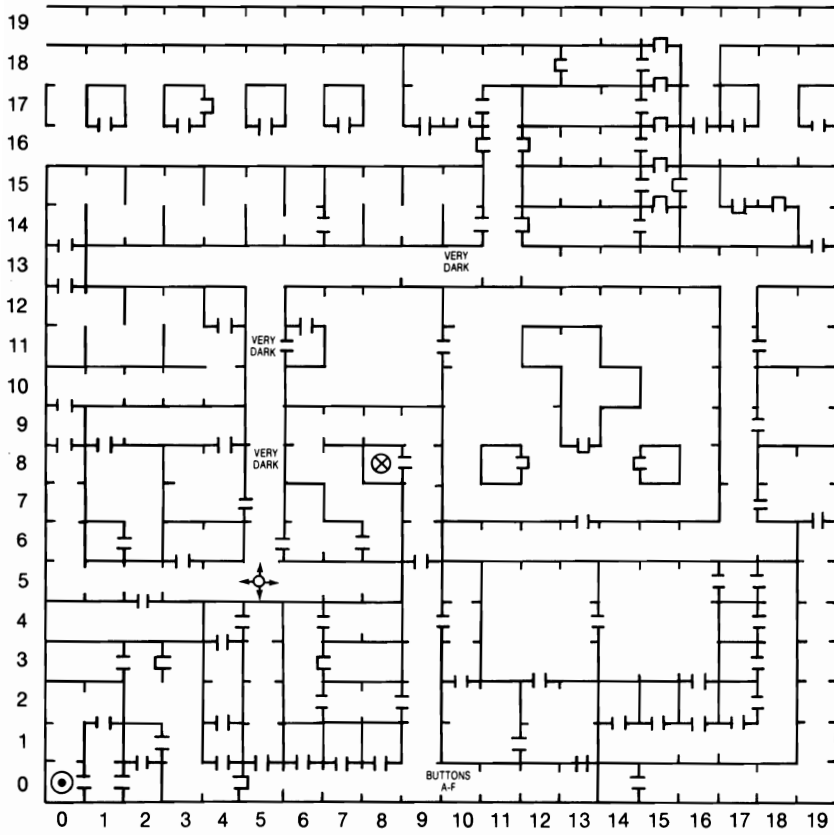
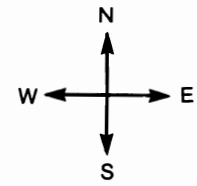

WIZARDRY
(C) Special Elevation (6th Level)

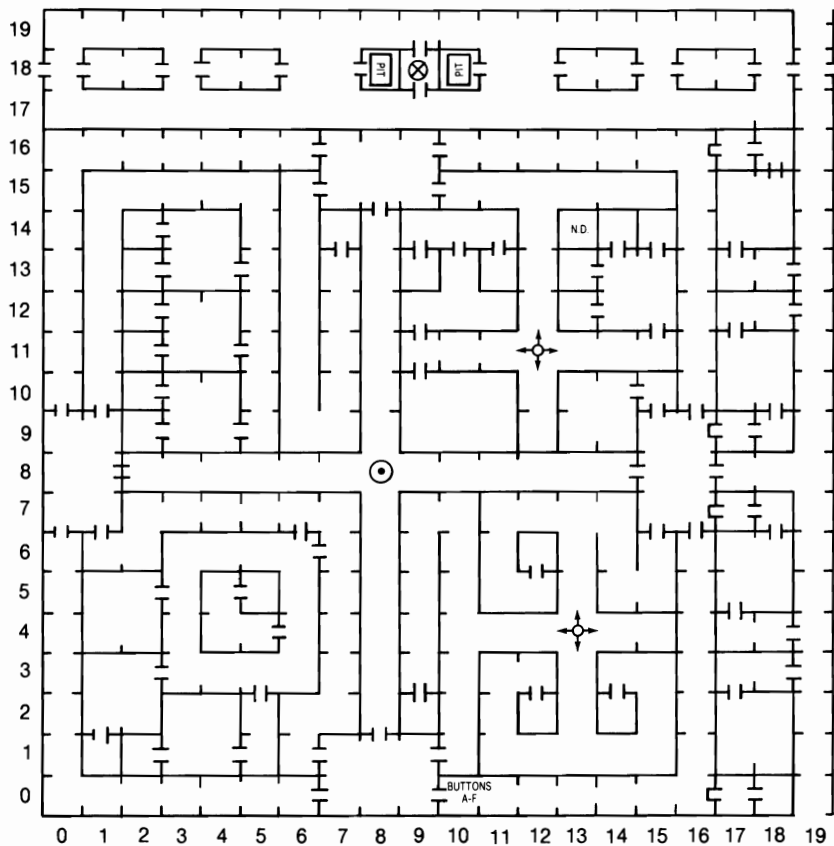
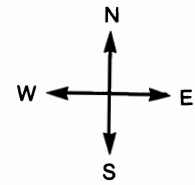

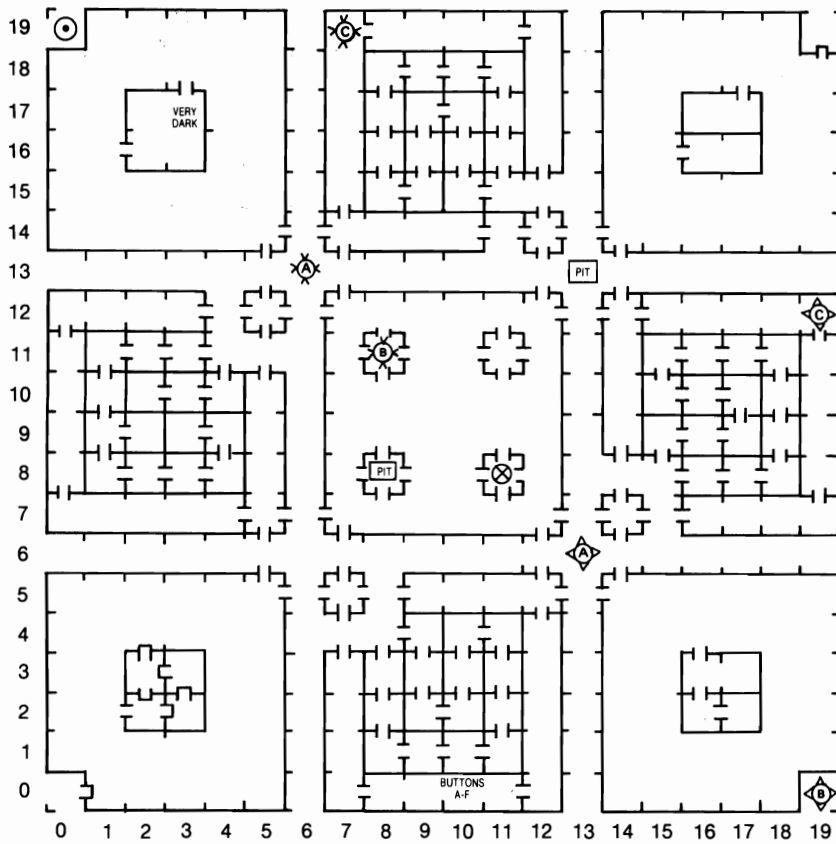

WIZARDRY
(D) Special Elevation (7th Level)

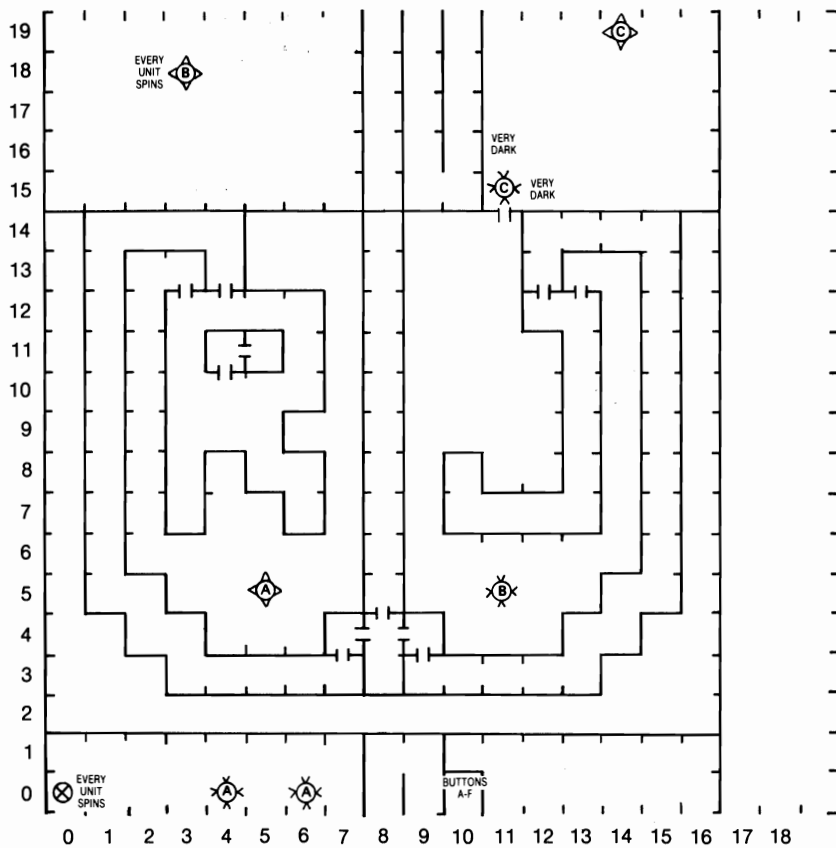
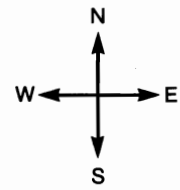

WIZARDRY
(F) Special Elevation (8th Level)

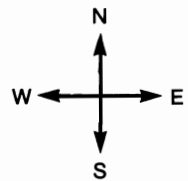

ZORK I

Company: Infocom, Inc.

Suggested Retail: \$39.95

Type: An all-text adventure.

Description:

Zork I is simply the best selling adventure of all time. You start near a deserted house, over a huge and wondrous underground cavern. Nineteen treasures await discovery, but they are well-hidden by the expansive and novel-like text descriptions of the dam, coal mine, lake, chapel, and even the Gates of Hell. Along the way, you will meet and must deal with the likes of a testy Troll, an audacious Thief, and a hungry Cyclops.

Playability:

Very interactive and challenging puzzles. A superb word parser which anticipates just about any response supports the multiple word parser. The save-game capability, usable at any time, supports two drives. Originally written on a mainframe, *Zork I* faithfully represents the first third of that game. When you tackle this one, you are in for a lot of fun.



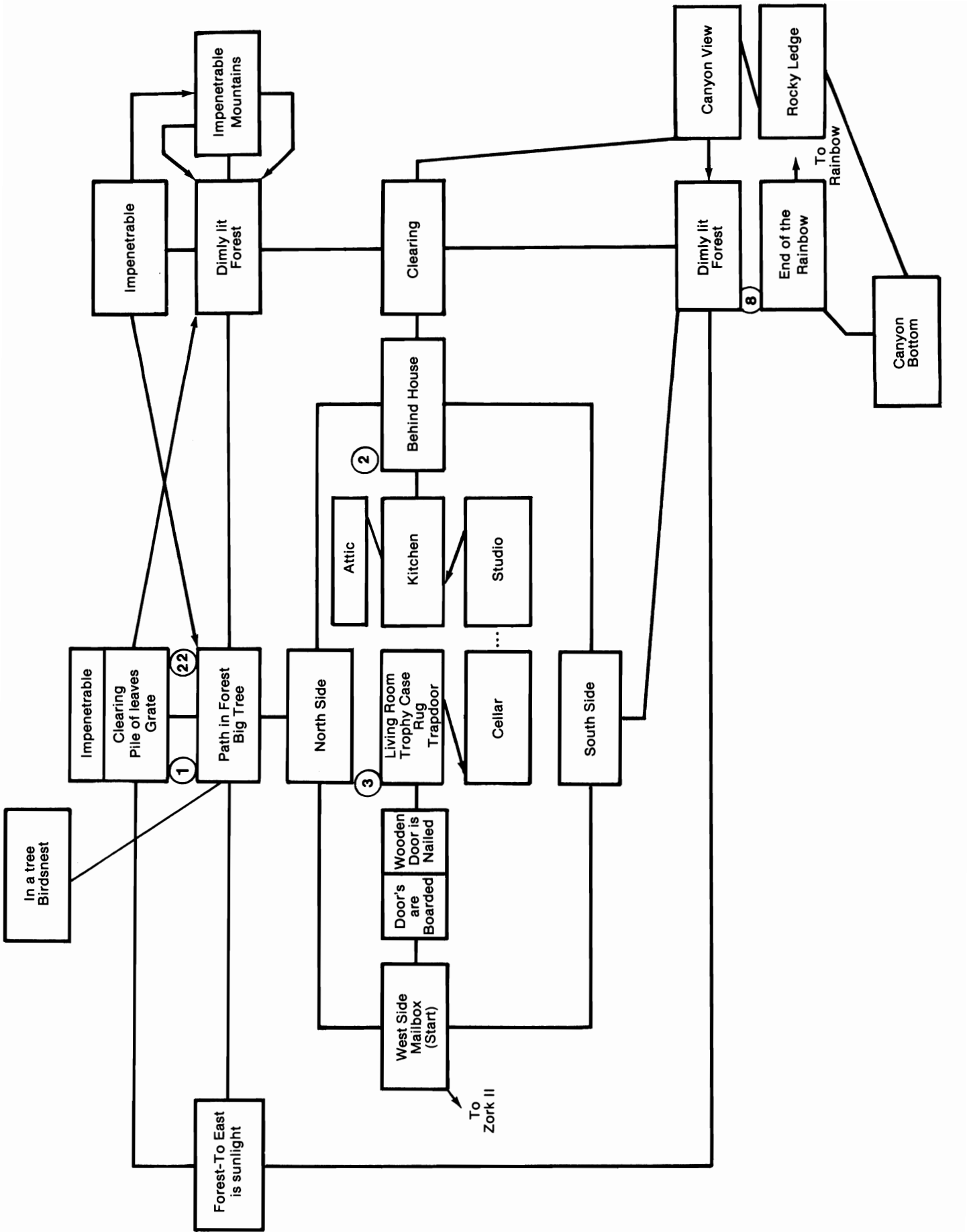

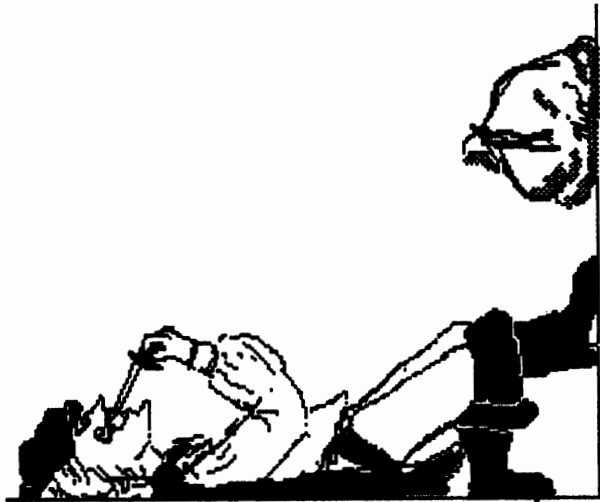

ZORK I

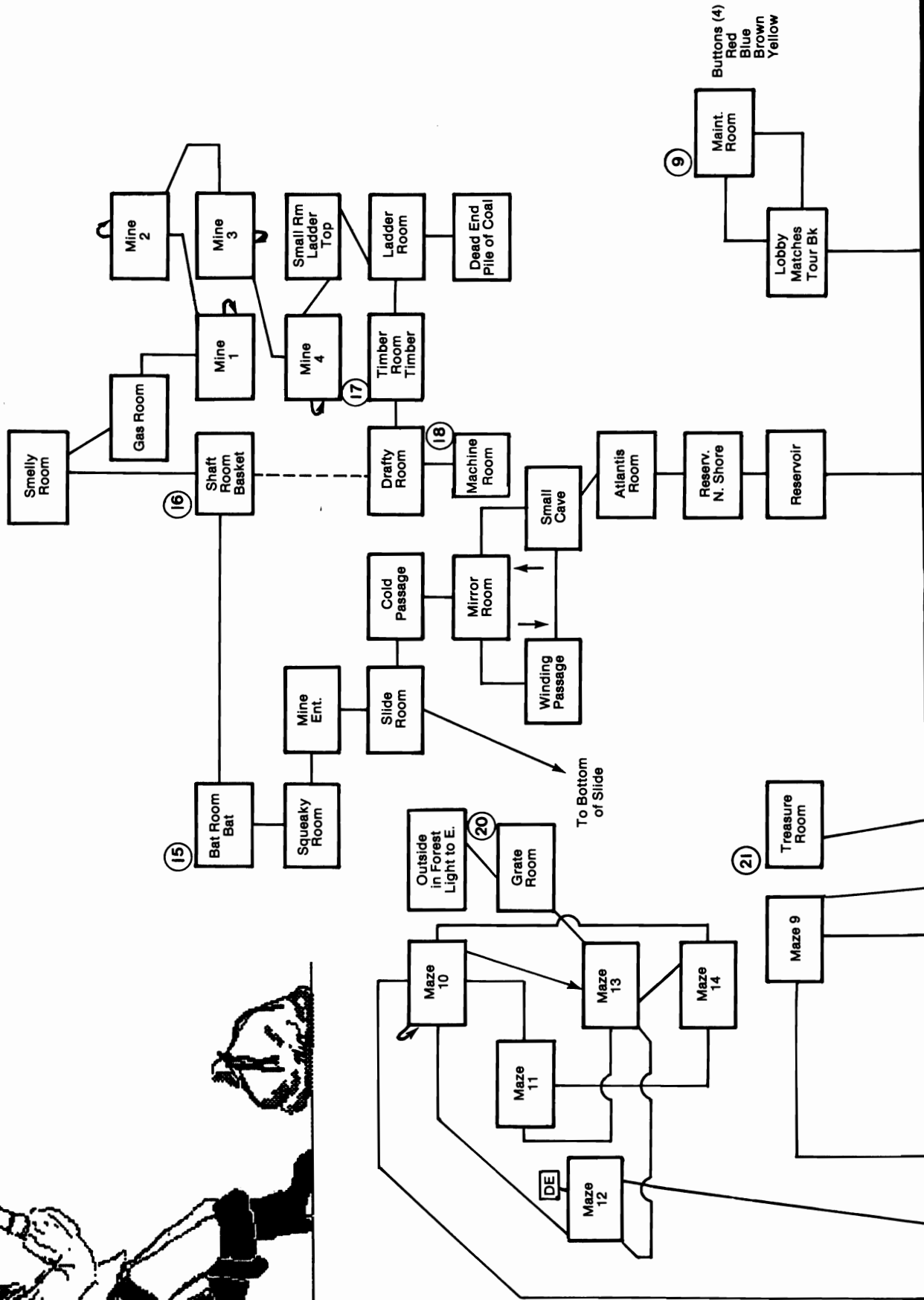

Buttons (4)
Red
Blue
Brown
Yellow

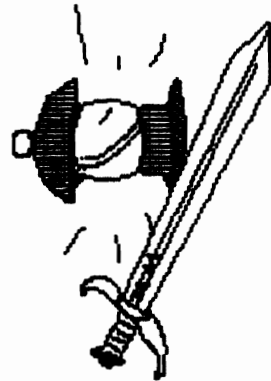
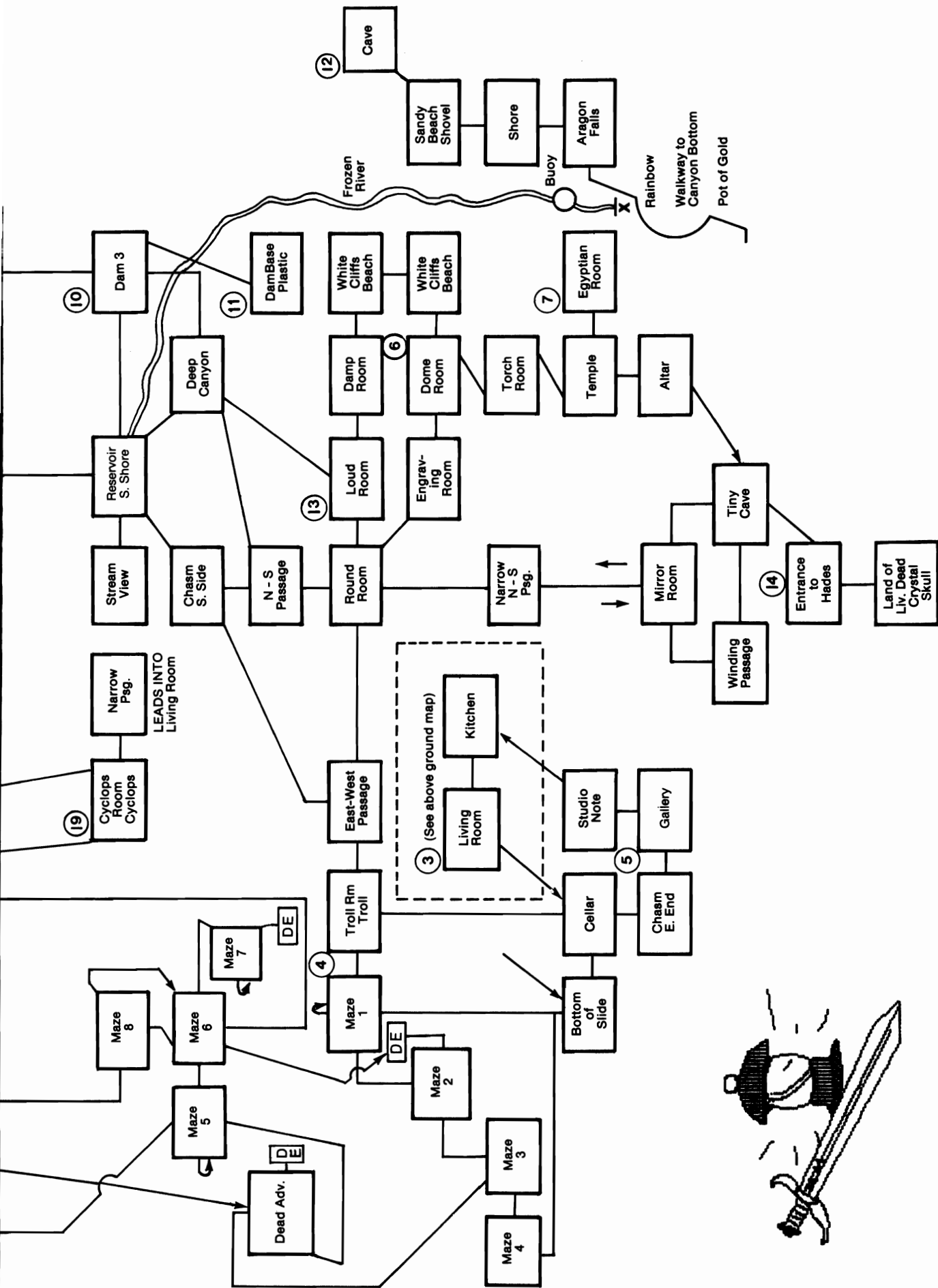

ZORK II

Company: Infocom, Inc.

Suggested Retail: \$39.95

Type: An all-text adventure.

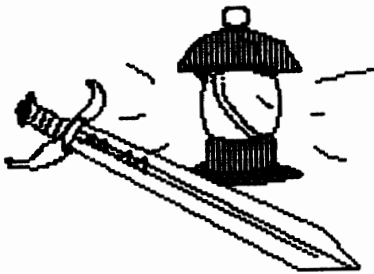
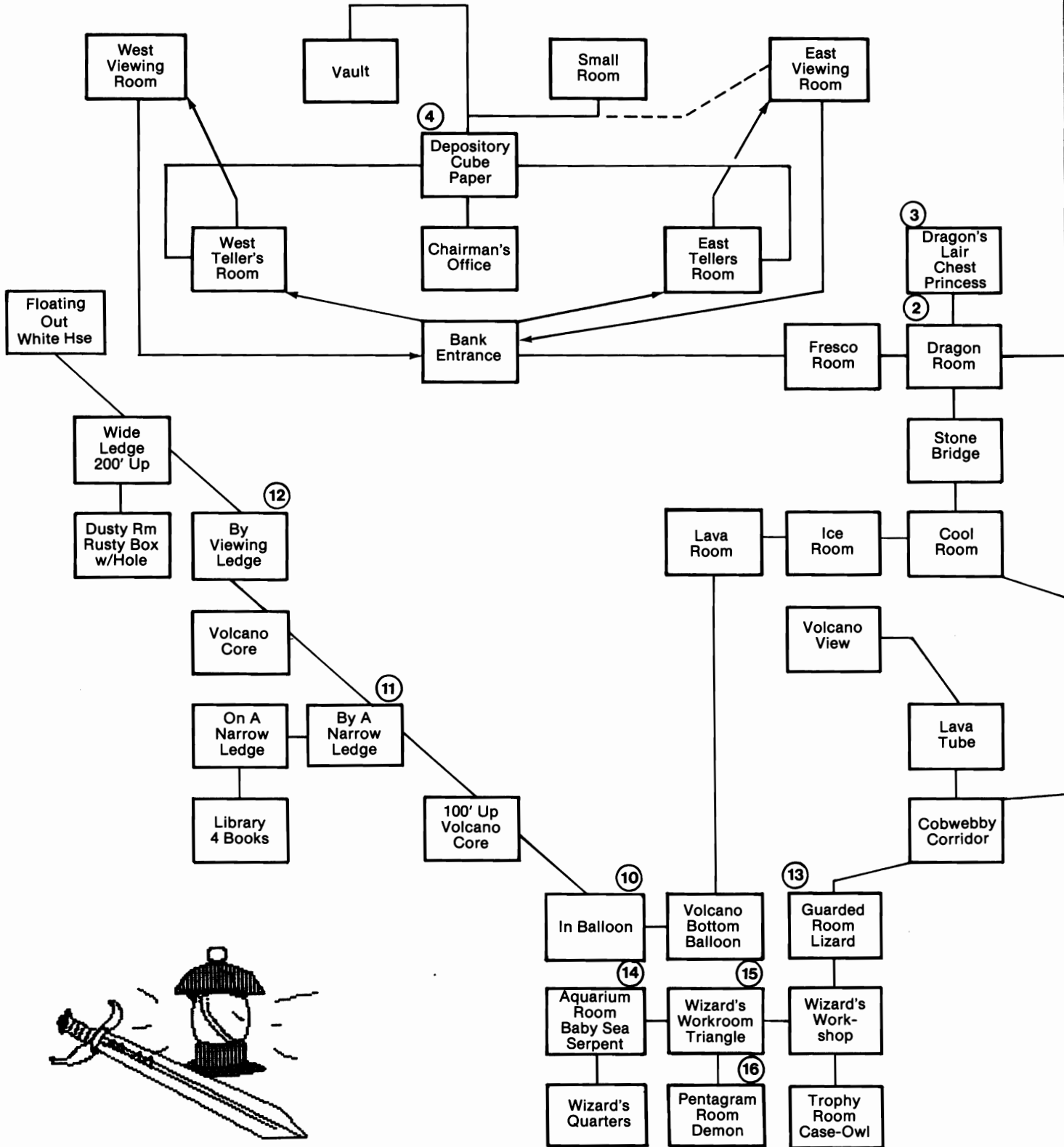

Description:

You start where *Zork I* left off. Another 400 points and ten more treasures will test your imaginative and logical abilities to the limit. You'll encounter a dragon, a unicorn, a princess, a baby sea monster, a huge dog, and a powerful demon. On top of this, the senile master of the domain, the Wizard of Frobozz almost endlessly torments you. You contend with lots of objects, a riddle, and a hot-air balloon from which you may even catch a glimpse of the deserted white house where all this started.

Playability:

Some new material has been integrated into the mainframe version, and it fits like a glove. You face several especially hard nuts to crack, like understanding what's going on in the Oddly Angled Rooms. Things really start picking up once you figure out how to deal with the curious dragon. The ending is quite neat; you may achieve your 400 points—but maybe, just maybe, yet another puzzle lies ahead of you.

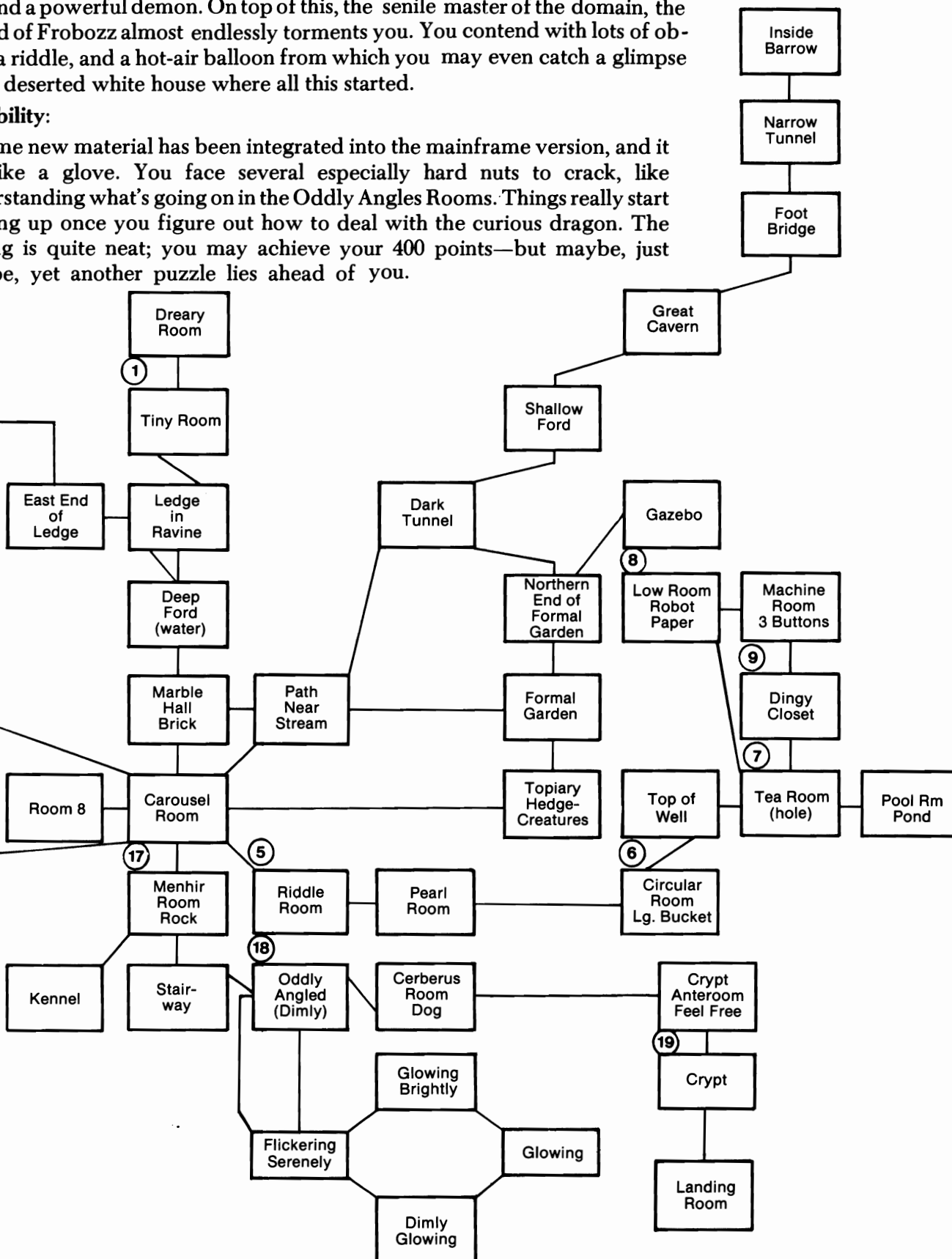

ZORK III

Company: Infocom, Inc.

Suggested Retail: \$39.95

Type: An all-text adventure.

Description:

The best has been saved for last in this book. *Zork III* gets my vote as the best single adventure. You start where *Zork II* left off, armed only with your trusty lantern, having only to round up seven points. You obtain them by accomplishing specific tasks, like mastering the Time Machine from which you may even glimpse the fabled Lord Dimwit Flathead himself. But the seven points are only half of it; the real game still lies ahead of you. Why are you here, and what is the meaning of all that you survey? Have patience, you may find out when all the treasures of Zorkdom, including a controlling interest in Fobozzco International, are at your disposal.

Playability:

If you play this game the same way that you play other adventures, you'll never get anywhere. This time you must consider sensitivity, trust, and human compassion. Yes, educational value occurs here, as well as a lot of interesting puzzles, some of which have alternate solutions. As always, the parser, vocabulary, and save-game capability support the game in beautiful style. The game pays superb attention to detail. Did you know, for example, that the chest is watertight?

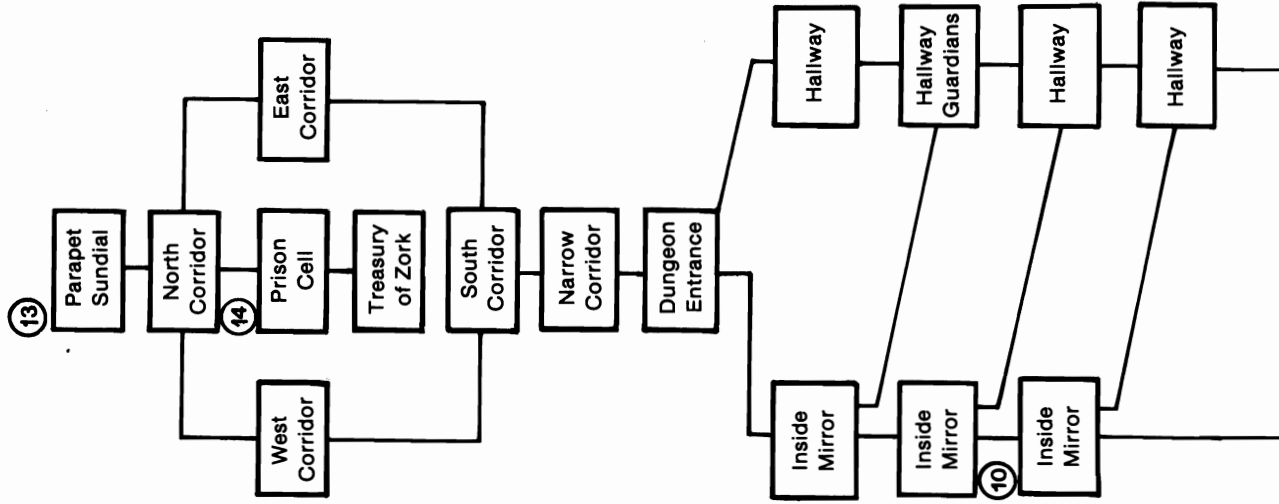

ZORK III

Room In A Puzzle

(Push a sandstone block with a ladder on it back under the starting point to climb out)

M=Marble Block
 S=Sandstone Block
 (Movable)
 2 have ladders
 X=Depression in floor
 with Book in it

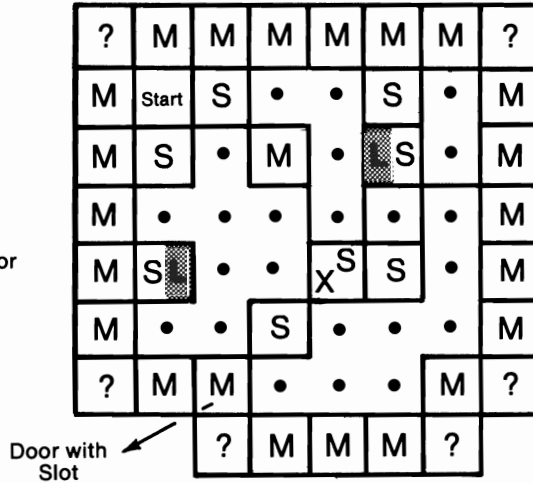

SOLUTIONS

ADVENTURE—THE COLOSSAL CAVE

1. Enter Building. Get Keys and Lamp. The Lamp appears here should you have to be reincarnated.
2. Unlock Gate (With Key). Get Cage.
3. Try the Magic Word, XYZZY. Try it again. Get Rod.
4. Drop Rod. Catch Bird. Get Rod.
5. Wave Rod. Drop Rod. Go Get Diamonds and Gold.
6. Release Bird. Drop Cage. Grab Coins and Silver. Note: Dwarves are lousy shots, but sometimes, unfortunately, they can get lucky. Carry the Axe, as you may encounter up to five of these critters.
7. Try the Magic Word PLUGH also. Drop Silver, Gold Nugget, Diamonds, Jewelry, and Coins. If you haven't already, you will soon encounter a thieving Pirate. Not to worry, he's got to rob you at least once if you're to win all the marbles.
8. Carrying Food, Axe, Bottle of Water, Key (all for later) and Lantern, visit the Software Den (Microsoft Version only). Don't mess with anything—Software types are a weird lot. Get Magic Word LWPI. Works only from here.
9. Water Plant twice. Get Water for the second pass at the Waterfall.
10. Attack Dragon. Yes. Get Rug.
11. Get Oil (in now empty Bottle). Climb the Plant.
12. Oil Door. Open Door. Drop Bottle. While here and while carrying Golden Eggs, enter FEE, FIE, FOE, FOO, one word at a time. Check your inventory. Go back to where you first found the Eggs.
13. Throw Eggs (to Troll). Cross Bridge before the FEE, FIE, whatever.
14. Feed Bear. Unlock Chain (With Key). Get Golden Chain. Drop Key. Get Bear. Don't forget the Rare Spices. At Volcano View, read and remember the words of fire.
15. Release Bear. Don't try crossing the Bridge with him on the Chain.
16. Open Oyster (With Trident). Pearl will roll down into the Cul-De-Sac.
17. Insert Coin to get a replacement battery for your Lamp, if necessary. Coins are a treasure, however, and you won't get them back, so try beating the game with the original batteries only.
18. Never Drop Vase unless you have already dropped the Pillow.
19. Drop everything in order to enter. Get Emerald.
20. Say PLOVER. Get Pyramid. PLOVER, PLUGH and Pi-tooie!
21. You must traverse the maze to get Pirate's Treasure Chest, which doesn't appear until he's robbed you. Return via the Pit and XYZZY. Drop all treasures in the House.
22. Drop Magazine in Witt's End for a point. Get out by entering all different direction *except* North. It may take a while. Slog around in various and distant locations until a Voice announces that the Cave is now closed. At this point you are teleported to the two-room Master's Game.
23. Get Black Rod (with the Rusty Marks, *not* the Star). Drop Rod in the Northeast room. Retreat to the Southwest room. Type Blast. Alternate endings are possible, but will not yield sufficient points to earn you the rank of Adventure Grandmaster.

Treasure List

What	Where
Golden Eggs	Giant Room
Trident	Magnificent Canyon
Pearl	Clam Room
Pirate's Chest	Pirate's Maze
Platinum Pyramid	Dark Room
Emerald	Plover Room
Ming Vase (and Pillow)	Oriental Room
Rare Spices	Chamber of Boulders
Persian Rug	Dragon's Den
Golden Chain	Bear's Chamber
Diamonds	West Side of Fissure
Jewelry	South Side Chamber
Gold Nugget	Gold Room
Silver Bars	North-South Passage
Coins	West Side Chamber

ADVENTURELAND

1. Let sleeping Dragons lie, until much later. (Never go near him with any mud.)
2. In Quicksand take only the Axe. Get Ox. Say Bunyon. Swim South. Go to Paul's Place. En route, get Flint and Steel.
3. Climb Tree. Get Key. Read Web. Chop Tree. May need Mud for Chigger bites. Go Stump. Start dumping treasures. Rub Lamp (Twice only) for two more. With the Rubies directly below, there should now be five. Take Bottle.
4. Unlock Door. Drop Keys. Go Hallway. Light Lamp with Flint and Steel. If Lamp dies, fill with Oily Slime.
5. In Maze, Get Rug and Net. With Rug, get out by Say Away (twice) to transport back to the Meadow.
6. At Lake with filled Bottle and Net, Catch Fish. (Fish die without Bottle.)
7. Get Wine Bladder. Fill Bladder (with Swamp Gas). In Royal Chamber, Drop Bladder. Burn Bladder.
8. Scream (at Bear). Jump Ledge. Get Crown, Mirror and Bricks. Don't throw Axe at Bear or waste Honey on him. Drop Mirror on Rug *only* (get clues).
9. Dam Lava with Bricks. Pour Water. Get Firestone.
10. In Beehive, with Rug, Mud, and empty Bottle, Catch Bees. Take Honey. Drop Mud. Go Meadow. Release Bees. Get Dragon Eggs. (Can make it 50% of the time before Bees die, but using Rug and Say Away is easier.) After dropping all thirteen treasures, say Score. The treasure summary:

Blue Ox	Golden Fish	Golden Net
Jeweled Fruit	Diamond Ring	Bracelet
Rubies	Rug	Magic Mirror
Golden Crown	Royal Honey	Firestone
Dragon Eggs		

ADVENTURE IN TIME

1. Move Picture. Get Robot. Look Robot. Push Stud (will occasionally provide a significant clue). Get Syringe (with Cloth from Lab, or prints are destroyed).
2. Put Syringe (on Microscope Stage). Drop Cloth.
3. Input Nostradamus. Input Hunter.
4. Say Hunter.
- 5a. Insert Brown Card. Insert Blue Card. Pull Lever. Go to Year -5000. Leave Manual here.
- 5b. Insert Green Card. Pull Lever. Go to Year 1001.
- 5c. Insert Yellow Card. Pull Lever. Go to Year -0030.
- 5d. Insert Red Card. Pull Lever. Go to Year 10 Million B.C.
6. Need Translator only. Move Altar. Get Green Card. Collect all objects and head for ship.
7. Need Laser and Flute. Play Flute. Get Snake. Fire Laser (F) to see where you can go. Get Bow and Yellow Card.
8. Need Snake and Bow. After getting Charm, Drop Snake. Get Violin.
9. Rub Notepad (with Pencil). Get Clue.
10. Plant Seeds. Get Plants.
11. Need Robot, Plants, Potion, Bow and Violin. Pour Potion (on Plants). Drop Plants. Climb Dinosaur. Open Compartment. Play Violin. Get Microfilm.
12. Read Microfilm. Input L99AV. Read T1 in Control Room. Input 2396.
13. Get Hammer. Kill Nostradamus. You've saved the world!

THE BLADE OF BLACKPOOLE

1. In Small Room off Tavern, Buy Honey, Rope, and Lamp. Don't buy the Knife or Staff. Buy Ale. Don't drink it. Drop Remaining Gold, nineteen pieces, in front of Tavern.
2. In Quicksand, Swim East then North. Take Potion. Catch Bees (need Honey). On way out, leave Hammer and Rock (never needed).
3. Give Bees to Carnivorous Plant. Won't ever bother you now. On way North, leave Battle Axe (not needed). Drop Honey where Trail Turns North (for later).
4. At Small Pond, Put Potion (on Boat). Take Boat. Go back and Take Shield.
5. Fall in Pit (without a lit Lantern). Throw and Climb Rope to get out. Take Rope again.
6. Light Lamp from Torch. Leave all but Lamp at the Birdsnest. Go back South again. Note that the Lamp will go out if it's ever dropped; it may be tough to get back to the Torch!
7. Take Amulet (where, with unlit Lamp, the Pit was). Give Amulet to Recluse. Take Book. Return to Birdsnest.
8. Carrying Lamp, Boat, Ale, Rope, Book and Shield, Sing. Stand on Pad.
9. At Cliff, Tie Rope. Down. Take Rope. Put Boat in Water. (Don't leave Ropes tied to Cliff tops and go away; they fall down!)
10. Use Rope to Climb Cliff. Take Rope. Take Tuning Fork. Return to Boat. Leave Rope at base of cliff. Paddle North. Note: If you later elect to attack Idol, Rope would be needed, so behave yourself!
11. At the Monster, Pour Ale in Water.
12. At Altar, Say SOLOCIN to Idol. Put Book on Altar. Take Key.
13. At Cave, Hit Boulder with Fork. Drop Fork.
14. With Helmet, Unlock Door (with Key). Drop Key. Take Bow and Scroll out of the Maze. (From Plaque, South, North. Take Scroll. North, East. Take Bow. East, East, East.)
15. At Very Dark Spot in Water, Down (need Helmet, or else).
16. At Lizard, Say MAHDEN. Take Arrow. Shoot Lizard (with Bow and Arrow). Take Sword. Return to Cave. (REGNILO causes all objects to be lost.)
17. At Altar, Put Sword on Altar. Say MYRAGLYM. Get Zapped to the Amulet/Pit location.
18. Head toward Tavern. Take Honey. When warned about hunger, Eat Honey. Should now have 430 points.
19. Enter Tavern with Sword, Moneybelt (nineteen pieces of gold=19 points), for a score of 499. For the last point, try going in with object taken in Step 12.

CASTLE OF DARKNESS

1. Dig North.
2. Kill Orc. Examine North. Get Charm.
3. Look Crack. Get and Read Parchment for clue.
4. Examine East.
5. Examine West.
6. Knock Chest. Get Bar and Ring.
7. Use Bar. Get Key.
8. Kill. Unlock South. Use Key. Don't mess with Troll in Tower.
9. Examine Shoes. Get and Read Coin for clue. So Say It!
10. Whistle. Get Medal. Read Medal for clue.
11. Look Dartboard. Get Arrows (three).
12. Say Vanish. Look Cage. Pull Rope.
13. Examine North. Examine and Go Down also.
14. Examine West. Rub Lamp for clue.
15. Use Umbrella.
16. Get Gloves. Use Umbrella.
17. Shake Gloves. Get Vial. Use Vial.
18. Kill. Examine East.
19. Examine Down.
20. Examine North.
21. Enter Maze. From first room in the maze, go N.S.E.D. Get String. Make Bow (need Pole). Return by West, Down, North.
22. Use Bow (three times). Don't Carry Ring.
23. Use Material. Open North.
24. Say Grimmacht. Use Medal to open door. Open Envelope. Get Pill.
25. Eat Pill. Kill. Get Princess. Break Ball. You should earn 200 out of 200 points if you picked up the treasures along the way.

CHAMBERS OF XENOBIA

1. Examine Formation. Get Key.
2. Open Door (with Key). Get Vial.
3. Throw Vial. Get Platinum.
4. Examine Clock. Set Clock. 12. Get Huge Emerald.
5. Say Cowabunga.
6. Drink Potion. Open Gate.
7. Examine (Dead) Ogre. Get Rubies.

Treasure Values

Onyx Statue	10
Brass Carving	10
Gold Doubloons	15
Gold Bar	15
Sapphire	15
Gold Necklace	15
Bunch of Emeralds	15
Platinum Ring	15
Diamond	15
Rubies	15
Huge Emerald	20
Platinum	30
Total	190

THE COUNT

1. Day 1. En route to Dungeon, enter and raise the Dumb waiter. Go Room and Get Matches and Garlic. In Dungeon, Tie Sheet. To Ring. Climb Sheet. Light Match. Get Torch. Climb and Untie Sheet. After hearing bell ring, go Outside of Castle and get Clip on the Note. Drop the note. (In this game, specific tasks must be done in each of three days and two nights.)
2. Day 1. Pick Lock in Workroom. Get Vial. Drop Wooden Stake. Lock Closet. Leave Clip outside. Take Mallet along. (Items left locked in Closet won't be stolen.)
3. Night 1. Eat Pill. Go Oven. Get File. (There are sixty-five moves/day, thirty-eight moves/pill; the Bell rings twenty-five moves before sundown.)
4. Day 2. With File, Mallet and Sheet, Tie Sheet to Bed. Open Window. Throw Sheet out Window. (Don't climb on the Sheet with a lit Torch!) Move and drop Portrait. Leave Mallet and File in Crypt.
5. Day 2. Await Package delivery Outside Castle. Take one cigarette. Lock up balance in the Closet.
6. Night 2. Eat Pill. Go back to Crypt. May have to negotiate the climb in the dark. Climb Sheet. Go Box. Go Window. Light Torch. Smoke Cigarette. Open and Go Coffin. File Locking Bolt with File.
7. Day 3. In Crypt, with Stake and Cigarettes. Drive Stake.

THE COVETED MIRROR

1. Move Bed.
2. Get a piece of the mirror.
3. Open Cupboard. Take Vase. West to return to Magician's Room. Should you lose everything to Voar, this is where it will all be found.
4. Wait. Give Necklace to Boris. The vertical bar next to the hour glass represents the time you've got until you get yanked back. The Necklace, Broom, Ax and Cookie each will allow some extra time. The Telescope, Picture and Jug will allow even more.
5. Open Window. East.
6. The Ax will buy a little time from Boris.
7. Take Ball. Mermaid. Take Ball.
8. Take Telescope. Orion. Scorpio. Gemini. Take Telescope. Its only use is to buy time, but you can see some nice things through it.
9. Drop Ball. Get Clue about the Vase.
10. Use Lockpick. Open Stocks. Go South or West and Joust. Later in the game you'll need to have done this.
11. Move Barrel. Go Barrel. East to Cell, or West to Magician's Room. Buy some time from Boris. Move Bed, West, Go Barrel to get back to Town.
12. Take Candlestick (need to have Thief with you). No, you can't read the Abbot's book—yet.
13. Give Candlestick. Get Bellows and Candle. Next time in Magician's Room, Light Candle, Open Cupboard, East. Take Ring and read the clue.
14. Give Bellows. Get Shovel.
15. Use Shovel. Get Bones.
16. Take Picture. Bear. Take Picture. Its only use is for ol' Boris, but it's relatively potent. Take Grain from next door.
17. Move Glasses. Get Color Spell. Take the Ladder on the way out. The Bird and Nest are window dressing. Go North and do the Fishing bit, as it is needed for you to read the Abbot's book.
18. Give Grain. Open Door. North. Open Door. Get Rope.
19. Get Shadow (need Vase).
20. Drop Ladder. Up.
21. Drop Rope. Up. Give Bones. Give Vase. Get Invisibility Spell. Watch the time remaining in your hour glass.
22. After catching fourteen fish, read the Abbot's Book. When you next visit the Chapel, you'll get another piece of the mirror.
23. Use Invisibility. Clean out the Castle (i.e., Fish, Moose, and Broom).
24. Wait. Talk to the Jester (must be visible). Give Horseshoe. The next time back in the Cell, you'll get another piece of the mirror.
25. Use Lockpick. Open Door. North. Use Color Spell. Get another piece of the Mirror.
26. Give Fish. Get Coat.

27. Give Moose. Get Cookie. Another time buyer.
28. After you have all four pieces, you may enter the Tavern without losing any of your inventory. Jon's there, so Talk. Flip the disk and learn sign language.
29. If you know sign language, Talk. If Old Man isn't there, Wait. The way to the North is now open.
30. Drop everything except the Coat. North.
31. Wait until the correctly shaped mirror piece comes along. It's the one that looks like a simplistic paper boat. Take it and watch the finale.

CRANSTON MANOR

1. With Lantern and Crowbar from Town, Pry Gate (on West side of the Manor).
2. With Cheese (from Kitchen) and Cage (from Atrium), Drop Cheese. Catch Mouse. Get Cheese. You can now deal with the Suit of Armor, on a room-by-room basis, by Drop Mouse.
3. Hit the Kitchen. When you were here the first time, the text said there is a Pot on the Stove. Subsequently, the word Pot isn't repeated, but its a key item.
4. Use Coin. Get ID Card. Move away from the Toy Soldier as you can't handle him, yet.
5. Get Water (with Pot).
6. Use Card.
7. Throw Water. Disabling Computer permanently deals with both the Toy Soldier and the Suit of Armor. Balance of game is largely a matter of collecting the sixteen treasures and dropping them at the Front Gate. (Don't forget the Sphere.)
8. East. (Debris moves out of your way.) Get Jade Buddha.
9. Lantern Off. East. Lantern On. East. Get Nugget.
10. Drop Nugget. Lift Up. (Goes to second floor.) Get Water at Pool again and clear out the other Basement treasures (Gold Eggs, Gold Bars and Sapphire).
11. Prime Pump (need Water). Push Button. Get Bottle (of Diamonds).
12. Open Drawer. Get Key.
13. EMASES. Get Gold Spyglass.
14. Unlock Door. Use Key. Climb Rope. Swing Rope. Get Bills.
15. Play Organ. North.
16. Pull Torch. Get Nugget.
17. Open Dresser. Get Necklace. Jump (off Balcony). Down.
18. With Screwdriver (from Shed) and Liferaft, Inflate Raft. North. Use Screwdriver. Get Emeralds. Drop treasures at Front Gate and be declared a Level 3 Adventurer.

Object List

- | | |
|-----------------------------|--------------------------------|
| 1. Crowbar (Town) | 7. Pot (Kitchen) |
| 2. Lantern (Town) | 8. Cage (Atrium) |
| 3. Key (Smoking Room) | 9. Cheese (Kitchen) |
| 4. Gold Coin (Garage Attic) | 10. Mouse (Mouse Room) |
| 5. Dagger (Secret Room) | 11. Subway ID Card (Subway) |
| 6. Screwdriver (Shed) | 12. Inflatable Boat (Playroom) |

Treasure List

1. Jewelry (Gazebo)
2. Candlestick (Dining Room)
3. Crystal Triangle (Secret Room)
4. Teapot (Sitting Room)
5. Sapphire Pendant (Intersection)
6. Pearl Ring (Master Bedroom)
7. Necklace (Bridal Suite)
8. \$50 Bills (Above Closet)
9. Emeralds (Piranha Pool)
10. Gold Bars (Sloping Corridor)
11. Platinum Sphere (Computer Room)
12. Gold Spyglass (Lookout)
13. Golden Eggs (Large Chamber)
14. Gold Nugget (Lift Chamber)
15. Jade Buddha (Basement)
16. Bottle of Diamonds (Cistern)

CREATURE VENTURE

1. Climb Tree. Get Key—see a Knife.
2. Say Sesame (check the Mailbox). Get Batteries. Go Door. Get Knife.
3. Go Crack.
4. Unlock, Open and Go Door (need Key).
5. Look Table. Get Glasses. Look Picture to see where to dig.
6. Look Stairs. Get Flashlight.
7. Say Beelzebub to open door to Maze. From the Library, go N.W.N.E.N. Kill Bazoo (need Knife). Get Shovel. Return to Library by S.W.S.E.S.
8. Drop Shovel. Elf will throw it out. Go Crack. North. Say Boo. Get Magic Lamp. Drop Shovel. Go Crack.
9. Go Mirror (need Flashlight and Batteries).
10. Look Pillars. Get clue. (Indian Partner.)
11. Rub Lamp. Get Wand.
12. Say Tonto. Get Bottle of Water.
13. Water Tree. Climb Tree.
14. Rub Lamp. Clobber Kybor. Punch Boogieman. Get Cage.
15. Get Fireflies (need Bottle). Wave Wand. Fireflies permit Flashlight to be dropped; besides it's almost burned out.
16. Drop Wand. Get Bat (need Cage). Don't get Bat before the Fireflies as Bat will eat them.
17. Rub Stump. Drop Flashlight if you haven't already done so.
18. Release Bat to clobber Snake.
19. Drop Lamp (Lucifer goes blooey). Get most of the treasure. Move on to the Master's Game. Check your inventory; this is a completely different game and is a good exercise in move planning and inventory management.
20. Say Shazam.
21. Cut Tree. Get Rubber.
22. Get Pick. Drop Gum. Get Cake on way back.
23. Drop Knife. Go back and Get Ring. Forget the Cup.
24. Eat Cake.
25. Dig. Drop Pick. Go North and Get Rug and Pencil. To save moves, Fly (need Rug). Fly again.
26. Rub Box. Kiss Snakes.
27. Draw (need Pencil). Drop Pencil. Get Key. Fly.
28. Rub Ring.
29. Unlock Door (with Key).
30. Tickle Squid. Get rest of Treasure and zap back to the starting point.

CRIME STOPPER

1. 2nd Ave. & 90th St.: Open Drawer and load up. Answer Telephone and Read Telegram. Turn on TV. Change Channel. Go up on Roof for the Hanky, but don't expect it to be of any use.
2. 2nd Ave. & 90th St.: In Secretary's Office, Move Picture. Get combination L36-R26-L26.
3. 2nd Ave. & 90th St.: Buy a Newspaper for more information. Be ready with the ESCAPE key to stop scrolling.
4. 2nd Ave. & 50th St.: At the Sizemore Building, Tell Guard, Al Clubs.
5. 2nd Ave. & 50th St.: The Subway Platform is a good storage location. For now, Take Money, Bank Card, Cigarette, and Lighter.
6. 6th Ave. & 8th St.: A convenient place to get enough money for carfare and bribes. Insert card. 10-28-81. Cannot carry more than \$99. Don't forget Bankcard.
7. 2nd Ave. & 8th St.: Room 209 is at end of hall. Wait for telephone call. Read Receipt.
8. 10th Ave. & 21st St.: Bribe the man in Skid Row doorway (three times at \$5 per).
9. West & 8th St.: In Warehouse, Look until you get clubbed. Waking up in Freezer, Stand on Desk. Light Lighter. Light Cigarette. Get Stub. No hurry—twenty moves available before freezing. Drop Cigarette and Lighter.
10. 6th Ave. & 90th St.: In Theatre, get Invitation by the drugged Beau. The hypo is useless.
11. 10th Ave. & 90th St.: In Apartment, Turn Dial (Left or Right). Be ready with the Space bar. Don't ask why, as it has no known bearing on the game. Stop just before each number (L36-R26-L26) and creep up on it.
12. 2nd Ave. & 90th St.: On Station Platform, a man should approach with a message.
13. 6th Ave. & 50th St.: Phone will ring, so answer it. This is a good place to check your money, although you don't need too much more.
14. 2nd Ave. & 135th St.: Find Dead Man. This is Bug City—don't go here before getting the phone call, because then you can't leave the room. Probably a key on the body—but I couldn't get it! The Blowgun and Dart are of no use.
15. 6th Ave. & 21st St.: The locked locker is presumably what the missing key is for. The code indicates that there are Barbells in a Dufflebag inside.
16. 2nd Ave. & 50th St.: Pick up suitcase of money at 6 PM. May have to Wait/Look to get time to move on.
17. West & 21st St.: Deliver ransom by dropping Suitcase at lockers at 9 PM, not before.
18. West & 21st St.: Wait and watch for Crowded Corridor. If no one comes by 10 PM (the courier is Livwell), he won't come due to a bug in the program. (On six near-identically played games, he appeared only twice. Perhaps a flag wasn't set by doing something which seemed to have no bearing on the game, like not getting the Hanky or going to the "wrong" bank.)
19. 2nd Ave. & 50th St.: Follow Man to Sizemore Building. Enter elevator with him. Shoot Man as soon as he recognizes you—don't try the command Shoot Livwell.
20. 2nd Ave. & 50th St.: On roof, Shoot Man (not Shoot J.J.). When Cartier breaks away, Pull Lever.

CRYPT OF MEDEA

1. Take Candle. Pull Tombstone. Look Crypt. Get Matches. Light Candle. Move Case. Down.
2. Burn Hand With Candle. Take Shovel.
3. Dig. Pull Knob.
4. Look Head. Take Card. Search Corpse. Get Vial. Push Orange.
5. Uncork Vial. Throw Vial at Web. Get Tape.
6. Play Tape (need Tape and Cassette Player). Put Card in Slit. Take Diamond.
7. Cut Case With Diamond. Get Mask. Get Glass.
8. Cut Rope With Glass. Get Rope. Leave the Buttons alone.
9. Drop Candle before entering. Wear Mask. Push Violet. East. Get Rod.
10. Push Yellow. Push Orange. West. Push Blue. East.
11. Having Rod will protect you on entering here.
12. Throw Rope. Carrying only the Candle and Glass, Swing.
13. Throw Glass at Mutant. Get the Magnet to the North.
14. Use Magnet. Get Key.
15. Unlock Door (need Key).
16. Get Gloves. Go back across Chasm.
17. Wear Gloves. Get Dog. Go back across Chasm.
18. Throw Dog at Scum. Look Moss. Turn Valve (empties Vat).
19. Look Vat. Down. Get Hypodermic. Go back across the Chasm again.
20. Inject Jelly with Hypodermic. Pull Trapdoor. Carry the Shovel, Gloves, Knife, Flask and Candle. Save game—you can't return once you've gone down.
21. Dig. Don't forget the Torch. Light Torch.
22. Pull Switch. Wait until you hear a Thud to the West. Go West to Get Timbers and Fuse.
23. Slice Lard. Get Slice. Put Slice in Flask. Light Burner. Melt Slice With Burner. Oil Dial. Drop Burner and Flask.
24. Should the door to the East close, Wear Gloves. Push Button.
25. Build Bridge (need Timbers from the Cavernous Room).
26. Wear Plugs (need Earplugs from the Dead End). Get Barrel. Make Bomb. Don't read the inscription.
27. Holding Bomb, Light Fuse. Drop Bomb. South. (You literally have only a few seconds to type these commands, so be accurate and fast.)
28. Use Axe.

CRYSTAL CAVERNS

1. Key to Gate is in Eastern Tangle of Bushes. It will be used again. Get Oil and Pliers. Knock on Door.
2. Move Statue. Get Stool.
3. With Oil from Tool Shed, Oil Hinges. Drop Oil. Open Trapdoor. Drop Diamond Bracelet in Cupola. Get Lamp.
4. Stand on Stool in Parlor. Move Picture. Get Off Stool. Drop Stool. Keep Lamp on only long enough to get Candelabra. Drop it in Hallway for now. Get Burger.
5. With Shovel, Lamp, Key, Burger, Pliers, Hard Disk, and Parachute. Dig Stump in Second Clearing. Down. Light Lamp. (Note: The Junction is a neat place to temporarily dump objects and treasures.)
6. Jump Down off South Wall of Fissure with Parachute. Get Bottle and Read Message. Drop Parachute at Many Passages. Go Down for Painting.
7. Turn Dial in Furnace with Pliers. Get Sapphire. Get Goblet. *Don't* do Step 8 first or Goblet breaks and becomes worthless.
8. With Pickaxe from Quarry, Pick Boulder.
9. Dig Sand (with Shovel). Get Computer Magazine.
10. Dig Pit (with Shovel). Get Ivory Tusk. Drop Shovel. Don't try to parachute from Ridge of Wide Fissure location.
11. Haul the Crowbar from NE Corner back to Quarry. With it, Move Boulder. Get Pearl Necklace. Keep Crowbar.
12. Carrying Disk, Key and Burger, Feed Flytrap (Burger). Get Stamp. Check out Generator Room, but don't take in the Hard Disk. Compass is telling you about strong magnetic fields.
13. At End of Passage, Unlock Door with Key. Drop Key. Should have Lamp, Computer Magazine, and Hard Disk.
14. At Disk Drive, Push Red Button. Push Blue Button. Put Disk in Drive. Push Blue Button.
15. At Computer Panel, Push Load Button. Per Magazine, \$\$A\$SUP2. ISS. DPD. Get Printout at Dusty Printer.
16. Haul Lamp, Crowbar, Pick and any four treasures to Cupola. Leave rest at Junction. Turn off Lamp at Bottom of Hole.
17. In Study, Break Globe (with Pickaxe). Drop Pickaxe. Turn Globe. Get Ruby. Should now have seven treasures stashed away.
18. In Tool Shed, Pry Floorboard (with Crowbar). Drop Crowbar. Leave Board.
19. Enter sixteen room maze. Use printout as map. SE.NE.NW.SE. Get Violin. Leave by North, East, South. Alternative: There is a Power Pack for Lamp recharging, needed if you klutz around underground too long. From Violin, go N.NE.SE.E.SE. Get Pack. Leave from there by NW.S.E.S.
20. Flick Switch to Open Panel. Can't be opened from other side. Going with the Platinum Record, Rug and Jade Ring, and on to the Junction, haul five more treasures topside. Make one more trip to the Junction for the last four treasures. Last treasure in yields a 45 point bonus for a total of 500 points for the new Apple Caverns Estate Landlord.

Treasure Summary

- | | | | |
|---------------|--------------|---------------|----------------|
| 1. Bracelet | 5. Record | 9. Goblet | 13. Painting |
| 2. Candelabra | 6. Bear Rug | 10. Stamp | 14. Necklace |
| 3. Ruby | 7. Jade Ring | 11. Wine | 16. Ivory Tusk |
| 4. Violin | 8. Sapphire | 12. Doubloons | 16. Toothpicks |

Object Summary

- | | |
|-------------------|--------------------------------|
| Oil Can | Rusty Hinges |
| 1. Wooden Stool | Use in Parlor |
| 2. Key | a) Front Door |
| | b) Computer Room |
| 3. Pliers | Use in Furnace Room |
| 4. Shovel | a) Second Clearing |
| | b) White Sand |
| | c) Small Pit |
| 5. Burger | Venus Flytrap |
| 6. Pickaxe | a) Small N.S. Passage |
| | b) Use in Study |
| 7. Parachute | S. Wall of Fissure <i>only</i> |
| 8. Hard Disk | Disk Drive |
| 9. Crowbar | a) Quarry |
| | b) Tool Shed |
| 10. Piece of Wood | No Use |

CURSE OF CROWLEY MANOR

1. Climb in. Say Crowley. Look Driver. Get Vial. Look (three times). Get out.
2. In Dining Room, Drop Growth (from looking at Kitchen floor). Look Plate. Shoot when it starts to grow. Open Cabinet. Get Axe and Letter Opener.
3. In Music Room, Turn Crank. Get Key. Will unlock Cabinet in Hallway.
4. In Parlor, Unscrew Cabinet (with Letter Opener). Get Crucifix. Read and remember the combination 5271. Drop Letter Opener.
5. In Study, Open Desk. Get Crystal Ball. Read Book, twice.
6. In Storage Room, Chop Hole in Wall. Climb in Hole. Carry along the Revolver, Statue, Crystal Ball, Crucifix, Vial, and Axe.
7. In Dingy Room, it's hopeless unless you have the Crucifix, Vial, and White Elephant from the South End of the Hallway. With them, no evident problem. Dial 5271. Open Door. To get back through, if necessary, Open Vial.
8. In Stark Room, Say Gafala. Climb in Wall. Talk to him in Crystal Room. A good Save Game location.
9. In Low Ceiling Crypt, don't Look around. There is a Silver Club, but the Demon will usually teleport you and leave immediately.
10. Play Mozart. Climb Stairs.
11. Look Up. Climb Rope.
12. In Great Silver Room, Put Crystal Ball in Depression. Look at it. Get Sword.
13. Wide Dark Smelly Pit is no problem if you have the Sword. Good place for a Save Game.
14. After Rat bites off part of your arm, Fire Revolver.
15. Objects required in the Smelly Pit are the Vial, Crucifix, and Axe (to Chop Beams).
16. Clean Sword in the Green Fountain.
17. Beyond the Gigantic (Dark) Cavern, just keep Looking at the Demon until he offers for you to join him. Takes about seven Looks. You then have one chance to Kill Demon.

CYBORG

1. Get Microlaser. Wear Laser. Shoot Snake. Energy=35.
2. Going down from Rising North-South Path, Get Sneakers and Matches. Backtrack for Power Pack, Step Ladder (Light Match).
3. Get Cube. Cut Cube. Open Cube. Get ID. Insert ID.
4. Insert Card, Get Apple. Eat Apple. Get ID. Wear ID.
5. Cut String. Get String. Lace Sneakers. Wear Sneakers. Get Power Unit and Shoulder Harness. Wear Harness.
6. Climb Tree (wearing Laced Sneakers). Get Fruit. Feed Lizard. Fruit. Ask Lizard (Ask 1, Ask 2, etc).
7. Must be wearing Sneakers to enter Gym. Open Hatch. East. Light Match. Get Droid. Get and Wear IR Lenses.
8. Break Trapdoor. Pet Togram. Ask Togram (Ask 1, Ask 2, etc).
9. Press Plate (must be wearing ID). Drop Ladder, Fiche and Cube off temporarily at Resting Spot, 50 Meters down. Go down to Bottom of Shaft.
10. Shoot Robot (with Microlaser). Energy=45. Break Chest (of Robot). Open Casing. Get Power Cell. Wear Cell. Get Tools.
11. Untie String. Give String (to Iguana). Drop Sneakers. Get Manual. Return via Dormitory, Get Bread. Unlock Locker. Get Solder. Get and Wear Power Battery.
12. Get and Eat Juicy Peach. Get Bundle of Wire. Break Grill. Shoot Smada (with Microlaser). Energy=45. Get Beaker. Fill Beaker (with Liquid Oxygen).
13. Unlock Latch (need Tools). Enter Cylinder. Close Panel. Pull Lever. Feel Better?
14. Haul load of stuff, including Ladder, Fiche, and Cube to North-South Corridor. Drop Ladder.
15. Insert ID. Insert Fiche. On Reader. Get and Wear ID again. Leave Fiche.
16. Drop Cube. Take Crystal. Leave Crystal by Ladder for now, or go Up and Drop it on Bridge.
17. Remove Droid. Drop Droid. Get Pressure Suit. To wear Suit, remove all objects (can still wear lenses). Drop all items.
18. Save Game. Push Button (wearing Pressure Suit). West. Best bet is to go by horizontal and vertical coordinates shown at bottom of screen. Air lock coordinates are 22 and 13. Hole coordinates are 7 and 25. Move back, down to 13, left to 25, and forward. Reverse process to get back. Time and air go quickly, however.
19. Insert ID to open Cargo Hold.
20. Empty Beaker. Light Match. Drop Match. Ask Reptile. (Ask 1, Ask 2, etc). Give Bread. Get CPU. Nothing else in Maze.
21. Drop CPU, Solder, Wire, and Crystal. Carry Tools and Manual. Repair Dial. Turn Dial.
22. Throw Switch. Receive the Entire Human Race's Thanks.

Object List

Object	Usage
Microlaser	Wear and Shoot Snake, Robot, Smada
Matches	Dark Places and Explode Oxygen
Black Cube	Holds ID and for Scale
Ultrafiche	Used in Reader
Power Unit	Worn
Shoulder Harness	Carry Mini-Droid
Mini-Droid	Gets Pressure Suit
Stepladder	Access to Bridge
Beaker	Carry Liquid Oxygen
Liquid Oxygen	Clear Rubble in Hold
ID Card	Insert or Hold—many places
Apple	Eat
String (Pieces)	Lace Sneakers and for Iguana
Sneakers	Climb Tree and Gym
Strange Fruit	Feed to Forest Lizard
IR Lenses	Wear
Juicy Peach	Eat
Stale Bread	Feed to Lizard in Ship
Power Pack	Worn
Permanent Power Cell	Wear Cell
Sleeper's Manual	Hold to Repair Dial
Set of Tools	Hold to Repair Dial
Bunch of Solder	Drop to Repair Dial
Loop of Wire	Drop to Repair Dial
Power Crystal	Drop to Repair Dial
CPU	Drop to Repair Dial
Pressure Suit	Repair Leak in Ship

DARK CRYSTAL

1. Visit the dying Ursu for information. (Ask Ursu.)
2. Get Shale.
3. Dig. Get Flute.
4. Look Stream. Get Pebbles. Ask Brook. This action reveals a previously hidden path to the East. Brook is giving you directions.
5. Get Slingshot. If Bat appears, Sling Pebble. At Bat. If Garshim appear, just move away.
6. Cut Pad (with Shale).
7. Sit Rock. Later, with Kira, don't go with Chamberlain if found here, at least not without a recent saved game.
8. Float Pad.
9. When trapped in the Vines and Aughra appears, Say Moon, the answer to Ursu's riddle.
10. Say Shard. Play Flute. Get Blue. Go Window (when Garshim invade).
11. Help. Meet Kira.
12. Turn Shell. Get Pouch (Smoke Seeds—not too helpful). Enter Shell.
13. Scrape Moss.
14. With Kira, Ride Landstrider.
15. Enter Castle from any direction. Jump.
16. Grab Kira.
17. At Stone Faced door, with triangle inscribed within a circle, Look Face. Send Fizzgig. Through Bars. Get Key. Unlock Bars. Open Bars. Enter Door.
18. Not to worry, Kira is supposed to get kidnapped here!
19. Don't dally about. Run. Go Hole. Untie Aughra.
20. On hearing footsteps, South, West. (Skeksis go to lunch.)
21. Go Curtain. Listen. Hidden Door will now appear in the Attic.
22. With Scepter from Throne Room, Use Hook. Go Panel.
23. Jump.
24. No. Restore Crystal.
25. Kiss Kira. Live happily ever after.

DEADLINE

1. Read Calendar (July 7). Turn Calendar (July 8). Rub Pencil on Notepad. At about 9:00, the phone will ring. Pick up Phone.
2. Get Loblo Bottle. Read Loblo Label.
3. Around 9:15, an envelope will be delivered to the Foyer. Open Envelope and Read the Letter. Interesting possibilities, but you'll never get a conviction!
4. Around 11:25, the Herald (newspaper) will arrive. Read Paper. Read Second Section.
5. Around 12:00, attend reading of the Will. Show George the Calendar. Follow George (who is upset and goes to his room), and go out on the Library Balcony. Look into Library. Save Game when George appears. When George disappears, enter Library and Examine Bookshelf. Push Button after three Waits (give him time to open the safe). Alternate solutions evolve by waiting for longer or shorter periods. Try them all. Get Stack of Papers. Have fun with the new Will.
6. After around 11:20, find McNabb, who will be mumbling to himself. Ask McNabb about the Roses. Ask McNabb to Show Me the Holes. Follow McNabb. Dig in the Soil. Search the Dirt. Analyze Porcelain for Loblo. Get Lab Report (later).
7. Ask Dunbar about Loblo Bottle. Show her the Lab Report. Accuse Dunbar. (She should be very uptight now, and if Baxter is present, should glance nervously at the two of you.) Move away and wait for her to pass by you. Follow Dunbar (out the Front Door), where she will fish for a cigarette. Get (dropped) Ticket Stub. Ask Dunbar about the Ticket Stub.
8. Wait and Follow until Dunbar and Baxter are together. Show Baxter the Newspaper and the Second Section. Ask Baxter about Ticket Stub. Show him the Lab Report. Show him the Stack of Papers. Save Game. Arrest them individually, then Arrest Baxter *and* Dunbar. Try hiding behind shed; if they aren't already there, they'll come.
9. As an alternate, don't arrest either. Wait in Foyer for Dunbar to go by, heading for her room. Wait upstairs for pistol shot. With everyone assembled in Dunbar's room, Ask Baxter for Pen. Arrest Baxter. As a second alternate, wait for Dunbar in her room, talk a while, and then leave. By the way, did you ever read the end of the book in the Living Room?

DEATH IN THE CARIBBEAN

1. Get Rope. The Seat will only occupy valuable space in your four object carrying capacity.
2. Move Rock. Get Rock (need Wagon). Look Box and Get Key.
3. Cover Hole. Rock. Much as you may like to get the red lining to wave at the Bull, you won't. Go North and get the magical Ring.
4. Tie Rope. Tree. Tie Rope. Wagon. Drop Wagon. Climb Down Rope. You can't get the Wagon back up the Cliff via the Rope, but you can, if you must, get it back up by rubbing your Ring.
5. Look Sign. Get Corkscrew. Go Get the Bottle. No, the River cannot be crossed here. By now you no doubt have random objects taken by the Elf, which can be dug up in the Cemetary. His actions are cut off by carrying the Amulet, but it's a good idea to save games fairly often, both for this reason and because some puzzles give you only one command before you're killed.
6. Using the proper letter substitutions, the message translates to "PYRAMID MARKER GUARDS BURIED CHEST. EXCAVATE WITH GREAT CARE."
7. A neat puzzle with neither a known nor needed solution as far as the overall game is concerned. You can try Kill Bull, and may Aim Gun at him or Cut Horn (with Sword), but just try to get by him.
8. Cross River (need Wagon). Wagon(need Shovel). Shovel. You can't save the Wagon, but once you've seen the Alligator, that word is recognized as a location by the Genie of the Ring, together with the previously seen and known locations such as Monument, Cliff (top), and Church.
9. Open Bottle (need Corkscrew). Empty Bottle (poison, anyway). Cork Bottle, which is now full of Fog.
10. The Inverted Pyramid and Parrot make up another red-herring puzzle.
11. Bring the Lantern here to light it. Leave Matches. There is no way to stop the Storm, and, hence, no way to enter the cave from this side.
12. Might as well Eat the Cookies and Drink the Milk—they have no other requirement in the game.
13. To get the Hat, Rub Ring. Cliff. Untie Rope. Get Rope. When you can again Rub Ring, go back to the Alligator and go into the Quicksand. Get Hat. Wear Hat. Throw Rope. You will lose the Rope and any objects you are carrying, but not those being worn.
14. Read the Music. Note that it's written in the key of G (OK, OK, so it looks like a C, but you want to solve this thing, don't you?)
15. Look but don't mess with the Bell Rope. It's another would be puzzle that's a red herring. Open Trapdoor. Go Down. Carry the Key, Fog-filled Bottle, Corkscrew and Lantern. Wear the Ring, Amulet and Hat. Get the Sword and Drop Key for it.
16. Open Fog-filled Bottle (need Corkscrew).
17. Cut Fog (need Sword).
18. Dig (after going back for Shovel). Are you ready for this? The Key is G!

DEMONS FORGE

1. Get Costume. Look Costume. Get Vial.
2. In Sleeping Quarters, Open, Look, and Move Chest. ("Box" won't work.) Get Pillow, Blanket, and Bag.
3. In Old Armory, Follow Man. In his room, Give Ration. Get Rod. (He only appears on the first visit to the Armory.)
4. At Birdshhead, Insert Rod. Get Red. Rod disappears.
5. At Brazier, Burn Bag. Joe, the Elemental, will accompany you.
6. At Two Doors, Open Doors (need Elemental). Attack Assassin. Drink Vial. Attack Assassin. Search Assassin. Get Chimes.
7. At Well, Fill Vial (with Water). Jump. Need Elemental, who then disappears. Ring Chimes.
8. Do precisely what the first Sign says. Go Left, then Go Right for five moves.
9. In Magician's Room, Give Water—Rabbit. (Not To Rabbit, and don't Pour Water.) Get Wand. Leave Hat, Vial, Chimes.
10. At Rubber Door, Use Wand. Smother Fire (with Blanket). Get Axe. Wand may be dropped. (The Sword, Anvil and Waterfall have no bearing on the game.)
11. At Mirror Maze, Break Mirror (with Axe). Drop the Axe.
12. In Garden, Dig Garden. Get Carrot.
13. In Sleeping Quarters, Climb Rungs. Get Boots and Pendant. Don't Wear Boots as they are a one-shot item. (Rungs are hard to see on the first issue of the game, but have improved in second version, which has improved graphics.)
- 14a. Get First (Glowing Stave). Wear Boots. Dig Ceiling (with Shovel). Get Mound (of Dirt). Go to Ore Hopper. Fill Hopper (with Dirt).
- 14b. Get Second (Glowing Stave). Go to Torch on Wall. Burn Second (Stave).
- 14c. Get Third (Glowing Stave). Go to the Glass Room. Get Bottle. Fill Bottle with Air. Go to Old Well. Drop Third (Stave). Read Bottom.
- 14d. Get Fourth (Glowing Stave). Drop Fourth (Stave).
15. At Dropoff, Drop Pillow. North.
16. At Long Bridge, Drop everything before crossing. Get three Spheres.
17. Juggle Spheres. East (Crossing Bridge again). Pick up just the Carrot.
18. At Altar, Move Altar.
19. At Antechamber, Close Door. Get Key.
20. At Ledge, Eat Carrot to read the sign.
21. At River, Throw Key. Swim River.
22. At Locked Room, unlock door with Key.
23. At Arankull, Throw Silver, Gold, and Platinum Spheres in that order. You are now set free.

DOOM VALLEY

1. Get Cashbox. Open Cashbox (with Key from Ski lift).
2. Rent Equipment.
3. Pull Cord. Jump (with Parachute from Wrecked Plane).
4. Build Bridge (with Skis).
5. You can Attack Knight, but it's not necessary. Go Get Pick, but don't Open Bookcase.
6. Don't go by the Book, Push Lever (disables Lasers on the Stairs). Pull Lever and you meet your doom.
7. Examine Chains (sets Ambassadors free if you have Key). Use Pick. Go Passage. Don't head South.
8. Not sure why there's a Necklace, but what the heck, it's on the way back to the Lodge, just don't mess with the Yeti. (Code says that Drop Gourd, which contains a poison, would kill the Yeti, but enabling that feature is apparently left to the student as an exercise.)

EARTHQUAKE—SAN FRANCISCO, 1906

1. Get Wad of Bills. Look Dresser. Look Envelope. Get Letter. Look Letter and get your assignment. Letter may then be dropped.
2. Move Bed. Get Crowbar. (Earthquake hits shortly after you get it.)
3. Use Crowbar.
4. Look Wall. Get Handgun. Open Door. The fragile walls will soon fall, permitting you to Climb.
5. Look. Talk. Pay Owner. Get Apple.
6. Climb. Dig in Rubble. Get Gold Watch. Climb.
7. Bribe Soldier (need Watch). Climb.
8. Listen. Look. Climb. Look. Get Small Child. Climb. Look. Get Gold Key.
9. Look. Talk. Get Lumber.
10. Dig in Masonry. Unlock Iron Box (need Gold Key). Open it and Get Silver Key. Drop Gold Key.
11. Unlock Gate (need Silver Key). Open Gate. Leave Silver Key here—it's needed each time you wish to go through the gate.
12. Look Manhole. Lift Cover (need Crowbar). South. Look up. Look Light. Climb.
13. Look. Shoot Handgun (Shoot Gun or Shoot Soldier won't work). Look Soldier. Open Pack. Get Iron Nails.
14. Make Ladder—get a clue. Drop Apple, Iron Nails, Handgun, and Lumber for now. Head back and look for more goodies.
15. Look Wall. Get Hammer. (Note: Time at which Hammer will appear is a variable; seems to be better if you previously tried to Make Ladder.)
16. Look. Get Small Dog.

17. Make Ladder (need Ladder, Iron Nails, Hammer). Leave Handgun and Hammer.
18. After Dog relieves himself, Drop Dog. South. Look. Get Paddle. If you now have Wet Pants, don't drop them! OK to Drop Ladder.
19. Jump.
20. After Horse takes Apple, Climb on Horse. Ride Horse.
21. Look Crevice. Look Quartz. Look Impression. Look Flat Spot. Look Object. Get Diamond.
22. Open Door. (At first it may be too hot; move away some distance, return and try again.)
23. Sit Down. Eat Food. Get Fortune. Look Fortune. Drop it.
24. Like your Fortune says, go back to Iron Gate. Pull Gate. Get Iron Pole.
25. Vault (need Iron Pole). Iron Pole may now be dropped; needed only to Vault.
26. Cut Hole in Glass (need Diamond). Climb in Hole. Diamond is of no further use.
27. (Go back to Chinatown.) Look Iron Door. Talk. Get Brass Key.
28. Unlock Door (need Brass Key). Open Door.
29. Undress Woman. Get Green Dress.
30. Drop Little Dog. Let him dig a hole. Climb. (If he doesn't finish it fairly soon, meander back to Chinatown and return.)
31. Pry Boards (need Crowbar). Drop Green Dress, Wad of Bills and Paddle.
32. Drop everything that you are carrying. Climb.
33. Open Door. Get Green Dress, Wad of Bills and Paddle. Open Door.
34. Talk. (Need Green Dress.)
35. Talk. Climb.
36. Look around until boat sinks. Swim (three times—to large piece of wood). Climb.
37. Paddle (need Paddle) until the Soldier pulls you out. Talk. Climb.
38. At Porterman Hotel, Climb.
39. Talk. Pay Hampton. Your mission is over; your wife is free to go.

EMPIRE OF THE OVERMIND

General Note: Even though you may be carrying both a Key and a Pistol, for example, you can only use one at a time. That is, you must Hold Key or Hold Pistol first. The last object picked up is automatically the one being held. This, plus the one-move-only limit before creatures clobber you can make matters quite awkward.

1. Look for Gold Leaf, probably up a Tree.
2. Talk Man. Get Blanket.
3. Hold Waterskin. Fill Waterskin (at Brook). Don't enter *any* body of water until you are armed.
4. Holding Gold Leaf on entry, Dispel Skeleton (with Leaf). Get Key. Unlock Iron Door. After Getting Compass, Open and Go Window.
5. Look Astrolabe. (Transport to Red Planet.) For initial trip, should have Key, Blanket, Waterskin (filled) and Compass.
6. It is possible to avoid this area altogether. If you do come here, however, you will have to Drink Water.
7. Holding Key on entry, Unlock Door. Open Door. Go Door. Girl will follow you. Move away from the Green Alien as soon as possible, even if you have to return to enter the balance of these commands. Try dropping Blanket in Abandoned Bldg. with Empty Doorframe and leading Alien toward High Plateau, then "Wish" around him.
8. Kiss Girl. Talk Girl. Kiss Girl. Get Pistol and Black Box. Look Pistol. Push Gray Button. Carrying Key, Blanket, Waterskin, Pistol and Box, Hold Compass. Spin Compass. (Transport to Iron Stone on Blue Planet where balance of game will be played.) Carry what you can to Oasis. Drop Blanket and another item. Spin Compass back to Get Iron Stone. Get Blue Crystal. Wish back to Oasis.
9. Call Pyro. The Blue Crystal is now a permanent light source. If you don't have the Blue Crystal, Call Pyro will provide light for eight moves, and may be repeated twelve moves later, if necessary. Each summoning results in Pyro taking a random inventory object, which he will deposit on the Mountain Summit of the Blue Planet.
10. Look Grass to reveal a Secret Passage.
11. Clean Wall. Pick up Dwarf and go for the Bottle. Goblins regenerate, and Dwarf will only kill five before he abruptly runs off to sharpen his Axe. Use him while you Hold Key to Unlock Doors, but Hold Pistol whenever possible to keep Dwarf around.
12. Tie Kit. Climb Red Rope. Tie Kit (at Ledge). Climb Blue Rope.
13. Drop Blanket; you will want to return here quickly later on.
14. Holding Pistol, Shoot Wall.
15. Carrying Bottle (filled with Ale from Barrel), Blue Crystal, Pentagon and Holding Pistol, Shoot Wall. Hold Pentagon. Drink Ale (you will feel no pain for six moves). Go Hole. Dispel Demon (twice). Take Sphere. Wish. Drop Sphere and you and the Princess live happily ever after.

Transportation Summary

From	At	To	At	How
Blue Planet	Tower Roof	Red Planet	Lawn	Look Astrolabe
Red Planet	Cave	Blue Planet	Cave	Go Cave
Anywhere	Anywhere	Anywhere	Random	Gray Box
Anywhere	Anywhere	Blanket	Anywhere	Wish
Anywhere	Anywhere	Iron Stone	Anywhere	Spin Compass

Object List

Object	Where	Use
Gold Leaf	Tree top (usually)	Dispel/Animate (Skull/Cactus)
Waterskin	Brook (usually)	Water needed in all Deserts
Blanket	Cave near start	"Wish" zaps you to it
Iron Stone	Stone Quarry	Works with Compass
Compass	Wizard's Den	Spin zaps you to Iron Stone
Blue Crystal	Small Cave	Light Source (Call Pyro)
Key	Closet	Unlocks all doors
Xenon Pistol	Red Planet	Kill Creatures/Burning holes
Gray Box	Red Planet	Transportation
Mtn. Climbing Kit	Abandoned Bldgs.	Climb-at Window and Shaft
Pentagram	Abandoned Bldgs.	Dispel Demons (final phase)
Bottle	Dining Hall	Carries Liquid from Keg
Liquid from Keg	Store Room	No pain for six moves
Gold Sphere	Strange Place	Must be destroyed

The following objects are of no direct use:

Wood Stick	Black Stone	Scroll
Blue Sand	Red Sand	Red Herring
Bread	Bowl	Spoon
Dung	Straw	Gray Stone

ENCHANTER

1. Open Oven. Get Bread, Jug and Lantern.
2. Fill Jug. Good for four slugs—but then this game may drive you to drink.
3. Like the Signs say—Other Waayyyyyy!
4. Having gotten the Rezrov Spell from the Crone, Rezrov the Gate and Frotz the Lantern.
5. Open Door and Examine the Wall. Move the Block and get the Stained (Exex) Scroll. Read, Gnusto and Learn it, as you do with all (well, almost all) spells. Leave the Spoon.
6. Examine the Bedpost. Rezrov the Bedpost. Get Gold (Vaxum) Scroll. Clue is from dream that occurs if you're tired and sleep in the bed.
7. Leave Lantern (or your light source) outside. Take Lighted Portrait. Get Black (Ozmoo) Scroll.
8. Rezrov the Gate.
9. Nitfol the Frogs. Look Under Lily Pad. Get Damp (Cleesh) Scroll. Don't forget the Crumpled (Krebf) Scroll in the Forest. (You can sleep safely anywhere. Read your dreams carefully for clues.)
10. Rezrov the Egg. Take the Shredded (Summon) Scroll. Krebf the Shredded Scroll. Get the Faded (Zifmia) Scroll.
11. Save Game. Read the Dusty Book. Read Terror and Implementer for information. Examine Rat Tracks. Reach in Hole (rather fussy about syntax here). Get Frayed (Gondar) Scroll. If you have the time, Zifmia the Implementers, just for fun. Make sure that you know the Ozmoo and Rezrov Spells and head for the Temple.
12. When you're tossed in the Cell, Ozmoo Myself. Wait. Get the Ceremonial Dagger, the hard way. Down. Open South Door. You'll probably get flipped back up on the Altar, but your Ozmoo should still hold. Down. South. Get All. North. Head West.
13. Cut the Rope (with the Ceremonial Dagger). Open the Box. Get Vellum (Melbor) Scroll. Melbor Myself. You may now roam about with impunity.
14. Find the Adventurer in one of the Mirrored Halls. Zifmia the Adventurer. Vaxum the Adventurer. Show him the Egg (or Dagger) and he will follow you, at least for a while.
15. With the Adventurer lured there by the sight of your treasures, Adventurer, Open the Door. Get the Map, Pencil and Purple (Filfre) Scroll. Give the Adventurer the Egg, Dagger and Box if need be to lighten your load. Take the three objects from him if he has picked any of them up. Filfre the Room, just for fun, as you don't otherwise require it for the game.
16. Vaxum, Nitfol and Exex the Turtle. Turtle, Follow Me, and he will, for a while.
17. With the Turtle there, save the game. Turtle, SE and Get the Paper. Wave at the Turtle when he's in the Control Room. Get the Brittle (Kulcad) Scroll.
18. Save the game. Read the Map. Connect F and P. Erase F and P. Erase M and V. Connect M and P. Move to location P. Get Powerful (Guncho) Scroll. Drop Map and Pencil if necessary.
19. Make sure that you have learned the Vaxum and Gondar Spells. Save the game. Kulcad the Stairs. Read the Ornate (Izyuk) Scroll. Izyuk Myself.
20. Gondar the Dragon. Vaxum the Being. Guncho Krill. Congratulations on your 400 points and being admitted to the Circle of Enchanters.

The Spells of the Enchanter

Spell	Function	Description	Location
VAXUM	Make Hostile Creature Your Friend	Gold	Bedpost
ZIFMIA	Magically Summon a Being	Faded	Egg
OZMOO	Survive an Unnatural Death	Black	Gallery
EXEX	Make Things Move with Greater Speed	Stained	Cell
KREBF	Repair Willful Damage	Crumpled	Forest
CLEESH	Change a Creature to a Small Amphibian	Damp	Swamp
REZROV	Open Even Locked or Enchanted Objects	Some Sort	House
GNUSTO	Write a Magic Spell into the Spell Book	Initial	Spell Book
BLOBR	Safely Protect a Small Object	Initial	Spell Book
NITFO	Converse with Beasts in their Language	Initial	Spell Book
FROTZ	Cause Something to Give off Light	Initial	Spell Book
KULCAD	Dispels a Magic Spell	Brittle	Engine Room
MELBOR	Protect Caster from Evil Beings	Vellum	Box
FILFRE	Create Gratuitous Fireworks	Purple	Map Room
GUNCHO	Banish Victim to Another Plane	Powerful	Terror Room
GONDAR	Quench Open Flame	Frayed	Library
IZYUK	Fly Like a Bird	Ornate	Falling

ESCAPE FROM RUNGISTAN

1. In Cell, Read both Books. Call Guard. Food. Eat Steak. Move Bed. Under Window. Give Candy. Get Shovel. When Mouse appears, Drop Cheese. Get Mouse. Dig Hole in Wall (Not Floor).
2. Untie Rope from Gallows. Run. Jump. (Watch your timing.)
3. Do *not* push a key if Snake is on screen. Don't forget Knife.
4. Kill Bear. Read Carving. (Don't stick around or go East from the Cliffs.)
5. At Bridge, East. Jump West. (Hurry up!) Throw Rope. Cross Gorge. Start Part II.
6. Break Door. Get Skis. Save Game. Don't dally or you'll freeze. Say Geronimo. Good luck with the six or so sets of trees.
7. Look Tree. Get Canteen.
8. At Rebel, with Canteen filled from the River, Pour Water (on Dynamite). Take Dynamite.
9. Look Tree. Get Catcher's Mitt. Look Trunk for L7.
10. When Egg is dropped, Catch Egg (with Catcher's Mitt).
11. In Saloon, Look at Horns, and Register. Don't mess with Bottle. Syntax for opening safe is L14R21L7. Get Non-slippery Bottle. Leave Saloon.
12. Make Raft. Doors (of Saloon). Sail Raft. If you can't make it, you forgot to read Navigation Book in Jail. On to Side III.
13. In Farm area when hungry, Eat Egg (not Rutabaga). Help Farmer. Get Money.
14. Along Road or whenever Helicopter is seen, move back, away from it. Give Mouse. Get Glass.
15. At Observation Post, wait until Helicopter appears, then go West.
16. In the Pot (with Almanac), Predict Eclipse. Get Gas Tank. Buy Gas (with Money).
17. Gas Tank. With License and Grafitti message, Take Off. Fly N.E.S.S.E.N. (Sure hope you read the Book on Flying in Jail!) Push Button. Land Airplane.
18. At Blocked Road, Light Fuse (with Glass). Drop Dynamite. Move North.
19. At Border (toward "Prision" by the Sign), Give Booze. Lift Gate. Welcome to friendly Nuggyland.

ESCAPE FROM TRAAM

1. Just Look until you crash.
2. Look Ship. Get Nylon Rope. Move Ship. Get Laser.
3. Look Cliff. Look Bush. Throw Rope at Bush. Climb. At top, Untie Rope and take it along.
4. Look Tree. Get Frond.
5. West, until you Bump into an Object. Feel Object. Climb. Look Inscriptions (translates to the Alchemist). Dig with Frond. Get Stone Cup. Dig with Frond. Get Helmet.
6. Climb. On second pass through, Climb will cause a cave-in.
7. Look ship. Get Small Key (only after Body had Rolled Over).
8. Unlock Trunk (need Silver Key). Open Trunk. Get Dictionary. Read Dictionary. Get Alphabet. Look Alphabet. (Write it down and decipher Alien's words and those in the Stone Room.)
9. Fill Cup. Get Cup of Liquid.
10. Pour Cup of Liquid on Lead. Get Gold Ball.
11. Drop Gold Ball. Look. Climb. Talk to Creature many times, until he says to find someone.
12. Move Statue (three times). Look. Get Uniform.
13. Climb tree. Climb. Climb down tree.
14. Dig in Mound. Get Pendant.
15. Look Bush. Climb.
16. (Need Helmet.)
17. Push Pin.
18. Shoot Slave with Laser. Look. Get Uniform.
19. (Must Drop Pendant before entering, need Uniform.) Climb.
20. Kastaman.
21. Move Cabinet.
22. Look Shelves. Read Manual. Break Lock. Read Manual.
23. Drop Insect. Look. Look Crack. Move Block. Climb. Crawl. Crawl.
24. Tie Rope to Spike.
25. Like the Manual says, Unhook Auto Pressure. Lift Decoupling Ring. Push Thrust Bar.
26. Look Instruments. Push Button. Look.

G.F.S. SORCERESS

1. Go Ion Trail. Go to Bow of Ship. Remove Meteorite from Gun.
2. At Metallic Hatch, Open Metallic Hatch. Enter and close it. Open and Go Black Hatch.
3. Open and Go Red Hatch. Close Valve. Open Valve.
4. Go Shaft. Get Pistol. Check it. Push Violet Button. Like sign says, Don't drop it when armed.
5. Go outside Ship to Engine. Shoot Large Meteor. Return to Ship. Now you can get in Control Room (Blue Hatch) and briefly meet good old what's her name! (Selena Sakarov)
6. Push Blue Button on Console. Push White Button. Go hibernate in White Room. With Pistol, go out to Rigel X. Shoot Archway.
7. Get Silver Box (Robot Controller) and Gold Box (Translator). Command Robot to get White and Silver Books ("Robot Get Silver Book"). March Robot to Starship. Return to Control Room.
8. Push Green Button. Do the Engine Fire and hibernation bit. Step out on Epsilon Eridani V, again with Pistol. Go to the Depression in the Desert. Look Depression. Shoot Door.
9. The Sand Crab only threatens, doesn't attack; do *not* shoot him. Get Gold Nugget, but only if the first Crab isn't shot. Return to Control Room.
10. Push Orange Button. Start Engine and hibernate. Get out on Tau Ceti III with Golden Ankh from Bedroom. Put on Ankh. Climb Tree. Get sprayed so that Web may be gotten. The Quicksand is navigable, but Lizard would be missed. He is scared if Ankh isn't being worn. Return to Control Room.
11. Push Red Button. Start Engine and hibernate. Holding Silver and Gold Boxes, load up Robot with two books, Nugget and Pistol. March him out on Altair IV to the Hallway. Drop both books and Nugget.
12. March him into Small Room. Order Robot to Drop (Armed) Pistol. Drop the Silver Box and go to the Small Room, getting Nugget along the way.
13. Look Monolith. Give Nugget. Drop Web as soon as next Robot is seen. Back up and get books. Exchange White and Silver Books for Red and Black Books. Return to Control Room.
14. Push Yellow and White Buttons. If attacked by Pirates, Go Green Hatch and Push Black Button. Hibernate for the last time. Sit back and watch the conclusion.

GHOST TOWN

1. In the Telegraph Office, Move Safe. Splice Wires. (You can take them, but the game could never be won.) The coded message you may receive says Shake Topper.
2. Take the Shovel and Matches from the Dry Goods Store and Dig Manure. Get White Crystals. Take the Compass along, too, and look at it both before and when you get to the Horseshoe. Drop Compass. Mount Paint. Take Spurs. Spur Paint. Get up. Go Stable. Go Hole. Take Keg. Empty Keg by Ol' Paint. Take Keg.
3. Dig in Large Field and get Yellow Powder.
4. At the Impassible Ravine, Burn Sage (with Matches). Go Ravine. Drop Powder, Crystals, and Charcoal. Mix. Drop Keg. Fill Keg. With Gunpowder.
5. In the Mine, Light Match. Get Silver Bullet. Down. Get Candle. Light Candle. Down. Dig Roof. Get Gold Nugget. Haul the Keg back to the Telegraph Office.
6. After dumping the first load of Treasures, get the Bell from Saloon. Applaud the Piano Player if he's there. Check Piano for a clue you no longer need.
7. In Hotel, go behind the Counter and get Cash Box. In your Room, Ring Bell. Move Bed to Get Tape. When Sun goes down, Light Candle. Sleep *only* in bed.
8. In Saloon, Tape Mirror. Break Mirror, and get the Go-Board. Go back by night, when the Ghost is playing. Dance and Applaud. Get Silver Cup. If Ghost keeps getting scared, Unlight Candle and Dance in dark. When dropping off the Go-Board in the Dry Goods, say Pass Go.
9. Get the Stetson in the Barber Shop which has a Small Key in it. Take Horseshoe to Jail and Open Door (Use Horseshoe). Get Derringer and Hammer.
10. At Boot Hill, Shoot Snake with Derringer, and Dig with Shovel. Get the Gold Coin and fear not, this Purple Worm is not related to the one in *The Pyramid of Doom*. Not only is he easily squashed, but a small bonus rewards doing so.
11. Bring the Hammer, Nails and Horseshoe to Ol' Paint. Shoe Paint. Mount him and say Giddyup.
12. Get the Tom-Tom and Necklace. To get back, Beat Tom-Tom. Say How!
13. Jump the Ravine and go to the Line Shack.
14. Take Plank. Go Hole. Get Furs. Press Telegraph Key. Head for the Telegraph Office (that used to be) in town. Get Gold Dust. The treasure summary:

Cash Box
Go Board
Derringer
Necklace
Gold Dust

Silver Spurs
\$200
Gold Coin
Silver Bullet

Gold Nugget
Silver Cup
Tom-Tom
Furs

GOLDEN VOYAGE

1. Buy and Get everything in the City with the King's Gold.
2. Raise Anchor. Sail West. Leave Compass on Deck. Take Telescope to Mast top. Look Telescope. (This is also required on the first trip to the other two islands.) Drop Anchor. Wear Sandals. Go Island. Get Box and Shovel. Sword isn't necessary.
3. Sail to Rocky Strand. When Statue animates, Go Staircase. Push Statue. Walk Down. Search Rubble and Get Stone. Dig for Key on Grassy Plain.
4. Go Stairway. Get Steel. Walk Up. Look Altar. Leave Chalice for now. Unlock Chest (with Key). Leave Mask and Small Stone for now. At Altar—Pray.
5. Sail to Sandy Beach. Give Medicine (in Box) to Man. Get Clue. Dig in Jungle and Get Rope. Dig (twice) by Cave and Get Torch and Stone. Light Torch (with Steel).
6. At Fountain, Put Tablet. In Fountain. Dig outside Cave for second Torch (unnecessary).
7. Sail to Rocky Strand. Drop three Stones in Hidden Chamber. Get the Sun Tablet. Head for Small Island.
8. At Grass Hut, Hold Tablet and Say Sun. Go Crevice. Put Sun Tablet. In Fountain. Look Fountain. Get Globe. Return to Rocky Strand.
9. At Damp Grotto, Tie Rope. To Stalagmite. Drop Rope. Climb Rope.
10. Wear Mask. At Cyclops, throw Globe. Go Cave. Fill Chalice. Save Game. (Cyclops, in his blind frenzy, is likely to stomp you.) Return to King. Give Chalice.

GRUDS IN SPACE

1. To maneuver in space, Type (Navigation coordinates) on Bridge or at Auxiliary Navigation Console. Then Type (Teleport coordinates) at Teleport Room.
2. Steal Rope. Move away immediately.
3. Get Coin from the one Grud guarding a cave. Knock. Yes. Give Coin. Follow Deebo to Living Room. Get Flashlight, Note and Venus coordinates.
4. Head for Venus, ignoring the Alien Ship for now. Tie Rope To Tree. East. Down. Get Gun. Untie and Take Rope on way out.
5. Shoot Venusian. Will only stun him.
6. Drop Gun before approaching Mr. Green. Give Note. Get Money Maker. Shoot Venusian on way out, too, or else!
7. Back on Saturn, Tie Rope to Stalagmite. Down. Find the Key.
8. Shoot Bat (need Gun). Up. Unlock Box (need Key). Get (second) Key.
9. Give Money Maker (to Deebo). Get Rock in return.
10. Unlock Gate. Drop the two keys. Go Get Green Orb in Temple.
11. Drop Green. Get Blue and Green Orbs (Get All).
12. Use Orbs like keys in matching colored holes. Be sure to Get (color) as soon as you've dropped it. Go East and North of your Time Window. Get Orange Orb. Work your way to the East, Get Purple Orb. Go back past the Time Window, and Get White Orb. Return to the Southeast end and Get Yellow Orb. Drop the Blue and Green Orbs at the Time Window. Go West and South to get the Brown Orb. Finally, Get Black Orb in the Northeast corner. When you leave, drop all Orbs except the Black Orb.
13. Break Table. Take Leg.
14. Buy H-Container (need Rock). Get one and change. Buy O2 Mask.
15. Shoot Arler (need Gun, and should have H-Container).
16. Drop Black Orb. Visit Arler. Look Screen. Get the word on the Fuel.
17. Move Rock (need Leg). Get Fuel. Revisit Arler's Den, get Note.
18. Give Note to Deebo. Get Card. Head for Saturn again.
19. Shoot Tree.
20. Look Tree. Insert Card. Revive Mr. Green (need O2 Mask). Get Titan coordinates. Push Blue Button. Head onward to Titan.
21. Get the Bomb and the Remote Control Box—that's it for here. Check the message waiting for you in your ship, get coordinates for Pluto.
22. Drop Bomb. Go Window. Push Red Button.
23. Pull Lever. North. Give Fuel.
24. Go to Earth and collect your million bucks and bunches of thanks.

INFIDEL

1. After getting up, collect all objects at the Fire Pit, Work Tent, and Supply Tent. Break Lock on Chest with Axe. Remove and Drop Lock. Open Chest. Get Map and Beef. At the Nile, Drop Knapsack. Open, Fill and Close Canteen. When you get hungry, have water close at hand. The Knapsack can carry many objects, obviating an inventory management problem, but at the cost of having to drop them to get at any of the contents, and, perhaps, forgetting to pick them up again.
2. Open Crate that the Plane dropped. Get Navigation Box. Push Button to get your latitude and longitude. Use the Box to find the location marked on the Map that came with your game. Dig with the Shovel until you uncover the top of the Pyramid. Unfold the Map and Put the Cube in the Hole. Check the Hieroglyphics.
3. Get Torch. Open Jar and Dip Torch in it. Drop Knap and get Matchbook. Take Match and Close Matchbook. Light Torch with Match. Close and Take Jar. (Torch may require this procedure during game; extinguish it before dipping.) Tie Rope to Altar. Take and Throw Rope to North. Take Knap. Go either North or Down.
4. Move Statue. Take Head and Gold Cluster. Roll Statue Northeast (for example), Drop the Head (to match your weight on the floor). Go Southwest to the Room of Isis and Get Emerald Cluster. Get the Head and Roll Statue into another diagonal corner, moving in the opposite direction until you've gotten all four jeweled Clusters. Note the Hieroglyphics in each room; they differ but slightly, offering a clue to their decipherment. (Hint: a "direction" and name appear in each.)
5. Compare the Scroll Hieroglyphics to those in one of the Cube rooms; note what may well be the numbers one through nine.
6. Examine Slot and Remove Shim. Put Torch in Knothole. Now it's safe to Drop All. Lift Mast. Get All. Go up and Get Beam (Mast), noting its Hieroglyph.
7. Examine the Dead Adventurer for the (Poison) Ring. Save the game and Wear Ring. Deciphering the Chamber or the Silver or Gold Room Hieroglyphics here would give away too much! Be content by getting the Gold and the Silver Chalice.
8. Take and Drop First, Third, then Fifth Brick, just like the Scroll "tells" you to do.
9. Break Plaster with Axe.
10. Place the Mast in the Niches, like the Hieroglyphics there tell you to do. Stand on the Beam. Break Plaster with Axe. Open Door.
11. You need the Mast again. Put the Mast between the rocks. Open Door.
12. Put the jeweled Clusters in their appropriate corners to match up with the God's rooms in which they were initially found, Diamond in First, Ruby in Second, Emerald in Third, and Opal in Fourth. Be sure to take your Knapsack. Lift Slab. Get Book and Spatula. Read Book, noting its Hieroglyph. Open Book with Spatula for a little more easy reading! Take Beam when you've left.
13. Put the Beam under the Timber. Examine the Door and Break the Seal with the Axe. Open Door.
14. Put the Gold and Silver Chalice on the two empty discs on the left and on the right. Pour Water into the Silver Chalice, or as an alternate, put the Cigarette Pack in the Silver Chalice. This will balance the scales, and permit you to Get the Scarab. Note its Hieroglyph.
15. Place the Book in the Large Recess of the Queen's Sarcophagus, and the Scarab in the Small Recess. (This is a direct translation of the Hieroglyphics in the Book.) Turn the Gods in the order implied by the number of "@" in each of their names, that is, Neith, Selkis, Isis, and Nephthys. When you now move the lid, you have won 400 points but lost something else. Yes, this is the end, there is no other way of getting a perfect score, and no way of avoiding this ending. You can, however, by using the beam to cross the Pit, get out of the pyramid with 395 points.

KABUL SPY

1. Buy Ticket (for Bus at 8 Rubles). Get Matches.
2. Give Ticket (to Bus driver).
3. Drop all Objects except Money. West. Get Mugged. (They leave Money Belt, but take everything else.)
4. Look Dirt. Bribe Guard. Give Guard 215 Rubles. Prison's name is TARSIDAN.
5. Buy Ticket to Quetta (40 Rubles). NE Border is also 40 Rubles, but you can't win that way.
6. Move Bed. Get and Read Newspaper. KOJA means Where. KOMAK means Help. SALAM ALEIKOM means Hello.
7. Kid wants 100 Rubles, will take 10. Note you must have a minimum of 27 Rubles for later. Go West. South. West. Boy's Note says East, North, East, which is the way he got here from there.
8. Say Go To Hell.
9. Say KOJA HISRIN (where's Hisrin?).
10. Shoot Priest (or he'll have you Mugged at the River). Return to Bar.
11. Say KOJA (to Hisrin). SHOMAL means North.
12. Light Cigarette. North. Save Game. (Cigarette may go out before you can use it.)
13. Light Lamp with Lit Cigarette. Get Keys.
14. Welcome to the Original Adventure! Get Necklace. Say XYZZY and teleport to Inside Building. You'll need Knife, Keys, Money, Rod, and Lamp.
15. Buy Staff. Offer 20. Buy Photo. Drop Belt. Staff needed to traverse Trails North of City. If you're broke here, Sally will get you home to start over.
16. Iranian Commo Camp may be visited with Picture. Good for 20 points, but no other bearing on game. Leave and Drop Picture.
17. Get Silver Bar. Rebel can be shot, or you have two or so moves to get in and get out.
18. Get Gold. The Word is SUIRIS. Two or so moves and Chomp!
19. Ask (Dying) Man. Unlock Tank. This area is a good place to temporarily leave objects and treasures. Add Oil and Wirecutters to pile.
20. Get Rifle and Diamonds. Check out the Map. (Look Map.)
21. Erase Bridge.
22. Say KOJA TARSIDAN (to Bartender). MAHGREB means West. Going West now shows a path to North that wasn't there before.
23. Drop Rod. Get Shovel.
24. From Edge of Minefield and using Dagger as the Probe, North (into Minefield). N.E.E.N.N.E.N.E.E.N.E. Get Bullet for Rifle. No need to load Rifle.
25. To Outer Fence from Jeep, West (into Minefield). N.W.W.N.N.W.W.W.N.N. Cut Fence (with Wirecutters).
26. Shoot Guard. Dig (with Shovel). North to Messhall. Get Bars. Professor will follow you, but won't talk. You cannot open the Trapdoor from the Messhall side. There are two ways to get the Professor. Either one can result in achieving your primary mission; you must go both ways if you are playing for points.

KABUL SPY (continued)

27. The second way of getting him starts at the Iron Door. Say SUIRIS. Get Emerald.
28. Put Oil on Rust. Open Door.
29. If you went here before doing the mine field bit, sure hope you have the shovel!
30. Smoke Grass. Get Device to East.
31. Reset Gate.
32. Put Device on Canopy. Go MIG.
33. Close Canopy. Fly MIG. Get your score and number of moves. There are 700 points available, but in the game as played above, there are still 50 points lurking about, as you will get 650.

LABYRINTH OF CRETE

Part I

1. Separate and go around.
2. Chop Bridge with Ax, Get Boards.
3. At Bridge, Drop Worms, Get Turtle.
4. Give Hermes the Turtle, Get Lyre.
5. Give Apollo the Lyre, Get Fire.
6. Burn the Plank.
7. Burn the Hydra.
8. At Obelisk, Climb Hercules, get Rose.
9. At Sphinx, Say Man.
10. Give Eros the Rose, Get Bow and Arrow. (Give the Coin to Phineas for a clue.)
11. Shoot Harpies, Get Talisman from Phineas.
12. Drop Talisman by Dove, Get Dove.
13. Dove will calm the clashing rocks.
14. Separate. Jason to Castle; Hercules to Atlas, hold Earth. Get Golden Apple.
15. Tell Hera "Atlas" to free Hercules.
16. Hercules holds Cerberus. Jason gets by, and Hercules can then follow.
17. Give Charon the apple, get word "DNECSED."

Part II

18. Get Wooden Bowl from the children.
19. Look at the Fire, Speak to Theseus.
20. Fill Bowl at River Lethe.
21. Look at the Myrtle, Get Seeds.
22. At Elysian Fields, Drop Seeds, Get Fruit.
23. At Poverty, Give Water, Get Fruit back.
24. At Hunger, Give Fruit, Tantalus freed.
25. Get clue from Tantalus.
26. Have Jason speak to Rhadamanthus.
27. Get "stoned" Jason; Get Whip from Tisiphone.
28. At Condemned Titans, Use Whip, Get Fire.
29. At Hydra, Drop Fire.
30. Get candle in Hallway, and speak to Fates.
31. At Sunken Rock, Drop Statue (Jason).
32. Whip Griffin, Get Hope Jewel.
33. Separate, one at Lord Hades, other at Ixion.
34. At Ixion, Drop Jewel, Get Pandora's Box.
35. At Disease, Drop Box, explore balance.
36. At City, Drop feathers and candle, Get Wings.
37. From Canyon, Fly up to Part III.

Part III

38. At Oceanus, Drop Idol, Get Trident.
39. At Sparkling Cave, Drop Trident, Get Ore.
40. At Forge, (Part II), Drop ore, Get shield.
41. With Wine Cup, at Crude Shaft, separate; Jason enters Chamber, Get Ambrosia.
42. Give Ambrosia to Bacchus for clue. (Nectar from Part II also works.)
43. Say Theseus to Ariadne, Get Ring.
44. At Castle, Jason touches Midas, Get Gold.
45. At River, Drop Gold, restore Jason, get clue.
46. At Cavern, "Free Dagger," Get Dagger.
47. Kill Medusa, watch Pegasus fly away.
48. Give Athena Medusa's head, Get Girdle.
49. At Chamber, Drop Girdle to find Pegasus.
50. At Vault, one gets killed, Get Vial.
51. At Golden Fleece, Open (Free) Serpent's Teeth.
52. At Forest, Get (Free) Serpent's Teeth.
53. At Vault with Fleece, Say "YRECROS," Get buddy.
54. (Part II) At Shore, Drop Teeth.
55. (Part II) At Shore, with flat stone, Kill Skeletons, Get word "YRECROS."
56. (Part I) At Cave, Drop Ring, Get Sword.
57. Kill Minotaur at Labyrinth End.
58. Give Fleece to Zeus—ascend to Olympus.

MADVENTURE

1. Read Book. Light Lamp. Deposit Key, Crowbar, Bottle, Book and Lamp (in Chute).
2. Eat Sandwich. Go Hole. You'll get squashed if you're carrying anything.
3. Read Book. Eat Key. There are two more important clues in the book which will appear in due course. Keep checking.
4. My vote for the best one-command puzzle in all Adventuredom. So simple, so obvious, so difficult, so Take Fork!
5. Drop Bottle. Get Ball. Throw Ball. Get Kewpie Doll.
6. Use Fork. Get Diamond. Back.
7. Take Shell. Get Fork. Drop Shell. Drop Fork at Checkpoint.
8. Give Doll (to Beggar). Beggar only appears once. The key words in his clue are "On and Off."
9. Use Crowbar. Drop Crowbar. Get Earring, Pewter, Pearl and Crystal.
10. Clean Rocks. Say KATIE. Drop first load of treasures. KATIE will return you underground.
11. Climb Ivy for five points. The Stick isn't needed.
12. Can enter only with Ruby and Book. Leave Book for fifteen points.
13. Lamp Off. (Recall the Beggar's words.)
14. Get Coin and don't forget (or Eat) Candy, as it's worth fifteen points. Entering Lobby is good for ten points.
15. Say PLUM (Hint was in Book). Say KATIE. Get Revolver. The effect of magic words changes a bit if you're carrying the Ruby. This approach also gets the Book to the Library in a move-efficient manner.
16. Pet Cat. Teleport to Catwalk.
17. Get Spoon. Go Mirror. Find Emerald in Maze. Exit from Pit in Maze. It's the only way to get Ruby out.
18. Get Fork. Get another Kewpie Doll. Get Jewel.
19. Drop all treasures off in the Lobby. With careful planning, and using KATIE and PLUM from the beginning, the game can be completed in 181 moves, assuming no saves, inventories or errors. Don't mess with Sandwich or bother to Read Book.

MASK OF THE SUN

1. After Leaving Plane and Getting in Jeep, drive to Hut. Get food from Jeep. Get out, and Enter Hut. Give Food to Old Woman. Get Flute. Leave.
2. At Clearing, learn word XOTZIL. Get out of Jeep. Drop All But Pills. Put Head on Statue. *Never* drop until you have Mask.
3. At Northwest Pyramid, Take Rope and Lantern from Jeep. Light Lamp. Enter Pyramid. Shoot Snake. (As soon as Snake appears, push a key. Snake will strike when the “clock” that he just started runs out.)
4. Search Platform. Open (Hidden) Door. Get Jade Bowl. Drop to basement. You can get to Basement from Pit, but would never get the first Bowl—a bummer.
5. Ask Apparition. Get clue. Get Gold Bowl.
6. Hit Skeleton With Amulet. Get Silver Bowl.
7. Put Urn on Right Pedestal. Door opens. Go back to Jeep. Note: Rest of this Pyramid and all of the five room jobber to Southwest has no bearing on solving the game.
8. The Southwest Temple (Side 2) and all contents are not in-line to the game. It’s all for the clue that these are two Masks. Search Door. Get Gold Key. Unlock Door (where the Block is) With Gold Key. (You may also Move Block. Get (useless) Black Key. Cut Web.) Path to Pool through Maze is Forward. Left. Forward. Right. Look Pool.
9. At Northwest Temple (Side 2), Go Hole. Get clue from corpse. Save game at this point.
10. In Gas Room, depart immediately to Southwest. Sayonara Raoul. Good luck in jumping over the Lava Pit.
11. At Two Stone Idols, Say XOTZIL. Note: To left is Dark Pit, can get out by pounding around for a while. To right is Maze, needed like a hole in the head.
12. In Mask Room, Look at Carving. Put Amulet on Altar. Take Mask. Search Altar. Find *real* Mask (first one now disappears). The disease is now cured; you can drop Pills. Wear Mask to find exit.
13. The answers to two of the three riddles are Fire and Man. You only need one, so forget the other. If you blow the answer, you get dumped into the Black Pit. Beat on keyboard a while to get second/third shot.
14. From Maze 1 entry, Right, Left, Left, Left. Forward to Mirage or Right to Falling Room. Enter Maze 2 from Falling Room.
15. Maze 2 is a key-pounding, fifty-two location, slow section. Don’t bother mapping. Regardless of direction chosen, you get to the identical location. Sometime after the seventy-fifth move, Roboff will appear; save game immediately.
16. Give Mask to Roboff. Play Flute. Watch the fireworks.

MISSION: ASTEROID

1. Open Door. Go Door.
2. Look Watch. Push Switch. Starstruck. (Note: Each move takes five minutes.)
3. Salute General. (Brass can get up-tight about the darndest things!)
4. Get and Insert Diskette. Into Computer. Write down the Flight Plan.
5. Open Door. No sweat to pass Preflight Physical if you Exercise and Take Shower. (Sounds like my doctor.)
6. Push Blue Button. Blue opens North hatch, closes South hatch and raises the ladder. Orange is the reverse.
7. Look Console. Read (and write down) Console Sign regarding Rocket Operation. Combine with Flight Plan to come up with: Push Throttle. Push (Blue, Black, Orange, White, White, White, Blue, White, Orange, Orange) Button. Pull Throttle.
8. Get Spacesuit. Wear Spacesuit. Don't Turn Dial until you are in Vacuum Lock; air is limited. (Note: The Violet Button closes door behind the Console. It need never be pushed as it slows you down when time is critical.)
9. Read Watch. If it's later than 5:05 PM, it won't reach, so start over. Set Timer. 120 Minutes. Drop Explosive. In Pit.
10. Return to Earth by: Push Throttle. Push (Blue, Blue, Black, Orange, Black, Black, Black, Blue, White, White) Button. Pull Throttle. Things are cool if you're on Earth when the explosives go off at 7:15 PM.

MISSION IMPOSSIBLE

1. Sit Down in Chair. Push Red (arms bomb). Push White (disarms bomb). Get Up. Get Visitor's Badge. (Door sequence is White, Yellow, Blue.)
2. When Thud sounds, find and Frisk Saboteur. Take body and badge to White Room.
3. At White Room Door, Show Visitor's Badge.
4. Break Glass with Recorder. With Saboteur's Badge and body, show Badge. Get Yellow Key on Ledge. Return to Chair.
5. Unlock Yellow. Push Yellow. Push Red. Push White. Get Maintenance Badge.
6. At Yellow Room Door, Show Badge. Shake Mop for Blue Key.
7. In Chair with Blue Key. Unlock. Push Blue. Push Red. Push White. Get Security Badge.
8. At Blue Room Door, Show Badge. Take Water. Get Suit. Kick Plain Door. Leave Water in Break Room.
9. To see movie, Install Control Room Film in Projection Booth and go to White Visitor's Room. Push Green.
10. In Control Room, Wear Suit.
11. With Cutter, Cut Red Wire. Take Bomb to Break Room as soon as possible.
12. Drop Bomb. Take Water. Pour Water.

MUMMY'S CURSE

1. No puzzles, but a few traps. Don't leave without Flashlight, Gold Coins, Matches and Ewer (with Liquid). Be sure to Drink Water whenever you pass the Oasis.
2. (Need Flashlight.) Write down Amulet meanings: HORUS=Strength; APEP=Snake; SMA=Lung.
3. Buy Knife and Shovel.
4. Dig (with Shovel).
5. Burn Incense (from behind Stone Altar, where you got the SMA).
6. Say Hello.
7. Pour Liquid.
8. Pick Door (need Knife).
9. Use HORUS. (North.)
10. Use APEP. (North.)
11. Carve Key (need Knife and Stick). North.
12. Make Rope (need Hemp). Cut Trees (need Axe). Get Logs. Make Raft.
13. Use Raft.
14. Use SMA.
15. Wave Sceptre (rise in air). You automatically get Mask.
16. Keep Working. Try a few directions until Mummy kills you. Say "Y" to the question about replaying. You are returned to the Oasis, but with the Mask. Thus, though you were killed off, you win!

MYSTERY FUN HOUSE

1. To get in, Get Branch in Parking Lot. Chew Gum. Stick Gum. On Branch. Look Grate. Stick Coin. Go buy a ticket.
2. Get Spectacles from Shooting Gallery. With them, you can find a hidden door at the Mirror Room. Get Valve Handle.
3. With the Valve Handle and the Trampoline from the Small Room, Go Ladder. Turn Valve. Jump Up.
4. After getting the Comb and Match, exit by a Roll.
5. Go Slide. Get Key. Give Comb. Don't mess with the Drain Valve. Go Stairs.
6. In Large Room, Merry-Go-Round must have been turned off by the Valve. Push Blue to stop Merry-Go-Round. Go Merry-Go-Round. Ride Horse. Climb Pole. Look Up. Climb Rope. Don't mess with the Red Button. Get Wrench. Open Door with Key. Get Flashlight.
7. At the Rusty Grate in the Parking Lot, Remove Bolt with Wrench. Move Grate. Have the Flashlight and the Match handy.
8. At Sewer System, look in Heel, if you haven't already done so. Chew Gum. Stick Gum. On Fuse. Stick Gum. On Grate. Light Match. Light Fuse. Didn't work, did it! Well, Close the Door, dummy!
9. On the return leg of Step 5, the Out-of-Order Sign from the Vending Machine should have been hung in the Shooting Gallery.

MYSTERY HOUSE

1. Go Steps. Open and Go Door.
2. With the Hammer from the Attic and the Candle from the Dining Room, Open and Look Cabinet. Get Matches. Open and Look Refrigerator. Get Pitcher. Look Sink. Get Butterknife. Water On. Get Water. Move Cabinet. Break Wall (with Sledgehammer).
3. With Lit Candle, try leaving. Pour Water. Look Hole. Get Key.
4. After Getting Towel, try to Get Picture. With Lit Candle, try to Get Picture. Unscrew Bolts. With Butterknife. Get Picture. Press Button. Go Wall.
5. Wipe Algae. Get Brick. Get Jewels. Get Key.
6. Look Telescope. (Permits you to see Hidden Trapdoor).
7. Unlock and Look Trunk. Get Pistol. Go Door. Open Trapdoor. Go Trapdoor.
8. Kill Daisy. With Pistol. Exit via front door (with the Skeleton Key) and become a Guru Wizard.

OLDORF'S REVENGE (WIZARD I)

1. Select a Thief as your original character. Unlock Door. Down. Get the ten gold pieces U and D from the Junction.
2. Change to an Elf. Down. As a Cleric, Translate. Gold. Get five Gold Coins.
3. As Wizard, Cast. Get Sword.
4. Still as a Wizard, Cast to open Spun Glass barrier.
5. Still as a Wizard, Cast away the Snake.
6. As Magician, ZPWW. Get five Gold Coins.
7. As Strongman, Move. Get five Gold Coins.
8. As Elf, Down for five Gold Coins.
9. As Gladiator, Attack (twice). Down for five Gold Pieces. You may now cross Bridge, but must have fifty Gold Coins to do so. Your count on remaining characters should be all fours, except for three Elves.
10. As Cleric, Read. Get word Shazam.
11. As Magician, Shazam. Get Skeleton Key.
12. As Thief, Unlock Coffin (need Key). Get Ring.
13. As Cleric, Read Books (need Ring). Malanthius. Get a Door and a Book.
14. As Strongman, (U)p. Get five Gold Coins. Go Down twice for next phase. Your character count should not be worse than 2,3,4,3,3,4.
15. As Wizard, Cast to lower Drawbridge.
16. 1666 (i.e., MDCLXVI in Roman numerals). Get Sceptre.
17. As Wizard, Cast to get rid of Sentry. You can go North and South three times to get all three Mushrooms, but you'd eventually regret it. Take only one, like the Possession Limit says.
18. As Strongman, Move Table. Move Chair. Get Cross. Bar of Gold is next door.
19. As Cleric, Listen. As Strongman, Move (repeat until it's gone). Down to Get Diamond. Go on to next phase. Your suggested character count should be no worse than 1,3,4,1,3,3,3.
20. Either as Gladiator, Kill, or as Wizard, Cast.
21. As Wizard, Cast. Then as Magician, Magic.
22. As Magician, Magic. Down and Get Tiny Key.
23. As Wizard, Cast. Get Lynxor's Treasure. Don't forget the fifteen Gold Coins.
24. As Cleric, ZELOT (Tolez, spelled backwards). Get ten Gold Coins.
25. As Thief, Unlock Door (need Small Key).
26. As Strongman, Move (repeat until all are moved). Get Necklace. Move (again), so you can get out later. As Elf, Down for ten Gold Coins.
27. As Wizard, Cast twice, and once more to the West. Get Ickyup's Ruby Treasure.

28. Still as Wizard, Cast to get the last of the Gold. At Special Junction 3, (X)it the game and be advised that you are a "Grand Exalted Whiz Bang All Time Poobah Wizard and a Nice Person!" You should also have 300 points from the following items.

55 Gold Coins	Large Diamond
Valuable Book	Gold Bar
Powerful Sword	Onyx's Sceptre
Skeleton Key	Tiny Key
Oldorf's Ring	Ickyup's Ruby Fortune
Magic Mushroom	Zit's Necklace
Valuable Cross	Lynxor's Treasure

OO-TOPOS

Note: I found it difficult to detail a solution to this game. I noted discrete puzzle solutions, but the main task is to collect the forty-five or so objects and haul them to the Hull of the spaceship, some 142 rooms later. Property management is a major task. You should use several intermediate dumping points to minimize a lot of running around.

1. Get Laser. Shoot Alien.
2. Catch Snarl (with Cage).
3. Pour Flask. Fill Flask (in Acid Room). Pour Flask.
4. Release Snarl. Get Gyro.
5. CROND teleports between here and East End of Wide Tunnel, a good place to collect objects.
6. Get Goggles. Wear Goggles. Look. Get Axe. Chop Partition.
7. Get Dart. Throw Dart. Need Translator to read the Plaque.
8. Get Cylinder (need to Wear Gloves).
9. Get Phase Shifter (need to Wear Gloves and have Field Nullifier).
10. Wear Goggles. Look. Get Jewel.
11. Fill Flask at Pool of Water. Pour Water. Collect any stolen treasures from Stockpile Room. Note: The effect of the Water wears off after a number of moves, so refill the flask and keep it nearby.
12. TAKA<->LEVA teleports between here and the Crimson Beach, two locations North of the Hull. Get Wrench (Wear Goggles).
13. Get Pouch. Kill Crabbette (with Pouch). May have to pick up Pouch again, and keep trying at next Beach location as your luck (and Crabs, too) is randomized.
14. TUGO-TUSTA teleports between here and Solarium.
15. Get Needler. Shoot Gras. Get Chest (Wear Suit and Gloves).
16. Open Box (Wear Goggles). Get Compass.
17. Search Trash for 6502 Chip.
18. Feed Huja (need Tiny Seeds, he won't eat the Freeze Dried stuff). Get Navigation Chip.

19. With all spaceship parts by the Hull, Wear Goggles. Get Wrench and Manual. Build Ship. Haul all objects into the Storage Hold. (Enter Ship.)
20. At Bridge, Up. N.N.W.N. Unload the Hold. Type Score. Don't know the maximum score; my best was 130.

Spaceship Parts

Tachron Power Cylinder
 Gyroscope
 Oxygen Recirculator
 Seamless Box (Compass)
 Navigation Chip
 Repair Manual
 Converter
 Water System

Weapons

Laser
 Dart
 Needler
 Seeds (sort of)

Useful Objects

Goggles
 Vibroaxe
 Gloves
 Pressure Suit
 Flask (Acid/Water)
 Cage (for Snarl)
 Field Nullifier
 Light Rod
 Translator (sort of)
 Plaque (Ticket)

Other Stuff

Food Packet
 6502 Chip
 Jade Seahorse

Treasures

Small Ring
 Library Crystal
 Plasma Sphere
 Vega Silver
 Psi Cube
 Elixir Energy
 Double Helix Healer
 Atom Transmuter
 Emerald Flower
 Terran Relics
 Harmonica
 Ruby Seashell
 4-D Mirror
 Betamax Cassette
 Moon Jewel
 Rainbow Cloth

PALACE IN THUNDERLAND

1. Open Clock. Drop Mouse (from Kitchen). Now the flashlight will provide fifteen turns, rather than six, before it runs down. Six won't do the job.
2. Get Package. Open Package later (with Shears). Get Ermine Robe.
3. Get Drumsticks. Wave Sword in each room, sometimes fun, sometimes clues. Try it here. Get Gold Record. Get Hairloom en route to Landing.
4. Turn Bed. Get Tag. Get Key. Drop Tag. Leave Package and Gold Record in Storeroom.
5. Unlock Door (with Key). Get Shears. Get Flashlight and Jugs on way back. .
6. Open Vial. Rub Medicine. Look Mirror. Cut Hair (with Shears). Weave Hair. Get Hair Net. Leave Hairloom in Storeroom. Open Package now (with Shears). (The clue to the hair sequence comes from Waving Sword in Parlor.)
7. Penny appears only after the lights go out. (Flashlight On.) Be near here at twentieth move after Thunderstorm starts.
8. You can Kill Jabberwocky (With Sword), but then you've got a no-win game on your hands. Try "Catch Jabberwocky" (with Hairnet). Get and Wear Boots.
9. Wearing Boots and with Flashlight and Penny, Open Box. Insert Penny. Let there be light!
10. Give Jug (to Carpenter). Get Prybar. Carpenter will follow you.
11. Walrus and Carpenter, get it? Open Oyster (with Prybar). Get Pearl.
12. Drop Jabberwocky. Get Sceptre.
13. Move Rack. Get Chateau Lafcet. (Carpenter will swill that too if you are dumb enough to let him.) Say Inspector. Get Diamond. (Clue is in Pink Guest Room.)
14. Say Seebone. (Like Sword says.) Get Spikey Ball (Hedgehog).
15. Put Globe, Duster, Drumsticks and Prybar in Mingo Mender. Get Flamingo.
16. Say Revolt. Get Crown. Have fun with Drop Ball. Hit Ball (with Flamingo).
17. Drop balance of treasures in Storeroom. Wear Robe and Crown. Take Sceptre. Go to Top of Turret. Wave. Drop everything in Storeroom. Go down to Courtyard for finale.

PIRATE ADVENTURE

1. Take Book (Opens Book Case). Read Book. Open Book (twice). Go Passage. Get Bag and Torch.
2. On Ledge, Wear Sneakers and with Book, Say Yoho.
3. Give Pirate Rum. Get Chest on way back; leave it on beach. Parrot will stay if you have Crackers. (Dropping Sneakers and Book on Beach will minimize the inventory management problem.)
4. Matches for Lamp are in Bag. Get Hammer and Wings. Leave balance for now. Return to London Flat.
5. Pull Nails with Hammer. Get Nails and Keys. Get empty Bottle and Wake Pirate in the Musty Attic. Return to Sandy Beach.
6. Open Chest and look twice. Get Plans and Map. Wearing Water Wings and with empty Bottle, go in Ocean and fill Bottle. Catch Fish.
7. Take the Torch and Matches. Give Fish to Crocodiles. Get Lumber, Shovel and Sails.
8. With Shovel, Get Anchor.
9. On Beach, Build Ship. Plans say what you need.
10. Board Ship. Raise Anchor. Set Sail.
11. On Beach, Dig. Get Rum. Give to Pirate.
12. In Monastery, Release Bird. Get Dubbleons.
13. In Barren Field with Hammer and Shovel, Walk 30. Dig. Open Box. Get Stamps.
14. Wake Pirate. Return to London Flat. Drop both Treasures, say Score.

PLANETFALL

1. Nothing really can be done until the explosion occurs. Enter Pod. Get in the Web. Wait until Pod lands. Get out of Web. Get Kit. Open Bulkhead. Leave Pod. Swim Up.
2. Look at Crevice. Hold Metal Bar Near Key. It's magnetic, so don't carry it when you have any of the Access Cards.
3. Search Robot. Get Upper Elevator Card. Turn on Robot. You could turn him off later to get it, or Floyd will eventually volunteer that he has one.
4. Open Lock With Key. Remove and Drop Lock. Open Door. Get Ladder. Leave the Can and Key.
5. Drop and Extend the Ladder. Put Ladder Across the Rift.
6. Look at the Desks in both Offices. Open Drawers and Get the three Cards.
7. Slide Kitchen Card Through Slot.
8. Examine Machine. Open Canteen and Put it Under the Spout. Press Button. Close Canteen or Drink the Liquid if/when you are hungry. Carry a full canteen with you.
9. All you need from here is the Bedistor.
10. This area is a red herring with no bearing on the game. Ditto for the Dorms and Sanitary Facilities, although it's a good place to sleep.
11. Press Red and Blue Buttons. Wait for the elevators to arrive. In the Red (Upper) Elevator, Slide Upper Elevator Card Through Slot. Press Up.
12. Push Button for a message. The clue as to type of coolant required for repairs is the color of the flashing light. Go down to the Machine Shop. Put Glass Under Spout. Press (color of the light) Button. Take Beaker to Communications Room and Pour Liquid in Hole. Repeat process for all the subsequent colored flashing lights.
13. In the Blue (Lower) Elevator, Slide Lower Elevator Card Through Slot. Press Down.
14. In Control Room, Push Lever. Pull Lever at 45 MPH. Pull Lever when you see Deceleration Sign. Coax Shuttle into Station, if necessary, by Pushing and Pulling the Lever.
15. Floyd, North. Floyd, Get the Shiny Fromitz Board. Nothing can be done with the broken robots lying around here and in the Infirmary.
16. Open Lid. Remove Second Board. Insert Shiny Board in Panel.
17. Open Cube. Pull Fused Bedistor with Pliers. Put Good Bedistor in Cube. Drop Pliers.
18. Although not necessary for winning, it's fun to Put (Green or Red) Spool in Machine. Turn on Machine. Also, spend some time on interesting reading and background with the computer. Turn on Computer. Type (number).
19. You can change uniforms if you wish. Open Pocket in Lab Uniform. Get Combination and Teleportation Cards. Remove and Drop Old Battery and Install New Battery in Laser.
20. Slide Teleportation Card Through Slot. Push (color) to teleport to other Booths. Combination Lock on Conference Room Door can only be opened from the outside.
21. Read Output. Make sure Floyd sees that the Computer is down, or he won't volunteer to do something later.
22. Open Bio-Lock. Look in Window. Watch Floyd's reaction. Open Door. Close Door. Open Door when Floyd knocks. Close Door. Get Microminiaturization Card.
23. Slide Micromin Card Through Slot. Type 384.

24. With Dial set at 1, Shoot Speck with Laser. Again, until Speck is destroyed. (Try it with a different setting from a saved-game position.)
25. With Dial set at anything except 1, Shoot Microbe with Laser. Again, until Laser is warm and text notes that Microbe has taken interest in the heat. Throw Laser Off Strip.
26. Open Desk. Get and Wear Gas Mask. *Save Game*. Push Red Button. Wait a turn for the gas to take effect. Open Door. West. Open Door. West. (Don't stop to close it!) Open Door. Move directly and immediately to where the Mural was seen. Enter the Elevator. Push Button. (Interesting variations on the game outcome and final printout occur if some of the Comm, Defense, or Course Control units are not repaired and you get through to the final elevator.)

PYRAMID OF DOOM

1. To get into Pyramid, go into Pool back where you started. Get Water (in Canteen). Get Large Key. With Shovel Dig in Desert North of Pyramid. Get Small Key. Dig by Pyramid also. Unlock Tiny Door with Small Key. Move and Drop Stone. Light Flashlight. Unlock Big Door with Large Key. Did you try opening the main door before unlocking the Tiny Door?
2. Search the Ashes. Get Gold Necklace. Wash Coal (need water in Canteen). Get the Ruby, only it's not a treasure! With the Flute from the Hallway, Take Basket. Play Flute. (Pistol won't do it.) Go Passage.
3. Starving Rats will attack randomly. They can be satisfied by the Camel Jerky from the Hieroglyphics Room. Of course, if you did that there won't be any left when you *really* need it. Don't waste the bullets here either—drop them.
4. Feed Oyster (the Beef Jerky). Get Black Pearl and gain access to the Archway, avoiding the Rats. Dump your treasures. Shovel and Flute are no longer needed—drop them.
5. Open and Go Sarcophagus. Pour Water (from Canteen) on Tanna Leaves. Take Tapestry. Get Skull and Box from Alcove. Search Box twice, taking the Iron Glove, but leaving the Box and Bones.
6. In Mummy Room, Search Skull, get Gold Teeth. Drop Skull in the Tall Room. Get Saw.
7. Wear Glove. Hit Wall. Feel Floor in the Mirror Room for Gold Coin. East. Light Flashlight. Get Scarab. West. West. Light Flashlight. Probably a good time to haul treasures up in the Hieroglyphics Room.
8. Saw Table with Saw. Get Diamond Necklace. Shoot the Nomad when he appears randomly.
9. Throw Rope (from Long Narrow Passage). Search Explorer. Get Gold Pin. Search Rubbish for Carving, but only once. As far as the Purple Worm is concerned, he's invincible—you aren't!
10. You can pull the Pharaoh's chain, but to fix him, go back to the Narrow Ledge (over a Pool of Acid). Throw Ruby (his Heart). *Now* pull the Chain. Don't forget the Platinum Crown in the Chest.
11. In the Treasure Room, you need the Iron Glove and Small Key. Wear one and use the other to unlock the Treasure Coffin for the Bracelet. Saw Window to get Platinum Bar. Haul all loot to the Hieroglyphics Room and say Score.
12. A summary of things *not* to do include: breaking mirrors; jumping in (Acid) pool; searching basket twice; pulling chain a third time; searching trash a second time; ignoring the Mummy, Rats, Pharaoh, Worm, and Nomad; opening Pyramid Door before opening Small Door; opening Coffin without wearing Iron Glove. The treasure summary:

Tapestry	Gold Necklace	Diamond Necklace
Black Pearl	Gold Teeth	Gold Pin
Jade Carving	Sapphire	Gold Scarab
Platinum Crown	Emerald Bracelet	Platinum Bar
Gold Coin		

QUEEN OF PHOBOS

Note: Inventory management can be a problem in this game as you can only carry five objects at a time. Objects randomly located at the start of each game include the Token, Wrench, Beer, Pot, Cable, Gas Mask, Gas Grenade, and Electric Crossbow. Be sure to dig in all five planet surface locations. Each of these objects is used once. If you cannot locate the above objects before venturing into the stateroom maze, you'll have a tougher time solving that specific game, so you may wish to consider rebooting.

1. Push Button. Get Message.
2. Get rid of the nuclear device. Don't Push Button. Take it and the cable to the Unidentified Room, Attach Cable, go outside on Hull, and Throw Device.
3. Turn Spigot (need Wrench). Fill Pot.
4. Get rid of the five looters; if you delay too long, they will get you. The objects to use for them are:

Dr. Hunter	Electric Crossbow
Yuggeth	Wear Gasmask; Throw Grenade
Joe	Surgical Chainsaw
Geuse	Zazu Beer

5. At the Claw Machine, Insert token, Hit machine, repeat until you Get Key.
6. Push Button. Teleport to Planet. Dig (need Shovel) in all five locations. If you get zapped back to the ship, Push Button again. Just don't push your luck with a third push.
7. Unlock Locker (need Key). Get Salt.
8. Take the following objects along to get the Mask:

Salt
Pot filled with Electrolyte
Any other object

To get to the center of the ship from the Captain's Quarters, North, North. Then W.S.E.S.E.S.E.
E.E.S.W.S.W.W.N.W.W.W.N.E.N.W.W.S.S.

9. At the Laser Room, throw any object into it.
10. Throw Salt at the Zombie.
11. Throw the Pot with the Electrolyte to get Mask. Wear the Mask or your head will explode.
12. Push Button. If you have the Mask, you are promoted to Field Major. If you don't have the Mask, well—it's a quick way to go.

THE QUEST

1. Buy the lot. You can afford it and there is no inventory problem.
2. Tie Rope. Get Gold. Up.
3. Look Waterfall (opens a passage). Light Lantern.
4. Tie Rope. Down. Get Young Dragon.
5. If the Highwaymen get you, start over. Lisa will teleport you safely away if she is with you, however.
6. Be sure to Buy Salt. Dropping it when the Young Dragon is around will cause him to fly off for parts unknown. Holding it in the presence of the big Dragon will keep you from being incinerated.
7. Knock. Lisa will join you, but takes the Ring. She's handy with Highwaymen and for translating Dragonese.
8. You're right, this Water is poisoned.
9. No, the Village cannot be saved.
10. Give Gold to the Old Man for a clue to a red herring.
11. South. South. Get Key. No matter where you go now, you've had it—this puzzle is the red herring and you're shark bait!
12. Young Dragons die when exposed to water. Put Young Dragon in Oilskin. (Wrap, Cover, Use, Protect or other synonyms won't work.) Move East, and immediately Take Young Dragon out of Oilskin, or he will suffocate, and big Dragons don't take kindly to having dead Cubs delivered to them.
13. Attack. Move out of the area, return and Attack again. Repeat a third time. Get Sword, but its value in the game is questionable.
14. The answer to the riddle is "Sphinx."
15. On entry to Dragon's Lair, Lisa will translate the Dragonese. Talk to Dragon. You must be carrying the Salt to stay alive for this sequence. Go find the Young Dragon Cub, and deliver him *alive* to the big Dragon.

THE SANDS OF EGYPT

1. Get Shovel. North. Kill Snake. With Shovel.
2. Take Canteen. North. If you're going for the fewest moves, Fill Canteen. Take Canteen. Otherwise, take a second trip back after you've gotten some water.
3. Dig. Get Torch.
4. Dig. Get Magnifier.
5. Drop All. Go Tree. Climb Tree. Get Dates. Down. East. East. Take Canteen. Feed Camel (need Dates). Mount Camel. Ride Camel. Dismount.
6. Climb Pyramid. Get Axe. Look Carving. Oil Scepter (need Snake Oil). Pull Scepter. Take Canteen. Empty Canteen. Do the Camel bit.
7. Fill Canteen. Take Canteen. Drink. Drop All. Take Axe. Climb Tree again. Cut and Take Fronds. Braid Fronds. (Get Rope.)
8. Enter Pool. Hook Scepter. On Handle. Pull Scepter. Unhook and Take Scepter. (To get out of Pool, Climb Steps.)
9. Light Torch. With Magnifier. Drink. Drop Canteen. Enter Drain.
10. Float Boat. Enter Boat. Paddle Boat (need Shovel) twice.
11. Tie Rope. To Boat. Tie Rope. To Pole. Go Arch.
12. Translate Hieroglyphics. Drop Scepter. On Mummy. Drop All. Take Torch. Go Crack.
13. Take Ladder. Go Crack.
14. Look to let Boat drift under the Hole in the Ceiling. Drop Ladder. Climb Ladder. Take Canteen. Drink. Climb Steps. Do the Camel bit again, and dismount to fame and riches.

SAVAGE ISLAND, PART I

1. Dig Sand. With Hands. Look Sand. Look Hole. Get Bottle. Drop Watch—it's not too useful. Get Coconuts in Palms and leave at Tidepool.
2. By the Cave, keep away from Bear if he makes you nervous. Empty Bottle in Sink. Leave Empty Bottle by Lake. (You can wash off your nervous perspiration in the Lake, but any carried objects will get dropped.)
3. Return to starting point by Swimming West. Go Crevice. Jump. East. Wait for Hurricane. After Crash, get Palm Log.
4. Take Palm Log to Lake. In Lake, Hold Breath. Drop Log. Swim Down. Swim North. Get Knife. At ARGH, Swim Up. Hold Breath. Swim Down again. Swim East. Get Block.
5. Swim West, leaving all but Palm Log at Secluded Cove. Take Log back East by Lake.
6. Take Knife, Block, and Bottle to Tidepool. Get (Salt) Water. Drop other stuff.
7. Take Bottle to Bear Cave. Go Crevice. Empty Bottle. Wait for Puddle to become Salt Pile. Give Salt to Bear. Fill Bottle (with Rum). (If Hurricane is simply too much for you, Say Yoho, but you can survive the storm the hard way.)
8. When it gets dark, Sleep only at Secluded Cove.
9. Get Bottle across Lake with help of Log. Drop Bottle. Take Log to Lake side by Bear Cave. Up. (Log gets out, you don't!)
10. Cut/Take Vines. Get first Log at Large Plain. Get second Log and Coconut. Don't cut Coconut with Knife; it will work, but leave you in a no-win situation.
11. Build Raft at Tidepool, using two Logs and Vines. Always cut and take a second set of vines for raft rebuilding.
12. Go Raft. Sail Raft to Atoll, Give Bottle to Pirate. Get Bandana and Note. These objects and information are needed for *Savage Island, Part II*.
13. Sail Raft to Beach, Move Stalactite. With Coconut. Go Crevice. Take Block into Force Field. Return to Bear Cave.
14. At the Bat Guano, Dig. With Hands. Get Wire. Exit via maze into cave. Must have Bandana, Block and Wire.
15. At Alien Machinery, Fix Machinery. With Wire.
16. With Machinery fixed, Push Neanderthal's Button. Go to Control Room. When there, Push Button. Say Free. Go Field. Get 123 password.

SAVAGE ISLAND, PART II

1. Say 123 (from Part I. Saying 474 will also start game, but without the Bandana necessary to the solution.)
2. Hyperventilate. Go Field. Breathe Out. Head for the Display Case.
3. Look Hydroponics. Look Plant. Hold Breath. Push Button. Crush Flower. Drag Neanderthal to the Red Metal Room.
4. At Console, Wear Bandana. Push Button. Say Free (from Part I). Push Button.
5. At Blinking Light, Close Eyes. Go Field.
6. On Bridge, Unravel Bandana. Tie Bandana. To Itself. Drop Loop. Go Loop. Push Button (resets Force Field). Don't forget the device.
7. By Medicine Ball (useless), Untie Bandana. Tie Bandana. To Lever. To Treadmill. Go Treadmill. Hold Rail. Run (resets air supply).
8. In Middle Control Room, Push Button. Move Red (Alien Device). Take Block. Go Field (arms Block). Drop it and get out. Drop Loop.
9. Go Loop. Move Blue. Push Button. Get code sequence to decipher the story that came with the game.

SECRET AGENT: MISSION ONE

1. Get Pistol. Shoot Door. Go Cockpit. Open Cabinet. Get Parachute. Go Door.
2. Lift Latch. Jump. Pull Ripcord.
3. Get Fork. Sleep. Hit Nurse.
4. Open Door. Go Door. Open Register (Get Money). Up. Take Card. Drop Card. Go Closet. Close Door. Wait. Open and Go Door. Get Card.
5. Buy Drink. Give Drink. Repeat for information until he simply says "Thanks Man."
6. Return to Hospital. Go Phone. Insert Dollar. 247-6658.
7. Wait until Shopkeeper goes to answer phone. Break Glass. Get Tie. Don't walk by the front of this shop again!
8. Buy Duck. (Get Ring.) Duck. Go Door (Get Doggy Bag).
9. Go to Bus Stop. Wait and Look Watch until half-hour bus arrives.
10. Get Hairpin. Try to catch immediate Bus to town.
11. Break Window. Get Recorder. Move Picture. Open Safe (with Hairpin). Get Tape.
12. Go Elevator. Jose Caldera. Go Elevator. Open Door.
13. Get Package. Go Balcony. Throw Package. Go Room. Answer Phone (Get Password). Look at Recorder and follow instructions. Take Recorder along.
14. Go Gate. Passwords vary, often being Shark or Tiger.
15. Open Crate. Get Statue. Go Crate.

16. Get Rope. Open Door. Drop Food. Go Door. *Close the door!*
17. Tie Rope. Climb Rope. Push Brick (four times). Go Hole. Get Brick. Save Game.
18. The ten by ten Maze is mappable. In the following, A = Straight; L = Left; and R = Right: A R L A R L R L L A R L R L R A R R L R L R L A L L R A R R L R L L R A. Up.
19. Open Door. Hit Guard. Take Uniform (Get Gum).
20. Insert Card. Must have Uniform.
21. Chew Gum. Push Button. Go Elevator. Stick Gum.
22. With Plank from Corridor, Drop Plank.
23. Push following buttons: 1 2 3 3. Don't push 4 or 5.
24. Insert Card and Go Door (after pressing Button 1).
25. In the three or so moves before you get caught, Go Treadmill (causes you to lose two pounds). You should weigh 163 pounds now.
26. Push Gem (On Ring; get Key). Unlock, Open and Go Door. Only to get caught again!
27. Go Water. Unlock Grate. Go Platform. Repeat for Open and Go Grate, using only one move underwater.
28. Insert Card and Go Door (after pressing Button 2).
29. Read Book. Go Table. Go Duct. Get Extinguisher. Insert Card (door won't open if Button 4 has been pressed).
30. Pull Handle. Get Film. Insert Card (door won't open if Button 5 has been pressed). Down. Go Door.
31. Put Film. Look Microscope (Get coded color word, decode with code key from tape). Take Mirror.
32. Look Books. Up (need Mirror).
33. You must weigh what the drunk said, either 190 or 183. For 190, carry the Mirror (27 pounds) and the Recorder (5 pounds), but drop the Extinguisher (20 pounds). For 183 pounds, carry the Recorder and the Extinguisher, but drop the Mirror. The other items don't change your weight. In either case you must have exercised to sweat off a couple of pounds. If you are a non-believer or want to check it out, go back to the Scale. If you can't get back into Gymnasium, go up and push Button 1 twice.
34. Look Computer. Insert Card. Go for Option 2. Enter decoded color, often Violet. Turn Dial (thirty minutes is only fifteen moves).
35. Pull Lever. Whassamatta, didn't work? Short on time? Don't panic, just make sure that Microscope replaced Mirror, where it was found.
36. Go Helicopter—*Now* panic!! (At least for the moment.)

SERPENT'S STAR

1. Buy Horse. Buy Saddlebag. Put Saddlebag on Horse. Buy Tent and put in Saddlebag. Buy Tea, Tsampa and Butter.
2. Tie Horse. Enter. Sit With Westerner. Buy and give him two drinks. Get Lantern and Fuel. (Try a game without buying anything from the Merchant. Ply each man with many drinks and get minor clues. You have insufficient funds to do this in a game you play to win.)
3. Shoot Wolf. Keep Shooting, it may take three shots.
4. Knock on Door. Give Butter.
5. Offer Tea. Don't take the Scrolls in the Library.
6. Ask About Scrolls.
7. Give Tsampa to Monk. Ask About Scrolls. Get Monk's Scroll.
8. No puzzle here if you have the Lamp from the Westerner at the Inn. Fill Lamp. Light Match. Light Lamp.
9. Leave the Crystalline Statue alone—you'll just have to give it up again.
10. Good luck on the jump which comes up next. Save Game.
11. No puzzle here if you left the Statue alone.
12. No puzzle here either, if you have the tent.
13. Put out Flame (three times). Open Door.
14. Get all three gems. Open Box. Get Shell.
15. Lift Lid. Pound around in the darkness for a while.
16. Search Wall. Forward will now work. Get Robes (Wear Robes). Get Staff. Get Key.
17. Unlock Door (with Key). Get Scroll. Examine Staff.
18. T S K D G will shatter the animated statues. Search Rubble. Get Black Stone.
19. Don't mess with them. Forward.
20. Dragon. Yin and Yang. Man. (Yeah, yeah, but they work!) Right.
21. Ring Gong (once) to raise Serpent's Star above pool level. Anything offered at altar just zaps away. Don't forget the Blue Gem. Tsampa may be left.
22. Put (each color) Gem in Door. Sequence is Black, Violet, Blue, Green, Orange and Clear.
23. Save Game. Blow Shell. (Dragon rises up.) Rainbow. Nirvana.
24. Put Serpent's Star in Niche.

SHERWOOD FOREST

1. At Shallow Pool, Get Whetstone.
2. Rob Rich Taxman. Get Bag of Gold.
3. Give Bag to Blind Beggar. Get Flint.
4. At Maid Marion, Get Awning.
5. At Blacksmith's, Fix Grindstone (with Whetstone). Get Steel.
6. At Haystack, Burn Hay (with Steel and Flint). Search ashes twice. Get Needle, Thread and Penny. Flint and Steel are no longer needed.
7. In Tailor's Shop, Drop Needle, Thread, and Awning. Leave and return. Get and Wear Uniform. Take extra Thread.
8. Little John will recognize your uniform and leave.
9. Outside the Cave, Drop All. Now try to Push Boulder again. Get All.
10. At Edge of Cliff, Jump, but only if you have moved the Boulder.
11. Inside the Cave, get the Crank, Life Jacket and Dull Axe.
12. Sharpen the Axe at the Blacksmith's Shop. Drop the Penny and Thread.
13. At Battlefield, Insert Crank in Socket. ("Put" and related synonyms won't work.) Turn Crank. Push Button.
14. Chop Tree. Get Pole. Go Hole. Wear Life Jacket and Uniform.
15. Pry Boulder (with Pole). Get blown into Ocean. All objects except those being worn are lost. Swim around about four turns.
16. On Trading Ship, Trade Jacket. Get Lute without strings. After being dropped off on Pier, retrieve the Penny and Thread in the Blacksmith's. String Lute.
17. On Stage, Dance first. Play Lute. Get Charm.
18. At Maid Marion, Wear Uniform and Charm. You also need the Lute, and a clean face, if you haven't already washed at the Shallow Pool. Kiss her now and she'll follow you anywhere!
19. Get Married in the Chapel. Be sure to have Penny. Get Telescope.
20. At the Battlefield, Mount Telescope. Look through it and Turn Crank until you are lined up on the Castle Window. Push the Button and live happily ever after.
21. Things *not* to do include: Jumping off Pier, into Stream at Bridge, or from the Rocky Ledge (if the Boulder's not in place); attacking Little John or the Sheriff; pushing the Catapult Button before the Crank is installed; going into the Cave from the Boulder side. (Try an obscenity.)

SOFTPORN ADVENTURE

1. Hail Taxi. Casino. To avoid later frustration, run your \$1,000 up to around \$5,500. Look Ashtray. Get the Passcard before leaving Hotel. Save Game. (Note: The 21 game plays from a given deck each game; you can track wins and losses one time and clean up the second time.)
2. Buy what the Pharmacy is selling. Buy first, don't shoplift. Drop Card at Disco Entrance.
3. Buy Whiskey. Give Whiskey (to Businessman). Get Controller. Get Flowers. Open Desk. Look Desk. Read and Drop Paper.
4. Look Basin. Get Ring. Read the Graffiti, but don't flush the toilet unless you wish to test your saved game.
5. Push Button. Bellybutton. Pay Dude.
6. Wear your purchase from the Pharmacy. Seduce the Lady of the Evening. Take Candy.
7. Look Garbage. Look Core. Get Seeds.
8. Show Passcard. Give Flowers. Give Candy. Buy Wine. Dance. Save Game. Give Ring. Take Wine. Give Wine (to Bum). Get Knife. Don't carry Wine in Taxi.
9. You need \$3,000 here. Marry Girl. Follow her to Honeymoon Suite. Take Radio. Listen Radio. Drop Radio.
10. Dial 555-0987. Order Wine. Be sure that you've called the other two numbers.
11. Cut Ropes (with Knife). Get Ropes. Drop Knife.
12. Look Plant. Enter Bushes. Get Stool. Get Hammer. Drop Seeds. Eat Mushroom.
13. Push Button. Bellybutton. TV On. Change Channel to Channel 6. Leave Controller. Up.
14. Use Rope. West. Break Window (with Hammer). Drop Hammer. Get Pills.
15. Give Pills. Nasty break! Push Button.
16. Drop Stool. Climb Stool. Look Cabinet. Get Pitcher. Water On. Fill Pitcher. The Doll in the Closet is a red herring.
17. Water Seeds. Water Seeds. Look Tree. Get Apple. Eat Mushroom.
18. Give Apple (to Eve). Use your imagination to get final message.

SORCERER

1. Frotz Me (or the Spell Book). Get up.
2. Take All. Open Mailbox. Before the Mailman comes, Put Matchbook in Mailbox. When you get thirsty and hungry, Open Vial. Drink Potion.
3. Look Behind Hanging. Get Key. Open Desk. Get Box. Open and Read Journal. You may leave the Journal and Infotater.
4. Take Gaspar Scroll.

5. Look in Mailbox. Get Orange Vial. Get and Read Magazine.
6. Take Meef Scroll. Read about the names and places mentioned in the Calendar and Journal.
7. Press (the five colors corresponding to the "Current Code" as taken from the Infotater in the package). Take Aimfiz Scroll. This is a good save game point. Aimfiz Belboz.
8. You can't deal with either the Hellhound or the Boa Constrictor.
9. To avoid inventory management problems, it's wise to Drop All But Book, Amulet and Orange Vial.
10. Izyuk Me. West.
11. Take Zorkmid. Fear not, one is enough. Don't forget to Izyuk back across the Chasm.
12. Take Fweep Spell. Take Guano and Amber Vial, useless as it is. Don't forget to try the Indigo Potion from the Torture Chamber, which also has no real use in the game. Get here by Pulver-ing the River.
13. Wake Gnome. Give Zorkmid. When he promptly falls asleep, Look in Pockets. Leave the Waxer in the Store.
14. Learn three Fweep spells. Fweep Me. As a bat, move N.E.S.S.W.D.E.E.N.N.U.U.S.E.
15. Take Swanzo Scroll. Put Scroll in Hole. Fweep Me. Don't dally about. Move W.W.S.E.D.D.W.W.U.U.N.N.D.W. Fweep Me. S.E.N.D.W.S.E.
16. Take All. Izyuk Me. Up. West.
17. Get Swanzo Spell from Fireplace.
18. Lower Flag. Search Flag. Get Aqua Vial.
19. Put Guano in Barrel. Get Yonk Spell.
20. Give the poor guy the Zorkmid.
21. Take the Ball. Open Aqua Vial and Drink Potion. Throw Ball at Bunnies. Get Malyon Spell.
22. Learn Malyon. Yonk Malyon. Malyon the Dragon. A good place to save the game.
23. Open Orange Vial. Drink Potion. Write down the combination your "self" gives you. Give Spell Book.
24. Turn Dial to (the combination). Open Door. East. Get Rope.
25. Tie Rope to Timber.
26. Drop All but Rope. Throw Rope Down Chute.
27. Take Golmac Spell. Golmac Me. Open Lantern. Take Vardik Scroll.
28. Self, combination is (whatever it was). Get Spell Book (back) from Self.
29. Meef the Spenseweeds. Get Crate. (Try reading your Spell Book if you didn't drop it before your swim.) Sleep before proceeding, or you may forget some spells.
30. Meef the Vines. Wearing the Grue Suit and/or with your Lantern On, and having learned a Vardik and Swanzo Spell, charge on to the West for the final confrontation.
31. Open White Door. Vardik Me. Swanzo Belboz. Victory, 400 points and a promotion are thine!

The Spells of The Sorcerer

Spell	Description	Location
GNUSTO	Write a Magic Spell into the Spell Book	Spell Book
VEZZA	View the future	Spell Book
PULVER	Cause liquids to dry	Spell Book
IZYUK	Fly like a bird	Spell Book
YOMIN	Mind Probe	Spell Book
REZROV	Open Even Locked or Enchanted Objects	Spell Book
FROTZ	Cause Something to Give off Light	Spell Book
MEEF	Cause Plants to Wilt	Library
GASPAR	Provide for your own Resurrection	Helistar's Room
AIMFIZ	Transport to Someone Else's Location	Trunk
FWEEP	Turn Caster into a Bat	Hidden Cave
SWANZO	Exorcise an Inhabiting Presence	Chimney
YONK	Augment the Power of Certain Spells	Cannon
MALYON	Bring to Life Inanimate Objects	Arcade
GOLMAC	Travel Temporally	Slant Room
VARDIK	Shield Mind from an Evil Spirit	Slant Room

Potions of the Sorcerer

Color	Name	Description	Location
Ochre Vial	Berzio	Obviate Need for Food and Drink	Store Room
Orange Vial	Vilstu	Obviate Need for Breathing	Mail Box
Indigo Vial	Flaxo	Exquisite Torture	Torture Chamber
Amber Vial	Blort	Ability to See in Dark Places	Hidden Cave
Aqua Vial	Fooble	Increase Muscular Coordination	Flag

STARCROSS

1. The syntax to set Range, Theta, and Phi is "Computer, Range is xxx." Read Range from the line extending from the center to the right of the map; Theta is read clockwise in 15 degree steps from the top of the map; Phi is the number in brackets below the object number. Computer, Confirm. Later, Enter Airlock.
2. Press Fourth Bump, Push Tiny Column. Take Black Rod. (Counting the Sun, the Earth would be the fourth bump out.)
3. Throw Library at Nest. Get Red Rod. Get Library.
4. Give Tape Library to Spider. Get Yellow Rod.
5. Insert Yellow Rod in the Yellow Slot to light the initially dark areas. Insert Red Rod in Second Red Slot to start manufacture of oxygen (an oxygen atom has eight electrons. The other slots represent CH4 and NH3, respectively). Try playing around with the other slots; you'll eventually die, but it's cleverly done.

6. The Basket will hold all the Rods you can ever find. Tie Line to both Hook and Spacesuit. Get Pink Rod.
7. The Disks are teleportation devices. Drop one somewhere, go somewhere else and drop the other to arm it—then stand on it. To get the Blue Rod, start with one Disk somewhere else and put the other under the Sphere; with the Dial on 2, put the Basket on top (with at *least* three Rods in it) and turn the Dial to 4. Everything will zap to the other Disk.
8. Look in the Gun Barrel. Get Silver Rod. The Gun's three shots can get you all kinds of interesting responses, but it really has only one use.
9. Let the Mouse take everything except one Disk. Wait a while, or follow him until he disappears in the wall. Drop the other Disk and stand on it. Collect all your objects again and search the garbage until you find the Green Rod.
10. With the Square, Open Panel, Insert Square, Close Panel, Turn Switch on. Get Gold Rod.
11. Drop a Disk somewhere before meeting the Chief. Wait for him in the Village Center, and point back at his Brown Rod. Swap him your Spacesuit for it. Don't take no for an answer. Follow Chief into the Warren to its Center.
12. Move Skeleton. Get Violet Rod, be sure to take the Visor before standing on the Disk to get out. Make sure you have done all you need to with the Disks before this. (Save the game first, but did you ever take the Skeleton?)
13. Look at Projector with Visor. Get Clear Rod.
14. Put White Rod in White Slot, but putting the Black Rod in the Black Slot will shut down the ship, and is dangerous to your health.
15. Shoot the Gun at the Drive Bubble three times.
16. Put the matching colored Rods in the Slots; if you don't have them all, you're in deep trouble! Touch Large Pink Square until the Solar System is seen out to Jupiter. Touch Brown Spot until Earth is highlighted. Touch Violet until line terminates in a circle around Earth. Touch Green Spot until the dots flash slowly. Touch Blue Spot. If you didn't get 400 points, check the scoring below.

Scoring Summary

(25 points for each of the following tasks or items)

Reaching Artifact's Airlock
 Black Rod (Entering Artifact — press 4th)
 Yellow Rod (Give Spider the Tape)
 Red Rod (Break Rat-Ant nest with Disk or Tape)
 Pink Rod (Lizard Man — Yellow Dock — need Suit)
 Brown Rod (Give Spacesuit for Rod — to Chief)
 Violet Rod (Move Skeleton)
 Silver Rod (Look in Ray Gun barrel)
 Clear Rod (Look at Laser with Visor)
 Green Rod (Turn on Computer — need the Square)
 Blue Rod (Disk under, Basket on Sphere, Dial 14, teleport)
 White Rod (Lying loose in the Drive Bubble)
 Entering Control Bubble (Fire Gun at Drive Bubble)
 Proper Control sequence (Pink, Brown, Violet, Green, Blue)
 Reaching Earth (Proper orbit — “Galactic Overlord”)

STRANGE ODYSSEY

1. Get Suit, Shovel and Phasor. Look Console. Push Red. Wear Suit. Go Door. Push Red. Jump.
2. In Cave. Set Phaser. On Destroy. Shoot Boulder. Go Curtain.
3. Pull Rod. Push Rod. Touch Plastic. Plastic will glow one to seven times. Go Curtain.
4. One Glow: Back to initial Cave entry point.
5. Two Glows: Dig in Grassy Plain with Shovel. Get Pick. Set Phaser. To Stun. Shoot Hound. Take Hound. Return to Hexagonal Room. (Air is breathable here. Remove Suit here and in Hexagonal Room to conserve air supply. Read Gauge on Suit.)
6. Three Glows: Drop Hound. Find Mound. Set Phaser. To Destroy. Pick Mound. Shoot Hound. Take Diamond. Shoot Mound. Return. (Save Game on entry as Hound is unpredictable and there are areas from which no return is possible.)
7. Four Glows: Refill air supply here. Connect Hose. Push White. Push Black. Read Gauge. If under 90, Push Black again. Note that another time can pop the suit.
8. Five Glows: Nothing except an easy way to get killed!
9. Six Glows: Get Sculpture. Take Belt from Sculpture. Look at Painting while wearing Goggles after Pushing Yellow.
10. Seven Glows: Wear Belt. Twist Buckle. Go Light. Get Brandy. Return. Repeat, getting the Piece of Metal.
11. Reset to Scoutship location. Pull Rod. Touch Plastic. Push Rod. Touch Plastic. Then Pull Rod. Break and Take Rod. Return to spaceship. Will take two trips.
12. Go to Storage Hold. Open Access Hatch (with Piece of Metal). Drop Rod. Push Blue. Exit ship. Drop all five treasures. Type score.

SUSPENDED

1. To minimize casualties, send a robot to Weather Control, turn second dial to zero.
2. Repair Iris, have Waldo wear the extension from Middle Supply, open the maintenance panel, replace the rough device with the rough object in the basket, and close the panel.
3. Repair the machine in Main Supply by taking out the bubbly and the disfigured devices. Put the red object (from the basket) in the red socket, and the yellow object in the yellow socket.
4. Get the first replacement cable in Main Supply by pushing button on machine, taking the fuse, then taking the cable. Be sure to put the fuse in the machine again, and to write down the possible computer reset codes.
5. Get beyond the Hallway Junction by getting the ramp from Sub Supply and putting it on the step. Carefully check out the Sub Supply for other objects, even though you don't need them.
6. After getting to the sloping corridor, take the ramp and go to the Small Supply. Drop and stand on the ramp to get the Cutting Tool. Pick up the ramp again, and go to the Hallway End. Get in, then get out and get the TV Camera in the Biology Laboratory. The vehicle from the Hallway End won't run for all robots, and some can't get into it.
7. The "Talking Mechanisms" can be slowed down considerably by having Auda follow them to the Sleeping Chamber, taking the Bag and going to Maintenance Access. The humans will follow and fix the acid leak that kills off your robots.
8. Get the second replacement cable in Gamma Repair. Have Sensa look at the large object and then turn the flowswitch. She needs the help of another robot, so "Both Sensa and xxx, Move Fred," the name ascribed him by Poet.
9. In either Channel, plug the TV camera in and point it at different objects to get the lay of the cables and the reset codes for the FC. Its a good idea to save the game before playing around with the cables, for several reasons.
10. In the Primary Channel, replace the red four-inch cable with the red twelve-inch cable from Fred.
11. In the Secondary Channel, replace the orange nine-inch cable with the orange fourteen-inch cable from the Machine in Main Supply. Poet can't tell which is the bad one, so the way to find out is to take them out one at a time. The one that doesn't kill your robot is the bad one!

TIME ZONE

Time Machine Operation: Enter Machine. Sit Down. Turn Orange (year). Turn Blue (location). Pull Lever. On first entering, Get Mask and leave it outside. It would disappear if taken back before its time. Pushing Button will return ship Home.

400MILBC Prehistoric: Get Stick. You can hide in cave to avoid the Pterodactyl.

10KBC Stone Age

1. After getting Rock, Climb Tree to avoid Mastodons.
2. After getting two Sticks, Kill Tiger. With Stick.
3. Kill Hare. With Rock.
4. Give Hare. Make Fire (with two Sticks). Get Hammer.

1000AD SA, Inca City

1. Drop Hammer, but be sure to get it on the way back.
2. Open and Go Door. Get Torch. Drop Torch from top of Pyramid.

1700AD EUROPE, Paris

1. Climb Fence (in Back of Stone Fence). Down. Inside.
2. Open Door (East end of Hall). Get Perfume and Comb.

1400AD NA, Prairie

1. Down into the Gully so the stampede can pass overhead.
2. Give Comb. Get Bow and Arrows.

1400AD EUROPE, Palos

1. Open and Go Door. Talk Man. Yes. On Deck. Get Pass. Show Pass to board ship.
2. Climb Ladder. Look Telescope (see Farmhouse). It is possible but undesirable to sail with the ship.
3. You can now open Farmhouse Door. Get Iron Bar.

1700AD AUSTRALIA: Unlock Padlock. With Bar. Open Door. Get Saw.

1700AD NA, Philadelphia

1. Break Window. Enter Window.
2. Break Trunk. With Saw. Get Skeleton Key. Leave the Kite! (You can Tie Key, To Kite and Fly Kite. Guess wha' happens!)

2082AD ASIA, Tokyo

1. Enter Subway. Sit Down. Answer Voice with West. Look. Exit Subway.
2. Unlock Door. With Key. Get and Drop Lock. Open Door. Get Yen. Take Subway to the North Side.
3. Open Door to Restaurant. Order either selection 2 or 3. Eat Food.
4. Open Drawer. Get Matches. Do Dishes. Take Time Machine home just long enough to get the Oxygen Mask.

2082AD NA, Los Angeles

1. Get and Drop Mat. Get Key.
2. Unlock and Open Trunk. Get Dynamite. Travel to Neburon (4082AD IP) and after Lighting Torch (With Match), Drop Iron Bar, Saw, Keys, Matches, Mask and Dynamite. Go Home just long enough to Drop Mask.

50BC AFRICA, Thebes

1. Carrying Lit Torch, Rock Hammer, Perfume and Bow, Give Perfume (to Cleopatra). Get Money.
2. Buy Dates. With Money. Yes.
3. Eat Dates. Drink Water. (Don't go into it, however.)
4. Open Door. Enter Door.
5. Move Stone. Get Shield.

50BC ASIA, China

1. Get Pole. Enter Boat. Cross Yangtze. Exit Boat.
2. Leave the Emerald alone.
3. Get Shovel. Dig twice. Get two pieces of Jade.
4. Buy Rice and Rope. With Jade.

50BC AUSTRALIA: Dig Ground (need Shovel). Get Rhea Egg. Don't Drop it until you're through using it.

1000AD EUROPE, Nottingham

1. Talk Robin. Yes. Go South, South, East. Kill Dryad. With Bow. Go West, West and get your second assignment.
2. Open and Go Door. Get Mirror.
3. Tie Rope. To Arrow. Look Window. Shoot Arrow. Pull Rope. Get Bag of Money. Go back to Time Machine for a side trip.

1000AD AUSTRALIA: Trade Mirror. Get Boomerang. Return to Nottingham.

1000AD EUROPE, Nottingham (second visit): Give Money to Robin Hood and Kill Knight. With Boomerang.

1400AD ASIA, Japan

1. Kill Samurai. Throw Boomerang. Get Sword.
2. Trade Rice. Get Silk.

50BC EUROPE, Rome

1. After Getting Tweezers, get tossed into the Lion's Den. Look Paw. Pull Thorn. With Tweezers. Open Cage.
2. Loop around Upper Level. Get tossed into Arena (need Sword and Shield). On leaving, get invitation (to visit Caesar).
3. Get Ladder. You can even be a witness to Brutus' doing his thing.

2082AD AUSTRALIA, Sydney: Break Window of the House. Enter Window. Go directly to Bedroom Closet and Get Coat. Return directly to Time Machine before the Police arrive.

1700AD ASIA, St. Petersburg

1. Wear Coat.
2. (Save game.) Kill Kossack (need Sword).

3. Stand in front of Castle Door. Look Guard. Talk Guard. Look Door (three times) or until Coach appears. Get Hat Pin. If nothing has happened after about ten commands, restart at Kossack and approach from a different direction.
4. Make Hole. In Egg. With Pin. Empty Egg. Get Water.

1000AD AFRICA, Congo

1. Drop all Logs (three) where you first found the middle Log. Make Raft (with Rope). Cross Congo River from this location only, using the Pole.
2. While you can avoid the Lion, you can also Kill Lion. With Bow.
3. Get Tusks. With Hammer. Use Ladder. Be sure to Get Rope after crossing River.

1400AD AFRICA, Morocco

1. While moving in Desert, a message will warn you to Drink Water.
2. At Bazaar, Trade Tusks. Get Knife. Move North, West, South to loop back to the Bazaar again. Trade Silk. Get Rug.

1000AD ASIA, Baghdad

1. Trade Rug. Get Camel. (Don't move into Desert without Riding Camel.)
2. Off. Open Sesame. Carrying Torch, Get Gold.

2082AD EUROPE, London

1. Read Note. Yes. Get Dog. Tie Rope. To Dog.
2. Untie Dog. Get Gun. It is now time to tackle Neburon.

NEBURON

Before undertaking the final assault, verify that you have the following fifteen items in your inventory and that you are wearing the Mask:

Oxygen Mask	Torch	Knife
Iron Bar	Lance	Gold
Stone Hammer	Hat Pin	Laser Gun
Skeleton Key	Ladder	Dynamite
Matches	Rope	Hacksaw

1. Open Grate. Use Hammer. Open Grate. Enter Grate.
2. Open Manhole. Use Knife. Open Manhole. Get Wallet. Open Wallet. Get ID Card.
3. Tie Rope. To Rock.
4. Open Grate. Mask may now be removed. Open next Grate.
5. Move South. East. Close Door. (Hide in Closet.) Look Peephole until Guard leaves.
6. Shoot Guard. With Gun. Get Uniform. Wear Uniform.
7. Saw Bars (with Saw). Leave Jail.
8. Shoot Thief. End up in Hospital. Show ID to Doctor and Receptionist to get out. Alternatively, Give Gold.
9. Open Door. Buy Flashlight. Show ID. Get Flower, but don't smell it.
10. Move Block. With Bar. Wear Mask. Flashlight On.

11. Open Grate. Use Ladder. Open Grate.
12. Open Cabinet. Look Drawer. Get Diagram. Learn your true mission.
13. Open Drawer. Get MC Card.
14. Unlock Safe. With Pin. Open Safe. Get password Allegiance.
15. Open Door. East. Close Door. Shoot Ramadu. With Gun. Open Drawer. Look Drawer. Get Ramadu's MC Card.
16. Insert MC Card.
17. Open Door. West. Close Door. (Hide in Shed until Guard comes and leaves—about twelve Looks.) You can go further and get to step 20, but "You Hear Somebody Coming" around then, and it is dicey to hide in time.
18. Unlock Gate. With Key (Skeleton Key, that is). Open Gate. Drop Laser Gun.
19. Talk Guards. Say Allegiance.
20. Show ID Card. Show MC Card.
21. Give Flower (to Guard). Open Door. West. Close Door.
22. Use Lance—it will safely explode Laser Mines. Drop regular MC Card. Verify that you have Ramadu's MC Card.
23. Insert Ramadu MC Card.
24. Drop Dynamite. Light Fuse. No, you aren't done yet! Ya gotta Go Home.
25. Stand X. Push Button. Zapped to Time Machine. Go Home amid music playing, the key to the city, and to accolade of Ultimate Adventurer.

Time Zone Object List
(Usage Sequence)

What	Where	When	Where Object is Used					
1. Pointed Stick	Prehistoric	400MBC	Stone Age	10KBC				
2. Rock	Stone Age	10KBC	Stone Age	10KBC				
3. Hare	Stone Age	10KBC	Stone Age	10KBC				
4. Small Sticks (2)	Stone Age	10KBC	Stone Age	10KBC				
5. Stone Hammer	Stone Age	10KBC	Africa	1000AD	Neburon			
6. Torch	South Amer.	1000AD	Asia	1000AD	Africa	50BC	Europe	50BC Neburon
7. Comb	Europe	1700AD	North Amer.	1400AD				
8. Perfume	Europe	1700AD	Africa	50BC				
9. Bow and Arrows	North Amer.	1400AD	Europe	1000AD	Africa	1000AD		
10. Boarding Pass	Europe	1400AD	Europe	1400AD				
11. Iron Bar	Europe	1400AD	Australia	1700AD	Neburon			
12. Padlock (Broken)	Australia	1700AD	Not Used					
13. Saw	Australia	1700AD	North Amer.	1700AD	Neburon			
14. Kite	North Amer.	1700AD	Not Used					
15. Skeleton Key	North Amer.	1700AD	Asia (N)	2082AD	Neburon			
16. Padlock (Open)	Asia(W)	2082AD	Not Used					
17. One Yen	Asia(W)	2082AD	Asia (N)	2082AD				
18. Matches	Asia(N)	2082AD	Inca Torch		Neburon			
19. Oxygen Mask	Home	1982AD	Neburon only					
20. Key	North Amer.	2082AD	North Amer.	2082AD				
21. Door Mat	North Amer.	2082AD	Not Used					
22. Dynamite	North Amer.	2082AD	Neburon only					

(Continue on with Lit Torch, Rock Hammer, Perfume and Bow)

23. Dates	Africa	50BC	Africa	50BC				
24. Egyptian Money	Africa	50BC	Africa	50BC				
25. Shield	Africa	50BC	Europe	50BC	Europe	1000AD		
26. Pole	Asia	50BC	Asia	50BC	Africa	1000AD		
27. Jade Pieces(2)	Asia	50BC	Asia	50BC				
28. Shovel	Asia	50BC	Asia	50BC	Australia	50BC		
29. Rope	Asia	50BC	Europe	1000AD	Europe	2082AD	Africa	1000AD Neburon
30. Rice	Asia	50BC	Asia	1400AD				
31. Rhea Egg	Australia	50BC	Asia	1000AD				
32. Mirror	Europe	1000AD	Austrlia	1000AD				
33. Boomerang	Australia	1000AD	Asia	1400AD	Europe	1000AD		
34. Bag of Money	Europe	1000AD	Europe	1000AD				
35. Lance	Europe	1000AD	Neburon only					
36. Roll of Silk	Asia	1400AD	Africa	1400AD				
37. Sword	Asia	1400AD	Europe	50BC	Asia	1700AD		
38. Tweezers	Europe	50BC	Europe	50BC				
39. Ladder	Europe	50BC	Africa	1000AD	Neburon			
40. Coat	Australia	2082AD	Asia	1700AD				
41. Hat Pin	Asia	1700AD	Africa	1400AD	for Egg	Neburon		
42. Water	Asia	1700AD	Africa	1400AD	in Egg			
43. Logs (3)	Africa	1000AD	Africa	1000AD				
44. Ivory Tusks	Africa	1000AD	Africa	1400AD				
45. Persian Rug	Africa	1400AD	Asia	1000AD				
46. Knife	Africa	1400AD	Neburon only					
47. Camel	Asia	1000	ADAsia	1000AD				
48. Gold	Asia	1000AD	Neburon only					
49. Police Dog	Europe	2082AD	Europe	2082AD				
50. Laser Pistol	Europe	2082AD	Neburon only					
51. Wallet	Neburon	Side6K	Not Used					

52. ID Card 10082	Neburon	Side6K	Neburon
53. Uniform	Neburon	Side6K	Neburon
54. Flashlight	Neburon	Side6K	Neburon
55. Large Flower	Neburon	Side6K	Neburon
56. MC Card	Neburon	Side6L	Neburon
57. Diagram (Rocket)	Neburon	Side6L	Not Used
58. Note (Allegiance)	Neburon	Side6L	Neburon
59. Ramadu MC Card	Neburon	Side6L	Neburon

TRANSYLVANIA

1. In Victorian House, Get Pistol. Leave Bread.
2. On Wagon, Open Coffin. Get Mice and Silver Bullet. Load Pistol. When Werewolf shows up, Shoot Werewolf; prior to having a loaded gun, move away as soon as he appears. Drop Pistol.
3. In Cabin, Pull Antlers. Get Cloak. There's a pick in the pocket, but don't search cloak yet as you'll have enough inventory management problems. Leave Garlic in Shack across street.
4. In Hut, Drop Mice (for the Cat). Get Broom and Acid.
5. Take Cross from Cemetary to Castle. When Vampire appears, Wave Cross. Drop Cross and leave Broom for now. Get Ring by opening Coffin in Treasure Room. Get Flypaper on way out.
6. At Ancient Stump, Pour Acid. Knock Stump. Catch Flies. Read Book. Pick Lock (Wear Cloak to find). Look Crystal Ball. To get out, Take Book.
7. Give Flies to Frog for magic word IJNID.
8. Say IJNID to Goblin King. Get Key.
9. At Cemetary, Move Grave. Open Grate (with Key). Get Magic Elixir.
10. At Clearing, Search and Wear Cloak. Wear Ring. Wave Hand. Leave, but return after streaking flame is seen in sky. Enter Saucer. Get Black Box.
11. In Tower, with Broom, Black Box and Elixir, Get Vines. Push Button. Wave and Pour Magic Elixir. Clap Hands. Take Sabrina. Ride Broom. Down. Go. Sailboat. Sail Boat.

ULTIMA I

No puzzles as such occur in this game; thus, I cannot offer a specific solution. In fact, I can offer only a few hints because the game essentially requires only patience to beat. I have identified no specific advantage to any particular race or type of warrior, but whichever you choose, balance out your attributes reasonably well. At the outset, relatively high Strength and Agility are of value, but there are no attribute requirements associated with being able to use any particular weapon or armor.

After getting your first display, head Northwest for the castle and town of Lord British, and hit the store, buying a bit more food, which goes in a hurry when you're above ground. In the friendly shops, you will find "new," more advanced items for sale as the game evolves and as your character develops. Even if an advanced item, such as a top-of-the-line Reflect Suit or a Phazor, is not listed as available, it is always there for the stealing. Therein lies the biggest clue: go to the food, armory, and weapons stores and try your luck at stealing. No doubt you will get caught much of the time, but with a bit of luck, like glomming on to Plate Armor or a Light Sword as a minimum, a few lengthy rebooting cycles are a small enough price to pay. Note that in this game, unlike *Ultima II*, your game position is not saved when you enter or leave a town or castles. You must specifically (Q)uit to save the game. Therefore, as soon as you get something good, duck out of the town, do a quick save and then head behind the counter again!

Once you're reasonably well-equipped, the first major expenditure you should save your pennies for is a ship. Buy a couple of up ladders and about 200 to 300 hit points from your buddy the King, and head for the nearest dungeon. Don't go down farther than, say, the second level for a while. The gold comes fairly easily, just make sure you can get out after you've amassed some loot. As soon as you can afford your ship, your real problems are over, and it's monster-whomping time in earnest for the gold you need for hit points, spells, and all that good stuff.

Hit each of the four continents and all eight of the castles. You can see from the maps that all are easily accessible from the water, so an air car, while sporty, isn't really necessary. Take on all eight quests. With lots of up and down ladders, a few offensive spells for the lower levels, and a bunch of hit points, make your real move in one of the dungeons. The Gellatinous Cube, found mostly on levels 3 and 4, can destroy your armor, and you cannot ready new armor underground. Try using down ladders, down to say level 9, where the Balron lives. Get him first while you still have armor, and work your way back up, trying to get the other three monsters needed to fill your quota of quests. After reporting back to the appropriate Kings, you'll have the four gems you need, and will have materially enhanced your attributes.

The space bit, which should come next, is fun and well explained in the documentation. Just keep a record of the directions in which you've gone. Avoid moving diagonally (unless you're really sure of your location). As soon as you've downed ten enemy fighters, you will be told that you are an Ace. Get back to good old Terra Firma as soon as possible.

Assuming that you've got the best in weapons, armor, and about 6,000 hit points, get the Princess out of jail. Try to force the Jester down toward the entrance of the jail area, then kill him for the key. This starts the guards toward you with most unfriendly intentions. You can lead the guards around various obstructions to minimize the number that can get to you at any one time. The hit point damage you incur is proportional to the total of hit points you have at a given time. Hang in there: I once got out with only 6 hit points left to my name. Be of stout heart, because sometimes the Jester has the "wrong" key and it's reboot time.

As soon as the Princess is safe, and using the hit points that she awards you, load up on even more hit points and head for the area she told you about. (The spaceship is often found at the Grave of the Lost Souls.) Once you meet Mondain, the only mandatory trick is to move next to the gem and (G)et it. If you don't, his power continues to regenerate and you'll never get him.

Castle Locations and Quests

Area	Castle Name	Quest	Reward
1	White Dragon	Grave of Lost Souls	Strength
1	Shimano	Balron (Level 9)	White Gem and "Grabs"
2	Barataria	Pillar of Ozymides	Strength
2	Rondorlin	Carrion Creeper (L6)	Green Gem
3	Lord British	Tower of Knowledge	Strength
3	Lost King	Gellatinous Cube (L3)	Red Gem
4	Olympus	Sign Post	Strength
4	Black Dragon	Lieche (Level 5)	Blue Gem

Monument Locations and Rewards

Area	Monument Name	Reward
1	Grave of Lost Souls	Stamina
1	East Sign Post	Nothing
2	Pillar of Ozymides	Wisdom
2	Pillar of Argonauts	Weapon
3	Tower of Knowledge	Intelligence
3	Pillars of Protection	Agility
4	Sign Post	Stamina
4	South Sign Post	Agility

ULTIMA II

Since the puzzles play but a small role in the game, I cannot specify an exact solution. Rather, gold, gold and more gold is needed to win, and the only way to get it is to whomp monsters and then whomp some more. Aside from gold, many critters carry objects which you can use to commandeer and operate ships, aircraft, and spaceships.

There are a total of five time periods in the game:

Time of Legends	Time before time	(Minax)
Pangea	9 Million B.C.	(Good place for gold)
B.C.	1423 B.C.	(Where you start)
A.D.	1990 A.D.	(San Antonio)
Aftermath	2112 A.D.	(Rocket Ships)

It is important to learn how to get to a given time period and to recognize the one in which you find yourself. The easy way of time tripping is to find out how to get to the Time of Legends from each of the other periods, and use the four time portals there. From left to right, these portals go from the earliest (Pangea) to the latest (Aftermath). The tablecloth that comes with the game is handy, once you decipher it. (The Rune-written title on it deciphers to The Time of the Legends.)

The most fruitful place to spend one's gold is Old San Antonio, for the games puzzles are centered here.

1. (O)ffer money to the Hotel Clerk in the California Hotel. You may simply get a "Thank You," but usually a randomly selected attribute is enhanced by four points per hundred dollars tendered. Strength, however, is never augmented, so start out with at least 30 (and preferably 40), because that's all you'll ever get. All others should be in the 90's to optimize your chances for the final assault. Warning: The maximum for any attribute is 99. If you increase an attribute over 99 it starts over at zero again.

2. Visit the old man in the garden at the top center (behind two locked gates). (O)ffer him \$500 (minimum) and he will charge you to “Get the Ring,” which, from (T)ransacting with various parties, you have no doubt deduced is on Planet X at 9,9,9. Well, not quite; after stealing a spaceship from Pirate’s Harbour in the Aftermath, you simply get Father Antos’ blessing in Town Besko, the only town on Planet X. You must then return to San Antonio and the old man. (O)ffer him \$500 (minimum) and “The Ring is Yours.” The Ring permits you to walk through fire, a necessity later on. Watch out that a Thief doesn’t steal it. Save your game and check your inventory before entering any time portal, city, or castle to make sure you still have it.

3. The Quick Sword may be obtained from Santre, the prisoner in the second prison cell on the left. (O)ffer him \$500 (minimum) and he’ll promptly fork it over. Note that you’ll have to fight your way in and out. This is a good place to use (N)egate. Unlock the door to the prison, (A)ttack the Guard—you’ll get a free hit before he reacts. Back up and lead him out the door, press (N), and make a run for the cell. Note that an agility of about 40 is needed for you to use the Quick Sword.

Try life as a Cleric as it makes things a bit easier, especially in the Dungeons and Towers; however, unlike *Ultima I*, you do not have to enter them if you don’t wish to. Exploring them is optional, and it’s quite possible to get through the game, defeating Minax, without ever setting foot in them. At the outset of the game, try to avoid combat and head Northwest, making for the town just Southeast of the Castle you will see. Try to (S)teal a weapon, armor and some food. Make sure you have enough agility and strength to handle what you’ve stolen. Should you be successful, leave the area, which essentially saves the game for you. Now—just maybe—you’ve got a chance to survive.

As soon as you’ve won a Blue Tassle (check “Z” periodically), save the game to protect it from Thieves. Look for a ship, because that’s the most efficient monster whomper around. Move onto it and (B)oard. In some versions, a program bug causes another ship to follow the one you’ve commandeered. You can leave the first and board the second, and repeat this process until you’ve got a whole flotilla. In three full games, I have always found it easiest to get the first ship in the Pangea period, 9 million B.C., also a good place to get rich reasonably quickly.

You may have to fight for your first ship in the A.D. time period. In Port Boniface, (T)ransact with a Guard near the entry blocks to make sure he’ll say “Pay Your Taxes.” (Those who don’t are invincible.) Attack him, moving yourself around under the block so that only one guard can get at you. Keep trying. If you don’t make it, don’t leave town. Restart and try again; you’ll restart as you were before you entered. The corollary is *never* to leave a location unless you’ve improved your lot in life. If you are successful in killing a guard, leave immediately; you now have two keys.

Re-enter the Port, move near the gate to the shipyards in such a way that the guys on the other side are not in front of the gate. Use a (N)egate spell, unlock the door and run for a ship. Once on board, beat up the Guards who come to you as this will build up your inventory of Keys. Assuming that you have a Skull Key and Brass Button, this is an opportunity to head for San Antonio again and get an airplane. You can’t buy them, so unlock the door, kill the attendant, (B)oard a plane and (L)aunch.

The best place to get Gold in a hurry is on the oblong continent of the Time of Legends, where Minax hangs out. You need to be able to take care of yourself in order to survive here, as ships, at least initially, are in short supply. Assuming you can control the fighting enough to take on only one attacker at a time (ie., in the approach to the area you enter), it’s best to have an airplane behind you. As soon as a ship appears, fly to and (B)oard it.

Sail either to the East or West coast. Move to the right, for example, and clobber the critters there while more critters gather on the far shore. Then sail over and repeat the process. In this manner you should be able to collect enough Gold to buy up to over 9,000 hit points and get into the 90’s on all attributes. Only then are you ready to try to do in dear old Minax.

To save yourself \$4,500 of your hard earned gold, here are the Sage’s clues (at \$100 times the number of the clue):

1. The Queen is the King; the King is a Spy.
2. The evil men do is a horrible thing.
3. But dispelling means that you must have the ring.
4. Just where it is I cannot say.
5. But I’ll tell right now there’s no other way.
6. I hear in a town where the water runs free.
7. There is an old man living under a tree.
8. He has not a name, but he has got a clue.
9. Mayhaps if you find him, he’ll tell it to you.

The Bartender's tips for the indicated number of gold pieces are as follows:

1. Hmmmm.
2. Some Fighters Wear Magic Helms.
3. Hmmmm.
4. Saylor's Wear Blue Tassles.
5. Aviators Use Skull Caps.
6. Guards Carry Keys.
7. Mages Carry Wands or Staffs.
8. Planes Need Brass Buttons.
9. Caugh.

As to space travel, watch out for the computer changing your input values of Xeno, Yako and Zabo. As you may have gathered, you can fly to the eight known planets as well as Planet X and, if you're suicidal, the Sun. There is no requirement to do so, but several are rather interesting, even though the Dungeons, Towns, Stores and Prices are all very Earth-like. While only a cave can be found on Mercury and Saturn has naught but some roaming monsters, all the rest have either towns or villages. Uranus's is somewhat different and full of jesters, while Neptune, where you can easily get lost, boasts a Computer Camp.

ULTIMA III

There is no set solution to this game. It's long, even with these gold and time saving clues. Try forming a party and transferring all food and weapons to one member. This is best done within the Castle, avoiding monsters with which you can't cope. Leave the town to save the game, hit Reset, reboot, delete the empty character shells, and create three more. Go to town and buy your front line men with bows; these have the major advantage of hitting targets from a distance. Consider using a Cleric with 25 Wisdom points, as you'll need all the healing power he can muster.

You'll be able to get to a maximum of 550 hit points, initially, by (T)ransacting with the King, provided you have enough experience. With your 550 points, go to the dungeon in the northeast corner of the island, in the blackened area. You'll recognize it by its waterway and protecting ship. In the first two levels, you should find two "plates," which you should touch. One yields the Mark of the King; and the other the Mark of Fire, which permits you to walk through fire. With the Mark of the King, you can now get up to 2,550 hit points, again provided that you have enough experience.

When you leave the Castle, go west 8 steps and south 34. When the moons are in 0,0 conjunction, the town of Dawn will appear below you. In it you'll be able to buy better armor and weapons, as well as the keys, powders which negate time, and gems which permit a screen display of the local area. More important, in the lower right corner are three guys, each with important clues about Exotic weapons. After leaving, try to find a ship if you don't already have one. Try digging on the two-square island near the island town of Fawn.

Make your way to the town on the island east of the Mainland. You'll recognize it by the bribable guard standing before a locked gate. You can save the \$100 bribe fee and a key by entering the maze south of the main entrance. Go north at the first place you can, then straight east as far as you can, and then north to inside the gate. Peer at a Gem, and sketch the town, using the sketch to get into the town. Go west to the locked gate. This one requires using a key. Go south to the entry on the left side of the screen. Go west to the first north possibility, west to the next south possibility, and west again. This should put you next to a guard. Bribe him, unless you are strong enough to kill off all the guards. To the west lies a treasure area, good for about \$1,100 (about \$2,000 if you have the Mark of Force). It's good to have a Thief who can grab the chests, and a Cleric who can heal him. Repeat this process until you've got quite a load of gold, say \$13,000 or so. Just be careful that you don't (C)ombine your gold hoard; give it all, say, to your second or third man, and use both your Thief and Wizard's spells to collect the loot.

Loaded with your gold and at least four keys, jump in your ship, find a whirlpool storm and enter it. You'll be cast on the shore of another island where there are four shrines. Here you can buy capability points at \$100 a pop. Peer at a Gem to get the lay of the land, and make a rough sketch. The Shrine of Strength is in the southwest corner, reached though the mountain entry way in the northwest corner. Work your way south from there. You're on the right track if you encounter two sets of wild horses. Keep going south from there. Be sure to <Pray> at each shrine.

The Shrine of Intelligence lies behind three locked gates in the north-central area. Don't bother opening up the cages. Capture the ship that's waiting for you and sail west to where you can disembark. The Shrine lies behind the third gate. You reach the Shrine of Wisdom by going north from the entry gate of the Shrine of Intelligence. Track around to another locked gate. After the initial north and east travel, work your way south and slightly east. Ignore the next locked gate you see. The Shrine of Dexterity is in the southeast area. After entering the dark area (to the right and north of your landing point), work your way northeast.

Near the initial entry into this area you'll be able to go south. Following that track gets you to the south shore of the Island, where you must capture a Pirate ship. Using yet another key, sail through the locked gate to the west and into the awaiting Whirlpool in order to get back to the point at which you initially entered the Whirlpool. Several trips between Death Gulch and Shipwreck Island should bring your attributes up to a fairly impressive level, and will certainly make your life easier.

By now you should have at least two Marks and all four Cards. You'll find the Mark of the Snake on the eighth level of the dungeon on the large island east of the Mainland. Another Mark appears on that level. If it isn't the Mark of Force which permits you to walk through force fields, you'll find it in the west end of level 8 in the dungeon surrounded by lava in the dark mountain area at the southeast end of the island. Lastly, if you want to find the Lord of Time, look in the northwest corner of level 8 in the dungeon locked in by mountains (which you can only reach via the Moon Portals).

Once you have 2,550 hit points and all eight Marks and Cards, you're ready for Ultima. "Ready" all of your party with Exotic weapons and sail up to the Snake in the center of the island on the southeast corner of the Mainland. <Yell> EZOCANE. It would be wise to make a copy of the player disk before entering the castle, as things can get rough in there. Go as far to the west as you can, walking through the Force Fields and Fire. Then head north, all the way up. As you go along you'll have several fairly tough battles. It's a good idea to negate time with a powder at the outset of each battle.

In the upper central part you'll hit three sets of invisible enemies (Floors), each of whom hit pretty hard. Use your Wizard's "P" spell or your Cleric's "O" spell. To get the rest, negate time, line your men up abreast, and march up the room, attacking forward and to the sides. Each Floor panel will only take one hit to kill when you find them. When the negate powder wears off, watch which of your guys is getting hit: he's the one nearest your foe.

Now the time has come. Move to the left of the machine that is Ultima. <Insert> Love, move right, <Insert> Sol; right, <Insert> Moons; right again and <Insert> Death. That should do it, only to whom should you "Report Thy Feat!"???

Ultima III Prophecies

Gold

- 100 You'll learn of marks and playing cards and hidden holy shrines.
- 200 Of marks there are but four—Fire, Force, Snake, King.
- 300 Learn their use in Devil Guard or death you'll surely bring.
- 400 Shrines there are but four to which you go and pray.
- 500 Their uses are innumerable and clues throughout I say.
- 600 Suits do number four, called Sol, Moons, Death, and Love.
- 700 Unto the Montors thou must go for guidance from above.
- 800 To aid thee in thy cryptic search, to dungeons thou must fare.
- 900 There seek out the Lord of Time to help you if he cares.

Bartender Tips

Gold

- 7-9 Thank you kindly.
 10 Ambrosia, ever hear of it?
 20 Dawn, the city of myths & magic.
 30 The conjunction of the moons finds link.
 40 Nasty creatures, nasty dark, sure thee ready for thee embark.
 50 None return or so I'm told from the pool dark and cold.
 60 Shrines of knowledge, shrines of strength are all but lost into the brink.
 70 Fountains fair and fountains foul all are found in dungeons bowel.
 80 Exodus: Ultima III which is next? Now could be.
 90 Seek ye out the Lord of Time and the one way is a sure find!

Village Rumors & Misty Writings

- | | |
|---|---|
| <p>Cards are useful.
 The King favors a Mark.
 Seek ye the Mark of Kings.
 You need a Mark to pass.
 Marks gained in Dungeons.
 Hot metal leaves a Mark.
 Marks are useful.
 A Mark helps invoke the snake.
 Invoke the Silver Snake.
 Conjunctions of moon finds link.
 Only exotics will protect you
 from great evil.
 Seek the Shrines of Truth.
 Seek ye the Dungeon of Fire.
 Beware the Fires of Hell.
 <Pray> for the invocation.
 <Pray> in the Circle of Light.
 Dawn Lasts but a Moment.</p> | <p><Search> for Shrines.
 <Search> the Cards.
 <Dig> Carefully.
 <Dig> up Exotics.
 <Dig> on Islands.
 Baby Bob: Bring me Bucks.
 Seek the Jester in Castle Fire.
 Jester says: West-8, South-35
 And Await the Dawn.
 Lord of Time says: Love, Sol,
 Moons, Death. All
 Else Fails.
 Circle of Light: <Yell> EZOCANE.
 Exodus is four as one.
 <Insert> Cards into Exodus.</p> |
|---|---|

Price Lists

Weapons	Armor	Objects	Sacraments
Dagger	5 B Cloth	75 Keys	50 Curing
Mace	30 C Leather	195 Torches	5/30 Healing
Sling	60 D Chain	575 Powders	90 Resurrection
Axe	125 E Plate	2500 Gems	75 Recalling
Bow	350 F +2 Chain	6130*	
Sword	200 G +2 Plate	8250*	
H Sword	250 H	Misc: Horses	4/800
+2 Axes	400 I*	Attributes 1/\$100 at each Temple.	
+2 Bows	1050 J*		
+2 Swords	800 K*		
Gloves	1200 L*		
+4 Axes	2600 M*		
+4 Bows	6550 N*		
+4 Swords	4550 O*		
Exotics	free P		

* = Available only in the Town of Dawn.

Moon Gate Destinations

Conjunction	From	To
0,0	NE Corner	NE Corner
0,1	NE Corner	Cave Island
0,2	NE Corner	3 square area
1,3	Cave Island	South Coast
1,4	Cave Island	3 square area
1,5	Cave Island	Castle
2,6	3 square area	Devil Guard
2,7	3 square area	Dungeon
2,0	3 square area	NE Corner
3,1	South Coast	Cave Island
3,2	South Coast	3 square area
3,3	South Coast	South Coast
4,4	3 square area	3 square area
4,5	3 square area	Castle
4,6	3 square area	Devil Guard
5,7	Castle	Dungeon
5,0	Castle	NE Corner
5,1	Castle	Cave Island
6,2	Devil Guard	3 square area
6,3	Devil Guard	South Coast
6,4	Devil Guard	3 square area
7,5	Dungeon	Castle
7,6	Dungeon	Devil Guard
7,7	Dungeon	Dungeon

ULYSSES AND THE GOLDEN FLEECE

1. Climb Fence. Get Coin. Don't reenter alley with Chest.
2. Talk Guard. Yes.
3. Bow. Get Chest of Gold and Silver.
4. In the Forest, Get Chest (which you won't be able to open for quite some time yet). Listen to Voice.
5. The only object you *don't* need is the Lantern!
6. Get Bottle. Get Note. Read Note (says FLEECE, spelled backwards). Give Coin. Yes. Get Map. (From Storm, Go N.N.E.S.W.S.W.S.E.N.E.N.E.E.)
7. Go Ship. Cast Off.
8. En route to Storm, Get Bag and Condor, then follow Sailing Instructions. Go Shore.
9. Clean out area. Get Bridle, Sparkling Dust (Look Hole). Get Water—the Potion of which the Voice spoke.
10. Tie Leather. To Leather. Throw Leather.
11. Give Gems (to Dragon).
12. Get Feathers (from Condor). Make Wings. With Feathers. Wax. Fly.
13. Get Rock. Get Reins. Go Hole.
14. Throw Dust.
15. Pour Wine. On Me. Return to Ship.
16. Pour Bottle. In Ocean.
17. You can avoid the Sirens, but don't. Knead Wax. Plug Ears. No. Tie Rope. To Mast. Yes. Remember Siren's Magic Word SUPPELTUEL.
18. Look Tree. Read Carving. SVENEESAS.
19. SEVENSEAS. Open Cage. Get Mallet.
20. Give Wine. Grapes. Get Trunk. Sharpen Trunk. Kill Cyclops. In Eye.
21. Kill Sheep. Make Fire. Cook Sheep. Feed Men.
22. Keep away from the Dwarf.
23. ECEELF (Opens Chest). Get Sword. Kill Skeletons. With Sword.
24. SUPPELTUEL.
25. Bridle Pegasus. Put Reins. Use Mallet. Mount Pegasus. Get Fleece. Fly. Bow (to King). Give Fleece. Win your own Kingdom and become a Level 2 Adventurer.

VOODOO CASTLE

1. Open Coffin. Take Ring. In Tunnel, Wave Ring. Get Knife. Go Chute. Take Plaque.
2. In Lab with Shield, Mix Chemicals. (Shield protects against exploding test tubes.) Get Hammer on way back.
3. Drink Chemicals. Get Saw. Look Grave. Get Four Leaf Clover. May enter Jail Cell now; need saw to get out.
4. In Chimney, Get and Clean Idol.
5. Look and Move Kettle. Go Hole. Without Idol and with Glass, in Dark Place, get safe combination. With Idol, Get Rabbit's Foot.
6. Take and Drop Heads. Turn 38. Turn 33. Get Hammer.
7. Pull Nails. Remove Boards with Hammer. Saw Grate with Saw. Drop Nails, Boards and Grate. Push Button.
8. Push Sweep. Read Paper.
9. In Parlor, Say Zap to Ju-Ju Man. Listen.
10. In Room with Plaque and with Ju-Ju Bag, Wave Bag. Go Crack. Get Missing Page.
11. Open Closed Window. Get Doll on Ledge.
12. In Chapel, look in Ju-Ju Bag. Get Stick and Book. Assemble all objects called for in Book and on Missing Page. Follow their directions in sequence. Make sure you hold either the Rabbit's Foot or the Four Leaf Clover and put the other on the Man in Coffin.

WITNESS

1. Look for changes before and after Linder's departure.
2. Responses to a given question may vary if more than one party is present at the time.
3. Use a technique comparable to one learned in *Deadline*. If you need more specific help in this regard, see item 7.
4. Once in the house, there is a way to avoid Linder's murder, but it is not the optimum solution and will cost you dearly.
5. Several key objects to look at or analyze appear at one location. Be sure to check out the clock.
6. While your Colt can (but needn't be) used, some significant changes can be wrought by the appropriate use of the handcuffs. (Handcuff her!)
7. Look around for a place to hide. Check the Sofa and Wait.

THE WIZARD AND THE PRINCESS

1. A lot of rocks South of town with which to kill the Snake; only one won't get you first, however. Starting in Town, try the Rock S.S.S.W.S. Get back to Snake with N.E.E.E.N. Whomp 'im.
2. Drink Water. (Check your starting Inventory.)
3. Look Hole. Get Cracker.
4. Take Rock. Get Magic Word HISS.
5. HOCUS (creates Bridge). As an alternate, with the Locket at the Chasm edge, Open and Examine Locket. North.
6. No, you can't stop him. Be sure to Fill Flask (with Water).
7. HISS. Go Crevice. Recover the Bread, Locket and Cracker. Unlock Door. Open Door.
8. Give Cracker. Get Vial.
9. Feed Lion. Give Bread.
10. Take Rope. Enter Boat. Fill Hole. With Blanket. Go N.N.N.E.E.E. (Drink Water, just offshore.)
11. Tie Rope. To Anchor. Throw Anchor. Climb Rope. Get Shovel.
12. Dig (with Shovel). Get Chest—momentarily.
13. Get Harp (in Chest).
14. Drink Vial. North. (Fly to another Island.)
15. Follow Rainbow. Get Coin. Don't forget the Ring.
16. Say Lucy. Cross Bridge. Recover stuff from the Cave.
17. Play Harp.
18. Buy Horn. Buying any other item results in a no-win game.
19. Play Horn.
20. If you wind up here, Feed Apple.
21. If you get zapped here, Pick Lock. With Knife. Or go back out through the maze and Open Door from the other side.
22. Go through Maze to Tower. Down. Go back Up. Rub Ring.
23. Kiss Frog.
24. Look Closet. Get and Wear Sneakers. Say WHOOSH. Zip back to Town for your just rewards.

ZORK I

1. Climb Tree. Get Jeweled Egg.
2. Open Window at West Side of House. Enter Window or West.
3. Move Rug. Get Lamp, Sword and Rope. Open Trap Door. Turn on Lamp.
4. Kill Troll. Again, until he's done in. Leave his Axe. Drop all but Lamp.
5. Get Painting. Exit Studio into Kitchen. (Can carry only two objects from Studio.) Start putting Treasures into Trophy Case, but carry the Egg so that Thief may steal it (so be sure to get it!).
6. With Rope and Lamp, Tie Rope to Rail. Climb Rope. Get Torch. Turn Off Lamp (conserve it wherever possible). Should Thief steal Torch before you get the Diamond, go to Steps 19 through 21. Otherwise, it's advantageous to have Thief steal you blind! Leave Bell, Book and Candle for now.
7. Get Coffin. Pray (at Altar). Trap Door will now stay open rather than locking shut on entry. In Clearing or Behind House, Open Coffin. Get Sceptre.
8. Wave Sceptre. Get Pot of Gold. Add Gold, Coffin and Sceptre to the Trophy Case.
9. Get All (Wrench, Screwdriver and Tube of Gunk). Push Yellow Button to enable the Console in the Lobby. The Brown Button disables it. Pushing the Blue Button will flood the joint, but gives you a few moves to get out.
10. Turn Bolt With Wrench, opening Sluice Gates. Drop Wrench.
11. Inflate Boat (With Pump). (When getting Pump, it's easier for now if you leave the Trunk and, especially, the Trident.) Launch. Wait or Look until you drift South to Buoy. Get Buoy. Land. Open Buoy. Get Emerald. Don't push your luck by going further South; it's a long way down! The Sceptre and Trident are tough on Rubber Boats, but the Tube of Gunk can Repair Boat.
12. Dig Sand With Shovel until you find Scarab. Drop Shovel. Either walk over Solid Rainbow or carry Boat to Sandy Beach. Launch. West (to White Cliffs). Park Emerald and Scarab in the Trophy Case. Head back for more with the Lamp, Torch and Matches. Temporarily drop off the Screwdriver.
13. Echo. Get Platinum. Both Platinum and Coffin are especially heavy, so that you can carry relatively fewer objects.
14. With Bell, Book and Candle from Altar area, Drop Candles, if lit. Ring Bell. Hold Candle (Light Candle with Match, if necessary). Read Book. Get Crystal Skull. Leave Bell, Book, Candle and Matches. (Use only the Matches to relight candles. Save Game and try lighting Candles with Torch or Lamp.)
15. With Lamp, Torch and Screwdriver, Drop (or just hold) Garlic in Bat Room. Leave Jade Figurine for now.
16. Put Screwdriver and Torch in Basket. Light Lamp. Don't check out the Gas Room with the Torch! Run down and Get Coal. Add it to the Basket. Lower Basket.
17. Drop All. You can now go West from the Timber Room.
18. Open Machine. Put Coal in Machine. Close Machine. Turn Switch With Screwdriver. Get Diamond. Reload Basket with everything except Screwdriver. Pick up Bracelet, Jade Figurine and Basket goodies. Slide down to Cellar and stow the treasures.
19. With Lamp, Nasty Knife (or Sword), Food, Water and Key, Get Coins. (Save Game and try throwing Rusty Knife.) Feed Cyclops the Sandwich in the Brown Bag. Give Water to Cyclops. A less elegant but more effective approach is to say ODYSSEUS. (Read the Prayer Book, and note that the first letters of each line put together spell out ODYSSEUS.)
20. Key may be used to unlock Grate from inside. Note nice touch if you have or haven't Moved Leaves, which may also be Burned or Counted.

21. Carrying Lamp, Nasty Knife (or Sword), the Jeweled Egg (if it hasn't been stolen already), and all the Treasures that you can, confront Thief in his Storeroom. Give him each of the Treasures to load and slow him down. Kill Thief. Again, until he's vanquished. Should you ever try to polish him off elsewhere, earlier in the game, save the game first, as your chances of success are slim, but finite.
22. With the Clockwork Canary (that was in the Jeweled Egg opened by the Thief's nimble fingers), Climb Tree. Wind Clockwork. Mother Song Bird will come and drop a Brass Bauble, the last of the needed points.
23. Return all Treasures to the Case. If all fifteen are stored, an ancient Parchment will appear. With it, a Secret Path can be found, and the beginnings of *Zork II* are revealed.

Treasures, Scores, and Where to Get Them

Treasure	Value (touch)	Value (case)	Where
Beautiful Painting	4	6	Gallery
Jewel Encrusted Egg	5	5	In nest in tree
Ivory Torch	14	6	Torch Room
Gold Coffin	10	15	Egyptian Room
Egyptian Sceptre	4	6	In the Coffin
Pot of Gold	10	10	End of the Rainbow
Crystal Skull	10	10	Land of Living Dead
Jeweled Scarab	5	5	Buried in Sandy Cave
Large Emerald	5	10	In the Buoy
Platinum Bar	10	5	Loud Room
Trunk of Jewels	15	5	Reservoir
Crystal Trident	4	11	Atlantis Room
Jade Figurine	5	5	Bat Room
Sapphire Bracelet	5	5	Gas Room
Huge Diamond	10	10	You create it
Bag of Coins	10	5	In the Maze
Silver Chalice	10	5	Treasure Room
Clockwork Canary	6	4	In the Egg
Brass Bauble	1	1	Songbird has it
Ancient Parchment	0	0	On Case if all treasures are in
	<hr style="width: 100%; border: 0; border-top: 1px solid black; margin-bottom: 5px;"/>	<hr style="width: 100%; border: 0; border-top: 1px solid black; margin-bottom: 5px;"/>	
	143	129	

Other Points

Getting into the house	10
Getting into the cellar	25
Getting past the Troll	5
Getting to the Torch Room	13
Getting to the Treasure Room	25
	<hr style="width: 100%; border: 0; border-top: 1px solid black; margin-bottom: 5px;"/>
	78

ZORK II

1. With Lamp, Sword, Opener, and Mat from Gazebo, Put Mat Under Door. Move Lid. Insert Opener in Keyhole. Pull Mat. Get Key. Get Opener. Unlock Door with Key. Get Blue Sphere. Drop Key and Opener. Leave Mat. (No, you can't do anything to stop the Wizard.)
2. Attack Dragon (With Sword). Don't overdo it, it could be dangerous to your health. Get his attention and move South. When he follows, whomp him again and move toward Ice Room. Repeat, moving into Ice Room. Return to Dragon's Lair.
3. Get Trunk. Follow Princess (to Gazebo). (She will open a secret door in Marble Hall.) Get Newspaper, Matches and Small Gold Key. Red Rose is nice, but of no use.
4. Drop all but Lamp and Teapot in spinning Carousel. Get Portrait, Enter Curtain. Enter South Wall. Enter Curtain. Get Bills. Enter North Wall. Leave and return. Get Bills and Portrait. Enter Curtain. When returning, Fill Teapot at Deep Ford.
5. In Riddle Room, Say "Well."
6. Get in Bucket. Pour Water (into Large Bucket). Drop Teapot. (To go down, Get and Fill Teapot.)
7. Get all but the Orange Cake. (Orange Cake will explode if you eat it.) Eat Green Cake and shrink. Enter Tiny Door. Put Red Cake in Pool. Get Candy. Leave Flask; it's poisonous and of no use to you. Go through Mousehole again and Eat Blue Cake.
8. Tell Robot East. Tell Robot Push Triangular Button. (At the now-stopped Carousel, Room 8 and the possibly useful Grue Repellent have become accessible. A Steel Box with Priceless Violin in it is now also present.) Tell Robot South.
9. Get Red Sphere. Tell Robot Lift Cage. Make sure you have Sphere.
10. With Brick, String, Paper and Matchbook, Get in Basket. Open and Put Paper in Receptacle. Light Match. Burn Paper.
11. Land (at Small Ledge). Tie Wire to Hook. Get Out. Get Zorkmid (Coin) and Rare Stamp (in Purple Book). Read White Book. Get in Basket. Untie Wire. Burn more Paper if necessary.
12. Land (at Wide Ledge). Tie Wire again. Put String in Brick. Put Brick in Hole. Light Match. Light String with Match. Leave Room and wait for explosion. Get Crown. Leave promptly, as detonation of Brick in *any* room makes it very unstable—try it, after you've saved the game. Untie Wire and Close Receptacle.
13. With Lamp, Sword (or Bat), Gold Key and both Red and Blue Spheres, Give Candy to Lizard in Guarded Room. Unlock Door with Small Gold Key.
14. Throw Sword (or Bat) at Aquarium. Don't stand too close or try it with your hands! Get Clear Sphere.
15. Put Red, Blue and Clear Spheres in their respective Stands. Get Black Sphere.
16. Put Black Sphere in Pentagram to summon Demon. Give Demon each of the ten treasures. Tell Demon Give Me the Wand, or if you're teed off with the Wiz, Tell Demon Kill Wizard, and then Get Wand. (Several fun options exist for your wish. Save Game and try, for example, to Tell Demon Kill Dog.)
17. Wave Wand at Rock. Chant Float. Get Collar.
18. The Oddly Angled Rooms (Maze) are a Baseball Diamond. Find Bat at Home Plate. (Southeast.) Run the bases SE.NE.NW.SW. Then North. Put Collar on Dog.
19. In Crypt, type Score. One more puzzle? Carrying the Wand, Turn Off Lamp! Enter the dominion of *Zork III*!!

Treasures 'n Stuff

Treasures

What	Where
Gold Statue	Dragon's Lair
Portrait	Chairman's Office
\$200 in Zorkmids	Vault
Small Gold Key	Received from Princess
Coin	Small Ledge
Rare Stamp	In Library's Purple Book
Crown	In Dusty Room's Chest
Ruby	Lava Room
Violin	In Steel Box on Carousel
Pearl Necklace	Pearl Room

Objects

What	Use
Lamp	Light. Finding Hidden Door
Sword	Teasing Dragon. Breaking Aquarium
Blue Sphere	Making Black Sphere
Red Sphere	Making Black Sphere
Clear Sphere	Making Black Sphere
Black Sphere	Summoning Demon
Teapot	Carry Water for Well
Red Rose	Nice, but nothing
Placemat	Sliding under Dreary Room Door
Letter Opener	Pushing out Key
Key	Opening Dreary Room
Matches	Lighting Papers and String
Newspaper	Making Hot Air for Balloon
String	Fuse for explosive Brick
Brick	Explosive for Box
Green Cake	Shrinks you when eaten
Blue Cake	Restores normal growth
Red Cake	Absorbs water
Orange Cake	Explodes if eaten
Flask	Not useful
Candy	Feed to Lizard
Robot	Pushing Buttons and Lifting
Collar	Tames Dog
Bat	Home Plate. Breaking Aquarium
Books (4)	Rare Stamp in Purple Book
Grue Repellent	Good for a few moves

ZORK III

1. Be trusting. Tie Chest to Rope. Wait. Hold Rope. Get Staff, don't kill him, or Staff will break.
2. Wait for Boat, Say "Hello Sailor," get Vial—an alternative aid for later.
3. Fight Shadowy Figure. When defenseless, Take Hood and Cloak, don't kill him.
4. At Lake, Drop All (save game—try taking Lamp into lake). Down, Get Amulet.
5. Indicator 1: don't need.
Indicator 2: Rub Table, Get Grue Repellent.
Indicator 3: Get Torch. Rub Table, Drop Torch.
Indicator 4: (Save game) Rub Table, spectacular death.
6. Use Grue Repellent. (Alternative: watertight chest can carry the Lantern.)
7. Get Key. Lift Cover. Cross Viaduct, which collapses in earthquake around turn 130. (Alternative: after earthquake, use Grue Repellent, get Key, return to Southern Shore immediately. There is just enough life in the Repellent.)
8. If Old Man isn't there, leave and return later. Wake and Give Bread. Open Door.
9. Break Beam by dropping any object. Go South and Push Button.
10. Enter Mirror. Lift Short Pole. Push Red Panel until Compass points North. Lower Short Pole. Push Mahogany until room stops. Lift Short Pole. Push Red until Compass points South. Push Pine Panel and exit North to Wizard's Door. Knock and get Magic Word "Frotz Ozmo". All but Lamp may be temporarily dropped in Engraving Room. (Alternative: drinking the liquid in the Vial produces one-to-two move invisibility, just long enough to get by the Guardians.)
11. After earthquake, tackle Royal Puzzle (see below). Get Book, don't drop it in slot, which will get you out but leave you in a no-win situation.
12. Push Gold Machine into Jewel Room. Sit on Seat. Turn Dial to 776. Push Button. Take Ring. Listen to Guards until they leave. Go to Museum. Hide Ring under Seat. Turn Dial to 948. Push Button. Stand Up. Retrieve your objects in Jewel Room. (By now, you should have all 7 points and the Staff, Hood/Cloak, Key, Amulet, Book, Ring and Lamp.
13. Turn Dial to 4. Push Button. Turn Dial to any other number. Tell Dungeon Master to stay. Go into Prison Cell.
14. Tell Dungeon Master to Push Button. Unlock Bronze Door with Key and enter the Treasure Vault of Zork!

One Solution to Royal Puzzle

(39 Moves)

(PSW=Push South Wall, etc.)

- | | |
|---------------|-----------|
| 1) Down | 17) PSW |
| 2) PEW | 18) PSW |
| 3) W | 19) PSW |
| 4) PSW | 20) PEW |
| 5) E.SE.NE.N | 21) S |
| 6) PEW | 22) PWW |
| 7) SW.S | 23) SW |
| 8) PSW | 24) PNW |
| 9) Get Book | 25) PNW |
| 10) PSW | 26) NE |
| 11) PWW | 27) PWW |
| 12) S | 28) SW |
| 13) PEW | 29) PNW |
| 14) NE.NE.N.N | 30) PNW |
| 15) PWW | 31) NW.Up |
| 16) NW | |

Point Awards—Seven Maximum

(Easy to get and have winless situation)

- | | |
|-----------------------------|---------------------------------|
| 1. Getting to Chest | 5. Rubbing Table |
| 2. Meeting Shadowy Figure | 6. Pushing Wall in Royal Puzzle |
| 3. Attacking Shadowy Figure | 7. Time Travel to 776 |
| 4. Entering Lake | |

Game Versions Available	Apple II	Apple II+	Apple IIe	Apple III Emulation Mode	IBM PC	IBM PCjr	Atari	Commodore 64	TRS-80	TRS-80 Color Computer	TI-99	Northstar Advantage	Horizon	Epson QX-10	HP 150	Dec Rainbow	Dec Mate	Kaypro II
	Adventure (Various Companies)	•	•	•	•		•		•									
Adventureland (Adventure International)	•	•	•			•		•		•	•	•						
Adventure in Time (Phoenix Software)	•	•	•			•												
Ali-Baba & 40 Thieves (Quality Software)	•	•	•			•												
Beneath Apple Manor (Quality Software)	•	•	•	•		•												
Birth of the Phoenix (Phoenix Software)	•	•	•			•												
Blade of Blackpoole (Sirius)	•	•	•			•	•											
Castle of Darkness (The Logical Choice)	•	•	•	•														
Chambers of Xenobia (Avant-Garde Creations)	•	•	•															
Count (Adventure International)	•	•	•			•		•		•	•	•						
Coveted Mirror (Penguin Software)	•	•	•															
Cranston Manor (Sierra On-Line Systems)	•	•	•															
Creature Venture (Highland)	•	•	•															
Crime Stopper (Hayden Software)		•	•															
Crypt of Medea (Sir-Tech Software, Inc.)	•	•	•	•														
Crystal Caverns (Hayden Software)		•	•															
Curse of Crowley Manor (Adventure International)	•	•	•		•			•										
Cyborg (Sentient Software)	•	•	•	•	•	• ¹	•											•
Dark Crystal (Sierra On-Line Systems)	•	•	•	•		•												

1 - Model 800

2 - Models I & II

Game Versions Available	Apple II	Apple II+	Apple Iie	Apple III Emulation Mode	IBM PC	IBM PCjr	Atari	Commodore 64	TRS-80	TRS-80 Color Computer	TI-99	Northstar Advantage	Horizon	Epson QX-10	HP 150	Dec Rainbow	Dec Mate	Kaypro II
	Deadline (Infocom)	•	•	•	•	•	•	•	• ²	•						•	•	•
Death in the Caribbean (Microlab)	•	•	•				•											
Demon's Forge ⁴ (Saber Software)	•	•	•															
Doom Valley (Superior Software)	•	•	•															
Earthquake—S.F. 1906 (Adventure International)	•	•	•		•				•									
Empire of the Overmind (Avalon Hill)	•	•	•			•		•										
Enchanter (Infocom)	•	•	•	•	•	•	•	• ²		•					•	•	•	
Escape from Traam (Adventure International)	•	•	•			•			•									
Fantasyland-2041 AD ⁴ (Crystalware)	•	•	•															
G.F.S. Sorceress (Avalon Hill)	•	•	•			•		•										
Ghost Town (Adventure International)	•	•	•			•		•		•	•	•						
Golden Voyage (Adventure International)	•	•	•			•		•		•	•	•						
Gruds in Space (Sirius)	•	•	•			•	•											
Infidel (Infocom)	•	•	•	•	•	•	•	• ²		•					•	•	•	
Kabul Spy (Sirius)	•	•	•															
Knight of Diamonds (Sir-Tech Software)	•	•	•	•														
Labyrinth of Crete (Adventure International)	•	•	•			•												
Legacy of Llylgamyn (Sir-Tech Software, Inc.)	•	•	•	•														
Madventure ³ (Microlab)	•	•	•															

3 - Discontinued

4 - No information available except for Apple Models

Game Versions Available

	Apple II	Apple II+	Apple IIe	Apple III Emulation Mode	IBM PC	IBM PCjr	Atari	Commodore 64	TRS-80	TRS-80 Color Computer	TI-89	Northstar Advantage	Horizon	Epson QX-10	HP 130	Dec Rainbow	Dec Mate	Kaypro II
Mask of the Sun (Ultrasoft)	•	•	•															
Mission Asteroid (Sierra On-Line Systems)	•	•	•			•												
Mission Impossible (Adventure International)	•	•	•			•		•		•	•	•						
Mummy's Curse (Highland)	•	•	•															
Mystery Fun House (Adventure International)	•	•	•			•		•		•	•	•						
Mystery House (Sierra On-Line Systems)	•	•	•															
Oldorf's Revenge (Wizard I) (Highland)	•	•	•															
Oo-topos (Sentient)	•	•	•															
Queen of Phobos (Phoenix Software)	•	•	•															
Quest (Penguin Software)	•	•	•															
Palace in Thunderland ³ (Microlab)	•	•	•															
Pirate Adventure (Adventure International)	•	•	•			•		•		•	•	•						
Planetfall (Infocom)	•	•	•	•	•	•	•	•		•					•	•	•	
Pyramid of Doom (Adventure International)	•	•	•			•		•		•	•	•						
Sands of Egypt (Datamost)		•	•	•		•		•										
Savage Island I (Adventure International)	•	•	•			•		•		•	•	•						
Savage Island II (Adventure International)	•	•	•			•		•		•	•	•						
Secret Agent (Jor-And)	•	•	•	•	•													
Serpent's Star (Ultrasoft)	•	•	•															

3 - Discontinued

Game Versions Available

	Apple II	Apple II+	Apple IIe	Apple III Emulation Mode	IBM PC	IBM PCjr	Atari	Commodore 64	TRS-80	TRS-80 Color Computer	TI-80	Northstar Advantage	Horizon	Epson QX-10	HP 150	Dec Rainbow	Dec Mate	Kaypro II
Sherwood Forest (Phoenix Software)	•	•	•															
Softporn Adventure ³ (On-Line Systems)	•	•	•															
Sorcerer (Infocom)	•	•	•	•	•	•	•	•	•	•								
Starcross (Infocom)	•	•	•	•	•	•	•	• ²	•							•		
Strange Odyssey (Adventure International)	•	•	•		•		•	•	•	•	•							
Suspended (Infocom)	•	•	•	•	•	•	•	• ²	•							•	•	•
Time Zone (Sierra On-Line Systems)	•	•	•															
Transylvania (Penguin Software)	•	•	•			•												
Ulysses (Sierra On-Line Systems)	•	•	•	•		•												
Ultima I (Calif. Pac. Company)	•	•	•	•			•											
Ultima II (Sierra On-Line Systems)	•	•	•	•		•	•											
Ultima III (Origin Systems)	•	•	•			•	•											
Voodoo Castle (Adventure International)	•	•	•			•		•	•	•	•							
Witness (Infocom)	•	•	•	•	•	•	•	• ²	•									
Wizard & the Princess (Sierra On-Line Systems)	•	•	•			•												
Wizardry (Sir-Tech Software)	•	•	•	•														
Zork I (Infocom)	•	•	•	•	•	•	•	• ²	•							•	•	•
Zork II (Infocom)	•	•	•	•	•	•	•	• ²	•							•	•	•
Zork III (Infocom)	•	•	•	•	•	•	•	• ²	•							•	•	•

2 - Models I & II
3 - Discontinued

VENDORS

Adventure International
P.O. Box 3435
Longwood, FL 32759
Phone: 305-862-6917

Avalon Hill Game Co.
4517 Hartford Rd.
Baltimore, MD 21214
Phone: 301-254-5300

Avant-Garde Creations
P.O. Box 30160
Eugene, OR 97403
Phone: 503-345-3043

California Pacific Computer Co.
1205 Drake Drive, Suite D
Davis, CA 95616-0819

Crystalware
Address Unavailable

Datamost, Inc.
8943 Fullbright Ave.
Chatsworth, CA 91311
Phone: 213-709-1202

Hayden Book Company
10 Mulholland Dr.
Hasbrouck Heights, NJ 07604
Phone: 201-393-6000

Hayden Software
600 Suffolk
Lowell, MA 08153
Phone: 617-937-0200

Highland Computer Services
8008 Gerard Ave.
La Jolla, CA 92037
Phone: 619-454-5079

Infocom, Inc.
55 Wheeler St.
Cambridge, MA 02138
Phone: 617-492-1031

Jor-And
P.O. Box 9180
Glendale, CA 91206
Phone: 213-247-6658

Logical Choice, The
9200 Baltimore National Pike
Elliot City, MD 21043
Phone: 301-465-3175

Micro Lab
2699 Skokie Valley Rd.
Highland Park, IL 60035
Phone: 312-433-7550

Origin Systems, Inc.
P.O. Box 58009
Houston, TX 77258
Phone: 713-333-2539

Penguin Software
830 4th Ave.
Geneva, IL 60134
Phone: 312-232-1984

Phoenix Software, Inc.
64 Lake Zurich Dr.
Lake Zurich, IL 60047
Phone: 312-438-4850

Quality Software
21601 Marilla
Chatsworth, CA 91311
Phone: 213-344-6599

Saber Software
Address unavailable

Sentient Software
P.O. Box 4929
Aspen, CO 81612
Phone: 303-925-9293

Sir-Tech Software, Inc.
6 Main St.
Ogdensburg, NY 13699
Phone: 315-393-6633

Sirius Software
10364 Rockingham Dr.
Sacramento, CA 95827
Phone: 916-366-1195

Superior Software, Inc.
4312 Arizona Ave.
Kenner, LA 70065
Phone: 504-468-2273

Ultrasoft, Inc.
13503 Bell-Red Road, Suite 200
Bellevue, WA 98005
Phone: 206-451-8104

THE BOOK DIVISION

Order #	Title	Price
1	The Book of Apple Software 1985 800 pages of no-holds-barred software reviews.	\$24.95
2	The Book of Apple Macintosh Software 1985* Introductions and software reviews especially for the Macintosh.	\$14.95
3	The Book of IBM Software 1985 Reviews over a 600 programs for the IBM PC.	\$19.95
4	The Book of Commodore Software 1985 Hundreds of software reviews for the Commodore 64.	\$19.95
5	The Book of Atari Software 1985* Reviews galore of hundreds of the most popular Atari programs.	\$19.95
6	The Portable Computer Book Introduces computers and evaluates almost 100 transportable computers. <i>James E. Balmer & Matthijs Moes.</i>	\$19.95
7	The Book of Adventure Games Reviews, maps, and hints for dozens of the most popular adventure games. <i>Kim Schuette.</i>	\$19.95
8	Commodore 64 Color Graphics: A Beginner's Guide Instructions in BASIC for inexperienced programmers. <i>Shaffer & Shaffer Applied Research & Development.</i>	\$14.95
9	Commodore 64 Color Graphics: An Advanced Guide Combining machine language routines with your BASIC programs. <i>Shaffer & Shaffer Applied Research & Development.</i>	\$14.95
10	Commodore 64 Arcade Game Design Instructions and sample programs for writing fast, colorful arcade games. <i>James Favour.</i>	\$16.95
11	Atari Color Graphics: A Beginner's Workbook Sample BASIC programs, illustrations, and instructions for all Atari computers. <i>Joseph W. Collins.</i>	\$12.95
12	Atari Graphics and Arcade Game Design Pages and pages of instructions and sample machine language programs. <i>Jeffrey Stanton.</i>	\$16.95
13	Apple Graphics and Arcade Game Design Machine language programming for fast arcade games on Apple computers. <i>Jeffrey Stanton.</i>	\$19.95
14	Apple IIc/IIe Beginning Graphics* Easy-to-understand instruction in graphics programming. <i>Shaffer & Shaffer Applied Research and Development.</i>	\$16.95
15	Apple IIc/IIe Advanced Graphics* Graphics for the experienced programmer. <i>Shaffer & Shaffer Applied Research and Development.</i>	\$16.95
16	MacArt: Using MacPaint and MacWrite* Fully illustrated instruction in using these most popular Macintosh programs. <i>Shaffer & Shaffer Applied Research and Development.</i>	\$16.95
17	Interactive Video Primer: A Practical Approach* An introduction to this new, exciting technology by experts in the field. <i>Del Smith Penny and Jackie Baldwin.</i>	\$14.95
18	Exceeding Expectations: The Businessman's Guide to Choosing the Right Computer System Introduction to computers and how they are best used in business. <i>W. J. Kaydos</i>	\$14.95
19	The Insider's Guide to Buying a Personal Computer* Tips, hints, and hard facts from leaders in the microcomputer industry. <i>Isaac Malitz, Ph.D. and James D. Sadlier.</i>	\$14.95
20	Connections: The Micro-Communications Guidebook* The nuts and bolts of putting your computer in the middle of the communications revolution. <i>Michael Mellin, Ph.D., and Michael Mikus.</i>	\$14.95
21	The Home Accountant Desk Reference Tips and suggested uses for this most popular home financial program. <i>Steve Golding & Chris Kormann.</i>	\$14.95
22	Personal Financial Planning with the Home Accountant Helps you turn this best selling program into a total personal productivity tool. <i>Steve Adams.</i>	\$16.95
	The User's Encyclopedias Entries explain operating system, machine language, BASIC, and special commands, software, hardware, and helpful hints you won't find anywhere else. Alphabetically arranged.	
23	<i>The Apple User's Encyclopedia (II, II+, IIe, III)</i>	\$19.95
24	<i>The Commodore 64 User's Encyclopedia</i>	\$14.95
25	<i>The Commodore Vic 20 User's Encyclopedia</i>	\$14.95
26	<i>The Atari User's Encyclopedia</i>	\$19.95
27	<i>The TRS-80 User's Encyclopedia (Color Computer and MC-10)</i>	\$14.95
28	<i>The TRS-80 User's Encyclopedia (Models I, III, and 4)</i>	\$19.95
29	<i>The TRS-80 User's Encyclopedia (Model 100)</i>	\$14.95
30	<i>The Texas Instruments User's Encyclopedia (TI-99/2, 4, 4A)</i>	\$14.95
31	<i>The Timex/Sinclair User's Encyclopedia (TS1000, TS2068, ZX81)</i>	\$14.95
32	MacReference* A special User's Encyclopedia for this special computer. <i>Michael Mellin, Ph.D. & Andy Klein.</i>	\$19.95
33	The Quick and Easy Guide to: Word Processing with the IBM PC Introduction to word processing, reviews of popular programs, and detailed comparison chart. <i>David Lansing.</i>	\$ 4.95
34	The Quick and Easy Guide to: Spreadsheets on the IBM PC Explains the theory modeling and reviews almost forty popular spreadsheet programs. <i>Tom Simondi.</i>	\$ 4.95
35	The Quick and Easy Guide to: File Management on the IBM PC Explains how file managers work and how you can use them, and reviews several best selling programs. <i>Evan Lim and Amy Woodis.</i>	\$ 4.95
36	The Quick and Easy Guide to: Database Management on the IBM PC What databases do and how they can do it for you. Reviews of many important database programs. <i>Evan Lim and Amy Woodis.</i>	\$ 4.95
37	The Quick and Easy Guide to: Educational Software on the Apple, Elementary and Early Childhood The concepts behind education using computers, tips on selecting software, and over 100 reviews. <i>Stephen J. Taffee, Ph.D. & Andrew J. Keogh, Ed.D.</i>	\$ 4.95
38	The Quick and Easy Guide to: Educational Software on the Apple, Secondary and Adult What to look for when selecting educational software and reviews of over 100 programs. <i>Stephen J. Taffee, Ph.D. & Andrew J. Keogh, Ed.D.</i>	\$ 4.95

39	The Quick and Easy Guide to: Word Processing on the Apple <i>Introduction to word processing and Apple computers, and reviews of popular programs.</i> Steve Adams.	\$ 4.95
40	The Quick and Easy Guide to: Spreadsheets on the Apple Introduction to computer modeling and reviews of many popular spreadsheet programs. Tom Simondi.	\$ 4.95
41	The Quick and Easy Guide to: Database Management on the Apple* Introduction to database programs and their uses, and reviews of many popular programs.	\$ 4.95

CONTINENTAL SOFTWARE

Home Productivity Software (Available for Apple, IBM, Atari, and Commodore. Check with your dealer or Arrays, Inc./Continental Software for other versions.)		
The Home Accountant The #1 bestselling home finance package. The best way to organize and maintain your financial records.		
42	Home Accountant (Apple Expanded, Apple IIe, Atari, Commodore 64, IBM PCjr, and TRS-80)	\$ 74.95
43	Home Accountant Plus (IBM and TI Pro)	\$150.00
44	Home Accountant Plus (Epson, Kaypro, and Osborne)	\$ 99.95
45	Home Accountant for the Macintosh	\$149.95
46	The Tax Advantage This bestselling income tax program works year-round with the Home Accountant for tax planning and preparation.	\$ 69.95
47	The Home Cataloger Catalog anything you own—books, wine, household items. Comes with 10 ready-to-use catalog formats.	\$ 49.95
F.C.M. This versatile mailing list program prints custom labels and works with popular word processing programs to produce customized form letters.		
48	F.C.M. for Apple	\$ 99.95
49	F.C.M. for IBM and TI Pro	\$124.95
50	F.C.M.jr (for IBM PCjr)	\$ 74.95
51	F.C.M. for Commodore 64	\$ 49.95
52	Learn to Type* A newer and better way to improve your typing skills. Includes built-in mini-word processing program, choice of QWERTY or Dvorak keyboards.	\$ 49.95
53	Phone Call* Innovative, affordable telecommunications for the Commodore 64.	\$ 49.95
Get Rich Series: * Teaches basic money management skills and offers a range of financial solutions tailored to individual needs. (Available for Apple, Atari, IBM, and Commodore 64. Check with your dealer or Arrays, Inc./Continental Software for other versions.)		
54	Volume 1—Get Rich: Strategies	\$ 49.95
55	Volume 2—Get Rich: Real Estate Planning	\$ 49.95
56	Volume 3—Get Rich: Insurance Planning	\$ 49.95
57	Volume 4—Get Rich: Retirement and Estate Planning	\$ 49.95

58	UltraFile Powerful database incorporating filing, custom reports, and graphing. IBM, PC/XT, Compaq, and TI Pro.	\$195.00
59	Property Management Complete, flexible package that simplifies daily recordkeeping for property managers and owners. IBM, PC/XT, Compaq, Wang PC, and TI Pro. The CPA Series: Computer Programmed Accountant Fully integrated or stand-alone accounting programs for small to medium sized businesses. (Available for Apple II/IIe only.)	\$495.00
60	Module 1—General Ledger	\$250.00
61	Module 2—Accounts Receivable	\$250.00
62	Module 3—Accounts Payable	\$250.00
63	Module 4—Payroll	\$250.00

* Available in 1985. Call or write Arrays, Inc. Product Information for book publishing dates or release dates of software for your computer.

Arrays, Inc.
11223 S. Hindry Avenue
Los Angeles, CA 90045
(213) 410-3977

Prices subject to change without notice.

ORDER FORM

Order Number	Computer Model (Software)	Product Title	Quantity	Unit Price	Total Price

SubTotal _____

California Sales Tax 6½% _____

TOTAL ENCLOSED _____

NAME _____

ADDRESS _____

CITY, STATE, ZIP _____

PHONE # _____

Visa MasterCard Check or Money Order

Bank Card No. _____

Expiration Date: _____

Signature: _____

Mail to:

**Arrays, Inc.
Order Department
11223 S. Hindry Avenue
Los Angeles, CA 90045**

\$19.95
U.S.A.

THE BOOK OF
ADVENTURE
GAMES

Once upon a time (isn't that the way the best literature starts?), when 16K computers were still the size of a house, there were adventure games. Since then, the two have evolved together. Computers are now more powerful and sophisticated, and adventure games offer greater stimulation, delight, and challenge than ever before.

Adventure games can excite the imagination, but they can be frustrating too. If all you need is just a hint or peek at a map to help you come unstuck, help lies between these covers.

The Book of Adventure Games takes the frustration—not the challenge—out of playing adventure games. It provides evaluations, maps, illustrations, and clues for over 75 of the most popular games available on the Apple and other computers. Adventurers of all skill levels looking for that specific answer to speed them on their way will find just the hint needed to keep playing. Maps and hints are presented in a way that offers help *without* giving away the whole game and ruining it for you.

This book won't tell you everything—just everything you need.

ARRAYS, INC.
THE BOOK DIVISION

ISBN 0-912003-08-1