

# DOT MATRIX PRINTER OPTION

**user manual**

**INTELLIGENT  
SERIAL INTERFACE**

**EPSON**

### NOTICE:

- \* All rights reserved. Reproduction of any part of this manual in any form whatsoever without EPSON's express written permission is forbidden.
- \* The contents of this manual are subject to change without notice.
- \* All efforts have been made to ensure the accuracy of the contents of this manual. However, should any errors be detected, EPSON would greatly appreciate being informed of them.
- \* The above notwithstanding, EPSON can assume no responsibility for any errors in this manual or their consequences.

© Copyright 1983 by EPSON CORPORATION  
Nagano, Japan

## TABLE OF CONTENTS

INTRODUCTION.....	1
SPECIFICATIONS .....	2
CONDITION SETTING.....	4
INSTALLATION .....	8
HARDWARE DESCRIPTION .....	18
PARTS LIST .....	28

# INTRODUCTION

The Intelligent Serial Interface (with the 2K buffer) (Cat. No. 8148) is an interface for serial data communication, which incorporates a CPU and is provided with general-purpose serial interface functions.

The 8148 is an optional interface intended for use in the EPSON FX and RX Series Dot Matrix Printers.

Under the interface conditions of RS-232C or 20 mA current loop, this interface can be applied to asynchronous serial data transmission systems with a bit rate ranging from 75 to 19,200 BPS under X-ON/X-OFF control or Reverse channel control.

# SPECIFICATIONS

- (1) Synchronizing Method: Asynchronous
- (2) Bit Rate: 75 to 19,200 BPS:  
75, 110, 134.5, 150, 200, 300, 600, 1,200, 1,800,  
2,400, 4,800, 9,600, or 19,200 (selectable by operator)
- (3) Word Length
- 1) Start bit: 1 bit
  - 2) Data bit: 7 or 8 bits (selectable by operator)
  - 3) Parity bit: Odd, even or none (selectable by operator)
  - 4) Stop bit: 1 bit or more
- (4) Input Signal Polarity
- 1) With RS-232C: MARK = logic "1" (-3 to -27V)  
SPACE = logic "0" (+3 to +27V)
  - 2) With Current Loop: MARK = logic "1" (current ON)  
SPACE = logic "0" (current OFF)
- (5) Handshaking

Control	Flag control		X-ON/X-OFF control		
	Interface	RS-232C	Current loop	RS-232C	Current loop
Data entry enabled		When pin Nos. 11 and 20 of interface connector is in SPACE state.*	When impedance across pin Nos. 17 and 24 of interface connector is LOW.*	When X-ON <11> <sub>H</sub> signal is sent from pin No. 2 of interface connector.	When X-ON <11> <sub>H</sub> signal is sent across pin Nos. 17 and 24 of interface connector.
Data entry disabled		When pin Nos. 11 and 20 of interface connector is in MARK state.*	When impedance across pin Nos. 17 and 24 of interface connector is HIGH.*	When X-OFF <13> <sub>H</sub> signal is sent from pin No. 2 of interface connector.	When X-OFF <13> <sub>H</sub> signal is sent across pin Nos. 17 and 24 of interface connector.

\*Signal polarity can be inverted by DIP SW pin No. 1-4 setting.

**NOTES:**

1. Meanings of LOW and HIGH impedances in Current Loop Interface by Flag Control.

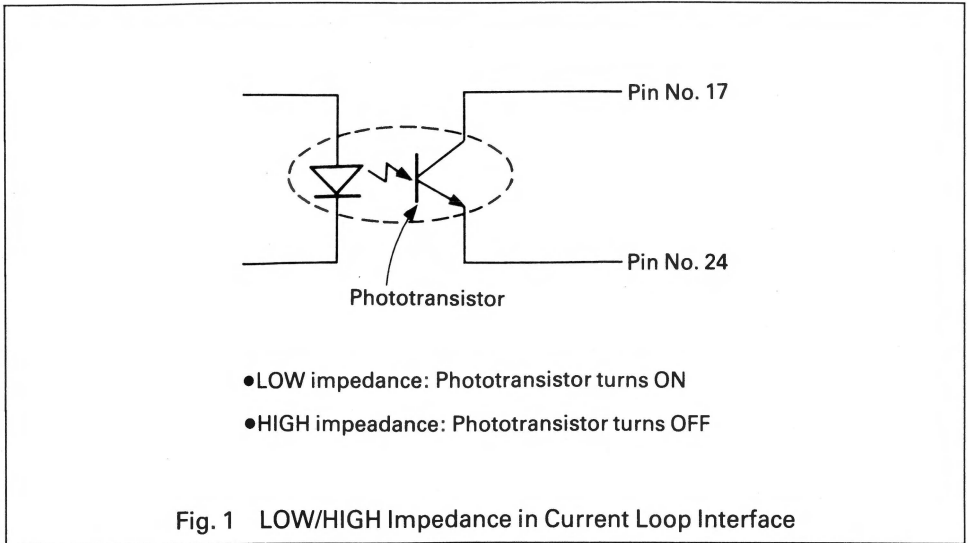

2. About the voltage across pin Nos. 17 and 24 in Current Loop Interface  
Since the withstand voltage of the phototransistor shown above is 27V, be careful not to apply a voltage of more than 27V to pin Nos. 17 and 24.

# CONDITION SETTING

The Intelligent Serial Interface (Cat. No. 8148) has two DIP switches and 16 jumpers on its board, to permit selection of various conditions by the user. The function and factory-set condition of each jumper and DIP switch pin are as shown below.

## 1. DIP Switch Setting

### 1.1 Functions and conditions of DIP switches

Table 1 Setting of DIP SW1

SW pin No.	Function	ON	OFF	Factory-set condition
1-1	Word length selection	7 bits	8 bits	OFF
1-2	Parity check enable/disable selection	Enable	Disable	OFF
1-3	Even/odd parity selection	Even	Odd	OFF
1-4	Flag positive/negative polarity selection	Negative (NOTE 1)	Positive (NOTE 2)	OFF
1-5	Bit rate selection	See Table 3.		OFF
1-6				OFF
1-7				OFF
1-8				OFF

#### NOTES:

1. Negative:

Data Entry Enabled  
Data Entry Disabled

Reverse Channel OFF (-3V to -27V)  
Reverse Channel ON (+3V to +27V)

2. Positive:

Data Entry Enabled  
Data Entry Disabled

Reverse Channel ON (+3V to +27V)  
Reverse Channel OFF (-3V to -27V)

**Table 2 Setting of DIP SW2**

SW pin No.	Function	ON	OFF	Factory-set condition
2-1	I/F board enable/disable (NOTE 1)	Enable	Disable	ON
2-2	Buffer operation enable/disable	Enable	Disable	ON
2-3	Flag reset timing 1	See Table 4. (NOTE 2)		OFF
2-4	Flag reset timing 0			OFF
2-5	Self-test enable/disable	Enable	Disable	OFF
2-6	Self-test mode selection	Line monitor	Loopback	OFF

**NOTES:**

1. The I/F board operates when this DIP SW pin 2-1 is ON, and does not operate when this DIP SW pin 2-1 is OFF. As output impedance of the I/F board becomes high when DIP SW pin 2-1 is OFF, the parallel interface of the printer can be used with this I/F board connected.
2. Select flag reset timing shown in Fig. 18.



## 1.2 Bit rate selection

Table 3 Bit Rate Selection

Bit rate (BPS)	DIP SW pin			
	SW1-5	SW1-6	SW1-7	SW1-8
75	ON	ON	ON	ON
110	ON	ON	ON	OFF
134.5	ON	ON	OFF	ON
150	ON	ON	OFF	OFF
200	ON	OFF	ON	ON
300	ON	OFF	ON	OFF
600	ON	OFF	OFF	ON
1,200	ON	OFF	OFF	OFF
1,800	OFF	ON	ON	ON
2,400	OFF	ON	ON	OFF
4,800	OFF	ON	OFF	ON
9,600	OFF	ON	OFF	OFF
19,200	OFF	OFF	ON	ON

**NOTE:**  
 Combinations other than those shown above will be taken as 19,200 BPS.  
 In the Current Loop mode, data transfer operation cannot be guaranteed at bit rate settings exceeding 1,200 BPS.

## 1.3 Flag reset timing selection

Table 4 Flag Reset Timing Selection

Vacant area for bytes in the print buffer	DIP SW Pin No.	
	SW2-3	SW2-4
152	OFF	OFF
288	OFF	ON
560	ON	OFF
1,936	ON	ON

## 2. Jumper Setting

Table 5 Setting of Jumpers

Jumper	Function	Factory-set condition
J1	ON: Pull up "TTY-TXD" to +12V via 470-ohm resistor (See NOTE 1.)	OFF
J2	ON: Connect "TTY-TXD Return" to Signal Ground (See NOTE 1.)	OFF
J3	ON: Connect "TTY-TXD Return" to Signal Ground (See NOTE 1.)	OFF
J4	ON: Pull up "TTY-TXD" to +12V via 470-ohm resistor (See NOTE 1.)	OFF
J5	ON: Pull up "DSR" to +12V	ON
J6	ON: Pull up "DCD" to +12V	OFF
J7A	ON: 8K-byte RAM is used. (See NOTE 2.)	OFF
J7B	ON: 2K-byte RAM is used. (See NOTE 2.)	
J8B	ON: Send X-ON/X-OFF signal OFF: Do not send X-ON/X-OFF signal	ON
J8A	—	ON
J9A	ON: $\mu$ PD7811 is used as CPU. (See NOTE 3.)	OFF
J9B	ON: $\mu$ PD7810 is used as CPU. (See NOTE 3.)	ON
JX	ON: X-ON/X-OFF control is used for handshaking in Current Loop mode. (See NOTE 4.)	OFF
JF	ON: Flag control is used for handshaking in Current Loop mode. (See NOTE 4.)	ON
JCL	ON: Receive data in Current Loop mode. (See NOTE 5.)	OFF
JRS	ON: Receive data in RS-232C mode. (See NOTE 5.)	ON

### NOTES:

1. If the host computer is not equipped with the power supply for the Current Loop interface, these jumpers must be connected to perform communication via the Current Loop interface.
2. Either J7A or J7B jumper must be connected. Since the interface board is factory-set to use the 2K-byte RAM, J7B is connected by a printed pattern.  
Cut this pattern and connect J7A jumper if the 8K-byte RAM is to be used.
3. Either J9A or J9B jumper must be connected. Note that the  $\mu$ PD7811 incorporates a mask ROM, while the  $\mu$ PD7810 is not provided with an internal ROM and is operated by an external ROM.
4. JX and JF jumpers cannot be connected at the same time.
5. JRS and JCL jumpers cannot be connected at the same time.
6. "ON" denotes the connection of the jumper, while "OFF" denotes the disconnection of the jumper.

# INSTALLATION

## 1. Installing the Interface Board in FX Series Printer

To install the Intelligent Serial Interface Board (Cat. No. 8148) in an FX Series printer, observe the following procedure.

- (1) Turn off the power switches of both the printer and the host computer.

**NOTE:**

Power should always be turned off when inserting or removing the interface board. Removal or insertion of the interface board with the power turned on could cause permanent damage to the board itself, as well as to the printer and the host computer.

- (2) Pull and remove the manual paper feed knob.
- (3) Remove the four screws shown in Fig. 2.

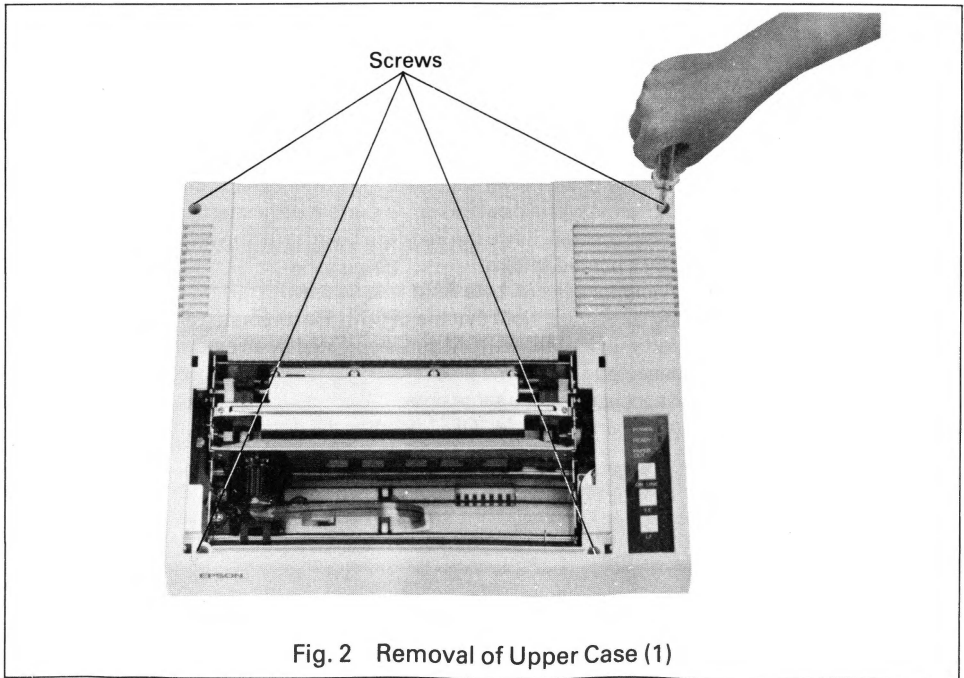

Fig. 2 Removal of Upper Case (1)

- (4) Lift the upper case of the printer, unplug the cable connector connecting the control panel and the control circuit board from the control circuit board. (See Fig. 3.)

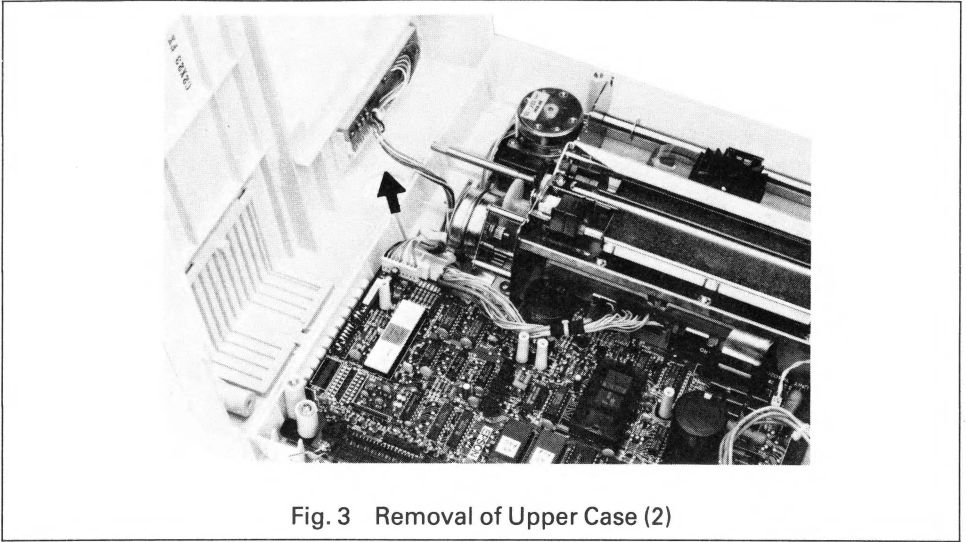

Fig. 3 Removal of Upper Case (2)

- (5) Remove the upper case and the shield cover. After the upper case has been removed, four poles are visible at the inner rear left of the printer. (See Fig. 4.)

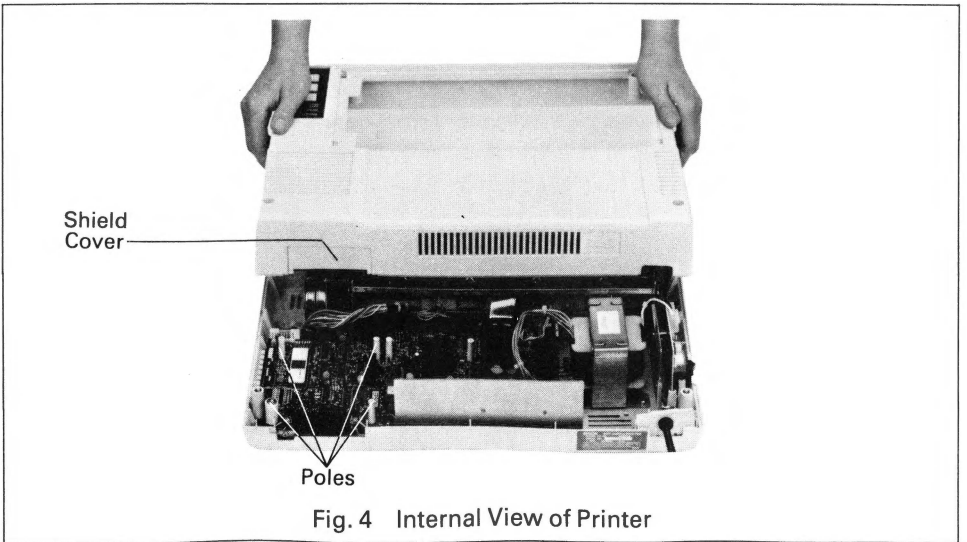

Fig. 4 Internal View of Printer

(6) Loosen the screw set in the FG (frame ground) pattern.

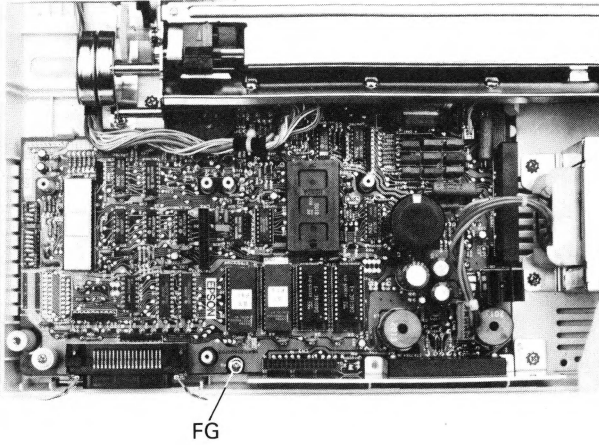

Fig. 5 Loosening the Screw

(7) Connect one end of the frame ground wire (Round Chip) contained in the shipping package of this interface as an accessory to the frame ground terminal. (See Fig. 6.)

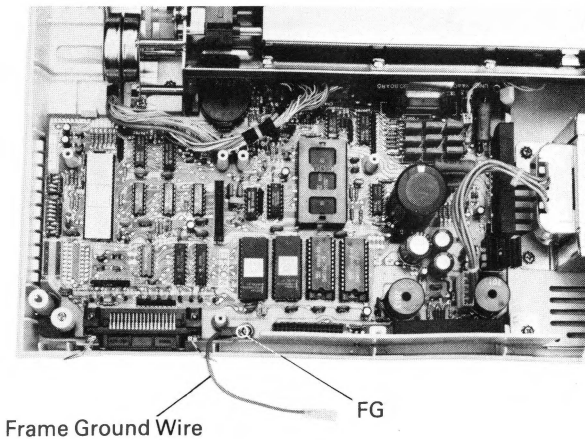

Fig. 6 Connecting Frame Ground Wire

- (8) Plug the connector of the Intelligent Serial Interface Board (Cat. No. 8148) into the mating connector (CN2) on the control circuit board of the printer.
- (9) Secure the Serial Interface Board on the four poles with the four mounting screws. (See Fig. 7.)

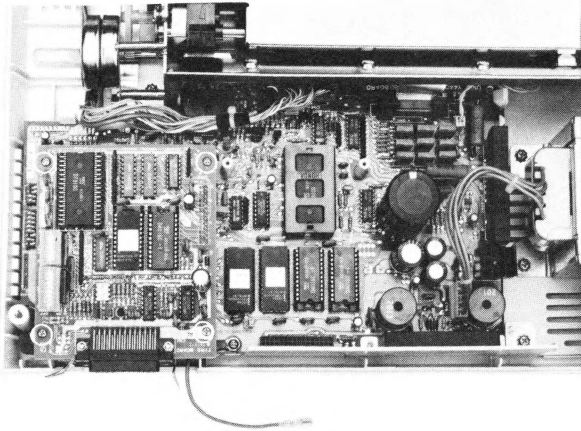
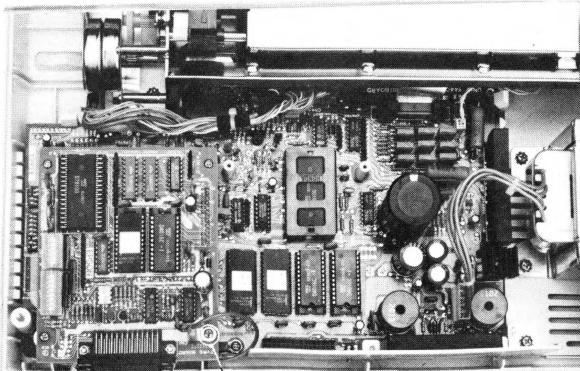

Fig. 7 Mounting the Intelligent Serial Interface Board

- (10) Connect the Frame Ground wire (FASTON chip) to the FG terminal (FASTON tab) of the Interface Board (Cat. No. 8148). (See Fig. 8.)



FG Terminal

Fig. 8 Connection of FG Wire to FG Terminal

- (11) Replace the upper case.

Two types of FX Series printer are available. One type incorporates a SUMI Board for carriage control and the other type, a Slave CPU 8042 for this purpose. Both types are fully compatible. Observe the following procedures to install the Intelligent Serial Interface Board in a FX Series printer incorporating a SUMI Board.

Remove the upper case and the shield cover in the same manner as the FX Series printer incorporating a Slave CPU 8042.

- (1) Turn off the power switches of both the printer and the host computer.

**NOTE:**

Power should always be turned off when inserting or removing the interface board. Removal or insertion of the interface board with the power turned on could cause permanent damage to the board itself, as well as to the printer and the host computer.

- (2) Pull and remove the manual paper feed knob.
- (3) Remove the four screws shown in Fig. 2.
- (4) Lift the upper case of the printer, unplug the cable connector connecting the control panel and the control circuit board from the control circuit board. (See Fig. 3.)
- (5) Remove the upper case and the shield cover. After the upper case has been removed, four poles are visible at the inner rear left of the printer. (See Fig. 4.)

- (6) Remove the three screws securing the SUMI Board as shown in Fig. 9 and unplug the connector of SUMI Board into the mating connector (CN3) of the control circuit board.

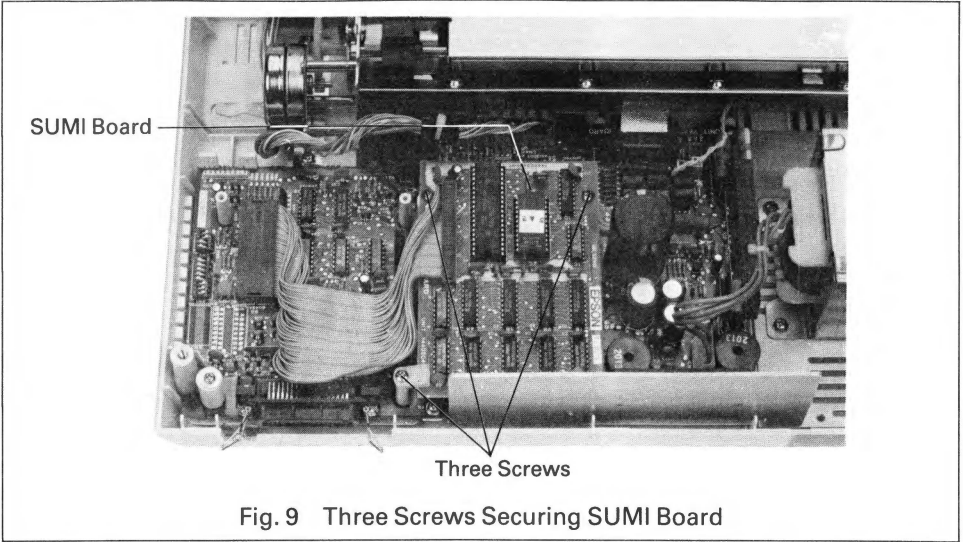

- (7) Loosen the screw set in the FG (frame ground) pattern.

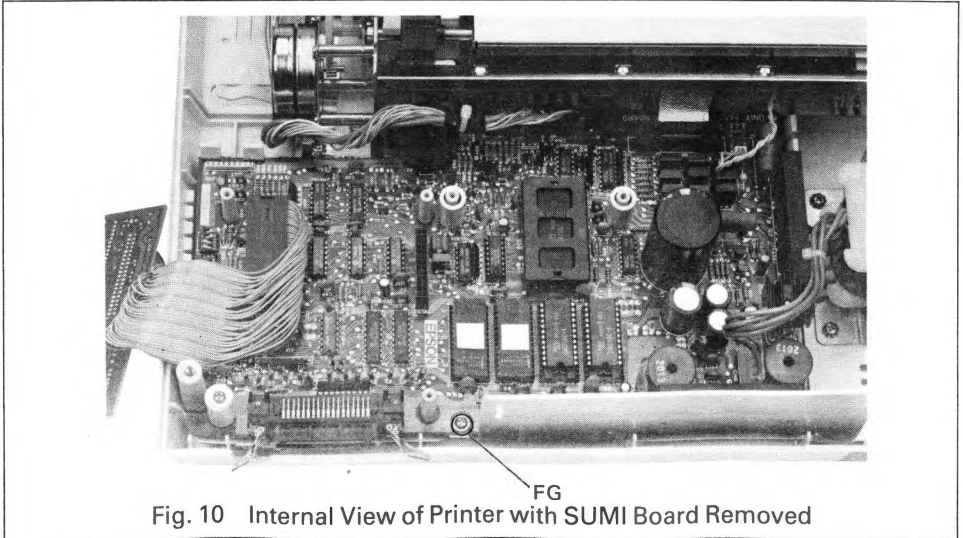



- (8) Connect one end of the frame ground wire (Round Chip) contained in the shipping package of this interface as an accessory to the frame ground terminal. (See Fig. 11.)

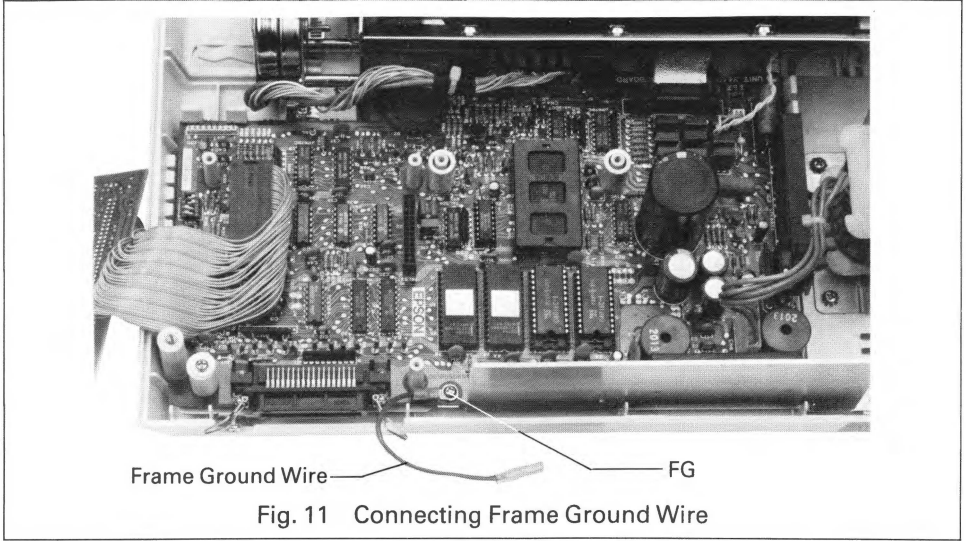

- (9) Remount the SUMI Board. (See Fig. 12.)

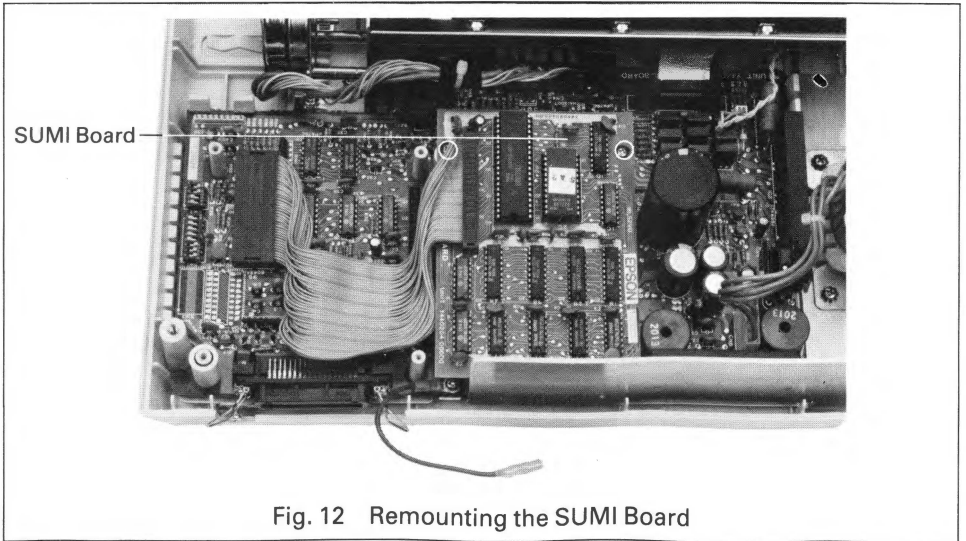

- (10) Plug the connector of the Intelligent Serial Interface Board (Cat. No. 8148) into the mating connector (CN2) on the control circuit board of the printer.
- (11) Secure the serial I/F board on the four poles with the four mounting screws. (See Fig. 13.)

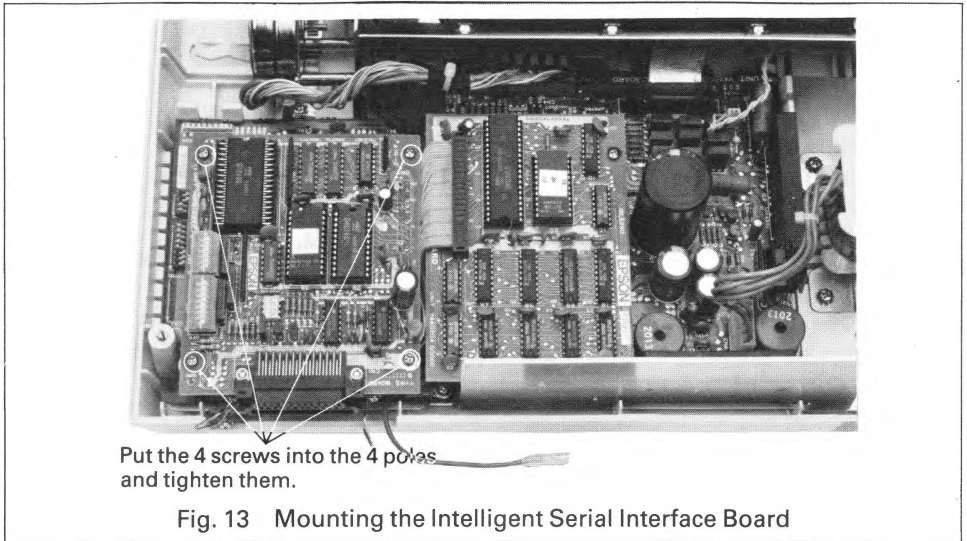

- (12) Connect the Frame Ground wire (FASTON chip) to the FG terminal (FASTON tab) of the Interface Board (Cat. No. 8148). (See Fig. 14.)

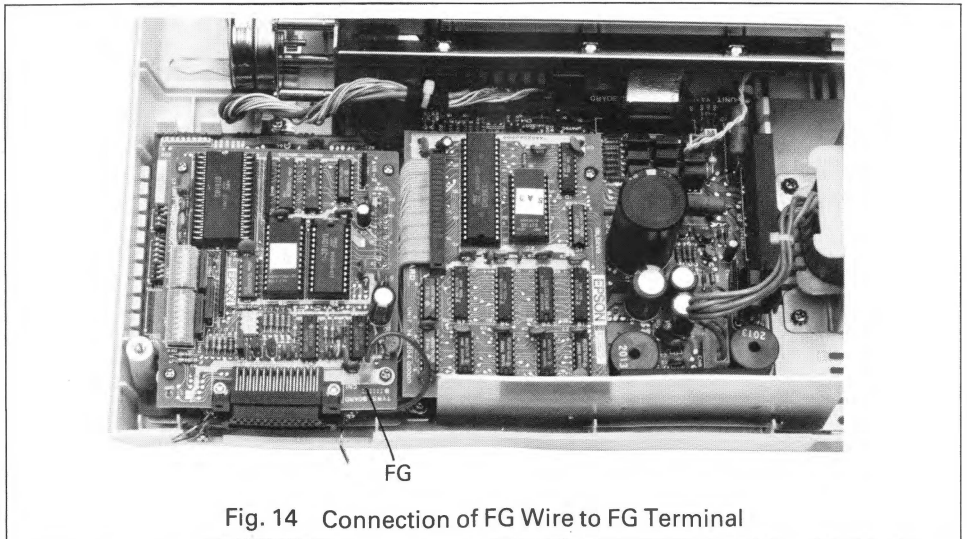

- (13) Replace the upper case.

## 2. Installing the Interface Board in RX Series Printer

To install the Intelligent Serial Interface Board (Cat. No.8148) in the RX Series printer, observe the following procedure.

- (1) Turn off the power switches of both the printer and the host computer.

### NOTE:

Power should always be turned off when inserting or removing the interface board. Removal or insertion of the interface board with the power turned on could cause permanent damage to the board itself, as well as to the printer and the host computer.

- (2) Take off the upper case of the printer as follows. (Refer to the operation manual of the RX series printer for details.)

- 1) Remove the two screws securing the upper case shown in Fig. 15.
- 2) Pull and remove the manual paper feed knob and the connector at the front right corner of the upper case.

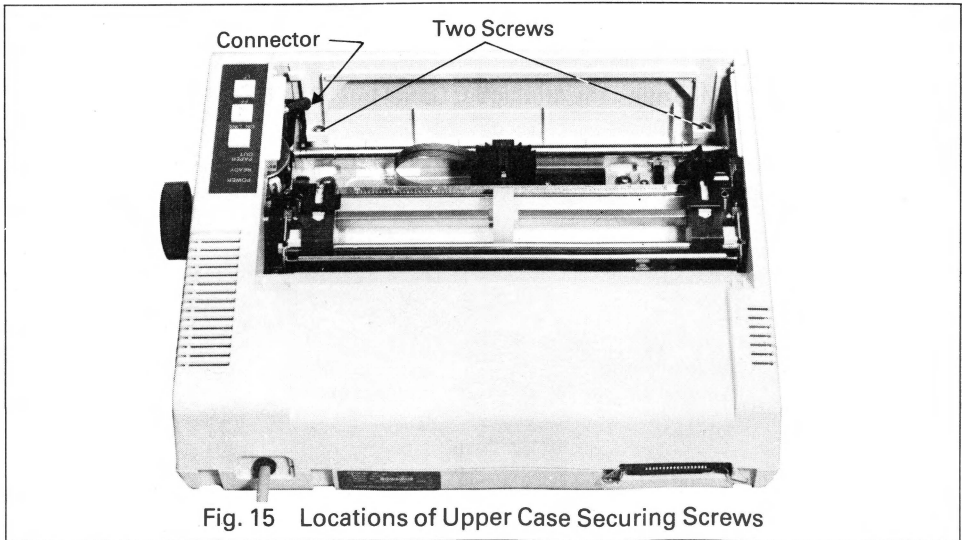

Fig. 15 Locations of Upper Case Securing Screws

- 3) Take off the upper case and the shield cover. (See Fig. 16.)

### NOTE:

The rear of the upper case (where the parallel interface connector is located) is secured with hooks instead of using screws. Therefore, the upper case may be removed easily by lifting the case from its front. After the removal of the upper case, 3 poles are visible at the inner rear center of the printer.

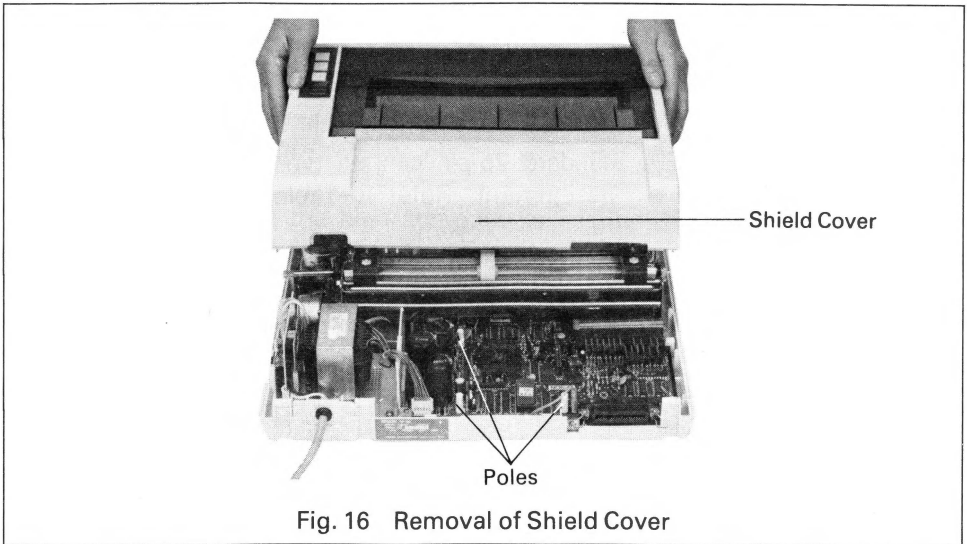

Fig. 16 Removal of Shield Cover

- (3) Plug the connector of the Intelligent Serial Interface Board (Cat. No.8148) into the mating connector (CN3) on the control circuit board of the printer as shown in Fig. 17.
- (4) Secure the serial I/F board on the 3 poles with 3 mounting screws. (See Fig. 17.)

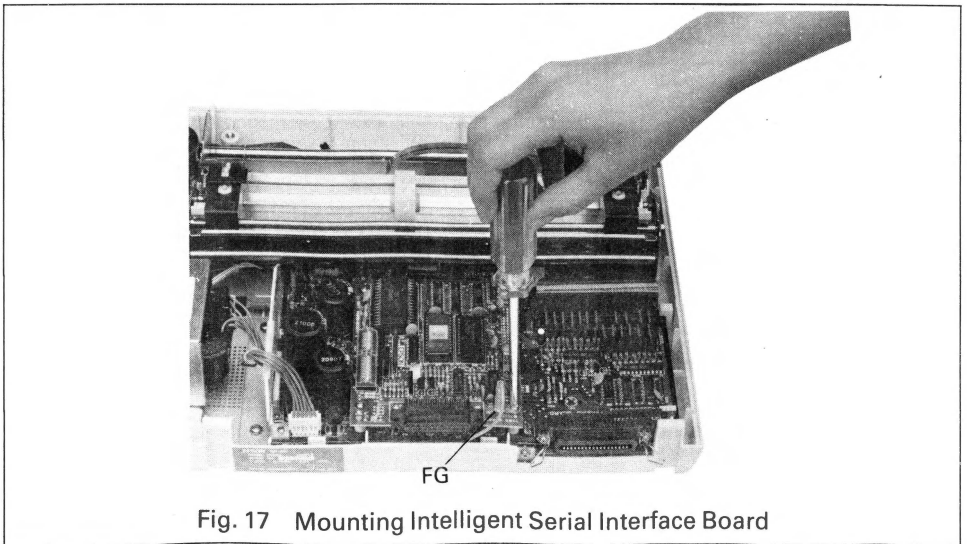

Fig. 17 Mounting Intelligent Serial Interface Board

- (5) Disconnect the Frame ground wire from the control circuit board and connect it to the FG terminal of the I/F board.
- (6) Replace the upper case.

# HARDWARE DESCRIPTION

## 1. Connector and Signals

- (1) I/F board connector: EIA Standard 25-pin cannon type
- (2) Signal description and pin assignment: Refer to Table 6 below.

Table 6 Signal Description and Pin Assignment of I/F Board Connector

Pin No.	Signal Name	Direction	Description
1	Protective Ground	—	Chassis ground
2	Transmitted Data (TXD)	Out	Transmitted serial data
3	Received Data (RXD)	In	Received serial data
6	Data Set Ready (DSR)	In	This signal must be at the positive EIA level for the printer to receive data.
7	Signal Ground	In	Return path for data and control signals.
8	Data Carrier Detect (DCD)	In	This is the same signal as DSR at pin No. 6. DCD and DSR can be held at "SPACE" internally. The signal polarity is factory- set to "SPACE".
11	Reverse Channel (=2nd RTS)	Out	This signal is at the positive EIA level when the printer is ready to accept data entry, and at the negative EIA level when the printer is not ready to accept data entry. Operator can invert the polarity of this signal by the DIP switch pin No. 1-4.
20	Data Terminal Ready (DTR)	Out	
17	TTY-TXD	Out	Low impedance ("MARK") between pin Nos.17 and 24 or X-ON signal sent across pin Nos. 17 and 24 indicates that the printer is ready to accept data; High impedance ("SPACE") or X-OFF signal being sent indicates that the printer is busy. Operator can invert the polarity of this by the DIP switch pin No. 1-4.
24	TTY-TXD Return	—	
25	TTY-RXD	In	Input data of serial current loop.
23	TTY-RXD Return	—	

### NOTES:

1. "Direction" refers to the direction of signal flow as viewed from the printer.
2. All signals except TTY-TXD and TTY-RXD are based on EIA RS-232C level.

## 2. Data Entry

The interface can accept data from a host computer when either the DCD or DSR terminal at the interface connector is in the SPACE state. In other words, this interface operates the same as UARTs (Universal Asynchronous Receiver/Transmitters) such as  $\mu$ PD8251A, etc.

The data received from the host computer is sequentially transferred from the interface to the printer without being processed. Therefore, before the printer is selected or deselected by DC1 or DC3, the DIP switch built into the printer for SLCT IN signal selection must be set to the "OFF" position. (Control codes DC1 and DC3 are applicable only to the FX Series printer.) If an error (parity, overrun or framing) exists in the data transmitted, an asterisk (\*) will be printed in place of the character in error.

### 2.1 Explanation of data entry

This I/F board is equipped with a buffer. However, if the buffer becomes full, data sent cannot be entered and will be discarded.

Also, if DIP SW pin 2-2 is OFF to disable the buffer operation, new data cannot be sent until the data already sent to the printer has been entered. In other words, when the printer is busy, the I/F cannot accept data. Therefore, so-called "free run" of serial data by the host computer should be strictly prohibited.

This I/F board is provided with Reverse Channel and X-ON/X-OFF protocol which is sent from TXD as status flag data to prohibit data entry. The host computer must sense this flag data before attempting data entry. (There are some systems in which it is possible to block serial data transmission by connecting Reverse Channel to the CTS or DSR control lines of the host computer.)

The following is a description of the methods to enable and disable data entry when the buffer operation is disabled and when it is enabled.

### **2.1.1 When buffer operation is disabled**

In this case, X-ON/X-OFF protocol is not performed and the only control performed is by a flag.

This flag is output from Reverse Channel (pin No.11) in the case of the RS-232C and from TTY-TXD (pin No. 17) in the case of the current loop.

If DIP SW pin 1-4 is OFF when a single serial data is received from the host computer, the flag will be set. For the RS-232C, this means that Reverse Channel will become MARK state (negative potential) and for the current loop, that TTY-TXD will enter the SPACE state (high impedance). In this way, further data entry will be disabled.

When this serial data has been entered by the printer, the Interface will reset the flag (with the state of each signal reversed from the state when the flag is set) and data entry will be permitted.

### **2.1.2 When buffer operation is enabled**

When the buffer is enabled, control by both the flag and X-ON/X-OFF protocol will be performed.

#### **(1) Control by Flag Set and Reset**

The maximum capacity of the buffer is 2K bytes. When the rate at which the data is being received is greater than that with which it is printed, the buffer will gradually become full. When the vacant area for bytes in the print buffer becomes 16 bytes, the I/F sets the status flag. The signal levels when the status flag is set is the same as described in 2.1.1 above. Then, data will be received up to the maximum capacity of the buffer but after that no data entry will be accepted. After the flag has been set and data entry prohibited, the operation of the printer will gradually increase the vacant area for bytes in the buffer. When the vacant area reaches a preset value, the flag will be reset and data entry will be enabled.

Flag set and reset timings (Reverse Channel control sequence) are shown in Fig. 18.

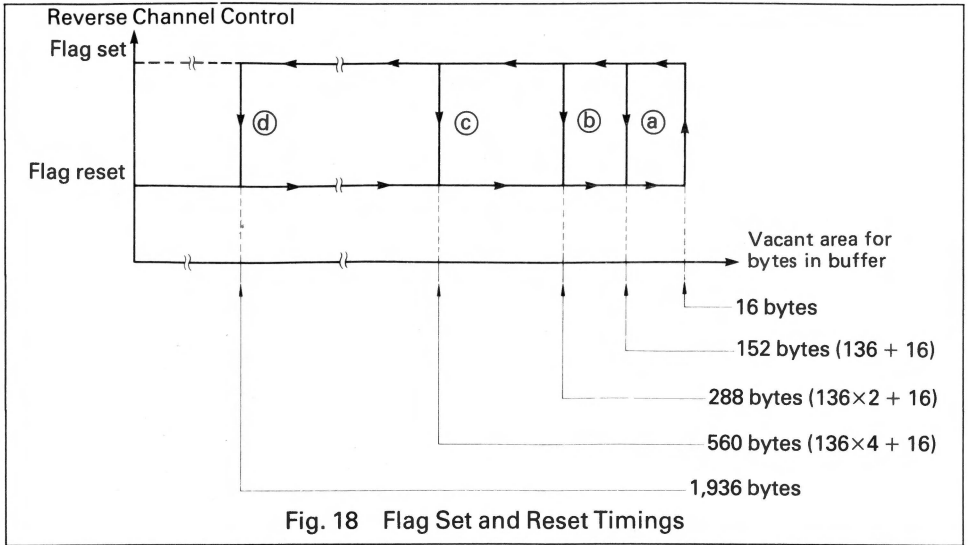

Fig. 18 Flag Set and Reset Timings

**NOTE:**

REVERSE CHANNEL and DTR (pin Nos. 11 and 20 in the pin assignment for interface signals) must be exactly the same signals.

- 1) As shown in Fig. 18 above, the flag is set to block further data entry to the Interface when the vacant area for bytes (characters) in the buffer becomes 16 bytes. Data entry is possible until the vacant area for bytes in the buffer becomes zero.
- 2) As the printer continues processing after the next data entry is blocked, the vacant area in the buffer memory increases.  
The flag is reset at one of the following four timings predetermined by the DIP switch setting. (See Table 4.)

**Vacant Area in Buffer (Bytes)**

- (a) 152
- (b) 288
- (c) 560
- (d) 1,936



(2) Control by X-ON/X-OFF protocol

Data entry is performed with the same timing as Reverse Channel Sequence. Handshaking is performed with two types of words (X-ON and X-OFF) sent from the printer according to the preset conditions (bit rate, parity, word length, etc.). In other words, X-ON <11><sub>H</sub> denotes that data entry is enabled, while X-OFF <13><sub>H</sub> denotes that data entry is disabled.

1) Transmit timing of X-OFF signal

The X-OFF signal is transmitted when the vacant area for bytes in the print buffer is between 8 and 16 bytes. Once the printer enters the X-OFF state (which is equivalent to the flag set state of the Reverse Channel), the X-OFF signal is transmitted repeatedly at certain time intervals corresponding to the selected bit rate. (Refer to Table 7.)

2) Transmit timing of X-ON signal

The X-ON signal is transmitted repeatedly at certain time intervals after the power switch is turned on, or when the entire buffer memory is vacant and has sufficient room to receive data (which is equivalent to the flag reset state of the Reverse Channel). (Refer to Table 7.)

3) Data transfer after transmission of X-OFF signal

When data is received while the remaining capacity of the buffer memory is insufficient after the X-OFF signal is transmitted, normal processing by the printer is not guaranteed and received data is discarded.

**Table 7 Bit Rates and X-ON/X-OFF Transmit Timings**

Bit rate	X-ON/X-OFF
75	1.06 sec.
110	0.72 sec.
134.5	0.59 sec.
150	0.53 sec.
200	0.40 sec.
300	0.26 sec.
600	0.13 sec.
1,200	66.0 msec.
1,800	44.0 msec.
2,400	33.0 msec.
4,800	16.5 msec.
9,600	8.3 msec.
19,200	4.1 msec.

Each of the above transmit timings is 80 times the interval of a 1-bit cell. In other words, with data of 10 bits/character, one X-ON or X-OFF signal is transmitted per 8 characters. The timing of the TXD signal in status transition between X-ON and X-OFF is as shown in Fig. 19.

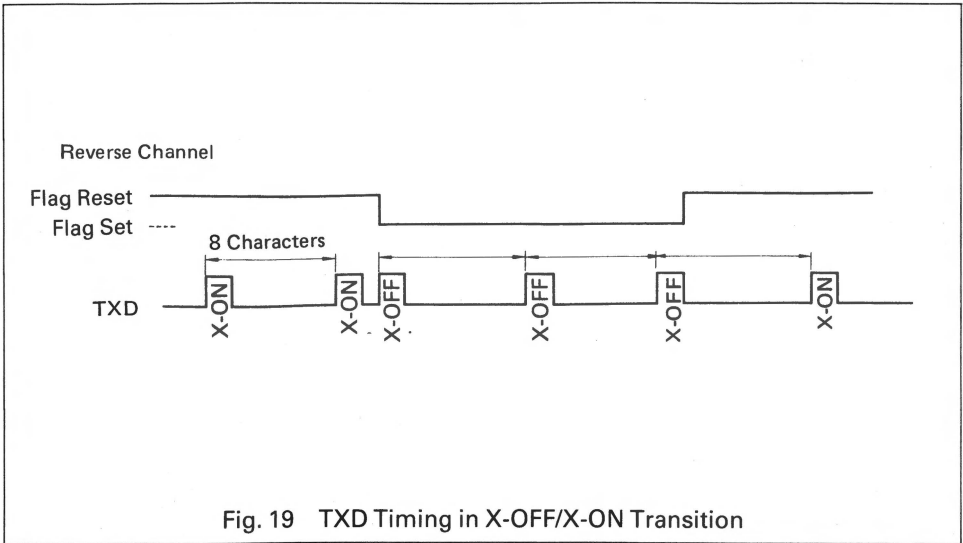

Fig. 19 TXD Timing in X-OFF/X-ON Transition

### 2.1.3 Printer status error

A printer status error (printer I/F signal  $\overline{\text{ERROR}} = \text{"LOW"}$ ) occurs when the printer is in either of the following conditions.

- Paper-out status
- Printer OFF-LINE state

When a printer status error (printer I/F signal  $\overline{\text{ERROR}} = \text{"LOW"}$ ) such as paper-out status occurs, the flag is immediately set regardless of the number of bytes remaining in the buffer memory.

However, this condition does not affect data entry into the buffer memory.

## 2.2 Serial Data Timing Chart

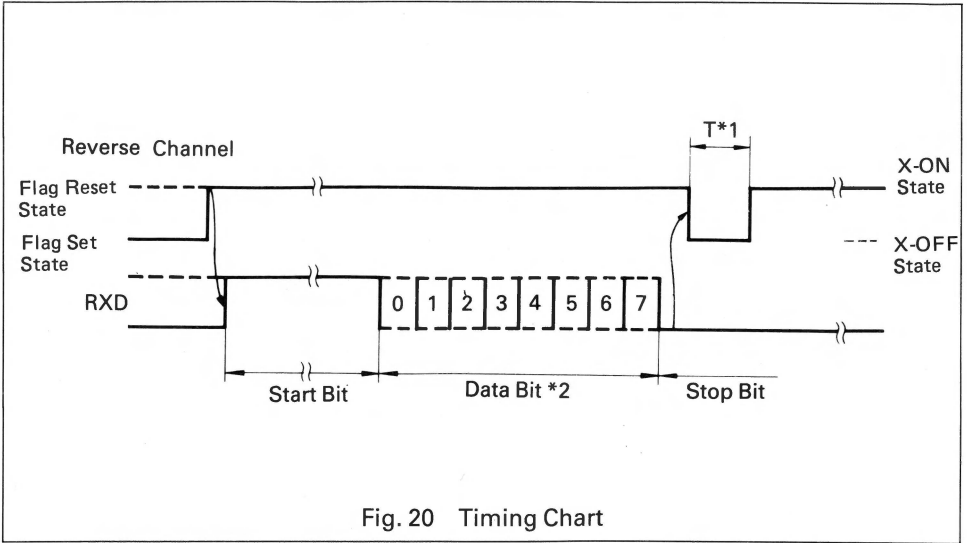

Fig. 20 Timing Chart

- \* 1 The value of "T" varies according to the input data.
- \* 2 The word structure of serial data is:  
1 start bit + 7 or 8 data bits (selectable by operator) + 1 or more stop bit.

### NOTE:

As shown in Fig. 20, Reverse Channel flag set corresponds to the X-OFF state in X-ON/X-OFF protocol and flag reset to the X-ON state. The timing when the X-ON/X-OFF (flag set) signal is sent when the current state is X-OFF (flag reset) is delayed 8 characters compared to the timing of flag reset. (See Fig. 19.) The timing for transition from X-ON to X-OFF is the same as the timing for flag set.

Table 8. Word Structure

Start Bit	Data Bit	Parity Bit	Stop Bit
1	7	No parity	1 or more
1	7	Odd parity	1 or more
1	7	Even parity	1 or more
1	8	No parity	1 or more
1	8	Odd parity	1 or more
1	8	Even parity	1 or more

# SELF-TEST

The self-test of the printer can be performed in the following two modes by setting the pins Nos. 5 and 6 of the DIP switch 2 built in the interface board.

SW2-5	SW2-6	Mode
ON	OFF	Loopback
ON	ON	Line monitor

## 1. Loopback Mode

When the power switch is turned on with the above DIP switch setting, the printer enters Loopback mode. When the power switch is turned on after connecting the pin No. 2 (TXD) and pin No. 3 (RXD) of the interface connector, data in the range of  $<20>_H$  to  $<7E>_H$  are sent from pin No. 2 to pin No. 3 of the interface and received, and printed by the printer. In this case, the interface must be in RS-232C mode. (In the Current Loop mode, this operation cannot be performed.)

### NOTE:

Since Loopback mode is performed in RS-232C mode, Jumper J8B must be connected.

## 2. Line Monitor Mode

In Line Monitor mode, data on the RS-232C line are printed in hexadecimal code. The timing of Buffer Full Recovery is determined by the DIP switch setting. The only difference from the normal processing is that data is printed after it is converted to hexadecimals.

### 3. Recommended Circuits for Connection

(1) Recommended Line Driver and Line Receiver in the case of RS-232C interface.

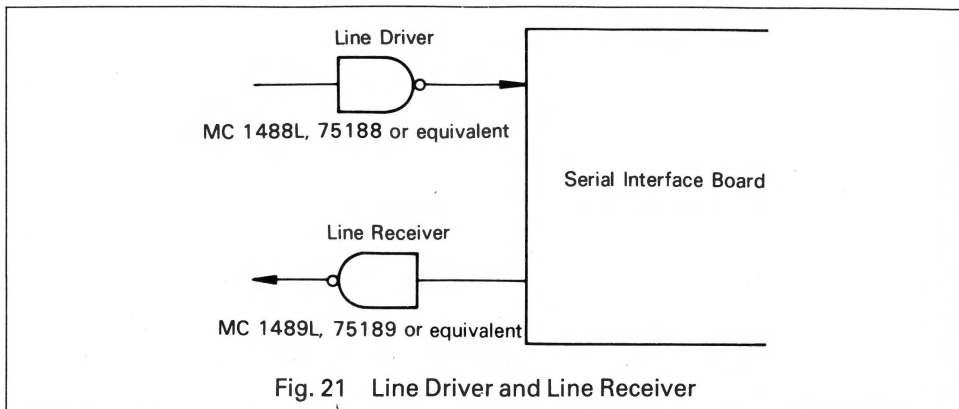

Fig. 21 Line Driver and Line Receiver

(2) Recommended Interface Circuit in the case of Current Loop Interface.

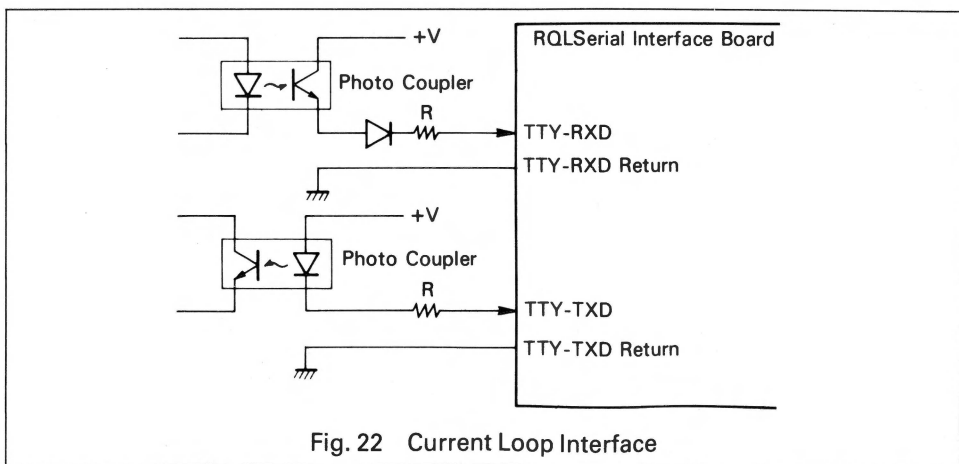

Fig. 22 Current Loop Interface

\*The value of "R" should be selected so that the loop current becomes 10 to 20 mA.

\*"+V" should be 3V to 24V.

#### NOTES:

1. In the case of a serial interface, undefined codes are also ignored.
2. When a parity error occurs, character in which a parity error has been occurred will be ignored.
3. Serial input data should be held at "MARK" in the normal state (the state that characters are not transferred.)

# 4. Parts Locations

Fig. 23 shows the component layout of the Intelligent Serial Interface Board (Cat. No. 8148).

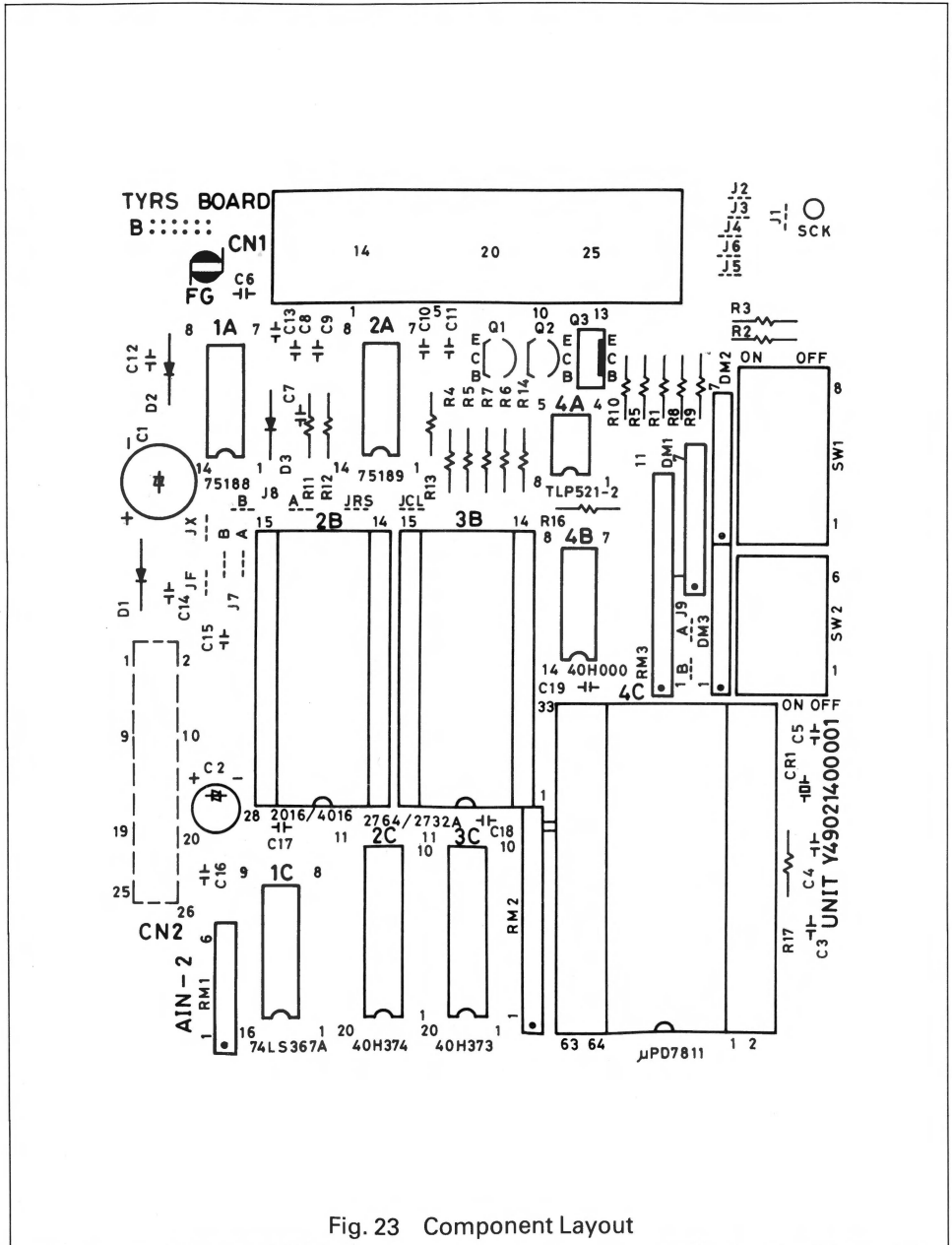

Fig. 23 Component Layout

# PARTS LIST

Part Name	Location No.	Standard
LSI (MPU)	4C	μPD7810
LSI (RAM)	2B	μPD4016
LSI (PROM)	3B	2732A3 (FIF-0)
TTL-IC	1A	75188
TTL-IC	2A	75189
TTL-IC	1C	74LS367A
CMOS-IC	4B	40H000
CMOS-IC	3C	40H373
CMOS-IC	2C	40H374
Photocoupler	4A	TLP521-2
Transistor	Q1, Q2	2SC1815
Transistor	Q3	2SD793
Ceramic Oscillator	CR1	CSA7.37MT
Diode Array	DM1-DM3	μPA54H
Diode	D1	S5277B
Diode	D2, D3	1S2075K
Electrolytic Capacitor	C1	ECE-A1ES331
Electrolytic Capacitor	C2	ECE-A1ES470
Ceramic Capacitor	C3, C12-C19	ECF-F1E1042F
Ceramic Capacitor	C4, C5	ECC-F1H330K
Ceramic Capacitor	C6, C7	ECK-F1H391KB
Ceramic Capacitor	C8-C11	ECK-F1H102KB
Block Resistor	RM1	EXB-P85103K
Block Resistor	RM2, RM3	EXB-P810103
Carbon Resistor	R1, R2, R3	ERD-S1TJ471
Carbon Resistor	R4-R6, R14	ERD-25PJ122
Carbon Resistor	R7	ERD-25PT332
Carbon Resistor	R8, R9	ERD-25PJ472
Carbon Resistor	R10, R16, R17	ERD-25PJ103
Carbon Resistor	R11-R13	ERD-25PJ393
Carbon Resistor	R15	ERD-25PJ471
DIP Switch	SW1	DIP-A8
DIP Switch	SW2	DIP-A6
IC Socket	2B, 3B	DILB-28P-8J
IC Socket	4C	C5W6411
IC Socket Cover	2B, 3B	DILBC-28
Connector	CN1	GMM-25FDA
Connector	CN2	HKP-26MS-3B
FASTON Tab Terminal	FG	61134-1
Check Terminal	SCK	NO246 Contact

# Schematic Diagram

Fig. 24 shows the schematic diagram of the Intelligent Serial Interface Board (Cat. No. 8148).

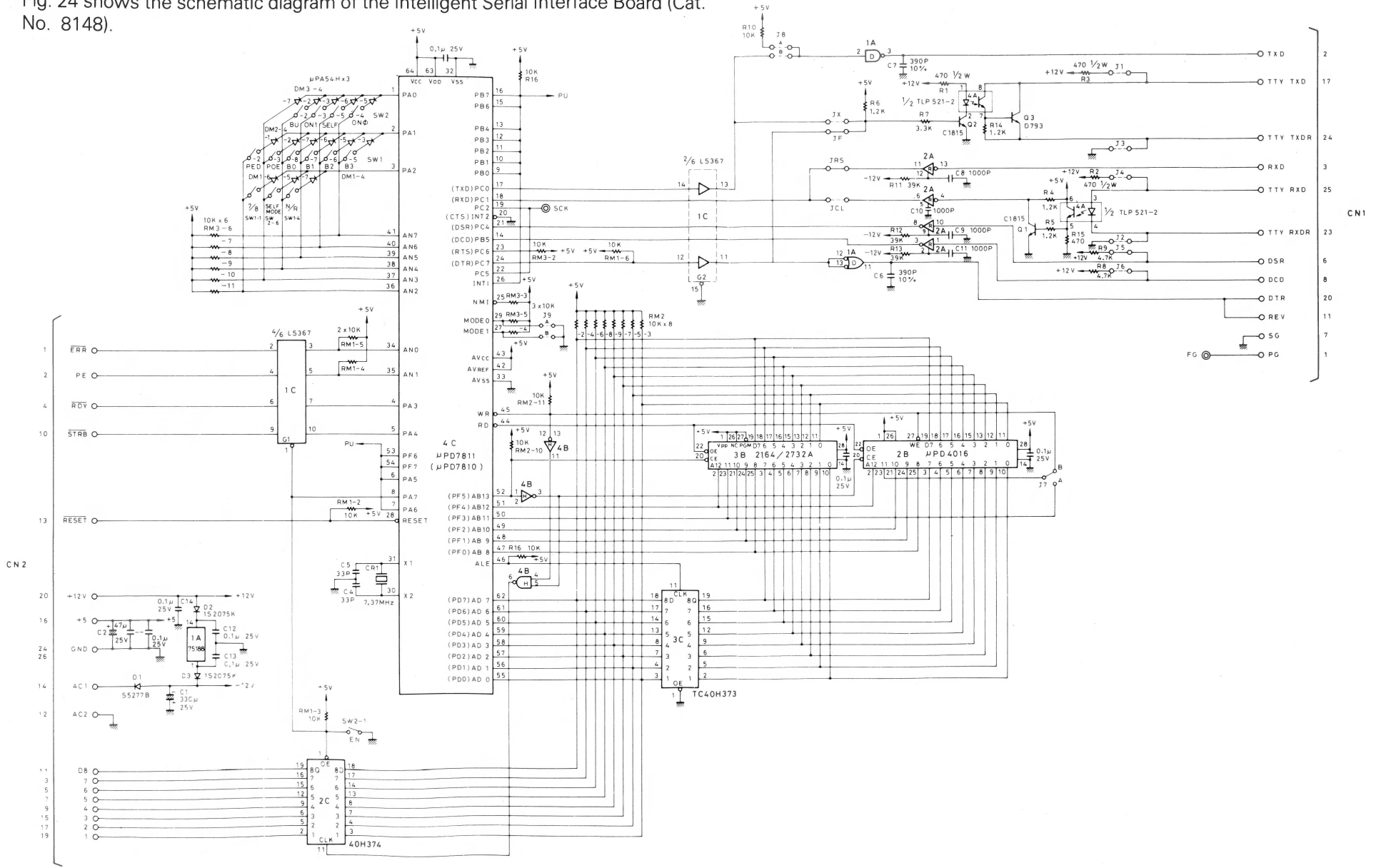

Fig. 24 Schematic Diagram of Intelligent Serial Interface Board



# EPSON

EPSON CORPORATION

## EPSON OVERSEAS MARKETING LOCATIONS

---

### EPSON AMERICA, INC.

3415 Kashiwa Street  
Torrance, CA 90505 U.S.A.  
Phone: (213) 539-9140  
Telex: 182412

### EPSON UK LTD

Dorland House  
388 High Road,  
Wembley, Middlesex, HA9 6UH, U.K.  
Phone: (01) 900-0466/7/8/9  
Telex: 8814169

---

### EPSON DEUTSCHLAND GmbH

Am Seestern 24  
4000 Düsseldorf 11  
F.R. Germany  
Phone: (0211) 596-1001  
Telex: 8584786

### EPSON ELECTRONICS (SINGAPORE) PTE. LTD.

#09-13/#09-14, World Trade Centre,  
No. 1 Maritime Square, Singapore 0409  
Phone: 2786071/2

---

### EPSON ELECTRONICS TRADING LTD.

Room 411, Tsimshatsui Centre,  
East Wing 6, Ching Yee Road  
Tsimshatsui Kowloon, Hong Kong  
Phone: 3-694343/4  
3-7213427  
3-7214331/3  
Telex: 64714

### EPSON ELECTRONICS TRADING LTD. TAIWAN BRANCH

1, 81F K.Y. Wealthy Bldg. 206, Nanking  
E. Road, Sec. 2, Taipei, Taiwan, R.O.C.  
Phone: 536-4339  
536-3567