

QUADLINK™  
BY QUADRAM™

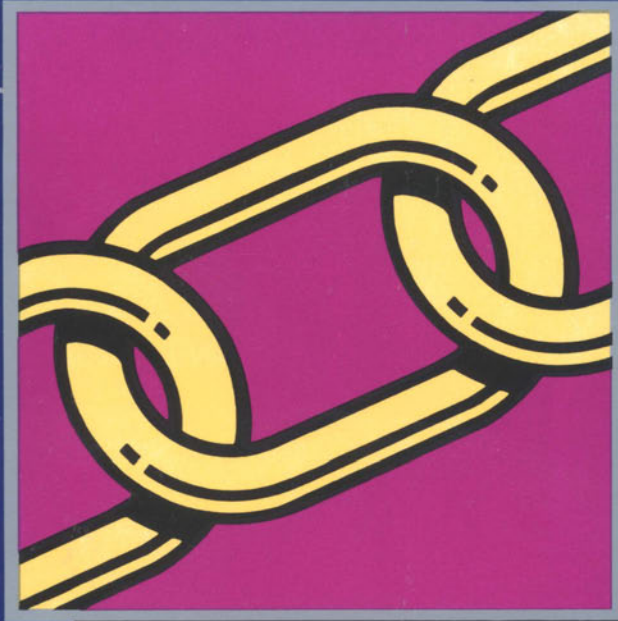

QUADRAM  
CORPORATION  
An Intelligent Systems Company



QUADLINK™  
BY QUADRAM™

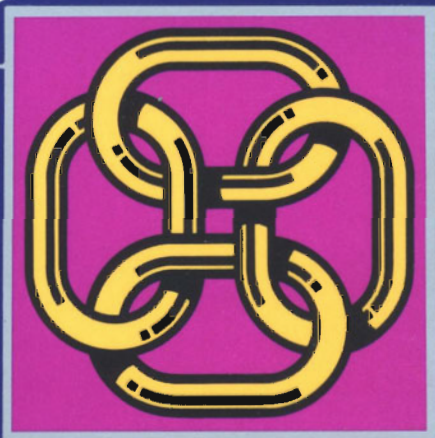

QUADRAM  
CORPORATION  
An Intelligent Systems Company



## **Quadlink User's Guide Documentation to Quadram's Quadlink**

This board has been designed to be compatible with the IBM Personal Computer, along with any Quadram enhancement board installed in the above. The Quadlink may not be compatible with any other brand of expansion board and Quadram accepts no responsibility for the use of Quadlink with such boards.

NOTE: Before attempting to install Quadram's Quadlink, read this manual thoroughly. If you have any trouble getting the Quadlink to work, or if for any reason this product should require factory servicing or repair, contact Quadram's technical support specialists at 404-923-6666. You will receive complete return instructions plus a return authorization (RA) number.



**4355 International Blvd. / Norcross, Ga. 30093 / (404) 923-6666  
TWX 810-766-4915 (QUADRAM NCRS)**

©1983 by Quadram Corporation  
All Rights Reserved

Quadlink User's Guide 8/30/83JRP/QL-3,000

3rd Edition Printing: September 1983

PART NO. 9510

## **WARRANTY LIMITATIONS**

All warranties for this product expressed or implied, including merchantability and fitness for a purpose, are limited to a one year duration from date of purchase, and no warranties, expressed or implied, will apply after that period.

If this product does not perform as warranted herein, owner's sole remedy shall be repair or replacement as provided above. In no event will Quadram Corporation be liable to any purchaser for damages, lost revenue, lost wages, lost savings, or any other incidental or consequential damages arising from purchase, use or inability to use this product, even if Quadram has been advised of the possibility of such damages.

## WARRANTY PROVISIONS

The Quadram Corporation warrants this product to be in good working order for a period of one year from the date of purchase as a new product. Should this product fail to perform properly any time within that one year period, Quadram Corporation will, at its option, repair or replace this product at no cost except as set forth in this warranty. Replacement parts or products will be furnished on an exchange basis only. Replaced parts and/or products become the property of Quadram Corporation. No warranty is expressed or implied for products damaged by accident, abuse, misuse, natural or personal disaster, or unauthorized modification.

Warranty service described herein may be obtained by delivering this product, during the one year warranty period, to any authorized Quadram Dealer or to Quadram's Factory Service Center located at 4355 International Blvd., Norcross, Georgia, 30093. Whether delivering to a Dealer or to the Factory, product must be accompanied by proof of purchase date. If shipped by U.S. Mail or any common carrier, owner agrees to insure and accept all liability for loss or damage to this product, to prepay all shipping charges, and to use shipping container equivalent to original packaging.

---

Periodic updates or changes to this material will be made in new editions of this publication.

Requests for dealer information, comments or other inquiries may be addressed to: Quadram Corporation, 4355 International Blvd., Norcross, Georgia 30093. Quadram Corporation has no obligation to return or hold confidential any material or information you supply unless arrangements are made pursuant to Quadram's receipt of said information.

---

## TABLE OF CONTENTS

## SECTION

<b>Foreword</b> .....	<b>A</b>
A Sea of Apple Software	A2
A New Kind of Personal Computer	A3
Using This Manual	A5
<b>Introduction</b> .....	<b>B</b>
Unpackaging the Quadlink; the hardware; the software; and the user's guide	
Unpackaging the Quadlink	B2
Taking A Closer Look	B5
The Hardware	B5
The Documentation	B8
The Software	B9
The Software Disks	B11
Copying Quadlink Software	B12
<b>Installation</b> .....	<b>C</b>
Attaching the cables to the board; opening the PC; inserting and cabling the Quadlink; the System Master disk	
Getting the Quadlink Ready	C1
Opening the PC	C3
The PC's Expansion Slots	C5
The Disk Controller Cable Connection	C7
Routing the Speaker Wire	C8

Connecting the Game Paddles	C9
Sliding Quadlink into the Slot	C10
The Disk Controller Connection	C11
The Video Display Connection	C12
Putting the PC Back Together	C14

**Operation ..... D**

Booting the Quadlink; using the keyboard; using the video screen modes; standard keyboard commands; using I/O devices; Quadlink access commands; other operational differences

The Quadlink Mode	D3
The Keyboard	D3
The Standard Keypad	D4
The Caps Lock Key	D4
Use of Lower-case Letters	D4
The Escape Key	D5
Moving the Cursor Right	D5
And Moving the Cursor Left	D5
And Down	D6
And Up	D6
Clear to the End of the Line	D7
Clear to the End of the Screen	D7
Or the Beginning of the Screen	D7
The Control Key	D7
CTRL-ALT-DEL	D8
CTRL-BREAK	D8
CTRL-ALT-A	D8
FP	D9
INT	D9
F10	D10



The F Keys in Quadlink Mode	D10
The Numeric Keypad	D12
Num Lock	D13
The Screen	D13
The Standard Text Mode	D14
Low-Resolution Graphics Mode	D15
High-Resolution Graphics Mode	D17
Using Shared I/O Devices	D20
IN#0	D21
IN#2	D21
IN#6	D22
Changing the Output Source	D22
PR#1	D22
PR#2	D22
PR#6	D23
PR# And IN# Command Limitations	D23
Using Other PC Expansion Cards	D23
The Quadlink Serial Port and Uses	D24
Getting Down to BASIC	D32
BASICA VRS Floating Point BASIC	D33

**DOS** ..... **E**

What DOS is; What a floppy disk is; DOS commands; DOS functions; Error messages; DOS binary commands; using BASIC with Quadlink

Using DOS	E2
The Disk Drive	E6

Booting DOS	E7
Initializing A New Disk	E8
DOS commands	E11
SAVE	E11
LOAD	E13
Naming Files	E14
CATALOG	E16
DELETE	E17
RENAME	E17
Working With More Than One Drive	E18
Syntax	E19
File Name	E19
Drive Number	E20
Volume Number	E20
Using the DOS Syntax	E21
LOCK	E22
VERIFY	E23
A Turnkey System	E24
Using the I/O Devices	E26
DOS Error Messages	E27
Machine Language Commands	E31
BLOAD	E32
BRUN	E33
BSAVE	E33
A Quick Review	E33
The Filer Disk Utilities	E34
Filer Instructions	E35
Set Slot and Drive	E35
Catalog	E36
Copy Disk	E36
Copy DOS	E37
Change Booting Program	E37
File Options	E38
Lock Files	E39
Unlock Files	E39
Delete Files	E39

Copy Files	E40
Fast Copy Instructions	E41
Disk Test and Disk Speed	E43
How To Use Disk Test	E48
Swapping IBM and Apple Files	E49

**Problems ..... F**

Problems you may encounter and how to solve them; example of a typical work session

Working Through Problems	F1
Video Difficulties	F2
Problems Using DOS	F4
Audio Difficulty	F5
Input/Output Problems	F5
Sample Work Session	F6
Afterword	F10

## **Specifications**

### **Software**

A list of available software compatible with Quadlink

### **Literature**

References for further reading

### **Glossary**

*Apple and the Apple logo are registered trademarks of Apple Computer, Inc.*

*IBM and the IBM logo are registered trademarks of International Business Machines Corporation.*

*Apple DOS 3.3 is a registered trademark of Apple Computer, Inc.*

*Applewriter is a registered trademark of Apple Computer, Inc.*

*Space Raiders is a registered trademark of United Software of America.*

## FOREWORD

Quadram's Quadlink is a new innovative plug-in expansion card for your IBM Personal Computer. It is the first card of its kind that does more than enhance the operation of your computer. Quadlink practically doubles the power of your PC by opening it to a whole new world of application software and programming abilities. This new world is made up of all the thousands of available software packages written for the popular Apple and Apple-compatible computers, software previously off-limits to PC owners.

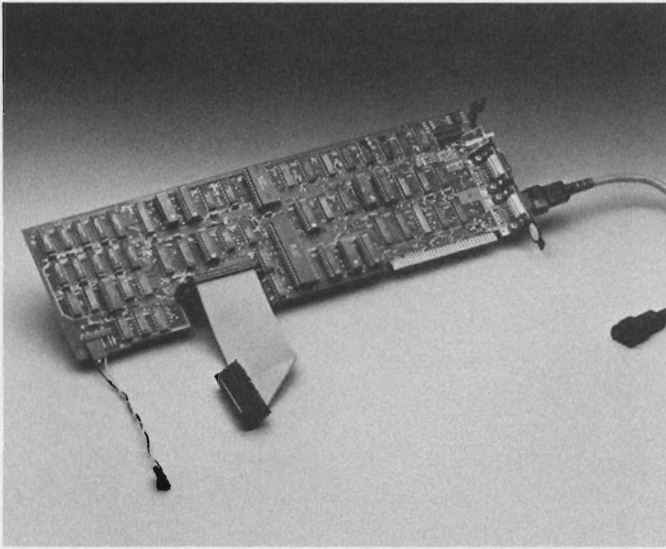

*Quadram's Quadlink*

Due to specific built-in differences between the two, IBM PCs and the Apple computers are unable to share software or programming information until the programs and information have been "restructured" in a particular way. This restructuring conforms the information to the "execution environment" of the different computers, the manner in which the computers process information. This is the reason an Apple software disk won't work in a PC, why an IBM disk won't work with an Apple II. The execution environments of the two are very different.

Consequently, software written for any of the popular computers available today is designed specifically for the execution environment of that computer. The programs contain specific language instruction codes which allow a computer's processor to interpret the program data. This set of instruction codes is the key to the heart of the computer, the password to the execution environment of the unit.

## **A SEA OF APPLE SOFTWARE**

But why is it important to be able to (in effect) "share execution environments"? What makes the Quadlink so valuable?

Such questions are best answered when the state of the art is viewed from a current standpoint. The Apple computers and most Apple-compatible computers are the grandfathers of the personal computer revolution. They have been around for a relatively long time: 6 or 7 years. During this time personal computers were slowly but unrelentingly becoming accepted as a common and valuable new type of information processor.

At this same time, software support companies began sprouting up, providing the necessary software packages to run on the new home and office computers. Since the Apple-types were by far the most prevalent personal computer available the software being generated was geared to the common execution environments of these types. Soon there were thousands of commercial packages ready for these computers; anything from entertainment to business to educational packages were now available.

Then, at the seeming height of this new craze, IBM introduced its Personal Computer.

## **A NEW KIND OF PERSONAL COMPUTER**

The IBM PC, as it is affectionately called, immediately began to attract a lot of attention, both from the home and business sectors. But, on close examination, one problem cropped up and it was this: though the PC was unquestionably a great computing machine there was not a lot of prepackaged software out there for it to compute. Sure, the standard packages were available, but when this list was compiled and put next to a list of software for a popular computer like the Apple, the PC list seemed undeniably tiny. This was because the PC was a new kind of computer. And most all the prepackaged software was written for the other computers.

So computer buyers had to face the uncomfortable dilemma: to buy a great hardware system and wait for the software to eventually appear or buy an okay hardware system and have a seemingly unending supply of software ready to use.

A tough decision to make. And what's more, once they had chosen a system their search for new software was always bound to one restriction: the software you choose must be software written for your kind of system.

So like a matchmaker arranging a couple's first meeting, the software buyer was constantly scrutinizing the system he owned against the software package he desired with one question always in mind, "Are they compatible?"

Now Quadlink enters the market and the best of both worlds is available to you. The best system can now use the best software.

You may think of Quadlink as an enhancement board for your IBM PC. But it is much more than this. In essence, what the Quadlink does is let you run most software programs written for the Apple II and II plus computers on your PC. Since more software packages have been written for the Apple than any other personal computer, this increases your PC's software capabilities a hundred fold. A whole new world of entertainment, educational, and business software is now ready for any application you have in mind.

Quadlink helps you get the most out of your IBM Personal Computer by letting it do more for you than ever before.



## USING THIS MANUAL

Because the Quadlink is such an innovative device for your PC, you must first learn how to use it properly before it can begin to help you. This book was written with this purpose in mind.

Actually, in computer jargon, this book is called the documentation. The word documentation is simply a fancy name used by computer-niks for an instruction manual, user's manual, operations manual -- or anything like that. The documentation simply documents what the piece of equipment is supposed to do.

You are reading the documentation right now. But we'll call it a user's guide, because basically that is what it really is: a guide to help you get the most out of your Quadlink.

Generally speaking, there are two kinds of people who will be using the Quadlink. Consequently, there are two kinds of people who will be reading this guide.

The first kind is the person who is fairly experienced in the ways of computers, a person who understands how computers work, how they process and use information.

If you are this kind of person, you will probably not want to read this entire guide. You may only want to read the parts that provide you with the specific information needed to get your Quadlink up and running in your system. Of course, reading the whole thing isn't such a bad idea, either. Every page contains some bit of information that just might prove very useful to you in one way or another.

The second kind of person who will be reading this guide is the beginner, the newcomer to the field of computers and all the jargon applied to them.

If you are this kind of person, you should read this entire guide. Front to back. Its contents will help you understand how to properly set up the Quadlink in your system and make it work for you. Once you have turned the last page, you'll be able to tackle new computing tasks like an old pro.

"Why, that was really easy!" you'll say when you're done.

And you'll be right.

## INTRODUCTION

The big thing that the Quadlink will be used for is obvious. With it, you can run Apple-compatible software on your IBM Personal Computer. And that's really a big thing. In fact, that's what most people will use the Quadlink for: to intermittently turn their PC into a computer that can run Apple software.

But there's a lot more that the Quadlink can be used for, many other different ways it can help you.

The beginning computer user need not concern himself with these less obvious uses. For him, just being able to choose from the thousands of business, entertainment, and educational software packages he likes will be more than enough to keep him busy and content.

But, if you've had some computer experience and have an itch to use Quadlink to its fullest potential, its possible applications become numerous and diverse.

For instance, you can use Quadlink

- as a means of sharing data files in a home or office environment, when two different kinds of computers --IBM and anything Apple-compatible -- are used to do related work. With Quadlink, the disks become compatible.
- to convert text files containing the Apple 3.3 Disk Operating Systems to IBM compatible formats.

- to produce very high speed graphics.
- as a means for coprocessing information. In other words, you can perform the execution of two programs at full speed at the same time in your computer as long as the Quadlink's operation does not require the use of an I/O device.
- as a way to test software written for the IBM PC- or Apple-compatible systems.

That's a lot of extra things the Quadlink lets your PC system do. After you've worked with the Quadlink a bit, you may even think of a few more possible applications we haven't touched on in the brief list above. But for now, let's take things a little slower. Let's spend a little time getting to know what the Quadlink is, how it works in the Personal Computer, and how it does all the wonderful things we've talked about.

## UNPACKAGING THE QUADLINK

Once you bring the Quadlink package home from the store, the first thing you will want to do is open it to make sure everything is there.

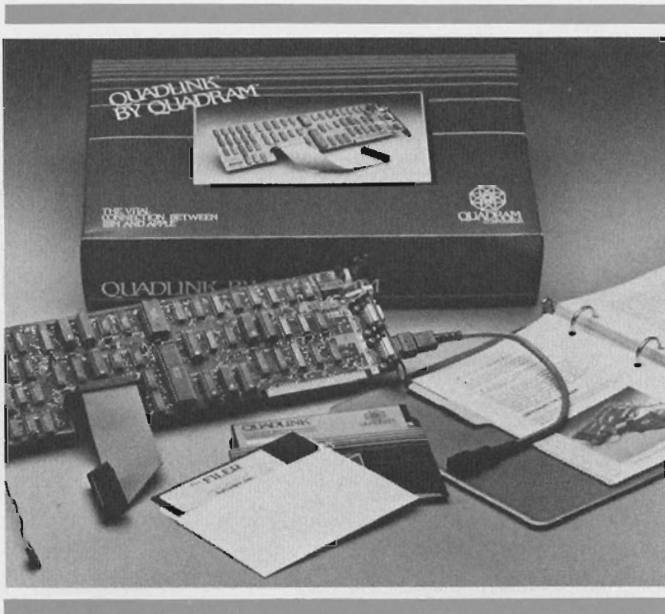

*The Quadlink package: hardware, software, and user's guide*

The Quadlink actually comes to you in one package containing three separate pieces. The first piece you'll uncover is the printed circuit board, the actual Quadlink. When you take this out of the package, you'll be able to lift up the inner flap and see the next two pieces. The first is a small blue box containing all the cables needed to integrate the Quadlink into your PC system. The second box -- the squarish silver and blue one-- contains the USER'S GUIDE and the floppy disks housing the software provided with the Quadlink.

Since you are reading these words right now, we can safely assume that the user's guide was not left out of the package. The floppy disks accompanying the Quadlink can be found in the back of this guide. They are located in a clear plastic slip case.

Each of the programs on these disks performs special operations which help you use the Quadlink in your system. So, before going any further, check to see that the disks are present. We'll wait for you right here.

Find them okay? Good.

If the disks are not present, your package is incomplete. But don't worry. Simply contact the store where you bought the Quadlink and your computer retailer will be happy to provide you with whatever you are missing.

The same is true if you discover anything else missing.

As mentioned above, the package contains the actual Quadlink: the printed circuit board and all the needed cables. You'll probably notice right away whether or not the board is in the box. It's pretty hard to overlook this. But all the cables which must accompany the board might be easy to pass over. The first cable is a flat connector cable to join the Quadlink to the disk controller card in the PC. The second cable is six inches long with a male 9 pin sub-mini D connector located at each end. This cable is used to connect the Quadlink to the PC's video display card. And finally there is a yellow and black wire used to connect the Quadlink to the PC system speaker.

If for some unknown reason you open the box to a layer of foam rubber and air, contact your computer dealer immediately.

Usually, though, you will find everything is there, right where you'd expect it.

## TAKING A CLOSER LOOK

Once our inspection of the package is complete, we can look a little more closely at what the Quadlink is, what it's supposed to do, and how it's supposed to do it in your IBM PC.

Let's begin by separating the package into its three logical parts: the hardware, the software, and the documentation.

## THE HARDWARE

The hardware -- as you have probably already guessed -- is any physical part of the Quadlink package that performs an operational function (ICs, traces, connectors, etc.) in the computer. The manual you are reading now cannot be called hardware because, even though you can touch it, it does not play an operational role in the use of the Quadlink.

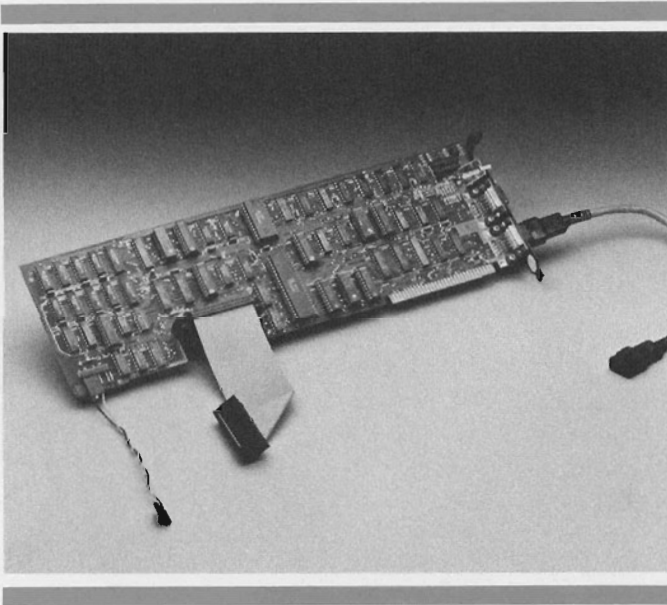

*Quadram's Quadlink*

The hardware, then, consists of the printed circuit board, the flat disk controller cable, the speaker wire and the nine pin sub mini D connector cable. These items are all essential to the function of the Quadlink.

Pick up the printed circuit board now. Pretty light, isn't it? Weighs scarcely a pound. But the Quadlink is a real heavyweight when it comes to functionability. It can do so much. In fact, it can just about do anything your IBM PC can do, or your Apple II plus can do.

Sounds unbelievable, right? Well, take a good look at the Quadlink. What you'll see is an apparently disorganized conglomeration of circuits and chips interspersed across a green board. But immersed in this seeming hodgepodge is circuitry which supports 64K of on board RAM, or random access memory; a 6502 microprocessor; circuitry which supports three screen display modes, a keyboard, and an audio output. There is a game port, disk and video display interfaces, plus memory for use with BASIC, monitor routines, and any input/outputs you may want to utilize.

If you know even a little about the operation of a computer it will dawn on you now that the Quadlink is much more than an expansion card or a computer enhancement. You will realize that what you are holding in your hand is a self-contained computer.

In fact, if you were an engineer or an experienced technician, you could wire the Quadlink to a power supply, a monitor, and a disk drive and run it independently of any other computer. And that's pretty impressive for a circuit board the size of one of Wilt Chamberlain's bedroom slippers.

So the Quadlink is really a computer you plug into the IBM Personal Computer, giving you, in effect, a computer within



a computer. But even though the Quadlink shares the same space and some of the same hardware as the PC, it remains self-sufficient and independent of the PC at all times.

Provided with the Quadlink are three cables. When the Quadlink is installed, they are attached to the printed circuit board. These cables are used to integrate -- to "link" the board with the Personal Computer. We'll discuss the use and installation of these cables later in the manual.

That is the hardware. Now put down the board and let's turn our attention to the next part of the Quadlink package: the documentation.

## THE DOCUMENTATION

Next is the documentation, the user's guide. This guide will help you become familiar with the workings of the Quadlink. It is divided into sections which highlight the way the board works in your Personal Computer. In the INSTALLATION section you'll read how to attach the cables to your board and setup the Quadlink in your system; plus you'll read how to prepare a Quadlink System disk to activate the Quadlink in your PC when you are ready to use it.

In the OPERATION section you'll begin to see how the Quadlink works after it's been installed. In this section the various display screen modes are discussed along with how each one is used; the keyboard is detailed, with emphasis on the different ways the keys are used in the IBM and the Quadlink modes; there is a discussion on the use of any installed input/output devices in your PC; and a general list of keyboard commands and their functions is given.

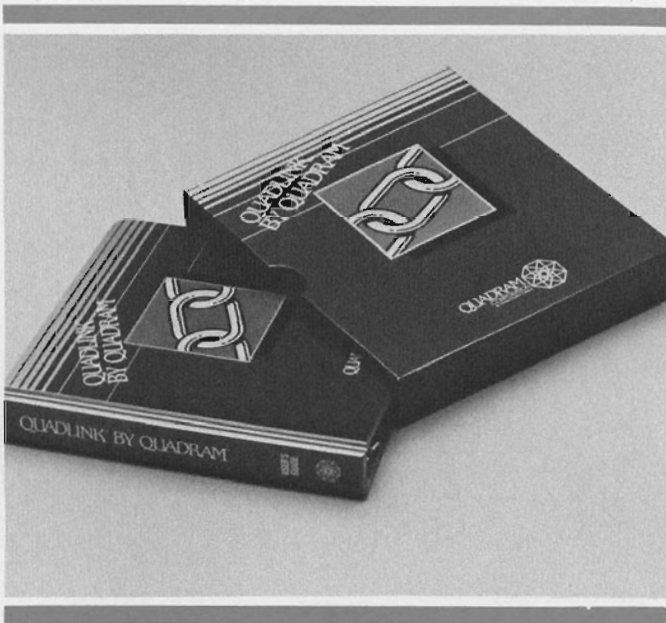

*The user's guide*

The next section, DOS, contains a complete description of the way your Quadlink uses the IBM PC's disk drives with the Apple 3.3 DOS software. Included here are all the necessary disk commands, a detailed listing of Quadlink generated DOS error messages, plus some DOS commands to help you access binary information if you want to.

In the subsequent sections, we'll discuss any problems you might encounter and how to remedy them, we'll look at a sample work session to see how the Quadlink may typically be used. In the end of this guide is included a listing of some popular software that can be used with the Quadlink, plus there's a list of related literature for those who want to explore more about how the Quadlink really works and what it's related to. There's also a glossary in the back to help you with any unfamiliar terms you may come across in reading this guide.

Just reading this guide, though, won't make you a Quadlink expert. You will have to get involved with the Quadlink to become that. Play around with it. Experiment. Hands-on experience is the best way to learn. It will teach you more than this guide ever will.

## **THE SOFTWARE**

The software is stored on the floppy disks found in the back of this manual. There's really no point in you examining these disks closely. Unlike the printed circuit board, you won't see anything. The software is nothing but electronic



*Quadram's Quadlink with two software disks: one with the Quadlink's DOS and the other with a boot program.*

impulses stored magnetically on the disk. These impulses are interpreted by your system's disk drive in the same way a tape player reads a magnetic tape. The impulses are translated by the disk drives into programs that enhance the operation of the Quadlink in your PC. These programs are written in special codes, computer languages which tell all the thousands upon thousands of circuits how to act to store, retrieve, and utilize information.

You should always be very gentle with a floppy disk. It is extremely delicate. If it is ever handled too roughly, the information the disk contains may be damaged or destroyed completely.

## THE SOFTWARE DISKS

One of the disks you will find is marked Quadlink System Disk. This disk contains the program to activate the Quadlink in your system and is called appropriately enough the Quadlink boot program.

As the first thing done when you've opened the Quadlink package, let's move this boot program over to the DOS disk now. This is easily done. All you'll need is a copy of your IBM DOS disk - which you should already have - and the Quadlink System Disk which you should have found in the back of this guide.

The following discussion assumes that your system has two drives. If your system has only one drive, the system will prompt you when you should change disks.

To begin with, put an IBM DOS system formatted disk Drive A.

Put the Quadlink System Disk in Drive B.

Then boot the system by turning on power to the computer.

When you get the DOS prompt - A> -Enter in:

Copy B:\* A:

When you press the return key you should get a statement telling you that the files have been copied.

When this is done you can put the Quadlink System Disk away. You will not have to use it again until you wish to make another copy of its programs.

NOTE to Quadram's Quadboard Owners:

If you already have an IBM DOS disk with an autoexec.bat file housing the QuadRAM Drive and PWRUPCLK programs you should include the Quadlink program like this:

Put the DOS disk in drive A and the Quadlink System Disk in B and type the following sequence:

Copy Con: AUTOEXEC.BAT (RETURN)

QD N/A (RETURN)

*(N is the number of 32K blocks you choose)*

PWRUPCLK (RETURN)

Quadlink <F6> (RETURN)

*(F6 is the function key)*

Then press the F6 key, return, and you're done.

The next disk you will find is called the Filer. This disk contains the Apple DOS 3.3 software needed to help run the Quadlink. We will refer to this disk throughout this guide as the Filer disk, the DOS 3.3 disk, or the Apple DOS 3.3 software.

Also available on this disk is a collection of software utilities. These utilities are discussed later on in this manual.

## INSTALLATION

Now that we know the Quadlink package is complete -- all the different pieces present -- we can open the IBM and install the Quadlink in the computer. For this task, you will need just two things: a small standard (flat-head) screwdriver and a little patience.

NOTE: In this section we will be referring to the Quadlink from this vantage point: the end plate with the two nine-pin connectors is always on the right, and the two gold finger connectors are always on the bottom of the board.

### GETTING THE QUADLINK READY

Before doing anything else though, let's attach the flat disk controller cable and the yellow and black speaker cable to the Quadlink board. Pick up the disk controller cable and locate the male 34 pin connector found just above the rim of goldfingers near the middle of the Quadlink. Into this male connector plug the white, female 34 pin connector of the flat controller cable with the cable extending downward. (See picture on following page)



Next, locate the set of six golden pins on the lower left corner of the board. The female end of the yellow and black speaker cable is attached here so that the female end of the connector plugs into the 3 left-most pins -- the 3 farthest from the gold fingers -- with the silver tipped side facing toward the printed circuit board. For the proper location of these two cable hook-ups, see the diagram below.

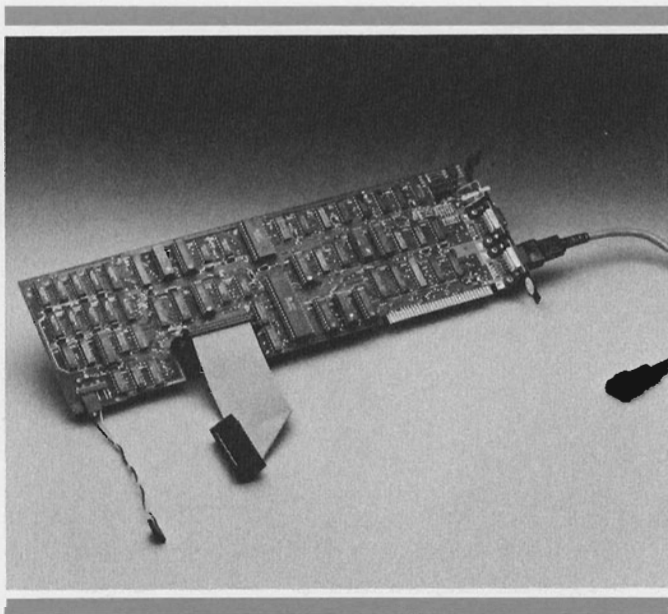

*The printed circuit board comes with three separately packaged cables. These cables consist of (from left to right) (1) a yellow and black speaker wire with female connectors on either end. This wire is plugged into the gold pin connector on the lower left corner of the board. This hookup should be made so that the silver tipped side of the wire's connector is facing the board. (2) A grey, flat ribbon cable with two 34 pin female connectors on each end. This cable plugs into the 34 pin connector found just above the rim of gold fingers near the center of the board. (3) a nine-pin female sub mini D-type connector cable. This cable is hooked to the Quadlink's lower nine-pin. The game paddle connector (paddles optional) is located just to the left of the phone jack on the right upper edge of the board.*

With the cables attached to the board you can now open the PC and plug in the Quadlink. The remaining cables can be attached as the installation proceeds.

**WARNING:** Before going any further, turn off all power to the PC and disconnect any attached power cables. Installing the Quadlink with PC's power on could result in damage to the PC, the Quadlink, or you! Turn off the power and disconnect the AC power cord NOW.

## OPENING THE PC

With the power off and the cables disconnected, unhook the monitor and the keyboard and set them aside. This will give you a little working room. Next, position the computer so that the back panel is facing you as shown below.

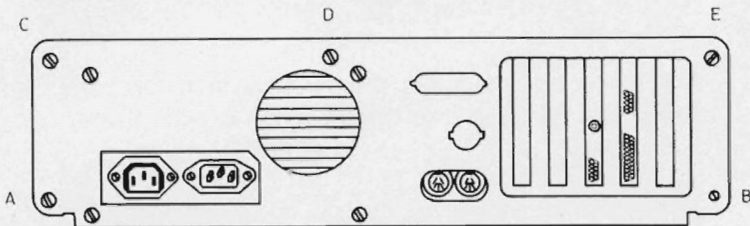

To open the computer the cover will have to be removed from the chassis. This is done by loosening two screws located at either end of the rear panel. These screws are marked A and B above: With your screwdriver, remove

(Note: Newer PC's require removing C, D, and E)

these two screws and put them aside for later. Then, gently slide the cover of the computer away from you, towards the front of the computer, until the inside circuitry is exposed.

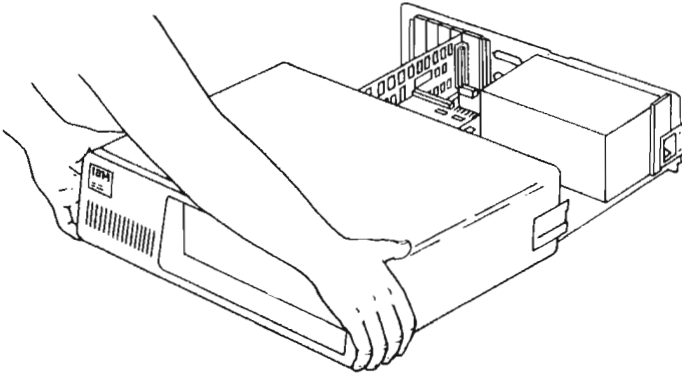

*Pull the cover off until the inside circuitry is exposed.*

Now, if you look down into the computer from the rear panel you'll see the guts of the PC: the computer's main circuit board.

On the left will be a silver box housing the power supply; towards the front will be the disk drive assembly; and near the rear panel, on the right side of the board, will be five elongated connectors called expansion slots.

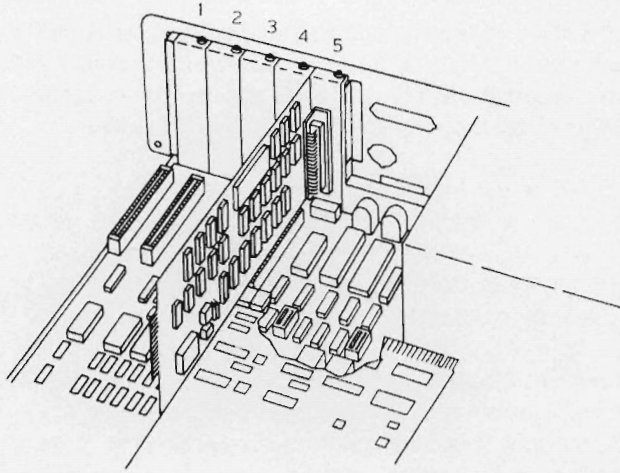

*The five expansion slots on the mother board are used to accommodate expansion cards.*

## **THE PC'S EXPANSION SLOTS**

For location purposes, let's call the slot nearest the right chassis wall slot #1 and the slot nearest the power supply slot #5.

Depending on your own individual set-up, these slots may already be occupied by other expansion boards. You may have a Quadboard or a Memory Expansion card installed; you may be using a parallel interface card or a serial adapter. But, whatever else you've got working in your PC, in all probability, two of the slots will be taken up with 1) a video display card which sends information to your monitor screen, and 2) a disk controller card which controls the operation of the IBM's disk drive.

Of course, the Quadlink is also installed into one of these expansion slots. Were it not for a few physical limitations,

any slot at all would accommodate the board. However, the Quadlink must not only be installed into one of the available expansion slots, but it must also be cabled to the disk controller card, the video card, and the PC speaker.

Because of the length of the internal wires and cables necessary for the hook-up, Quadram recommends installing the Quadlink in Slot #4. This will provide enough room to comfortably connect the Quadlink to the parts of the PC system where these connections need to be made.

Before the Quadlink can be installed, though, it is advisable to first remove all the other boards you currently have plugged into your system. There are some tight internal cable connections to be made here, so you'll need as much room as you can arrange.

So pull out all the boards now, keeping them close by.

Before the Quadlink can be inserted into the slot #4, it must be connected to the disk controller cable.

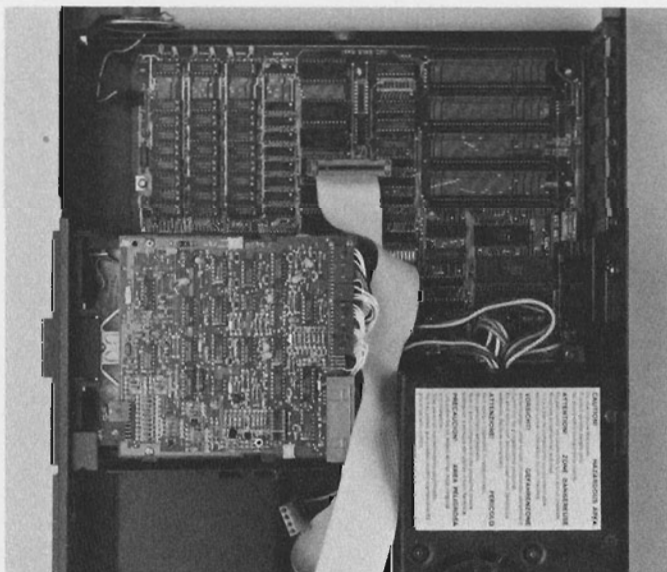

*To make room for installation of the Quadlink, remove all expansion cards from the system mother board and position the disk controller cable next to expansion slot #4. Now you are ready to begin.*

## THE DISK CONTROLLER CABLE CONNECTION

The disk controller cable in the PC will already be attached to any disk drive you already have installed in your system. Typically, there are three connectors to this cable, marked J1, J2, and J3. The connector J1 is normally hooked to the connector on the disk controller card. J2 and J3 are attached to the connectors of the system disk drives.

When the Quadlink is installed, the cable attaching the disk controller card to the disk drive(s) will have to be removed from the card when you take the card out of the system and routed across the floor of the main logic board. The cable's J1 connector should be positioned so that the middle rim of gold fingers on the lower edge of the Quadlink slides into the connector easily. This connection is shown below.

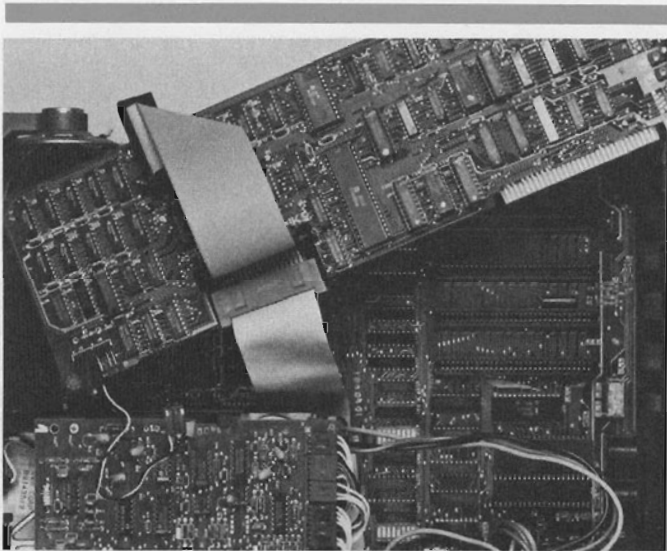

*Attach the disk controller cable into the lower rim of gold fingers located near the middle of the board. Make sure the connection is snug and the pin numbers on both connection points match.*

## ROUTING THE SPEAKER WIRE

There are two small wires that need to be connected. Both are needed for the operation of the computer's speaker, or bell. The speaker wire you previously installed on the Quadlink contains a connector at one end that hooks into the computer's mother board at the connector labeled P3. This connector is found just to the left of the speaker as you view the mother board from the rear panel. To make this connection, you will first have to remove a plug already installed there. This plug runs straight to the speaker. It is replaced with the plug at the end of the Quadlink's speaker wire.

The freed plug from the speaker is then routed to the Quadlink. There it is attached to a similar connector (J6) as that on the mother board, this similar connector being the 3-right-most golden pins found next to the speaker wire already on the Quadlink. The plug should fit snugly into the connector pins.

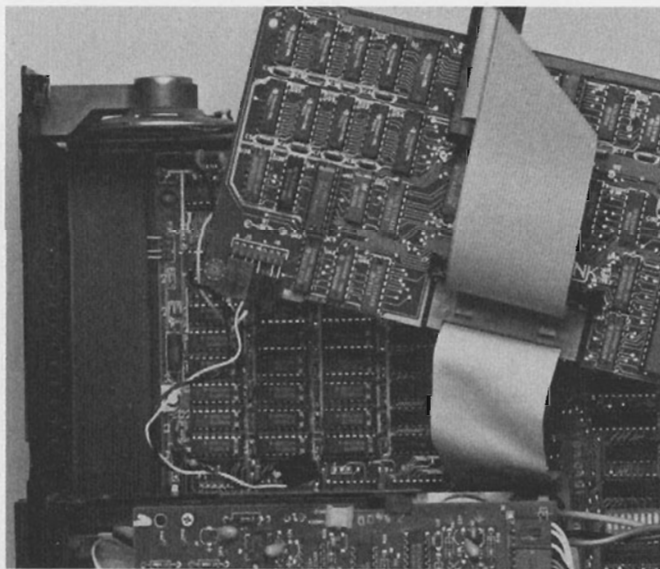

*Detach the speaker wire from the mother board connector and reroute the wire to connect it into the right-most gold pins located on the lower left corner of the board, next to the Quadlink's installed speaker wire.*

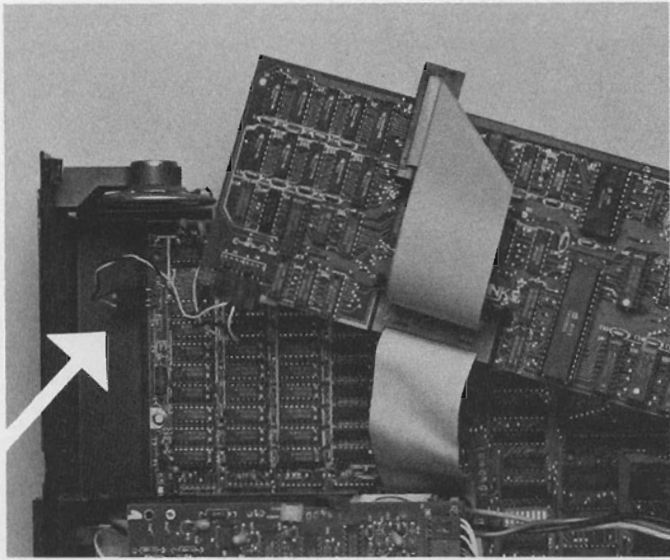

*Take the free end of the Quadlink's speaker wire and insert it into the mother board connector. When this is done the speaker will be wired through the Quadlink back to the mother board.*

## **CONNECTING THE GAME PADDLES (OPTIONAL)**

If you choose to install game paddles on the Quadlink, this should be done next. The game paddle connector is found in the upper right area of the board, above the video display connector on the Quadlink. It is a sixteen pin DIP socket designed to fit the male connector on the end of the game paddle cable. Plug the male connector in here, making sure of proper orientation of the plug.

Make sure you route the game paddle cable through the IBM slot opening in the back first. If you try to route it through after you plug in the connector you'll experience the frustration of having to force the paddles through the slim opening. Naturally this is an impossibility.



Just above the disk controller cable connection point you will notice another similar type cable, the flat cable you hooked to the board earlier. This cable flows out from the Quadlink and should be routed to the disk controller card you have removed from the system.

## **SLIDING THE QUADLINK INTO THE EXPANSION SLOT**

Before this cable can be connected to the disk controller card, the Quadlink should be snapped into expansion slot #4. This is done by pressing the gold fingers near the front of the board -- right under the front sockets and the attached cover plate -- gently into the slot. As you do this, the attached cover plate should slide naturally into position over the corresponding opening in the rear chassis. This is demonstrated below. Before going any further, make sure the Quadlink is well-seated in the expansion slot.

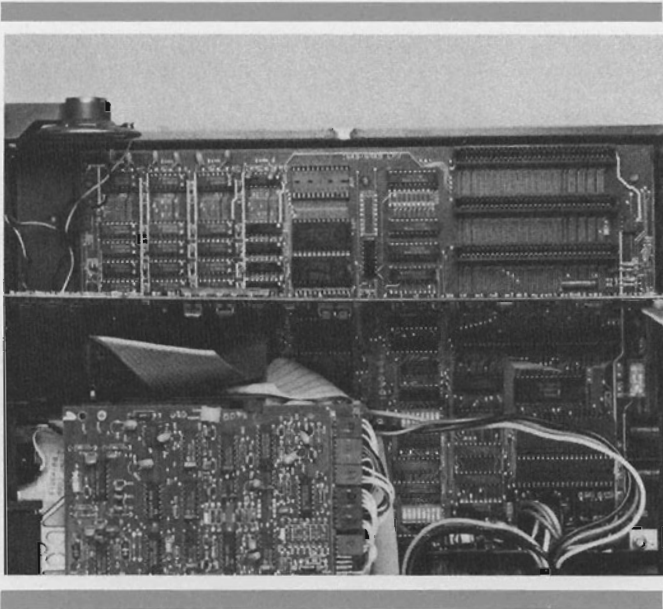

*Snap the Quadlink's right rim of gold fingers down into expansion slot #4 on the system mother board. The board can then be secured in place by screwing the cover plate down into the top of the chassis.*

At this point, you should have three connections made to the bottom of the board: the disk drive unhooked from the disk controller card and attached now to the Quadlink; the speaker wires routed through the Quadlink; and the Quadlink plugged into expansion slot #4 on the PC main logic board.

## THE DISK CONTROLLER CONNECTION

Now the disk controller card can be reinserted. This card is best installed in expansion slot #5, where the disk cable coming out of the Quadlink can easily connect to the gold fingers on the end of the disk controller card. Route the cable up to the connector properly. Then gently push it over the gold fingers until it fits snugly.

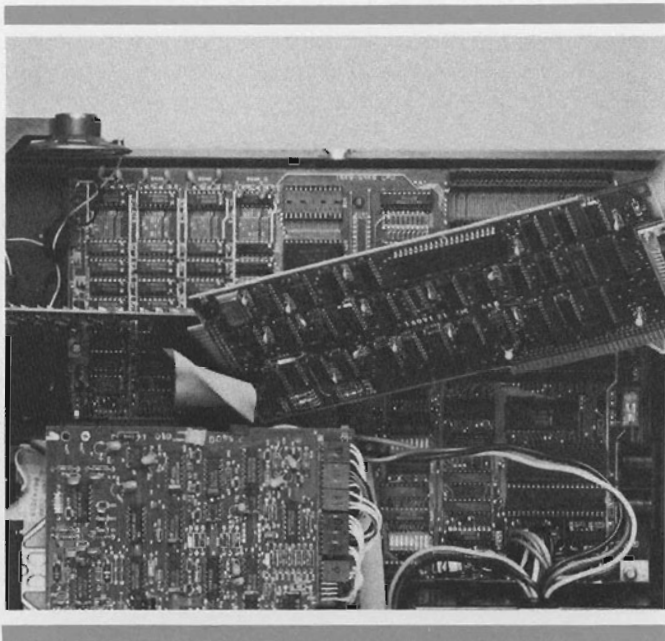

*Attach the Quadlink's disk controller cable to the left edge connector of the system's disk controller card. Again, make sure the pin line ups match as the connection is made. Then insert the disk controller card into expansion slot #5.*

## THE VIDEO DISPLAY CONNECTION

That takes care of the internal wiring as far as the Quadlink goes.

Next the Quadlink must be properly attached to the IBM's video display card. This connection is made externally. Included in the Quadlink package is a cable with two nine-pin sub mini D-type connectors on each end. The cable is hooked into two external nine-pin connectors located on the cover plates of the video display card and the Quadlink.

Reinsert the video display card into expansion slot #3, checking to make sure that the board's cover plate is properly seated against the chassis opening. Both connectors on the nine pin cable are males, so either end will connect to either board. Connect this cable to the lower nine-pin socket on the Quadlink and to the only nine-pin socket protruding from the video card.

If you are using the IBM monitor or an RGB color monitor, the monitor cable will plug into the upper nine pin sub mini D-type socket located on the Quadlink. If you are using a composite monitor, the monitor cable will plug into the standard phone jack plug located just above this nine pin sub mini socket. The monitor cable will no longer plug into the video display card.

If you have been following instructions closely, you will now have made six connections. You will have attached the Quadlink to the disk controller cable at J1; you will have installed the Quadlink board into expansion slot #4; you will then have cabled the Quadlink to the installed disk controller card; you will have disconnected the speaker wire and routed it to the Quadlink, while wiring the Quadlink to the mother board; and you will have externally connected the Quadlink to the video display card. (You may also have connected the game paddle, too.)

If you have any doubts about any of these connections, go back and check them all against the instructions and the illustrations on these pages. If the Quadlink is set-up wrong, it will not work properly in your PC.

Once you are confident the installation has gone smoothly, you should reinstall any other option boards you have been using in your IBM PC. After these are installed, you can pick up the screwdriver again and get ready to replace the computer's cover.

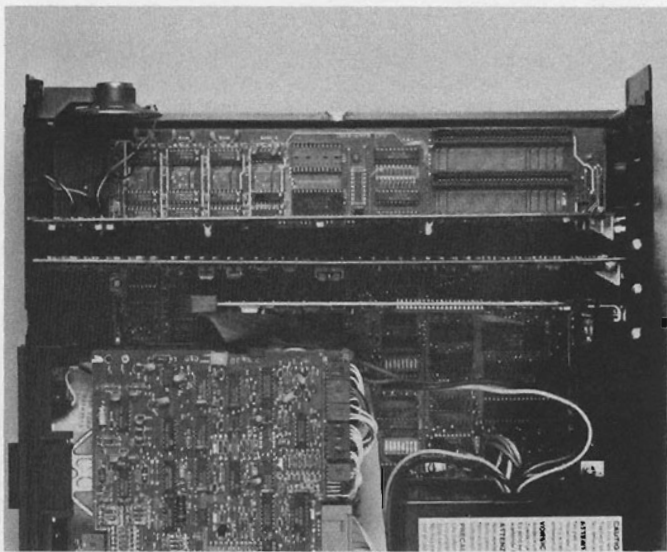

*The video display card can then be inserted into expansion slot #3 on the system board. And any other expansion card or Quadram enhancement board you are using can be inserted into the remaining slots at this point.*

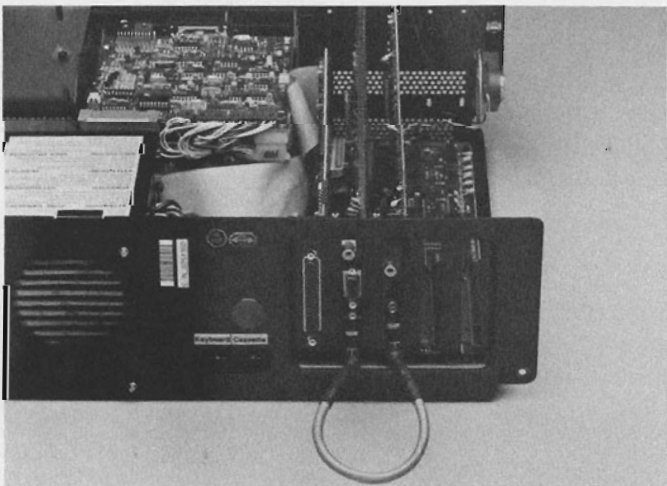

*Take the video cable and attach one of the female nine-pin sub mini D-type connectors into the lower nine-pin connector on the Quadlink end plate. Take the other end and connect it into the nine-pin connector on the video display card.*

## PUTTING THE PC BACK TOGETHER

The cover is replaced in the reverse order from which it was removed. Gently slip the cover back over the lower chassis grooves and slide it back towards the rear panel. It should fit comfortably around the chassis with the cover just overhanging the rear panel. Here you can use the screwdriver to insert and tighten the two screws you removed in the beginning.

With the cover on, you don't need that extra working room anymore. So round up the keyboard and the monitor and reattach them to your system.

**NOTE:** When you have a color composite monitor hooked into the Quadlink via the RCA phono plug, your display will not exhibit color in either the Apple or IBM mode. The color composite capabilities for the Apple mode are not supported on the Quadlink. If you wish to exhibit color in the IBM mode you will have to disconnect the monitor from the Quadlink and reroute it to the IBM's video card as if the Quadlink were not there.

### **Monochrome Display and the Quadlink**

Quadlink cannot be used in the same system with IBM's Monochrome Display without a 30 to 40% reduction in the screen viewing area because of the Monochrome Display's non-standard sync rate. And, since no other screens will work with the IBM Monochrome Adapter card, you will need to replace both the display and card units before you can enjoy normal, full-screen viewing while using your Quadlink. A standard RGB monitor or a composite green screen will work fine with Quadlink when used with an IBM Color/Graphics Monitor Adapter card or an equivalent, such as Quadram's own Quadcolor card.

The keyboard cable still plugs into its old socket. With these two reconnected to your system you can now plug in the power cables you pulled out and plug the cable back into a wall socket.

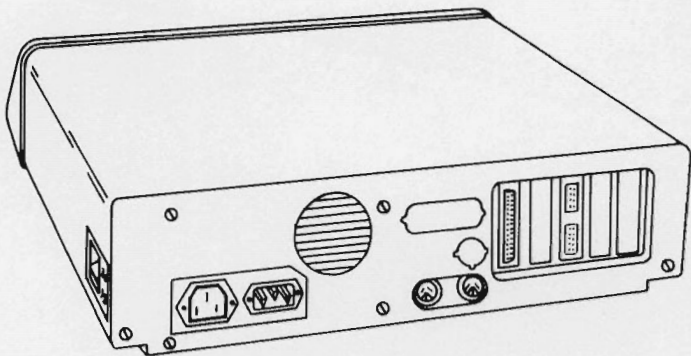

*The cover reinstalled.*

And that's it!

The Quadlink is now installed in your system. And your system has now become super charged: capable of using more than twice the software that it normally could, capable of doing anything from using Apple II + word processing packages to shooting aliens out of the sky with Space Raiders.

So be careful: you're about to have more than twice as much fun using it, too.

## OPERATION

With the Quadlink boot program properly copied onto the IBM DOS disk and Apple DOS 3.3 software present on the Filer Disk, we can get down to the business of turning the Quadlink "on." The first thing to do is to make sure the PC has been properly reassembled and is ready for operation. Is the chassis screwed on tight? Are the power cords plugged in as they should be? Are all system peripherals reattached as before?

Once you are sure everything checks out, put the IBM DOS disk with Quadlink boot program into Drive A. Then turn on the computer. The disk drive will begin to hum at this point as the disk begins to spin booting the system with DOS. When this spinning stops the computer will have installed the Quadlink boot program into system RAM automatically. When it is ready you will see a greeting statement and a prompt to insert the Filer disk. When the Filer disk is inserted in the disk drive, press any key. After this, the DOS prompt will reappear. Pressing CTRL ALT A will take you into the pre-Quadlink mode. Pressing CTRL ALT DEL now loads Apple DOS.

When this happens you'll see displayed on the screen the Filer copyright notice and a utilities menu. Ignore this menu for now and press the ESC key. This takes you into the Quadlink mode and you are ready to go.

Also, when you are using the many Apple-compatible pre-packaged programs available for the Quadlink, you can get them running in the Quadlink by booting the DOS 3.3 first, then inserting the program disk into the drive and typing PR#6.

Once you are actively working in the Quadlink mode you can at any time switch back to the IBM mode by pressing

CTRL ALT I

This takes you out of the Quadlink mode with your program in its same state: if it was running it will continue to run while you work in the IBM mode; if you were just looking at an Apple prompt, that's where you'll be when you return.

If after working in the IBM mode for a while you wish to return to the Quadlink mode, simply press

CTRL ALT A

Using these two commands, you can go back and forth between modes as often as you wish.



## THE QUADLINK MODE

Once you are in the Quadlink mode you begin working with a different computer. The Quadlink does not work quite like the IBM PC. In fact, its operation is different from the PC's in quite a few respects. So before you can dive right into this new computing mode you will want to take a look at some of the operational characteristics of the new mode.

## THE KEYBOARD

Naturally, the keyboard used in the Quadlink mode is the same keyboard used in the IBM mode. But in the Quadlink mode some of the key functions take on new meanings; some of the keys are used for certain things that are never applied in the IBM mode. This difference is due to the fact that the Quadlink processes programs in a slightly different way from how the IBM PC system board processes programs. Because of this, some of the keys that tell the IBM to do certain things tell the Quadlink to do other things.

But don't become alarmed over this. Don't slap your forehead and cry, "I've got to learn the key functions all over again? How do I do that?"

Actually, the differences in the use of the keyboard between these two modes is only minor. You'll only have to remember a few new commands, and this can be done very easily. To see just what these differences are, let's examine the PC keyboard and look at what the various parts are used for.

The IBM keyboard can be divided into three sections, with each section serving a specific function for data processing. From left to right, the three sections are: the function keys, the standard keypad and the numeric keypad.

## THE STANDARD KEYPAD

The part of the keyboard that concerns most users is the standard keypad. This is the middle and largest part of the IBM keyboard. It contains what most people call the standard typewriter keys, that is the keys most people are used to working with on a typewriter. These keys are the letter keys, the number and symbol keys, the punctuation keys, the shift key, and the space bar.

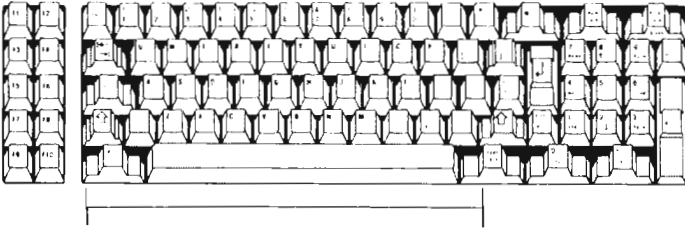

## THE CAPS LOCK KEY

In the Quadlink mode, this key also works the same way as on a typewriter, but with one small difference. When you first enter the Quadlink mode, the caps lock key is automatically locked and stays locked. The reason for this is the Quadlink expects all information to be entered in upper-case form.

## **THE ESCAPE KEY**

Another key that works a little differently in the Quadlink mode is the ESCAPE key, marked on the keyboard as ESC. This key is always used in conjunction with one of the other keys on the keyboard, either to edit data already on the display screen or to change the input location for data coming onto the display screen. There are 18 of these ESC commands. Twelve are concerned solely with changing the location of the cursor on the screen. Let's look at these first.

### **MOVING THE CURSOR RIGHT**

To move the cursor one position to the right on the screen press ESC along with the A or K keys or the right arrow key on the numeric keypad. The cursor is moved one character position to the right with each combination of ESC A and to repeat the movement, the entire key combination must be reentered. But if you use ESC K instead, or ESC Right Arrow, the cursor move right can be repeated as often as you like by simply pressing K or Right Arrow after the initial combination has been made. This sequence is not broken until another key on the keyboard is pressed.

### **AND MOVING THE CURSOR LEFT**

To move the cursor position one space left, or backward, on the screen press ESC along with the B or J keys or the left Arrow key on the numeric keypad. As in the manner above, the cursor is moved one character position to the left with each combination of ESC B and repeating the movement requires reentering the entire key combination for each space left desired. Using ESC J it is possible to repeat the command by simply pressing J after the initial combination has been made. The same is true for ESC Left Arrow. And this sequence is also not broken until you press another key on the keyboard.

## **AND DOWN**

Using ESC with the C or M keys or the Down Key on the numeric keypad allows you to move the cursor position down one line on the screen. ESC C and ESC Down Arrow both move the cursor position one line down. To repeat the move with ESC C, the entire command must be repeated. With ESC M, as with ESC J, K, and (as we'll see) I, the command can be automatically repeated by simply pressing M after the initial combination has been made. The same is true for the use of ESC Down Arrow. The sequence is broken when you press another key.

## **AND UP**

To move the cursor position up one line use the ESC key in combination with the D or I keys or the Up Arrow key on the numeric keypad. To repeat the command action the D key must be used in combination with the ESC key for each position move desired. The I key need only be combined once with the ESC key, then the position move can be repeated (until another key is pressed) by simply pressing the I key. Again the Up Arrow key on the numeric keypad works the same way.

The following six commands not only change the position of the cursor on the display screen but also alter information you have placed on the display screen.

## **CLEAR TO THE END OF THE LINE**

When you want to clear from the cursor to the end of the line you are working on you can use ESC with the E key. ESC E erases everything that is to the right of its position in the line. You can accomplish this same thing by using ESC and the END key on the numeric keypad.

## **CLEAR TO THE END OF THE SCREEN**

If you want to clear from the cursor's original position to the end of the window, use ESC F on the numeric keypad, or you can use ESC PGDN.

## **OR THE BEGINNING OF THE SCREEN**

Finally, when you want to clear the screen completely and send the cursor to the "home" position -- the upper left hand corner of the screen -- use ESC HOME on the numeric keypad or ESC @.

Other than these new functions, the keys in the standard keypad part of the keyboard work alike in either the IBM or Quadlink mode. Since this is the part of the overall keyboard that you use the most, this should come to you as good news.

## **THE CONTROL KEY**

As an example, the CONTROL key (CTRL) works in the Quadlink mode in much the same way that it works in the IBM mode. The CTRL key sends an action code to the Quadlink, a command telling the Quadlink to do something, to act in some preprogrammed way. Just like in the IBM mode, the CTRL characters you type in never appear on the screen.

Many of the Quadlink CTRL commands are used as "mode-access" commands. These commands are used to get into and out of the IBM and Quadlink modes, to get into or out of the two forms of BASIC available with Quadlink, and to begin working with the Quadlink after a cold start or a warm start.

Let's take a look at the commands.

**CTRL-ALT-DEL:** Cold Start. This key operates the same way that the CTRL-ALT-DEL combination works in the IBM mode. When pressed, it causes the Quadlink to be reset and reboot DOS 3.3 from drive A. It is as if you turned the system power off then on again. After pressing CTRL-ALT-DEL, all data stored in the Quadlink's RAM (random access memory) is lost, as is the nature of volatile memory. The Quadlink at this point tries to reboot Drive A for DOS 3.3.

**CTRL-BREAK:** Warm Start. This takes you out of the program you were in and returns you to a predetermined state as set-up in the program you are running. All the data you were working on is still intact as you left it.

**CTRL-ALT-A:** Link Mode. The Link Mode command does just about what it says it does. It lets you continue in the Quadlink mode after you've been working in the IBM mode. This is all that it is used for. When you come back to the Quadlink mode after switching from IBM mode, you take up in the Quadlink program exactly where you left off previously. If you had just booted-up, you would return to that stage; if you were just ending a complicated BASIC program, you would be taken back to the last line you entered. If you left it running you would return to it either still running or completed.

**NOTE:** These first three are the commands you use to enter the Quadlink mode once the PC has been powered-up and the Quadlink has been initially activated at boot-up. With CTRL-ALT-DEL you go into Quadlink mode for a fresh start on whatever project you need to work on; with CTRL-ALT-I, you leave whatever you've been working on in Quadlink mode to get into the IBM mode; and with CTRL-ALT-A, you go back into Quadlink mode after having worked a while in the IBM mode.

The remaining commands perform specific functions in the Quadlink mode, functions which enhance the operation of your programs in this mode, provided the Quadlink is running under DOS 3.3.

**FP:** Floating Point BASIC. Typing in FP activates floating point BASIC in the Quadlink mode. It allows a person in this mode to write programs using floating point BASIC. Floating point BASIC is nothing other than a form of the computer language which expresses positive or negative numbers in exponential form, a form similar to scientific notation.

**INT:** Integer BASIC. Entering INT activates Integer BASIC in the Quadlink mode. Integer BASIC deals with the whole numbers between -32,768 and +32,768. Unlike floating point BASIC, in Integer BASIC integer constants do not have decimal points. This requires that the Quadlink was booted with DOS 3.3 Master or equivalent.

**Note:** The file required for this command "INTBASIC" is not on the the Filer diskette. Therefore if the user types this command the DOS will issue a "LANGUAGE NOT AVAILABLE" error message.

This form of BASIC is becoming less and less used as Floating Point BASIC becomes more and more popular.

One thing you should remember about using the keys on the keyboard in either the IBM or Quadlink modes is that they are always self-repeating. That is, when you hold a key down for longer than .5 second, the character code for that particular key is regenerated by the keyboard and sent to the computer again.

## THE F-KEYS IN THE QUADLINK MODE

The next section of the keyboard is located to the immediate left of the standard keypad. This is the section of ten keys called the function keys. These keys are marked F1, F2, and so on, up to F10.

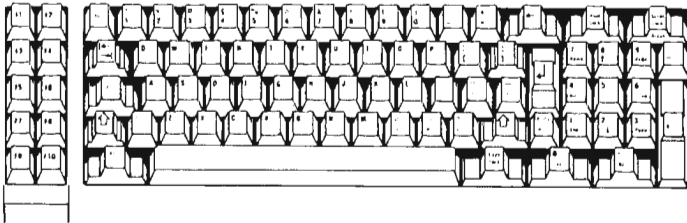



In the IBM mode, the function keys perform certain programmable operations that replace CONTROL commands issued from the standard keypad. The function keys serve as a shortcut to initiating these commands. For instance, when using IBM BASIC, the F2 key gives the RUN command when pressed, saving you from having to type another line into your program.

Each of the other ten keys performs a like function. For greater detail on the use of these keys in the IBM mode, consult IBM's "Guide to Operations" manual for the Personal Computer.

In the Quadlink mode, however, the majority of these function keys are not user-programmable; they remain undefined. But only one of the F keys does work in the Quadlink mode: F2.

The F2 key is a toggle switch for color kill in Hi-Res mode. Press it once, it's on; press it again, it's off. The function F2 performs controls the monitor's color display ability. With F2 on, the color capabilities -- if any -- are allowed. With F2 off, only black-and-white is supported.

This key is for PC system owners who have either an RGB color monitor or a composite monitor working in their systems. In the Quadlink mode, this key enables or disables the color circuitry in the Quadlink.

When off, the screen display is black-and-white. When on, the screen can display color again. This feature may come in handy in certain circumstances where the quality of the screen image is improved when the color circuitry is disabled.

With most of the F Keys not applied in the Quadlink mode, the Quadlink commands are necessarily entered through the standard keyboard keys.

## THE NUMERIC KEYPAD

The keys on the right side of the keyboard -- those to the right of the RETURN key -- are collectively called the numeric keypad. In IBM mode, these keys are most often used for program editing. They contain the cursor direction keys, insert and delete keys, and the number and scroll lock keys. In the IBM mode, these keys can be used like the keys on a pocket calculator by depressing the NUM LOCK key.

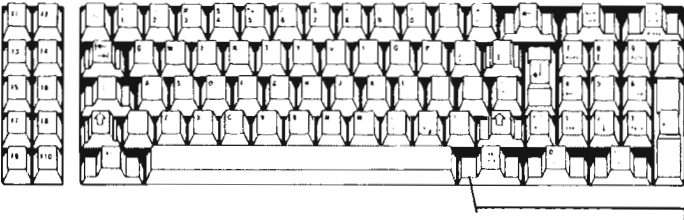

## **NUM LOCK**

In Quadlink mode, the NUM LOCK key is automatically depressed. The left arrow key is then used as the left cursor position key and the NUM LOCK key is used as the right cursor position key. These two keys are commonly used to reenter information on the display screen. The lower insert key (INS) is used as the numeric keypad's zero and the delete key (DEL) is used as the decimal point for floating point BASIC.

The keys PRTSC and SCROLL LOCK remain undefined in the Quadlink mode.

Now, those differences should not seem very major. The keyboard changes between modes may at first sound as if they are involved and numerous. But, after a little practice, you should be able to switch back and forth between modes and have no problems with the keyboard transitions at all.

Go ahead and practice a little. You'll soon agree.

## **THE SCREEN**

Just as they share the same keyboard, the IBM PC system board and the Quadlink share the same monitor, too. Yet the way in which the two present screen information is a little different from each other.

The presence of the Quadlink in the PC in no way alters the IBM's use of the monitor. Nothing about the presentation of data on the screen is changed when you are using the system to run any of the PC-compatible programs.

When you switch over to the Quadlink mode, however, there are certain differences which arise that you should be aware of. To begin with, when you are using the Quadlink to run programs you have access to three different video display modes. These three modes are called Standard Text Mode, Low-Resolution Graphics Mode, and High-Resolution Graphics Mode.

## THE STANDARD TEXT MODE

The Standard Text Mode. In the Standard Text Mode the PC system monitor is capable of displaying 24 lines of 40 characters each. The characters are made up of a matrix 5 dots wide by 7 dots high. A one dot space separates each of the characters. The character set available in the Standard Text Mode includes the upper-case and lower case forms of the 26 letters in the alphabet, 33 special characters, plus the 10 digits.

Text mode is the default screen mode whenever the Quadlink is being used. It is the mode that appears on the screen when the Quadlink is freshly booted. Standard Text mode is used for both Floating Point and Integer BASIC programming, and more than likely it will be the screen mode you most often use when you are programming with the Quadlink.

In Floating Point BASIC, whenever you leave the text for one of the other screen modes described below and then wish to return to the text mode without having to reboot Quadlink, simply type in the command:

TEXT

Press enter after this and the screen will enter the text mode with a BASIC prompt showing.

Looking at the screen, a person can tell he is in the Standard Text Mode when he sees text on the screen. If a person does not see text on the screen, but instead sees an array of small square blocks, he is in the Low-resolution Graphics Mode.

## LOW-RESOLUTION GRAPHICS MODE

Low-resolution Graphics. In the Standard Text Mode, each byte of information processed by the Quadlink is used to form a text character: a letter, number, or one of the special symbols. In the Low-resolution Graphics Mode, this same byte is now processed to form two small blocks, one on top of the other, on the screen. In this mode, you can display up to 48 lines containing 40 of these double blocks. On a color monitor each of these blocks can be any one of 16 colors. On a black-and-white monitor, the color intensities show up as varying shades of grey.

To vary the intensity or color of each of these blocks it is necessary to first reference each block to a particular value from 0 to 15. Since each block is actually based on the information in one-half byte, or "nybble," one byte controls two blocks. By giving the lower nybble in a byte a value, the color of the upper block is changed. By giving the upper nybble in a byte a value, the color of the lower block is changed.

The values from 0 to 15 provide the blocks with the colors in the following manner:

Decimal	Hex	Desired Color
0	\$0	Black
1	\$1	Dark Red
2	\$2	Dark Blue
3	\$3	Dark Purple
4	\$4	Green
5	\$5	Lemon
6	\$6	Light Blue
7	\$7	Gray
8	\$8	Black
9	\$9	Red
10	\$A	Blue
11	\$B	Purple
12	\$C	Light Green
13	\$D	Yellow
14	\$E	Aquamarine
15	\$F	White

When you are in the Standard Text Mode and you wish to enter the Low-resolution graphics mode, make sure you are in Floating Point BASIC. Integer BASIC does not directly support graphics.

To get into Low-resolution graphics from Standard Text simply type in :

GR

This will put you into the Low-res mode, giving you a graphics area with a small text window at the bottom of the screen. If you wish to get rid of this window for full-screen graphics enter in:

POKE -16302,0

To restore the text window, enter in:

POKE -16301,0

## **HIGH-RESOLUTION GRAPHICS MODE**

High-resolution Graphics Mode. The other graphics mode available with the Quadlink is the High-resolution Graphics Mode, a graphics mode composed of dots instead of large squares. The dots in this mode are the same size as the dots in the 5 x 7 characters matrix that forms the characters in the Standard Text Mode.

In the High-res mode, the screen can display 192 lines of 280 dots per line. The colors available in this mode are black, white, violet, blue, green, and red. This color selection is smaller than that for the Low-res mode, and there are also certain restrictions on color placement in the High-res mode that don't apply to Low-res.

For instance, in the High-res mode, the dots in the even columns (0,2,4,6,8 . . .etc.) can only be colored black, violet, or blue. The dots in the odd columns (1,3,5,7 . . .etc.) can only be colored black, green, or red. White can be in any column if two contiguous bits are on.

Additionally, each byte -- seven bits on the screen -- must be either a violet/green byte (violet and green alternating dots) or a blue/red byte (red and blue alternating dots). The eighth bit in each byte is always reserved for the color indicator of that byte and does not appear on the screen.

Like Low-Resolution Graphics, High-Resolution is best accessed through floating point BASIC. Two forms of Hi-Res can be accessed. The first contains a text window at the bottom of the screen, and the second does not.

To get into the page 1 Hi-Res mode with the text window, enter:

HGR

To use page 1 without the text window, do:

HGR  
POKE - 16302,0

To get into the page 2 Hi-Res mode without the text window enter:

HGR2

If you are already in the High-Resolution Graphics mode and you want to switch over to Low-resolution graphics but want to save your Hi-Res image, you will need to use a POKE command:

POKE -16298,0

if you are in the Low-Res mode and want to get into the Hi-Res mode with text window while saving your Low-Res image, enter:

POKE -16297,0

There is really no good way to go from Standard Text Mode to Low-resolution Graphics Mode or vice versa and save anything, because both these modes use the same memory space in the Quadlink.



These three screen modes -- Standard Text Mode, Low-resolution Graphics Mode, and High-resolution Graphics Mode -- are all available to you when you are running programs with the Quadlink. To access the screen display you desire, it is possible to set certain "soft switches" in the Quadlink's software. A "soft switch" is not actually a switch in the physical sense. Rather a soft switch is a command that causes the software in the Quadlink to access the screen mode desired.

The soft switch commands address certain memory locations in the Quadlink and it is this addressing that turns the switch "on" or "off."

The following two tables give the address locations for using the soft switches to control the display screen modes:

<b>Quadlink Soft Switches for the Screen Modes</b>			
<b>Mode</b>	<b>Decimal</b>		<b>Hex Location</b>
Graphics Mode	49232	-16304	\$C050
Text Mode	49233	-16303	\$C051
All Text or Graphics (no window)	49234	-16302	\$C052
Mix Text and Graphics	49235	-16301	\$C053
Primary Page	49236	-16300	\$C054
Secondary Page	49237	-16299	\$C055
Lo-Res	49238	-16298	\$C056
Hi-Res	49239	-16297	\$C057

### Quadlink Soft Switch Combinations

Primary Page		Hex
Standard Text Mode	\$C054	\$C051
All Low-Res Graphics	\$C054	\$C056
	\$C052	\$C050
All Hi-Res Graphics	\$C054	\$C057
	\$C052	\$C050
Mixed Text and Low-Res	\$C054	\$C056
	\$C053	\$C050
Mixed Text and Hi-Res	\$C054	\$C057
	\$C053	\$C050
Secondary Page		Hex
Standard Text Mode	\$C055	\$C051
All Low-Res Graphics	\$C055	\$C056
	\$C052	\$C050
All Hi-Res Graphics	\$C055	\$C057
	\$C052	\$C050
Mixed Text and Low-Res	\$C055	\$C056
	\$C053	\$C050
Mixed Text and Hi-Res	\$C055	\$C057
	\$C053	\$C050

*Quadlink Hexidecimal references show a dollar sign (\$) preceding the value.*

## THE USE OF SHARED I/O DEVICES

One advantage of the Quadlink is that it is capable of using any I/O devices already installed in the Personal Computer. This ability to share makes the use of Quadlink in the PC all the more easy. In fact, the integration of the Quadlink with the PC's I/O cards is so easy as to be practically transparent to the user.

Let's look at the commands used to access the I/O devices through the Quadlink.

Whenever you wish to change the input device to the Quadlink -- whatever is sending data in to the computer -- you must do so with an IN# statement. The IN# statement tells the computer that the input source is being changed.

The Quadlink currently supports 3 input commands. You can alter the computer input source 3 ways. The slot numbers establish the new source based on the current IBM listing device along the following lines.

### **IN#0**

IN#0 is a default input slot number. It specifies that the input to the computer comes straight from the keyboard, the usual source for input. This is the input used by the computer until it is told to do otherwise. When you have changed the input source and wish to return to the default source you must enter the IN#0 command.

### **IN#2**

IN#2 takes input from the serial port in your PC system which you have addressed as COM1. It doesn't matter what PC slot this port is installed in. This can only be changed by using IBM DOS MODE command. For information on this, see the IBM DOS manual. For example, if you wanted to receive data from a modem which you had addressed as COM1, enter the command IN#2. This would allow input from either the modem or the keyboard.

## **IN#6**

This command causes the input to temporarily come from the default disk drive, drive A. When the command IN#6 is entered the Quadlink automatically boots drive A for DOS 3.3. This is the command used when you want to install DOS 3.3 in your system to program in one of the BASIC languages or in any other language for which you have a system language card.

## **CHANGING THE OUTPUT SOURCE**

Whenever you want to change the device the computer's output is sent to, you must do so through a PR# command. This command tells the Quadlink that you are sending data out of the computer to a peripheral other than the default output. The Quadlink's default output device is the display screen. This is set up automatically when the Quadlink is activated. When the default output is changed it can be readdressed to the display screen by typing in PR#0.

### **PR#1**

Entering PR#1 sends data output to the peripheral card you have addressed in your system as LPT1. If you have a printer hooked up to your system and its interface card is addressed as LPT1 you can list a BASIC program, for example, by loading the program into memory, typing PR#1, then listing the program.

### **PR#2**

PR#2 sends data output to the interface card addressed as COM1. It works just like the PR#1 command only it sends data through COM1. To get the output back to the display screen after you have used either of the above two commands, type in PR#0.

## **PR#6**

This command works exactly like the IN#6 command. When entered it causes the computer to boot the system from drive A, looking for DOS 3.3.

## **PR# AND IN# COMMAND LIMITATIONS**

Currently PR#3, 4, 5 or 7 and IN#1, 3, 4, 5, or 7 are not supported by the Quadlink. If you specify these input/output commands you will cause the system to hang. To get out of this, you will need to initiate either a soft or hard reset.

A soft reset saves your program and takes you back to command mode. It is initiated by typing

CTRL BREAK

A hard reset CTRL-ALT-DEL is simply a reboot and causes the system RAM to be automatically cleared. This amounts to simply powering up the system again.

## **USING OTHER PC EXPANSION CARDS**

Along with the PC's input/output interface cards, the Quadlink can also take advantage of any additional RAM cards you may have installed in your system. Such RAM cards can be used as emulators that use system memory as an extra or multiple drives; or they can be used as space for a software spooler, a print buffer to let you compute data at the terminal while you re involved in a print operation.

Both these uses are possible as long as you have the necessary software to support such functions.

## **SERIAL PORT OPTIONS WITH QUADLINK**

As mentioned earlier, the commands PR#2 and IN#2 are used to direct information into or out of the serial port you have set up (in the IBM mode) as COM1:.

When you wish to configure this serial port when you are in the Quadlink mode, the following information will help you. It presents you with details on changing the baud rate, the parity, the data format, and other serial port characteristics so that you may use your Quadlink with modems, serial printers, in Time Sharing Operations, etc.

## **COMMUNICATIONS WITH QUADLINK**

The Quadlink serial driver uses the serial port (COM1:) provided on IBM and IBM-compatible cards that support asynchronous communications. Baud rate, data format, and parity can be set and changed from both PC-DOS (with the MODE command) and Quadlink. For information on changing the async port configuration under PC-DOS, see the IBM DOS manual.

## **CONFIGURING THE SERIAL PORT**

When you wish to "turn on" the COM1: serial port for configuration you must first do so by typing PR#2 or IN#2, either directly from the keyboard or as part of a line in a BASIC program.

Once this is done, the Quadlink serial driver will look for any configuration commands. It will recognize the key sequence CTRL-A (the CTRL key held down while the A key is pressed once) as the beginning of a command. If you include this command character as part of a line in a BASIC program you will need to do so by PRINTing CHR\$(1).

If you have issued an IN#2 command, typing CTRL-A directly from the keyboard will result in the message:

## QUADLINK SERIAL:

being displayed on your monitor screen. (Although no such message appears when you use PR#2, the system is still ready to accept configuration commands after you type CTRL-A.)

**Note that all commands described below must be completed with a press of the RETURN key.**

### CHANGING THE BAUD RATE

The asynchronous port you have configured as COM1: fully supports, in the Quadlink mode, the complete range of available baud rate options.

To change the baud rate of this port, you must issue the CTRL-A command character followed by a number from 0 to 7 then the letter B. The table below lists the serial port baud rates and their corresponding command number:

#### Baud Rate Designation

Baud Rate	<n>
110	0
150	1
300	2
600	3
1200	4
2400	5
4800	6
9600	7

As an example, let's say you wanted to configure COM1: for 1200 baud from within a BASIC program. To do so you would include the following line:

```
XX PRINT CHR$(1); "4B" :REM CHR$(1) IS CTRL-A  
(where XX is a line number)
```

If you wanted to do the same thing straight from the keyboard, type:

```
<CTRL-A>4B<RETURN>
```

## CHANGING THE DATA FORMAT

Often, when you are using certain modems or time sharing services with your Quadlink, specific data formats such as the number of data bits in each character (usually 7 or 8) are required.

To configure COM1: for 7 data bits per character, type:

```
<CTRL-A>7D<RETURN>
```

To change to 8 data bits, type:

```
<CTRL-A>8D<RETURN>
```

The following two BASIC lines are equal to the above keyboard commands:

```
XX PRINT CHR$(1);"7D"  
XX PRINT CHR$(1);"8D"
```

## CHANGING THE PARITY

The parity can be selected as Even, Odd, or None by the use of the following command (typed from the keyboard or included in a BASIC line):

```
<CTRL-A> <n>P<RETURN>
```

<n> is selected from the following table:

Parity	<n>
None	0
Odd	1
Even	2



## USING A SERIAL PRINTER

If you are using the Quadlink-mode serial port to send data to a serial printer you should include the command:

<CTRL-A>P

before sending data to the printer.

This command clears the high bit before sending the character out through COM1:. If the high bit is not cleared, you'll notice that the IBM graphics printer and the Epson printers print italics. This is due to the fact that, with the high bit set, the characters sent to the printers are addressing the italics character set.

NOTE: The Epson and IBM serial interface requires the following cable pin configuration:

1	1
2	3
3	2
11	5
5	4
6	20
20	6
7	7

## MAKING SURE THE HIGH ORDER BIT IS SENT

If you have used a <CTRL-A>P command and wish to return to the default state with the high order bit, you can use a <CTRL-A>H command. This causes subsequent outgoing characters to be sent without clearing the high order bit.

## SUPPRESSING COMMAND CHARACTER RECOGNITION

If it is ever necessary for you to send out a <CTRL-A> or other command characters you will need to suppress the serial driver's recognition of the command character. Do this by typing:

<CTRL-A>Z<RETURN>

Once you have done this you will have to reinitialize the serial driver with either a PR#2 or IN#2 before the driver will again recognize <CTRL-A> as a command character.

In a BASIC program the line

```
XX POKE 1530, (PEEK(1530)-128)
```

suppresses the command character recognition.

### **CHANGING THE COMMAND CHARACTER**

You can change the command character from CTRL-A to another control character by typing CTRL-A followed by the new control character. To change the command character back to CTRL-A type the new command character followed by CTRL-A.

NOTE: Do not set the new command character to CTRL-R, CTRL-S, or CTRL-T.

### **RESETTING THE SERIAL DRIVER**

To reset the serial driver type: <CTRL-A>R<RETURN>. This is equivalent to using PR#0 or IN#0 (i.e., it turns the serial driver off).

### **TRANSMITTING A BREAK**

Finally, if you wish to transmit a break — useful for ending sessions with time sharing systems — type:

```
<CTRL-A>B<RETURN>
```

NOTE: If you are using Quadram's QuadJet color ink-jet printer you can perform screen dumps in the Quadlink mode by entering in the following two line BASIC program:

```
10 PR#1  
20 PRINT CHR$(9); "C"
```

The "C" can be anywhere after "C" in the command string.

## **PRINT FORMAT COMMANDS WITH QUADLINK**

When you are operating in the Quadlink mode and wish to print information on screen or stored on disk, the following commands may be useful. They are used for print mode formatting: setting page lengths, margins, etc. They can be issued either straight from the keyboard or as lines in a FP BASIC program.

### **CTRL-InN**

This command sets the line length on a page to n characters beginning from the left edge of the page (not the left margin). After this command, characters will not appear on the screen; they will be printed only. After n characters have been printed, a carriage return occurs. If the line length is zero, the computer will not generate a carriage return until it receives one from the keyboard. NOTE: When listing BASIC programs, the printer will automatically print 40 columns unless CTRL-I80N is used.

### **CTRL-II**

This command transmits characters to both the screen and the printer. When you set the line length (above) you turn off information to the screen. Use CTRL-II to get it back again.

### **CTRL-InL**

This is used to set the left hand margin to the nth column. For example, using CTRL-I20L will cause all your printing to start at the 20th column on the page.

### **CTRL-InR**

And this command sets the right hand margin of the page. The margin is set nth column from the left edge of the page. This command prevents words from being split at the right margin when you come to the end of the line. A zero margin length disables this feature.

### **CTRL-InP**

This command sets the page length to n number of lines. After the printer prints n number of lines it will automatically perform a form feed. An n specified as zero disables this page length feature.

### **CTRL-IS**

This command performs a print screen operation. It sends whatever is on the screen to the printer which begins printing 20 spaces from the left edge of the paper. This command is accessible from FP BASIC only when it is using monitor routines.

### **CTRL-IB**

This command will turn on the printer bell, if yours has one. It will allow the key combination CTRL-G to ring the bell.

### **CTRL-IC**

Turn off the printer bell.

### **CTRL-IH**

This command allows the high-order bit (the 8th bit) to go to the printer. On some printers (such as the Epson MX-80), this allows the printing of block graphics. However, during block graphics the character set cannot be accessed. NOTE: if you own an Epson with a Graftrax Prom installed, you will print italics instead of block graphics.

### **CTRL-IX**

This prevents the high order bit from being sent to the printer. It puts the printer back in standard text mode.

### **CTRL-I CTRL-Y**

This changes the command character CTRL-I to CTRL-Y. Any control character may be used in place of Y, but characters used by the printer or normal text should be avoided.

### **CTRL-Y CTRL-I**

This changes the command character back to CTRL-I.

## GETTING DOWN TO BASIC

Along with allowing you to run prepackaged Apple software, Quadlink also lets you program in BASIC when you are in the Quadlink mode. The IBM also features a BASIC interpreter installed in its system so that you can program in BASIC in the IBM mode, too. But while each mode allows you the use of BASIC, they use slightly different forms of the language as dictated by their operating system.

For instance, the PC offers one version of BASIC called BASICA, advanced BASIC. Two versions are available with the Quadlink: Floating Point and Integer BASIC.

Integer BASIC as a language only processes integers, or whole numbers. This being the case, Integer BASIC is not as flexible as other forms of the language. Consequently, Integer BASIC is used very little. Floating Point BASIC has become more popular.

Floating Point BASIC is different from Integer BASIC in that it allows the use of a decimal point to process fractional numbers in the program structure. This characteristic makes it more versatile than Integer BASIC. It is the language you will find more helpful when you are programming in the Quadlink mode.

The IBM PC BASICA is similar to Floating Point BASIC in many ways, but as the two system modes are distinctly different so is their use of the BASICs. This final part of the DOS section will briefly highlight some of the differences between the two forms of BASIC available in your PC system with Quadlink. However, this is not intended to be a tutorial on Floating Point BASIC. For more in depth information consult the LITERATURE section of this guide for references to material on this subject matter.

## **BASICA vs FLOATING POINT BASIC**

There are a few programming characteristics for Floating Point BASIC which you will have to get used to when you switch over from PC BASICA into the Quadlink mode. Among these differences is the fact that FP BASIC gives the user full access to the DOS software installed in the Quadlink, from direct or deferred execution (from the keyboard or within a program). The latest version of PC BASICA maintains strict separation between its DOS and BASICA.

Also with FP BASIC, files and whole disks can be protected from accidental erasure through the software by use of a LOCK command. The inverse of this command is UNLOCK. No similar type of command exists in PC BASICA.

Another difference is that FP BASIC does not use an ELSE construct as part of the IF/THEN statement. This is included in the PC BASICA. BASICA also includes a WHILE/WEND construct which is missing in FP BASIC.

Both FP BASIC and PC BASICA allow for the storing of complex figures in memory. FP BASIC allows the user to create shape tables; PC BASICA uses draw strings. BASICA also has an additional set of constructs which allow monitor images to be extracted for storage in an integer array, and later replaced at will in any location on the screen, allowing various logical functions to interact between the stored pixel constants and the current state of pixel definition on the screen.

## D O S

The word DOS is an acronym for the term Disk Operating System. A disk operating system is any kind of computer set-up that uses a disk for information storage and retrieval. Though you've probably never thought of it in this term before, your Personal Computer is a disk operating system. Your Quadlink is also a DOS system.

DOS software is provided when you buy your micro-computer. It comes to you on a floppy disk called -- appropriately enough -- the DOS Disk. The DOS Disk contains all the programs necessary to enable your computer's hardware to have access to the memory space available on the disks.

Before running any programs or recording any data through the use of the computer's disk drives, you must first boot your system with the DOS Disk, you must install the DOS software into the system's RAM. Once installed, the DOS programs allows your computer to run ready-made, pre-packaged programs, create and use files, and take advantage of any peripherals you may have attached to your system.

Since the software for DOS is written exclusively for certain operating systems, DOS programs are system specific. For example, you cannot insert an IBM PC-DOS Disk into an Apple home computer and expect anything productive to happen. The PC-DOS programs were written for the "execution environment" of the Personal Computer. The Apple was designed with an entirely different "execution environment." It processes information in a distinctly different



way. The PC-DOS programs would flounder helplessly in the circuitry of the Apple, causing the Apple to send a disk error message to its user.

Of course, PC-DOS programs work great in the PC. But, if you have Quadram's Quadlink installed inside your PC, when you switch into the Quadlink mode you are switching into an "execution environment" different from that of the PC. Consequently, the Quadlink operates with its own DOS. It shares practically everything else with the PC -- the disk drives, interface cards, even the power supply -- but runs with its own set of DOS programs.

## **USING D O S**

In this chapter, we'll discuss some of the characteristics of the Quadlink's DOS programs. We'll talk a little about how the computer's disk operating system works, what new commands are needed to make it work, and what old commands are changed when DOS is at work. Let's begin with the most obvious part of the Quadlink's disk operating system: the disk, itself.

There are two kinds of disks used in microcomputers: hard and floppy. Hard disks are rigid, record-like memory devices capable of storing large amounts of information. Until recently, hard disks were used mainly in larger computers. Cost factors tended to prohibit the use of hard disks in home and personal computers. But lately, hard disks are being used more and more with these computers.

Easily the primary mass storage medium for microcomputers today is the floppy disk. The kind of floppy disk most used by microcomputers is a small plastic disk about 5¼" in diameter. It is coated with a magnetic film sensitive to electronic impulses and permanently sealed in a protective plastic envelope. The programs that operate the Quadlink's DOS are stored on a floppy disk.

The floppy disk is called "floppy" because it is flexible. But don't let this fool you. The disk was never meant to be bent or roughly handled. In fact, it is a very delicate piece of material and should be carefully protected.

What you are protecting when you take good care of a disk is not the actual disk. The disk is really pretty sturdy. You can sail it through the air like a frisbee; you can drop it into an aquarium; you can set your monitor on it, and when you find it hours later it will look fairly well intact. What you will have destroyed is not the disk, but the information contained on the disk.

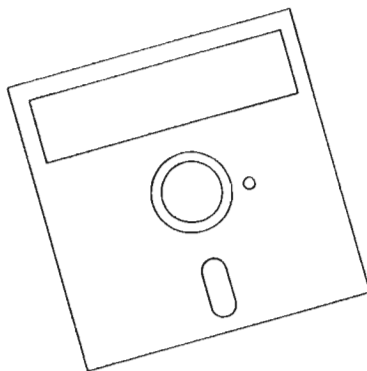
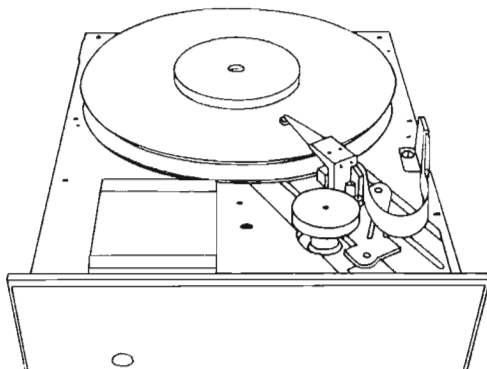

*A hard disk (top) and A floppy disk (bottom)*

The floppy disk is so delicate because it stores information electromagnetically as impulses on its surface. These impulses can be easily disrupted if the disk is ever roughly handled. Therefore, care should always be taken to make sure the disk is properly treated.

Here are a few general rules concerning the care of floppy disks:

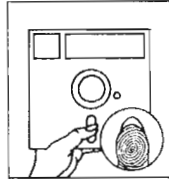

1) Never touch the exposed portion of the disk or subject the disk to dirt, grease, or grime. Any foreign material that comes in contact with the disk surface may destroy pieces of disk information.

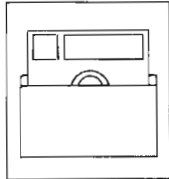

2) Never leave a floppy disk lying around uncovered. When not in use, a disk should be stored in a disk jacket, a special envelope that keeps out excess dust and cuts down on static electricity.



3) Static electricity and other electronic fields can harm the magnetic properties of floppy disks. So never bring a disk into contact with magnets or any other device that puts out these fields (such as color television sets).

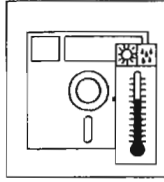

4) Never expose a floppy disk to direct sunlight or extreme temperatures, hot or cold. Prolonged exposure to temperatures over 125 degrees F or under 32 degrees F will ruin a disk.

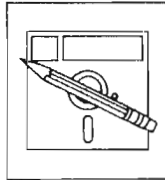

5) Finally, when labeling a floppy disk with the names of the programs recorded on it, make sure you write on the label before sticking the label to the disk. Writing on the disk is very likely to destroy some information. If you must write on the label when it is already on the disk -- such as when you update your file information -- use a soft felt tip pen and press very lightly.

If you treat a disk right it should give you about 50 good hours of use. But if you throw it around carelessly, leave it out of its jacket, or generally show it little respect, the disk will crash on you the first chance it gets.

The above rules help guard against the careless destruction of your floppy disks and all the information contained on them. But as there is more than one way to skin a cat, there is more than one way to destroy disk information. One of the most common is accidentally erasing the information during your computing work, or accidentally writing over information on the disk.

The way to guard against this is to write-protect the disks whose information should never be erased or written over. Write protecting a disk is easy to do.

If you look closely at the floppy disk, you'll notice a small square notch cut out of one of the sides. This notch allows the computer to write data to the disk. When you don't want data written to the disk, all you must do is to cover this cut-out up with a small piece of tape. With the notch covered, every time you try to erase or write data to the disk, you will get a WRITE PROTECTED error message reminding you that the disk is write-protected.

## THE DISK DRIVE

The part of your computer system that reads information off and writes information to a disk is called the disk drive.

The disk drive is the most mechanical part of the system. It is the only device installed in the computer that works through moving parts. Everything else is done by conducting electricity through intricately mapped circuit paths. The part of the drive that moves is called the drive head. The drive head reads a floppy disk in the same way that the stylus on the tone arm of a record player reads a record. The head is lowered onto the disk when the drive door is closed. When the computer is in need of certain information, the drive head moves across the disk, searching for the specific track and sector on the disk where that information is stored.

When you insert a disk into the drive, do so with the exposed portion of the disk entering first in such a way that the write-protect notch is found on the left edge of the disk. Slide the disk in gently until it is in the drive all the way. Then close the drive door.

Just under the drive slot on the PC there is a red LED that lights to signal when the drive is in operation, that shows when the disk is spinning and head is searching the

disk for information or writing information onto the disk for later use. When this red light is on, never open the drive door and remove the disk. Doing so could not only ruin the disk, it could permanently damage the drive, too.

## **BOOTING DOS**

For your disk operating system to work, for it to operate with disks, the DOS commands must be installed into the computer's memory

The Quadlink's DOS disk is The Filer disk. (The Quadlink uses the same DOS software as the popular Apple II and II plus computers.) Take it out now. Let's go through the steps of "booting the system with DOS."

Before we can boot DOS, though, the PC must be powered-up and booted with the Quadlink System Master Disk or the PC DOS disk with the Quadlink boot program on it. With this condition met, booting DOS is a snap.

Put the DOS Disk in drive A, get into the pre-Quadlink mode with CTRL-ALT-A, and type:

CTRL-ALT-DEL  
(All at the same time)

Remember, after every DOS command make sure you press the ENTER key. This executes the command.

After you press CTRL-ALT-DEL, the red "ON" light on the disk drive will come on and the disk will start spinning in the drive. After a few seconds of this, a message will come up on the display screen telling you that DOS has been installed. The message will look something like this:

THE FILER UTILITY DISK  
©1982 CENTRAL POINT  
SOFTWARE

And that's all there is to it! With DOS properly installed in your system's RAM, your computer is now free to use all its disk drives and peripheral interfaces (such as serial and parallel ports). At this stage, you will want to make sure you have a supply of disks ready to use with your system.

The preprogrammed software packages that the Quadlink lets you run are all written for the kind of execution environment used by the Apple. In addition to their application programs, these disks contain certain important software commands that allow DOS to control the use of these programs. These disks can be run in your system as soon as DOS is booted.

The new disks you buy blank from your computer retailer, however, are not equipped with these important software commands. Consequently, before you can use a new disk in your system, you must first prepare it for use with DOS. In the IBM mode, this preparation is called "formatting" a disk. In the Quadlink mode, it is called "initializing" a disk. All blank disks that you wish to use with the Quadlink must first be initialized.

## **INITIALIZING A NEW DISK**

To initialize a blank disk, use the initialize command, INIT, along with a simple BASIC program called the LINK program. This program should contain some information about what data you plan to store on the disk, when it was

created, and what it will be used for. Since the LINK program is automatically run whenever the disk is booted, such information will help you know just what disk you're using.

The following is a typical LINK program.

```
10 REM LINK PROGRAM
20 PRINT "CECILIA'S DATE BOOK: 1983"
30 PRINT "PHONE NUMBERS AND ADDRESSES"
40 END
```

You can add in any information you like in a LINK program. You might code the program so you'll know if it was written in floating point or integer BASIC. You might want to write the program in Croatian for privacy's sake. You can do anything you like. The only guideline to follow is to make sure that the LINK program helps you quickly realize what's on the disk.

Let's go step by step and initialize a new disk right now.

Step 1: With the Quadlink activated and on-line, boot the system with your DOS 3.3 disk.

Step 2: Once DOS has been installed, remove the DOS disk from the drive and put in a new blank disk. Close the door and type

NEW

Step 3: When you see the ready prompt on the display screen, type in your LINK program. To get you off to a good start, let's use this one:



```
10 REM LINK PROGRAM
20 PRINT "A READY-TO-GO DISK"
30 PRINT "INITIALIZED 7/31/83"
40 END
```

Step 4: Once you have entered in the program and you're happy with what it says, type

```
INIT LINK <ENTER>
```

When you press the enter key, the disk drive's red "On" light will come on and the disk will immediately begin to spin, making occasional whirring and clacking noises. You'll have to be a little patient here. This will continue for about thirty seconds as the drive head initializes all the sectors and tracks on the disk.

When the red light goes out, remove your newly initialized disk and label it. You might have prepared the label during the time the disk was in the drive so all you have to do now is peel it off and gently apply it to the disk. Since all disks look alike, you may want to code the labels of your Quadlink disks so you won't confuse them with your IBM disks. Unless you want to store them separately, there is really no other way to tell the disks apart.

Now let's make sure everything went well, let's see if the disk was properly initialized. Put the disk back into the drive and reboot the system. What ought to happen is that in just a few seconds the video screen displays the PRINT statements of your LINK program.

For example, if you used the LINK program provided in this guide, you would read on the screen:

```
A READY-TO-GO DISK
INITIALIZED 7-31 83
```

You can now use this disk to boot the system, so put the DOS 3.3 original disk away in a safe place. You will want to protect this master disk from the harsh realities of computer use for as long as possible. You should take it out of hiding only when you wish to make additional copies of its programs.

## **DOS COMMANDS**

The use of DOS with BASIC requires you to learn a few new commands and to relearn a few old BASIC commands that now take on new dimensions. Since the purpose of a disk is to provide the computer with an information storage and retrieval medium, the first DOS command you will want to learn is how to save program data to a disk.

### **SAVE**

Whenever you write a program, or compute information in any way on your computer, the computer stores the information in its system RAM, random access memory. The problem with storing information here is that system RAM is volatile memory. This means all information stored in system RAM will be lost when the computer is turned off.

The storage space on a disk is also RAM, but it is non-volatile. Data stored here will not be lost when the computer is turned off. Information on a disk can be kept there permanently until the disk is erased or destroyed.

The SAVE command in DOS allows you to save a program in your computer onto a disk. Let's run through a quick example that demonstrates how the SAVE command works.

First boot your system with your newly initialized disk and get into one of the BASIC formats (type FP <ENTER> or INT <ENTER>). Because booting the system with this disk automatically installs the LINK program in system memory, the first thing you should type after you see the BASIC prompt is:

```
NEW
```

This erases all program data from system memory. Now let's create a simple BASIC program that we want to save. Type in

```
10 REM ADDITION PROGRAM
20 LET A=1
30 LET B=5
40 LET X=A+B
50 PRINT "THE SUM EQUALS", X
60 END
```

Now run the program. The result should appear on the screen as:

```
THE SUM EQUALS 6
```

Okay? Does the program run the way you expected? Are you happy with it just like it is? Good. Let's save it now.

In DOS, the SAVE command is used along with the name of the program you wish to save. Let's call the above program Addition, as in the line 10 Remark statement.

Simply type in:

```
SAVE ADDITION
```

After you press the ENTER key the disk drive will activate and the disk will start spinning as the drive head copies

the program from system RAM to the disk. The SAVE command has been executed and completed when the drive's "On" light goes off. In theory, the program to add 1 to 5 now resides on the disk under the file name Addition.

No doubt, you want to make sure this theory checks out. To get a program off a disk and back into system memory, we must use another command, the LOAD command.

## **LOAD**

The LOAD command is the functional opposite of the SAVE command. In DOS, LOAD causes the drive head to copy a file off a disk into system RAM. This command does not put your program data up on the display screen, though. Like putting bullets into a target pistol, it is merely a preparatory action. Let's load the Addition program from disk.

Type in

```
LOAD ADDITION <ENTER>
```

NOTE: After each DOS command always make sure to press the ENTER key. From this point on, we will omit this detail from our examples.

The disk will now begin to whirr as the program is loaded into the system's memory. When the disk stops, type in:

```
LIST
```

Almost magically, the Addition program comes up intact on the screen just as you first entered it. Amazing! And if you run the program, the screen will display

all over again. Aren't floppy disks wonderful!

## **NAMING FILES**

When you save information to a floppy disk you do so by giving the information a file name. This file name gives the computer a specific location on the disk where it can find the information at a later date. You are free to give a program almost any file name you wish. There are, however, a few limitations that you should be aware of.

First, you cannot give a file a name longer than 30 characters, spaces and punctuation included. So a name like A Simply Wonderful Way to Add 5 to 1 would not work well as a file name. DOS would cut the name off at the 30th character. When you were searching through the disk catalog for this particular program it would appear to have vanished. All you would find is a file named A Simply Wonderful Way to Add.

"Did I ever enter a file named that?" you might wonder.

So, for clarity's sake, it is advisable to keep all file names under the 30 character cut-off point.

Also, you cannot begin a file name with a number. Names such as 23-Skidoo won't compute. Twenty-three-Skidoo will compute. You cannot use commas anywhere in a file name, either. The name "Pat, Tim, and Margaret" would be unacceptable.

One note of caution here: you can use control characters when naming your files, but using these characters is like writing the names in invisible ink. The control characters will not show up on the screen when you display a catalog of all the file names. If you named a file S<T>O<P> it would be displayed in the catalog as SO. If you forgot you used control characters in the file name and typed in the command

LOAD SO

the computer would come back with the prompt

FILE NOT FOUND

The computer would load STOP only when you entered it with the control characters you originally used.

The following is a list of some good file names followed by a list of some unacceptable file names.

Good file names:

ADDITION  
CECILIA'S DATE BOOK  
GRAPHIC DISPLAY #34  
A\$-Z\$ (As long as you're sure what A\$-Z\$ means!)  
SQUARE ROOT TABLE

Unacceptable file names:

NUMBERS, NAMES, AND NICETIES  
20000 LEAGUES  
ROBERT LAWRENCE'S WHITE HOUSE CORRESPONDENCE  
1 to 2  
A VERY, VERY LONG PROGRAM

## CATALOG

As you collect more and more disks, you will occasionally want to review what files you have accumulated on each of your disks. To do this, boot the system with the disk you wish to review and type in the command:

### CATALOG

This command will cause a directory to be displayed on the screen listing the names of all the files on that disk. A typical catalog might look like this:

```
002 LINK  
B 023 SQUARE ROOT TABLE  
T 012 JOB DESCRIPTION #35  
A 230 POSITIVE INTEGERS
```

Besides containing the names of each of the files on the disk, the catalog also contains two other pieces of information about each file. The letter in the first column tells the Quadlink mode the file was written in; that is, the file type. For example, the T next to Job Description #35 tells a person that file was written in Text mode. The I in front of Link tells a person that file was written in Integer BASIC; A signifies an applesoft (FP) program, and B a binary file.

The three digit number after the letter indicates how many disk sectors were used to store the program. Each disk can contain up to 496 sectors of 256 bytes each. By adding up the number of sectors currently being used on a disk, a person can estimate how much storage space is left.

## **DELETE**

If you ever come across a file in your work that is old, unneeded, or unused you can delete it from your disk and reuse the storage space occupied by that file. Deleting a file is easy. All you have to do is to display the disk catalog to make sure the file you are after is really on the disk you've got in the drive.

Should you ever tell the computer to delete a file not on the disk, don't panic. Nothing terrible will happen. The computer will not rip your disk apart in a fruitless search for the nonexistent file. The computer will simply produce a

FILE NOT FOUND

error message on the display screen.

But to avoid this and save a little time, you can check for the file you want to delete by inspecting the disk catalog. When you find the file you want to delete -- let's say you're looking to erase RAM NOTES --

do this by typing:

DELETE RAM NOTES

The file is then erased off the disk.

## **RENAME**

Under some circumstances you may want to change the name of a file. This is done easily enough. Simply find the name of the file -- this time we're after SALESMEN -- decide on the name change (SALESPERSONS, of course), load the file into system memory, and type in:



## RENAME SALESMEN, SALESPERSONS

And that's all there is to renaming a file. The only thing to remember here is that you should avoid renaming a file with a name currently on the disk. This can lead to confusion when you encounter two different files with the same names but different sets of information.

## WORKING WITH MORE THAN ONE DRIVE

Those are the standard DOS commands. They work with the Apple DOS 3.3 software disk while you're using the Quadlink in your IBM PC. Got it?

The best way to really get to know these commands is to play around with them on your computer. Experiment a little bit. Create some link programs; initialize some new floppy disks. Name and rename files. Save data. Delete data. Do whatever you like. With a little practice you'll soon be able to enter DOS commands with no problem at all.

The DOS commands we have just seen allow you to operate your Quadlink with all kinds of Apple software. But in our discussion above one thing was assumed: your system has only one disk drive. If you have two or more drives in your system, the DOS commands become a little more complex -- but just complex, not harder.

With one drive, the system always knows where the disk is. So it never has a problem finding it. With two or more drives, though, the computer gets easily confused. It needs to be instructed which drive you want it to use.

To instruct it otherwise, to tell the computer to read or write data through a drive other than A, you must com-

bine the standard DOS commands with several "operating parameters." The operating parameters are nothing more than specific instructions that let the computer know what disk drive needs to be activated, what file needs to be pulled, and how it should be treated. These parameters, together with the DOS command, make up the structure of the DOS language. Taken as a whole, this structure is called the syntax.

## **SYNTAX**

The syntax of a common DOS command consists of the actual command itself and four variables which, in different circumstances, may or may not be optional. The variables that may be included in any of your DOS commands are the filename, the disk drive number, the slot number of the disk interface, and the volume number of the disk.

These variables serve one purpose: to help the computer find the information for the DOS command to act on. Since you will probably want to use these variables from time to time, let's take a closer look at what each variable specifies and how it is used.

## **FILE NAME**

The file name is the most common variable used with a DOS command. To SAVE, RUN, RENAME, DELETE, or LOAD information into the system, the file name must be specified. Since you will be using file names with practically all your disk operations, this is one option that is very seldom optional.

## **DRIVE NUMBER**

The drive number is used to access information through a drive other than the default drive, drive 1. The default drive is not created by you pointing to it and saying, "Hey, you're gonna be the default drive today. Okay?" Rather, it is created by the computer when you boot the system. The drive you use for this automatically becomes the default drive, drive A.

Whenever you want to read or write information through another drive, the drive number must be specified. In the Quadlink mode, you can use up to two disk drives in your system, so you can specify the drive number as D1 or D2.

When you designate a new drive number, though, the computer makes it the new default drive; unless you tell the computer to do otherwise, all subsequent DOS commands will be referred to this drive.

## **VOLUME NUMBER**

The volume number DOS parameter is always optional. It need never be included in the command syntax unless you so choose. The volume number is one additional way of naming a floppy disk. Therefore, before it will ever need to be used again, it is first used with the DOS command INIT. The volume number can be any integer from 1 to 254. If a volume number of 0 is ever specified the computer assigns the disk a volume number of 254 automatically. If a volume number greater than 254 is specified you will get an error message (RANGE ERROR) displayed on your terminal screen.

You will want to use the volume number parameter as a kind of combination lock for your floppy disk. When this parameter is included along with the INIT command, no new information can be recorded onto the disk until the correct volume number is entered. The volume number is not checked by the DOS unless the user includes the volume parameter in every DOS command. The use of this parameter lets you write-protect the disk in an added way.

Unless you enter the volume number every time you want to load information from the disk, the disk also becomes read-protected. Just like forgetting the numbers to open a combination lock, if you forget the volume number you will never be able to get "into" that particular disk.

But if this ever happens to you, don't fret. All is not lost. You can call up that disk catalog and the first item displayed will be the disk volume number.

Now that we know what each of these parameters does for the DOS commands, let's see how they are used in the commands.

## USING THE DOS SYNTAX

There are just three rules you need to remember when applying these command parameters. First, the file name must always be specified first. After that, the remaining parameters may come in any sequence you wish. Secondly, each parameter must be separated from the next by a comma. Thirdly, the volume and disk drive numbers must be preceded by an upper-case V and D. Let's go through two brief examples.

**Example 1:** The PC has been booted, you are in the Quadlink mode, and you wish to initialize a floppy disk in drive 2. You have written a good LINK program and want to give the disk a volume number of 200. To initialize the disk you type in:

```
INIT LINK, D2, V200
```

**Example 2:** You boot the Quadlink with your initialized disk from above and wish to run the program SALESPERSONS from the disk in drive 1. You type:

```
RUN SALESPERSONS, V200, D1
```

## LOCK

There are a few more things DOS can do for you when you're working in the Quadlink mode. The first one we'll discuss is similar in use to the volume number parameter mentioned earlier. It is a DOS command called LOCK. Instead of working like a combination lock with a number code to "open" a disk, LOCK works like a pad lock and is used to protect individual files.

When you use the LOCK command, it will prevent the indicated file from ever being accidentally erased or written over. Let's suppose you wanted to save the file CECI'S DATE BOOK for posterity's sake. To preserve the file in its present condition you need only load the system with that particular disk, then type in the command:

```
LOCK CECI'S DATE BOOK
```

But if the memories you've preserved begin to sour after a while, if Ceci's Date Book only reminds you of all the jerks Ceci dated, you can take the file out of its "bronzed-shoe" state by typing in:

```
UNLOCK CECI'S DATE BOOK
```

Now you can erase the file or change it any way you want. It's that easy.

You can tell whether or not a file has been locked by calling up the disk catalog. A locked file is always followed by an asterisk (\*). Once a file is locked you cannot RENAME, DELETE, or SAVE other information to it. If you make such an attempt you will receive an error message from the Quadlink that says:

```
FILE LOCKED
```

## VERIFY

Sometimes you may suspect something is amiss with one of your files. Perhaps when you try to print it you get a page full of weird hieroglyphics, or when you try to access certain segments of the program for use with another one of your files, none of your commands seem to work. If this ever happens, you will want to make sure your file is not sick. To make this check, use the VERIFY command.

VERIFY searches through your file to make sure the data is readable. If it is the display screen will give you the usual prompt for the language you are in. This means everything checked out and your problem lies elsewhere. But if a dust speck ruined some data bytes or your file was subjected to static electricity (you may have left the disk on your TV set), the VERIFY command will report:

I/O ERROR

This confirms your fear that the problem lies in your data file. Unfortunately, VERIFY only tells you what the problem is. It can do nothing to help you solve it. Usually, with data bytes destroyed the information they contained is lost for good. The only way to rectify the situation is to reenter the lost data.

## TURNING YOUR PC INTO A TURNKEY

So far we've looked at all sorts of ways that DOS lets us get the most out of our Quadlink computer system. Right now, let's look at a way that DOS lets us get the least out of our computer system.

Does this sound funny? It might. But in this instance getting the least out of the computer system is a good thing. It is a way to get the computer to do one often used task in a very simple and straight-forward manner. This is called making your computer a "turnkey" system. A turnkey system is like a one-trick pony. It does only one thing, but does it very well. Let's look at how a turnkey system might be used.

A charitable organization has purchased an IBM PC with a Quadlink to help keep track of all its business operations. The computer is used for many complicated tasks like payroll figuring, overhead expense tracking, etc. But it is also used for some very minor tasks, like filing correspondence and updating mailing lists. For the complicated tasks, the organization uses a computer specialist, but the simple tasks could be easily handled by one of the office clerical workers. Unfortunately the clerical workers in the office could no more program a computer than drive a bulldozer. This, then, is the ideal situation for a turnkey system.

Ideally, when the mailing list needed updating, the clerical worker could insert a disk into the system drive, turn on the system, get into the Quadlink mode (simple, so far) and presto! the computer would turn into a Mailing List Update Machine. The list comes up on the screen and the delighted clerical worker now need only type in the changes, save it with a few more keystrokes, and when she's all done flip off the system. By being so untimidat-

ing, turnkey systems can be very useful.

The turnkey is created on the floppy disk. Creating one to run with your Quadlink is a cinch. Here's how it's done.

Step 1: Load the application program that you wish the turnkey system to use into system RAM by either using a system disk or typing in the program through the keyboard (but this is the hard way!).

Step 2: With the turnkey program in RAM, put your blank disk in the drive and type:

INIT LINK

What this does is cause the computer to write a turnkey program as your disk's LINK program. When the disk stops spinning in the drive the application program is the LINK program and it will be loaded into RAM and automatically run everytime the disk is booted. With every boot, voila a turnkey system is made.



## USING THE I/O DEVICES

One of the advantages to owning Quadram's Quadlink is that you don't have to buy any peripherals for it that you already have installed in your PC. The Quadlink is designed to share all the PC's peripheral devices. Anything from parallel interface cards to print buffers to modems can be shared by both the PC and Quadlink.

Such peripherals are usually called I/O devices, or input/output devices. These are devices that either send information to or receive information from the computer. The two major I/O devices in your system are the keyboard and the monitor. However, any card installed in the PC's expansion slots can be recognized as an input or output device through the use of the IN# or PR# commands.

IN# is used to send data from an input device to the computer. PR# is used to send data from the computer to an output device (or peripheral, hence PR). The syntax for these commands is:

PR#n and IN#n

The "n" is always either 0, 1, 2, or 6. This is fixed in the configuration of the Quadlink and cannot be changed.

When you type in IN#0, input control is returned to your system's major input device, the keyboard. When you type PR#0, output control is returned to your system's major output device, the monitor.

If, when entering a IN# or PR# command, you give the n variable an invalid number, the computer will hang. To get the computer out of this state you will have to initiate a soft reset. Do this by typing in:

CTRL BREAK

For the correct use of these commands when you are including them in a BASIC program, see the following chapter on BASIC.

## **DOS ERROR MESSAGES**

One of the nice things about owning a Quadlink is, just like other personal computers, it processes information very fast. So in a very short time it can show you just how smart you are. On the other hand, in that same short span of time it can also show you how many errors you can make.

When the Quadlink runs into one of your mistakes, it immediately stops working on the program in memory and sends you an error message. There are error messages for any mode you happen to be working in. In Integer BASIC error messages appear as statements preceded by three asterisks. In floating point BASIC, error messages are preceded by a question mark. In DOS, the message is simply stated as is. It is preceded by no special prefix.

When you're working in DOS there are about fifteen of these messages which, sooner or later, you will probably run into. The error messages appear to let you know you've erred somewhere along the way and to give you some information as to where the source of the error might lie.

We've already talked about some error messages in the earlier sections of this chapter, but right now let's review them all for an explanation as to what each means.

#### DISK FULL

This statement appears whenever you attempt to write information to a disk with no more available storage space. As we mentioned earlier, a disk contains 496 sectors into which information can be saved. When these sectors are filled, no more new information can be added. Whenever you are suspicious that you might be running out of room on a disk, check the catalog to add up the used sector indicators displayed with the file names. If you suspect your program is longer than the free storage space on the disk can accommodate, save the data to another disk.

If you get the DISK FULL message after you've already attempted to SAVE data, don't panic. The complete program is still intact in system RAM. Simply change disks in the drive to one with enough available space and SAVE again.

#### END OF DATA

This error message simply tells you that there is no more information to retrieve from your text file. The message is displayed each time you tell the Quadlink to fetch information from a place in the file where there is no data. It is as if you asked the Quadlink to search through your text file of numbers one through ten and pull out the number 17. After the Quadlink got past 10 it would find nothing else and so display the END OF DATA message.

#### FILE LOCKED

This message tells you that the file you are trying to open has been previously LOCKED. When a file is locked through the DOS LOCK command, it cannot be tampered with until

you unlock it through DOS. If you want to find out which disk files are locked and which ones aren't, call up the disk catalog. In the catalog, the files that are locked will have an asterisk next to their name.

#### FILE NOT FOUND

Whenever you see this message you have tried to bring up a file that doesn't exist on the disk you've got in the activated drive. You may see this message for several reasons. Perhaps you simply typed in a file name from another disk by accident. Maybe you misspelled the name of the file when you typed it in. Maybe you forgot to add in any control characters you used when you originally named the file. And then there's always the chance you forgot the necessary syntax for accessing the file through the correct drive.

When you get a FILE NOT FOUND message displayed, check out all these possibilities for the source of the problem.

#### FILE TYPE MISMATCH

This message occurs when you try to combine a program command with a file name not consistent with that program's language. For example, you cannot combine the file name of a data file with a BASIC LOAD command. Doing so will get you a FILE TYPE MISMATCH message.

#### I/O ERROR

This message concerns the attempt to write information to or read information from a disk. Whenever this attempt fails the I/O ERROR is displayed. There are many reasons why you may get such a message. Here are a few of them: the active drive door is not properly closed or the

disk has been inserted into the drive in the wrong way. Maybe the disk has not been initialized or maybe your drive parameter has been misstated in the syntax of your DOS command.

The best thing to do is to make a few adjustments in these areas and try again.

#### LANGUAGE NOT AVAILABLE

Whenever you enter the command FP or type in LOAD or RUN at the start or end of a program, a language search is immediately begun by the Quadlink. If the correct language is not present in system RAM there then the computer looks to the default drive. If the language is not there, then the error message is displayed. If the user types in "INT" and has not loaded INTBASIC from an Apple System Master Disk this error will also occur.

The best way -- actually the only way -- to correct this situation is to make sure the necessary disk is in the right drive. If you don't have the necessary disk, then you are asking the Quadlink to do the impossible: use a language that's not there.

#### VOLUME MISMATCH

This error message occurs when you try to access a disk with a volume number other than the one you assigned. As giving a disk a volume number is one way to protect it, the VOLUME MISMATCH message tells you that you're trying to get into the wrong disk or you've specified the wrong volume number.

#### WRITE PROTECTED

This message occurs when the Quadlink attempts to store information on a disk which has been write-protected. As mentioned earlier on in this guide, a write-protected disk

has the square notch on its side covered with a write-protect tab. The covering of this notch prevents the computer from writing any information to the disk. This is a way to protect the disk from ever being accidentally written over with new data.

## **MACHINE LANGUAGE COMMANDS**

The logic of a computer is produced in the intricate mapping of its microscopic circuit paths. Such mapping is planned in the structure of the computer's binary language and the structure of this language is called Machine Language. It is the most fundamental type of program the computer can understand. It is the program that tells the computer what to do.

If you are able to program in machine language you have access to every area of the computer's memory.

Of course, before any of this binary data will do you any good, you will have to possess a sound working knowledge of the binary and hexadecimal coding systems and know how these systems relate to a computer's microprocessor.

Those of you who have no interest in bothering with the added intricacies of machine language may skip this section. It is not essential that you know the few new commands we will discuss. But for those users who might find it helpful to have an exact bit for bit, word for word copy of the data stored in any particular section of the Quadlink's memory, this section will give you several commands to help you get to this information.

The three commands we will discuss in this section perform functions very similar to three DOS commands we have already seen: LOAD, RUN, and SAVE. In fact, the commands look very like these other DOS commands, the only difference being an added "B" to the front of each command name (to indicate Binary) and a couple of extra variables in the command syntax.

Let's look at these extra variables first.

The first, the A parameter, specifies the starting address of the relevant information. This address must be expressed in decimal or hexadecimal code. When using hexadecimal, make sure that the coded number is always preceded by a \$ (dollar sign). This tells the Quadlink that you are entering hexadecimal data. The only restriction that pertains here is that the address number must be set between 0 and 65535 (\$0000 and \$FFFF). No numbers greater or less than this range (including negative forms of this range) may be used. If they are, a SYNTAX ERROR will ensue.

The other variable is the L parameter. This specifies the length, in bytes, of the relevant information you wish to pull to a disk. Because it is only possible to store 32767 bytes in a single field on a floppy disk, the valid number of bytes that can be specified in this parameter falls in the range 1 to 32767. If a 0 is ever specified, the Quadlink will generate a RANGE ERROR message. If the number specified is greater than 32767, the Quadlink will generate a RANGE ERROR message.

The machine language commands are BLOAD, BRUN, and BSAVE.

### **BLOAD**

BLOAD transfers the data of a binary file from a disk back to system memory. If the "L" parameter is issued, the DOS will not execute the command and the Active Basic will display its "Syntax error." The A parameter is optional. If the A parameter is not used, the binary file is returned to the same location in system memory from which it was saved. The syntax of the BLOAD command is: BLOAD f, A#, V#, D#, S#.

parameter is not used, the binary file is returned to the same location in system memory from which it was saved. The syntax of the BLOAD command is: BLOAD f, A#, V#, D#, S#

## **BRUN**

BRUN loads a binary file based on the presence or absence of the A parameter and then executes the machine language program contained in that file. Note: the binary file acted upon by the BRUN command should always contain a machine language program. The syntax for BRUN is: BRUN f, A#, V#, D#, S#

## **BSAVE**

BSAVE assigns a file name to a unit of binary information and stores this newly-formed file to a floppy disk. The L parameter is always used with the BSAVE command as is the A parameter. They are not optional. The syntax for BSAVE is: BSAVE f, A#, L#, V#, D#, S#.

## **A QUICK REVIEW**

As a quick review and for future reference, here is a list of all the DOS commands discussed in this chapter and their accompanying syntax.

INIT file name, V#, S#, D#

SAVE file name, V#, S#, D#

CATALOG, S#, D#

LOAD file name, V#, S#, D#

RUN file name, V#, S#, D#

RENAME file name, new name, V#, S#, D#

DELETE file name, V#, S#, D#

LOCK file name, V#, S#, D#

UNLOCK file name, V#, S#, D#



VERIFY file name, V#, S#, D#

IN#n

PR#n

BLOAD file name, A#, V#, S#, D#

BRUN file name, A#, V#, S#, D#

BSAVE file name, A#, L#, V#, S#, D#

FP, S#, D#, V#

INT

## THE FILER DISK UTILITIES

The filer disk not only contains the necessary DOS software to run the Quadlink in the PC system, but also a number of utility programs to help you use DOS in the Quadlink mode.

These utility programs are called:

- 1) The Filer Program
- 2) Fast copy
- 3) Disk test

Let's take a look at these utility programs now and see how they work and how they can help you.

The first available utility is called the filer. This program lets you manipulate data and files on disks with great ease. Commands in this program include: LOCK, UNLOCK, DELETE, COPY, and CATALOG.

## **FILER INSTRUCTIONS**

To run the Filer utility, boot up the Quadlink mode with the Filer Disk and select option number 1. Then you'll see the Filer heading, the command menu, and the current slot and drive.

You will notice that the word "CATALOG" is in inverse. This is because CATALOG is the currently selected option, which is always displayed in inverse. To select another option, either type the number listed to its left, or use the arrow keys to move the inverse field. Once you've selected the option you want, simply press the <RETURN> key and it will execute.

Throughout the Filer, pressing the <RETURN> key usually selects the current or default option, and pressing <ESCAPE> always returns you immediately to the main menu. Pressing <ESCAPE> from the main menu will exit the program.

## **SET SLOT AND DRIVE**

The slot and drive numbers displayed at the bottom of the main menu determine which disk drive Catalog, Lock, Unlock, Delete, and Change Booting Program will use. When using the Quadlink the disk slot number must always be set at 6.

To change drive numbers, move the inverse field to the "SET SLOT & DRIVE" option and press <RETURN>. A flashing cursor will appear over the slot number. To change the number, type the new number. If you want to keep the same slot number, you can either retype the number, or simply press <RETURN>. The cursor will then appear over the drive number. As with the slot number, either type a new number or press <RETURN>. (If you type an invalid number, a tone will sound and the cursor will remain in place.)

## CATALOG

The CATALOG option gives both a standard DOS catalog and the number of free and used sectors on the disk. The catalog contains the following information for each file:

1. An asterisk if the file is locked.
2. A letter representing the filetype  
(A=Floating Point BASIC, I=Integer BASIC,  
B=Binary, T=Text).
3. The number of sectors used by the file.
4. The name of the file.

## COPY DISK

After selecting the COPY DISK option, you are asked for the slot and drive numbers for both the source and destination disks. Again the slot number must be specified as 6. As with "SET SLOT & DRIVE", you can change these numbers or press <RETURN> for no change. If a single drive is being used, you will be prompted to insert the source or destination disks at the appropriate times. Press <RETURN>, and copying will begin.

COPY DISK should ONLY be used to copy standard Apple DOS 3.3 format diskettes. In particular, do not use it to copy Pascal or CP/M diskettes. (Use Fast Copy instead).

## **COPY DOS**

This option allows you to copy only the disk operating system (the first three tracks on the disk) from one disk to another. This is useful for making master disks, which load DOS into the appropriate place in memory, regardless of how much memory your Quadlink contains. (The Filer disk is a 35-track master disk. You can create your own master disks by copying the DOS from the Filer disk onto your own initialized disks.) The COPY DOS option is similar to the COPY DISK option: Simply select slot and drive numbers, insert disks, and press <RETURN>.

## **CHANGE BOOTING PROGRAM**

This option will display the program that is run whenever a disk is booted, and lets you change DOS to boot with another program. The new program can be either a Basic or binary program or an Exec file.

When selected, the disk whirrs and the message

THE DISK NOW BOOTS WITH FILE:

appears with the name of the booting program, and you are asked for a new filename. If you press <RETURN>, the program will simply return to the main menu without changing the booting program. If you enter a filename, the program will verify that the file is on the disk, determine its filetype, and modify DOS so that the disk will subsequently boot with this new program. You are then returned to the main menu.

## FILE OPTIONS

The four remaining options deal with individual files. When asked for a filename, pressing <RETURN> will return you directly to the main menu. To manipulate one or more files, you can enter a single filename or you can select a number of files at once using a special character called a wildcard character. The Filer uses "=" (an equals sign) as a wildcard character. This character lets you match any number of characters in the filename, as long as the rest of the name is identical.

For example, if you enter a filename of "H=I", the Filer will match it with any file on the disk that begins with an "H" and ends with an "I", including "HAWAII", "HUGE MARTINI", or simply "HI". Entering a filename of "=A=" matches any file that contains the letter "A". Entering "=" matches every file on the disk.

If you enter a filename containing the wildcard character, the Filer will ask:

DO YOU WANT PROMPTING (Y/N)?

If you answer with a "Y" for yes, then for every matching file found, the filename will be displayed and you will be asked ("Y/N") whether or not you want to use this file. This protects you from accidentally disturbing files you didn't intend to change. If you answer no to the prompting question, then all matching files will be used. After all files have been operated on, the message "DONE" will appear; if no files match, "NO FILES SELECTED" will be displayed.

The current file being used is displayed whether or not prompting is selected, and files already operated on are shown at the bottom of the screen. When finished, you are again prompted for a filename. You can enter another filename or press <RETURN> to return to the main menu.

## **LOCK FILES**

This option allows you to lock one or more files at a time. If you enter a single filename, that file will be locked. If you enter a filename containing the wildcard character, only files that are currently unlocked will be matched and then locked. Hence if you select to lock files that are already locked, you will get a "NO FILES SELECTED" message.

## **UNLOCK FILES**

This option lets you unlock one or more files at a time. If you enter a single filename, that file will be unlocked. If you enter a filename containing the wildcard character, only files that are currently locked will be selected and unlocked. Hence, if you select to unlock files that are already unlocked, you will get a "NO FILES SELECTED" message.

## **DELETE FILES**

This option lets you delete one or more files. The files must be unlocked before they can be deleted. If you enter a single filename, that file will be deleted if it is unlocked. If you enter a filename containing the wildcard character, only files that are unlocked will be deleted. Hence, if you select to delete files that are locked, you will get a "NO FILES SELECTED" message.

## COPY FILES

This option lets you copy any number of files from one disk to another. You are first prompted for source and destination slot and drive numbers. If these do not need to be changed, simply press <RETURN> four times to "walk" through. If you are using only one drive, you will be prompted to insert the source and destination disks at the appropriate times. Enter the filename, and copying will begin.

If a file with the same filename already exists on the destination disk, the filename will be displayed with the message "EXISTS", or if the file is also locked, the message "IS LOCKED". You are then prompted:

<CR> TO COPY, <CTRL-C><CR> TO CANCEL, OR COPY AS?

If you respond by entering <RETURN>, the old file will be deleted and the new file will be copied onto the disk. If you press <CTRL-C><RETURN>, the file will not be copied. If you want to copy the file with a new name, enter the new name, then press <RETURN>. The Filer will determine if this new filename is also on the destination disk. If it is, you will again be prompted to accept, cancel, or change the filename.

## FAST COPY INSTRUCTIONS

FAST COPY is a program designed to copy standard disks quickly and reliably. Backup copies can be made of DOS 3.3, Pascal, and CP/M format disks. Copying with two drives takes less than 40 seconds.

To use FAST COPY, boot the Filer disk and select the Fast Copy option (option 2).

In a few moments the program heading will appear on the screen. The program will ask for information on slot and drive numbers, etc. By each prompt is a default value displayed in inverse. You can either change the value by entering a new number, or accept the default value simply by pressing <RETURN>. As always, with the Quadlink the slot number is 6.

If you make a mistake, pressing <ESCAPE> at any time will restart the program, allowing you to reenter the values. Pressing <ESCAPE> followed by "Q" will cleanly exit the program.

**ORIGINAL SLOT**      Enter the slot number (6) of the drive you want to copy FROM.

**ORIGINAL DRIVE**      Enter the drive number of the disk you want to copy FROM, or press <RETURN> to accept the drive number listed. (Range is 1 or 2.)

**DUPLICATE SLOT**      Enter the slot number (6) of the disk drive you want to copy TO.

**DUPLICATE DRIVE**      Enter the drive number of the disk you want to copy TO, or press <RETURN> to accept the drive number listed. (Range is 1 or 2.)



**ENTER START TRACK**

You may select a range of tracks on the disk to copy. This enables you to fix bad tracks on a disk, copy only the disk operating system, etc. Normally, you want to copy the entire disk, so press <RETURN> to accept track 0 as the starting track. Note that track start and end are specified as hexadecimal numbers.

**ENTER END TRACK**

As above, you may specify the last track you wish to copy. This is usually \$22, but can also be used to fix a defective track or range of tracks on a diskette.

**ERASE DOS (Y OR N)**

If you enter "N" here or take the default, the program will copy three tracks at a time. If you enter "Y", five tracks will be copied at a time, producing a faster copy, but DOS will be erased and you will need to reboot after leaving the program before you can access the disk.

You are then prompted to insert the diskettes to be copied. (Pressing <ESCAPE> will restart the program, and pressing "Q" will quit.) Insert the disks and press <RETURN> to begin copying.

When copying is finished, pressing <RETURN> will restart the program for copying another disk. To quit the program from here, press <RETURN>, then "Q".

Unlike most copy programs, FAST COPY does not stop copying if it encounters an error. This means that disks with one or two bad sectors can still be copied, with most of the data intact.

Since FAST COPY uses default values which are selected by simply pressing <RETURN>, most copying can be started quickly just by pressing <RETURN> a few times.

## **DISK TEST AND DISK SPEED**

The DISK TEST is a comprehensive utility which allows the user to perform a thorough checkout of his disk drives and diskettes. Together with DISK SPEED it forms a very useful tool for determining the cause of a disk drive related problem.

DISK TEST can be used for two distinct purposes -- to test a disk drive or to test a diskette. Testing the disk drive consists of checking the write-protect circuitry, the drive's ability to read and write, and using DISK SPEED, the rotational speed of the drive. Testing a diskette involves either checking the physical structure of the diskette (certifying), or the integrity of the data on the diskette (verifying). Checking the physical diskette consists of writing data to it and then verifying for correct data upon readback. Checking the integrity of the data on the diskettes is what is done during a Bad Sector Scan. This is a read-only test, wherein every sector of every track is checked for proper readback.

The DISK SPEED program is used to measure the rotational speed of your disk drive.

Disk speed is a very important parameter which can affect the drive's ability to boot, read, and write. You should check your drive's speed after every 25 hours of usage, as it has a tendency to change with use.

The DISK SPEED program will ask you for the slot number (still always 6) and drive number of the drive you wish to check. BEFORE entering the slot and drive number, you should insert a SCRATCH diskette into the drive. This program WRITES on the diskette, so don't use a diskette which contains any valuable information.

After you enter the slot and drive numbers, the program will turn on the drive and display the speed. The speed is displayed in milliseconds (ms); 200.00 is the nominal reading. The display may fluctuate by about 1 ms -- this is perfectly normal. The acceptable speed range is from 198.00 ms to 202.00 ms. If the reading is within this range, then the disk speed is correct.

A drive which has trouble writing or reading may not display a meaningful number for the speed. It may display no numbers at all, or it may display a series of highly fluctuating, almost random numbers. In either case, there is something wrong with the drive beyond a speed problem.

## The Selection Menu

### SELECTION 1      SELECT NUMBER OF TRACKS

Allows the user to set the number of tracks to test in the Write/Read test and the Bad Sector Scan. The allowable numbers are 35 and 40.

### SELECTION 2      CHECK WRITE-PROTECT

Displays the write-protect status of the drive under test. With no diskette or an unprotected diskette in the drive, the display should read NOT PROTECTED. With a diskette half-way inserted, or with a protected diskette, the display should read PROTECTED.

### SELECTION 3      PERFORM WRITE/READ TEST

```
*****
*                                     *
*                WARNING              *
*                                     *
*   THIS TEST WILL DESTROY ALL        *
*   INFORMATION ON THE DISKETTE      *
*   IN THE DRIVE UNDER TEST         *
*                                     *
*                                     *
*                                     *
*                                     *
*****
```

The Write/Read test first formats the diskette in the drive under test. It then writes a random pattern in each sector of each track. Lastly, it reads each sector of each track repeatedly. Press ESC to return on the menu.

**SELECTION 4**      PERFORM BAD SECTOR SCAN

The Bad Sector Scan reads every sector of every track on the diskette, repeatedly. Press ESC to return to the menu.

**Note:** The diskette being read must be a standard DOS format diskette.

**SELECTION 5**      SELECT NEW SLOT AND DRIVE

Allows the user to specify a new slot and drive for the drive under test. Allowable slot number is only 6; allowable drive numbers are 1 and 2.

**SELECTION 6**      DISK SPEED TEST

Indicates speed of the disk drive.

**SELECTION 7**      EXITS TO BASIC

Exits DISK TEST program and returns to BASIC.

**Note:** This is the proper way to exit the disk test program, as it "UNMODIFIES" DOS prior to exiting.

**Errors**

Errors can occur in the Write/Read test or in the Bad Sector Scan. There are three types of errors:

**FORMAT  
ERROR**

Occurs in Write/Read test only.  
Indicates that drive is unable to write  
or read. This is a fatal error and the  
test cannot be continued.

**WRITE ERROR**

Occurs in Write/Read test only.  
Indicates that drive is unable to write  
or read a particular sector, but test can  
continue.

**READ ERROR**

Indicates that drive is unable to read a  
particular sector.

The WRITE and READ errors will indicate which sector of  
which track was in error. For example,

READ ERROR - TRACK 5, SECTOR 4

means that the drive was unable to READ sector 4 or  
Track 5.

## HOW TO USE DISK TEST

### 1. Testing a Drive

- (a) Select the number of tracks to test.
- (b) Select the slot and drive numbers of the drive to test.
- (c) Check write-protect.
- (d) Run the Write/Read test.
- (e) Run the DISK SPEED program

### 2. Certifying a Diskette

- (a) Select the number of tracks to certify.
- (b) Select the slot and drive numbers of the drive which will do the certifying.
- (c) Run the Write/Read test.

### 3. Verifying a Diskette

- (a) Select the number of tracks to verify.
- (b) Select the slot and drive numbers of the drive which will do the verifying.
- (c) Run the Bad Sector Scan.

## SWAPPING TEXT AND BINARY FILES FROM IBM TO APPLE (AND VICE VERSA)

One of the really special things about owning Quadlink is that you get to use the QUADCOPY program on the FILER disk. This program lets you transfer text and binary files back and forth between Apple-formatted and IBM-formatted disks.

When you are ready to copy information on an Apple-formatted disk over to an IBM-formatted disk, or vice versa, you should insert the Filer disk into Drive A and type:

```
PR#6 <RETURN >
```

Drive A will boot the filer disk and you'll be presented with a screen menu. Selecting option 5 in the menu lets you run the Quadcopy program.

If you are working in a BASIC program and wish to perform a COPY operation insert the FILER disk in Drive A and type:

```
BRUN OBJ.QUADCOPY < RETURN >
```

When the program is run, the following menu will appear on the screen:

```
QUADCOPY  
(c) 1983 Central Point Software
```

```
COPY IBM FILE TO APPLE TEXTFILE  
COPY APPLE TEXTFILE TO IBM FILE  
COPY IBM FILE TO APPLE BINARY FILE  
COPY APPLE BINARY FILE TO IBM FILE  
QUIT
```

```
USE ARROW KEYS AND < RETURN > TO SELECT  
OPTION
```



One of the options appearing in the menu above will be displayed in INVERSE. You can use the NUM LOCK key and the back-arrow key (next to NUM LOCK) until the desired option is in inverse. This done, press the return key.

If you're copying IBM to Apple, you'll be prompted:

IBM DRIVE A: OR B:?

Type the letter of the drive you want to insert the IBM disk in. Then you'll see:

IBM FILENAME: \_\_\_\_\_

Type in the filename you want to copy and press RETURN.

Similar questions are asked for the Apple side:

APPLE DRIVE #1 OR #2?

APPLE FILENAME:  
\_\_\_\_\_

If you're copying Apple to IBM, the Apple questions are asked first. If, in working this program, you wish to return to the main menu, simply press the escape key.

After answering the above questions, you'll be prompted to insert both data disks if you selected a two-drive copy (for example, IBM DRIVE A: and APPLE DRIVE #2), or to insert the Source disk if a one-drive copy was selected (such as, APPLE DRIVE #1 and IBM DRIVE A:). Pressing the RETURN key will cause the copying to begin.

NOTE: Remember, when copies are made to and from Apple binary files, the bytes are simply transferred without change. If an IBM file is longer than the maximum Apple binary file length (32,767 bytes) then only the first 32,767 bytes are transferred.

When an Apple textfile is copied to an IBM file, the high bit of each byte is cleared, and CTRL-Js (linefeeds) are inserted after every carriage return for compatibility with the usual IBM textfile format.

When an IBM file is copied to an Apple textfile, the high bits are inverted again, and any linefeed that immediately follows carriage returns are stripped out (since most Apple textfiles do not include linefeeds). In addition, any tab characters (CTRL-Is) in the IBM file are expanded out to correct number spaces in the Apple file so that columns will still line up.

### WORKING THROUGH PROBLEMS

When you have a problem using the Quadlink in your system, you'll know it. You won't be able to process information, or the information you try to process will come out jumbled. Sometimes the problem will be caused by "operator error." This means you told the computer to do something it wasn't capable of doing. Maybe you entered in an improper DOS command or accidentally pressed some wrong keys on the keyboard. When operator error is the cause of the problem the computer will let you know right away. It will send you an error message on the screen. This error message will tell you the nature of the problem so that you may correct it.

Other times, however, operator error will not be the cause of the problem. For some reason the Quadlink will not work properly even though you're sure you've not told it to do something out of its range. When this happens, tracking down the problem can be difficult, especially since an error message will not usually come up on the screen.

Fortunately, problems of this nature are almost always somehow associated with either an unfamiliarity with the system or an improper installation set-up. Only rarely is the problem integral to the circuitry of the board.

Most often, though, the problem will not be this serious.

Now let's look at some possible problems you might run into and the different ways the problem might be solved. (If -- try as you might -- you cannot track down a particular problem and you're getting more and more frustrated, contact your local authorized Quadram computer retailer for assistance. Usually he'll be able to provide you with the technical expertise needed to get your system up and running smoothly. If your dealer cannot help you contact Quadram's technical support specialists at 404-923-6666. They will be happy to provide you with any assistance you might need, from consultation to factory repair or servicing.)

## **IF YOU ARE EXPERIENCING VIDEO DIFFICULTIES . . .**

Your monitor is where many of problems might pop up. Not only might you receive some error messages on the screen from time to time, but sometimes you might not see anything on the screen, maybe just whiteness, or you might see strange characters and shapes appear. When such problems occur unexpectedly, you will want to check everything that deals with your screen image. This includes the monitor itself, the video display cables, the video display card, and the Quadlink itself.

**NOTE:** Whenever you are performing such a system check it may be necessary to inspect the inside of the PC. If this is the case, before opening the PC chassis turn off all power and disconnect the power cords from the system. Working on the PC system board or on any option cards installed on the board with the power on could result in damage to the system board, the option card, or you!

When you are checking the source of the video problem, ask yourself these questions:

Was the Quadlink properly installed in the expansion slot? if not -- if it hasn't been correctly linked to the PC system -- then any video information channeled through it would become jumbled or lost.

Did you remember to plug the video display card back into the system after you removed it to install the Quadlink? This may seem like a silly thing to check, but often the worst problems are due to the easiest oversights.

Has the Quadlink's nine pin sub mini D-type connector cable been properly connected to the video card and the Quadlink. Are you using the lower nine-pin connector on the Quadlink?

Have you connected the Quadlink to the monitor and the monitor back into its power source?

If you see strange images on your monitor screen you should ask yourself if you're trying to do something in the Quadlink mode, like high-res graphics, that you expect to look like the IBM mode.

Also, sometimes when you first switch into the Quadlink mode, the screen display may lose some of its horizontal hold. A quick adjustment of the H-hold knob will correct this.

## PROBLEMS USING DOS

Another common problem area will be the use of DOS. Since you will be operating with two different disk operating systems, it may be easy to make a few mistakes or run into a few tie-ups. This will almost always evidence itself in a problem with either the disk or the disk drives. If you experience problems in this area ask yourself:

Have you activated the Quadlink? If you try to use Apple software in the PC system without activating the Quadlink the drives will report a nonsystem disk error or the computer will hang, causing you to reset the system.

Have you installed the DOS software? Without the Filer installed into system RAM the disks will not work in the computer.

Are you playing a compatible program for the specific mode you are in? An IBM disk will not work in the drives when you are in the Quadlink mode. Check to make sure you are playing compatible disks for each of the modes you work in.

Are you using the correct DOS commands for the mode you are in? Some of the IBM PC-DOS commands will not work in the Quadlink mode; and some of the Apple DOS 3.3 commands off the Filer disk will not work in the IBM mode. Check this.

Is the disk controller cable properly attached to the connector on the Quadlink? Have you remembered to install the disk controller card in expansion slot #5 and has it been properly connected to the Quadlink? If there is a problem here the disk drives will fail to operate in either mode.

## **IF YOU ARE EXPERIENCING AUDIO DIFFICULTIES . . .**

Check the manner in which you rerouted the speaker wire through the Quadlink.

## **INPUT/OUTPUT PROBLEMS**

If for some reason you cannot either change your input source from the keyboard or cannot send data out through one of your installed I/O cards, ask yourself the following:

Are you using the correct commands for input and output for the mode you are in? For example, booting a disk in drive A with the Quadlink's PR#6 command means nothing to the computer if you are in the IBM mode.

Are you sure that you have the correct I/O cards installed in the system for the operation you are specifying. If you set-up the system program just right, and use all the right commands, but don't have the interface cards to support the commands, nothing will happen. So make sure you have a peripheral device for every peripheral operation you wish to undertake.

Are you trying to do something you haven't specified in the IBM mode program? Go back and check this program. Perhaps you are trying to send information out through an interface labeled LPT1 which is set-up for COM1.

If your system hangs, perhaps you have used the wrong PR# or IN# command. If this is the case, you should perform a soft reset on the system by pressing the keys

CTRL BREAK

or you can initiate a hard reset with

CTRL ALT DEL

This will cause the system to boot drive A for Apple DOS 3.3

Many times, the problems will clear up the more you practice with the Quadlink in your IBM PC.

**FOR YOUR REVIEW. . .  
A SAMPLE WORK SESSION WITH THE PC  
AND THE QUADLINK**

Okay. The Quadlink is installed in your IBM PC. It's on your desk ready to go to work for you. First let's look at how to turn it on. First, get out your working disks: the IBM DOS disk and the Filer disk.

Put the IBM PC-DOS disk with the Quadlink boot program installed on it as an AUTOEXEC.BAT file in drive A.

Turn on the power to the PC.

The power on, the disk in A will spin and boot and you'll get into the IBM DOS mode with an A > prompt showing and instructions to insert the FILER disk.



Take out the IBM DOS disk and put the Filer disk in drive A.

Then press any key. The drive will load the Apple DOS. Here press CTRL-ALT-A, then press CTRL-ALT-DEL.

The checkerboard pattern will vanish as you go into the Quadlink mode seeing the Filer copyright notice. Now press ESC and you'll be ready to go.

Now that your system is set up and ready you are free to work in either the IBM mode or the Quadlink mode. Since you are already in the Quadlink mode you may want to work on an addition program using floating point BASIC.

Seeing the prompt, you would type in: FP <RETURN>

With the FP prompt you would enter in your program:

```
10 REM ADDITION
20 LET A=1
30 LET B=2
40 LET X=A+B
50 END
60 RUN
```

Then while this program ran you could press the keys

CTRL ALT I

and go back into the IBM mode, where you would see the A> still waiting for you.

At this point you could put the IBM DOS 1.10 disk back in drive A and type:

BASICA<RETURN>

This will take you into IBM BASIC and you can compute here awhile. When you tire of this you might want to go back and check out the Quadlink program.

Then you would type:

CTRL ALT A

And you would be back in the Quadlink mode looking at the result of the program you ran.

Now, if you wanted to, you could put an Apple II plus accounting spreadsheet package in drive A and type:

PR#6

The spreadsheet program would run and you could then process your financial data through this package. Once you had completely entered all the information you needed you could have the program analyze the data. While it was doing this you could enter:

## CTRL ALT I

and get back into the IBM mode. If you had left BASICA having just entered in a program line you would taken back to that point.

You could work in the program for a while until you thought your accounting results would be ready. You could get out of BASICA by typing SYSTEM then you could press

## CTRL-ALT-A

You would then see your accounting results ready.

Seeing enough of that you could do a soft reset by pressing

## CTRL BREAK

Now you could put a game package in Drive A after all this work and type in

## PR#6

The game would boot, and you'd be ready to relax for awhile.

This sample work session is designed merely to get you familiar with having two modes to work in. As stated earlier in this manual, the best way to really get to know the Quadlink is to practice.

## AFTERWORD

With the purchase of Quadram's Quadlink, a whole new world of software has opened up to you. You can take advantage of literally thousands upon thousands of software packages which, until now, were not compatible with the IBM Personal Computer. These software packages include programs from all three major software divisions: educational, business, and entertainment. Anything from Algebra 1 to Accounting Spreadsheet to Space Invaders -- and all now PC compatible. And that means no more barriers for you. That means you can take full advantage of owning a Personal Computer. It means now more than ever the Personal Computer can be a productive tool, an efficient tool that works like a whiz, making you a whiz, too.

So if there is anything final to say in this Guide, it would have to be this: Relax and enjoy the Quadlink. It was designed to work so that you never really know it's there tucked away inside the PC. To you, it should just be a matter of a few simple keystrokes before you're off and running: having fun with new video games, teaching yourself French, or developing a sales strategy for the office.

But practice a bit with Quadlink at first. And expect to make a few mistakes in the beginning. These mistakes, you'll find, will help you master the operation of the Quadlink in no time. With this mastery, you'll be able to do more with your IBM PC than ever before. And you'll do it in such a simple way that it may truly amaze you.

Good luck. Have fun. And enjoy.

## SPECS

### Soft Screen Switches

Screen	Switches		
	Hex Address	Hex	Decimal
Hi-Res Screen	\$C057	49239	-16297
Low-Res Screen	\$C056	49238	-16298
Secondary Screen (Page 2)	\$C055	49237	-16299
Primary Screen (Page 1)	\$C054	49236	-16300
Graphics with Text Screen	\$C053	49235	-16301
Text or Graphics Screen	\$C052	49234	-16302
Standard Text Screen	\$C051	49233	-16303
Graphics Screen	\$C050	49232	-16304

### The Quadlink Display

<b>Display type:</b>	Memory mapped into system RAM
<b>Display modes:</b>	Text, Low-Resolution Graphics, High-Resolution Graphics
<b>Text capacity:</b>	960 characters (24 lines, 40 columns)
<b>Character type:</b>	5 × 7 dot matrix
<b>Character set:</b>	Upper case ASCII characters
<b>Character modes:</b>	Normal, Inverse
<b>Graphics capacity:</b>	1,920 blocks (Low-Resolution) in a 40 by 48 array 53,760 dots (High-Resolution) in a 280 by 192 array
<b>Number of colors:</b>	16 (Low-Resolution Graphics) 6 (High-Resolution Graphics)

## Quadlink System Memory Map

### Hex Address

48K RAM - \$00,\$01,\$02,...\$BE,\$BF

48K I/O RAM - \$C0,\$C1,...\$C6,\$C7,\$C8,\$C9,...\$CE,\$CF

12K Monitor Ram - \$D0,\$D1,...\$FE,\$FF

### Decimal

48K RAM - 0,1,2...190,191

48K I/O RAM - 192,193...198,199,200,201...206,207

12K Monitor RAM - 208,209...254,255

## Memory Ranges for the Screen Display

Screen	Page	Hex	Decimal
		Addresses	Addresses
		Start/End	Start/End
Standard Text	Primary	\$400/\$7FF	1024/2047
	Secondary	\$800/\$BFF	2048/3071
Low-Resolution Graphics:	Primary	\$400/\$7FF	1024/2047
	Secondary	\$800/\$BFF	2048/3071
Hi-Resolution Graphics:	Primary	\$2000/\$3FFF	8192/16383
	Secondary	\$4000/\$5FFF	16384/24575

## I/O Locations

	Hex Address	Decimal Address
Flag Input (Read)	\$C061/\$C062/ \$C063	49249/49250/49251 -16287/-16286/-16285
Analog Input	\$C064/\$C065/ \$C066/\$C067	49252/49253/49254/49255 -16284 thru -16281
Analog Clear	\$C070	49264 -16272
Annunciators	\$C058/\$C05F	49240/49247 -16296 thru -16289
Speaker	\$C030	49200 -16336
Utility Strobe	\$C040	49216 -16320

## Text Window Special Location Valve Ranges

	Hex Valve min/norm/max	Decimal Valve min/norm/max	Hex Address	Decimal Address
Top	\$0/\$0/\$18	0/0/24	\$22	34
Bottom	\$0/\$0/\$18	0/24/24	\$23	35
Left	\$0/\$0/\$17	0/0/39	\$20	32
Width	\$0/\$28/\$28	0/40/40	\$21	33

### Annunciator Locations

#	Hex Address	Decimal Address
3/on	\$C05F	49247 -16289
3/off	\$C05E	49246 -16290
2/on	\$C050	49245 -16291
2/off	\$C05C	49244 -16292
1/on	\$C05B	49243 -16293
1/off	\$C05A	49242 -16294
0/on	\$C059	49241 -16295
0/off	\$C058	49240 -16296

### KEYBOARD LOCATIONS

	Hex Address	Decimal Address
Key Input	\$C000	49152 -16384
Strobe Clear	\$C010	49152 -16368



### Secondary Screen Mode Combinations

Screen	Switches	(Hex)
Hi-Res with text	\$C053	\$C050
	\$C055	\$C057
Low-Res with text	\$C053	\$C050
	\$C055	\$C056
Hi-Res only	\$C052	\$C050
	\$C055	\$C057
Low-Res only	\$C052	\$C050
	\$C055	\$C056
Standard text	\$C055	\$C051

### Primary Screen Mode Combinations

Screen	Switches	(Hex)
Hi-Res with text	\$C053	\$C050
	\$C054	\$C057
Low-Res with text	\$C053	\$C050
	\$C054	\$C056
Hi-Res only	\$C052	\$C050
	\$C054	\$C057
Low-Res only	\$C052	\$C050
	\$C054	\$C056
Standard text	\$C054	\$C051





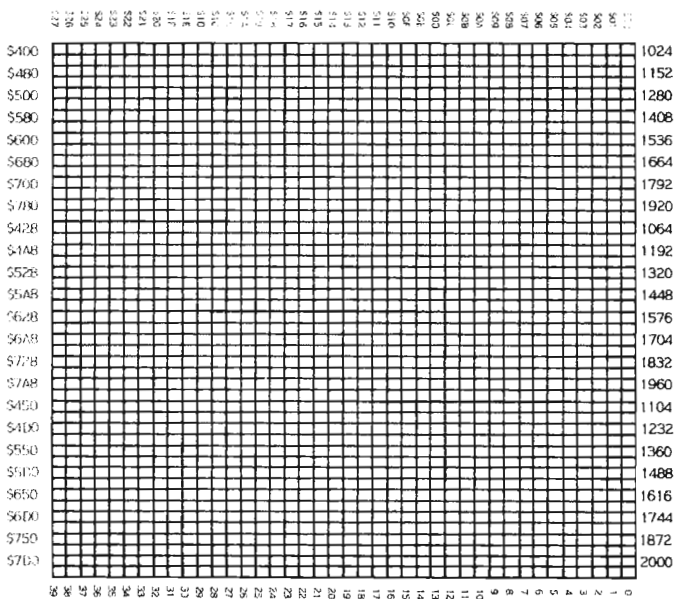

Map of the Low-Resolution Screen

## SOFTWARE

This preliminary list of available Quadlink software is best used as an indicator to the kinds of software compatible with the Quadlink. In laboratory tests, each of the listed programs successfully booted and ran. However, Quadram cannot guarantee that all listed software will run in every system configuration.

<b>Publisher</b>	<b>Software</b>
<b>ARTSCI-</b>	Magic Speller Magic Window Magic Window II
<b>Apple Computer-</b>	Apple Adventure Apple II Business Graphics Apple Logo Apple Pascal 1.1 Apple Pilot Apple Project Manager Apple Stellar Invaders Applewriter Applewriter II Plan 80 Visicalc Real Estate Templates
<b>Applied Software Technology-</b>	Versaform Tutorial Disk
<b>Avante Garde-</b>	Jump Jet Hi-res Computer Golf
<b>Beagle Brothers-</b>	Apple Mechanic DOS Boss Double Take Pronto-DOS Utility City
<b>Broderbund-</b>	Bank Street Writer Galactic Revolution Galactic Trader
<b>BudgeCo-</b>	Pinball Construction Set

<b>CALL A. P. P. L. E.-</b>	Applesoft Carpenter
<b>California Computers-</b>	Ultima
<b>California Pacific Computers-</b>	Bill Budge's Space Album Bill Budge's Trillogy of Games
<b>Cavalier Computer-</b>	Bug Attack Microwave
<b>Central Point Software-</b>	The Filer Copy II Plus
<b>DSR Inc.-</b>	Diversi-DOS
<b>Datamost-</b>	Aztec Adventure Casino Crazy Mazey Cribbage/Solitaire Market Magic Money Munchers Pandora's Box Pig Pen Real Estate Investment Program Snack Attack Spectre Swashbuckler Tharolian Tunnels The Property Manager Thief Tubeway
<b>ELCO Systems-</b>	Professional Job Accounting (PJACS)
<b>Edu-Ware-</b>	Algebra Series Compu-Math: Arithmetic Skills Compu-Read 3.0 Compu-Spell Compu-Spell (Adult/Secretarial level 99) Compu-Spell Data diskette: Levels 4, 5, 6, 7, 8 Counting Bee Edu-Ware Decimals Edu-Ware Fractions Metri-vert PSAT Word Attack Skills Perception 3.0 Rendezvous SAT Word Attack Skills

	Spelling Bee Games Spelling Bee With Reading Primer Statistics 3.0 Uni-solve Windfall
<b>Edu-Ware/Interactive Fantasies-</b>	Empire I: World Builders Empire II: Interstellar Sharks Network Prisoner II Terrorist
<b>Hayden Software-</b>	Hist-Graph Reversal Sargon II
<b>InSoft-</b>	Electric Duet GraForth
<b>Infocom-</b>	Zork Zork II
<b>Lightning Software-</b>	Master Type
<b>Med Data-</b>	Medpac Release 6.2
<b>Micro Corp.-</b>	Intelliterm PC V1.04
<b>Mircolab-</b>	Miner 2049'er
<b>Mircosoft-</b>	Microsoft Decathlon
<b>Mind Games-</b>	The Desecration
<b>Muse Software-</b>	ABM Castle Wolfenstein Robotwar
<b>On-Line Systems-</b>	Crossfire Screenwriter II Ultima II Pegasus II Threshold Hires Football
<b>Penguin Software-</b>	Crime Wave Pie Man Special Effects Spy's Demise The Complete Graphics System II The Graphics Magician Thunderbombs Transylvania

<b>Piccadilly Software-</b>	Star Blaster Succession Suicide Warp Destroyer
<b>Program Design, Inc.-</b>	The Time Bomb Analogies/32K Astro Quotes/32K Code Breaker Minicrossword/32K Number Series/32K Preschool IQ: Builder 2 Quantitative Reading Comprehension: What's Different Spelling Builder/32K Step By Step Two The New Step By Step Vocabulary Builder: 1/32K, 2/32K
<b>S &amp; H Software-</b>	Universal Boot Utility
<b>SSI-</b>	Bomb Alley Broadsides Computer Baseball Cosmic Balance Cytron Masters Fighter Command Napoleon's Campaign: 1813 & 1815 Ringside Seat S.E.U.I.S. The Warp Factor
<b>Sensible Software-</b>	Sensible Speller
<b>Silicon Valley Systems-</b>	Demo Word Handler E-Z Learner Rapid Reader The Demo Word Handler Turbo Charger
<b>Sir Tech Software-</b>	Knight of Diamonds Wizardry
<b>Sirius Software-</b>	Dark Forest Freefall Phantom 5 Pulsar II Audex



**Skillcorp Software Inc.-** Computerized Management System

**Software Farm-** Monster Mash

**Special Delivery Software-** Apple Designer  
Galactic Wars

**Stoneware-** Aristotle's Apple

**SubLOGIC-** A2-3D1 (3-D Graphics Package)  
Music Maker  
Roadblock  
Saturn Navigator  
Space Vikings  
Wholebrain Spelling

**Synergistic Software-** Adventure to Atlantis  
Odyssey, The Complete Adventure  
U-Boat command

**Terrapin, Inc.-** The Terrapin

**The Boston Company** Micro PMS

**Publisher** **Software**

**United Software of America-** Space Raiders  
Super Graphics

**Up-date-** Computer Quarterback

**Versa Computing-** Battlesight

**Virtual Combinations-** Micro Cookbook

**Visicorp-** Visicalc  
Visifile

**Xerox Education Publications-** The Stickybear ABC

**Zweig Associates-** Zweig Computerized  
Management System

**\*The following software did not work in preliminary tests due to the protection schemes involved:**

**Broderbund-** Choplifter  
David's Midnight Magic  
Seafox  
Serpentine  
Genetic Drift  
Red Alert  
Starblazer  
The Arcade Machine

<b>BudgeCo-</b>	Raster Blaster
<b>Dakin5-</b>	Rings of Saturn
<b>Datamost-</b>	County Fair Gin Rummy Mars Cars
<b>Hayden Software-</b>	Go Wargle
<b>InSoft-</b>	Spider Raid Zargs
<b>Piccadilly Software-</b>	Falcons
<b>Prairie Software Systems-</b>	Starter Charter Technical Charter
<b>SDC-</b>	NORAD
<b>SSI-</b>	Cartels & Cutthroats Geopolitique
<b>Sensible Software-</b>	Back-it-Up II
<b>Silicon Valley Systems-</b>	List Handler & Utility Disk The Snapper The Word Handler II Toddler's Tutor
<b>Sirius Software-</b>	Autobahn Bandits Beer Run Borg Cops and Robbers Epoch Gorgon Orbitron Sneakers
<b>Skillcorp Software Inc.-</b>	Assisted Instructional Development System
<b>Stoneware-</b>	DB Master
<b>SubLOGIC-</b>	FS-1 (Flight Simulator)

\* Most half track protection schemes will not work on standard IBM PC's. Consult your dealer.

## LITERATURE

The following list of available literature is intended to present you with a source for information which you can pursue if you wish to gain a better understanding of computers in general and the Quadlink specifically. But Quadram does not endorse or support the specific information found in this literature.

Advanced Applesoft Basic  
M.E.C.C.  
2520 Broadway Dr  
St. Paul MN 55113  
1982

Apple Backpack  
Kamins & Waite  
BYTE Books  
70 Main St.  
Peterborough, NH 03458  
1982

The Apple Personal Computer for Beginners  
Dunn & Morgan  
Prentice-Hall  
320 Hudson Terrace  
Englewood Cliffs, NJ 07632  
1982

Applesoft Special Features  
M.E.C.C.  
2520 Broadway Dr.  
St. Paul, MN 55113  
1982

Applesoft Basic Workbook  
Mears  
Addison-Wesley  
Reading, MA 01867  
1983

Applesoft Basic Reference Guide  
Wintermeyer  
Addison-Wesley  
Reading, MA 01867  
1983

Apple II Programmer's Handbook  
Vile  
Prentice-Hall  
320 Hudson Terrace  
Englewood Cliffs, NJ 07632  
1982

Apple II Word Processing  
Poling  
Que Corp.  
6515 E. 82nd St. Suite 110  
Indianapolis, IN 46250  
1981

Automated Accounting for the Microcomputer  
Allen & Klooster  
Southwestern Publishing  
5101 Madison Rd.  
Cincinnati, OH 45227  
1982

Bag of Tricks  
Worth & Lechner  
Quality Software  
6660 Reseda Blvd., Suite 105  
Reseda, CA 91335  
1982

Basic and Graphics  
Barclay & Tinker  
T.E.R.C.  
8 Eliot St.  
Cambridge, MA 02138  
1982

Basic Apple Basic  
Coan  
Hayden Book Co.  
50 Essex St.  
Rochelle, NJ 07662  
1982

Basic Exercises for the Apple  
Lamoitier  
Sybex  
2344 6th St.  
Berkeley, CA 94710  
1982

Basic for the Apple II  
Programming and Applications  
Goldstein  
Brady/Prentice-Hall  
Bowie, MD 20715  
1982

Basic for Business  
Hergert  
Sybex  
2344 Sixth St.  
Berkeley, CA 94710  
1982

Basic for the Apple II  
Brown/Finkel/Albrecht  
John Wiley & Sons  
605 3rd Ave.  
New York, NY 10158  
1982

A Basic Programmers Guide to Pascal  
Borgerson  
John Wiley & Sons  
605 3rd Ave.  
New York, NY 10158  
1982

Beginning Applesoft Basic  
M.E.C.C.  
2520 Broadway Dr.  
St. Paul, MN 55113  
1982

Computer Programming for Kids  
and Other Beginners(Apple)  
Van Horn  
Sterling Swift  
1600 Fortview Road  
Austin, TX 78704  
1982

Computer Graphics  
Myers  
Addison-Wesley  
Reading, MA 01867  
1982

The Creative Apple  
Creative Computing  
39 E Hanover Ave.  
Morris Plains, NJ 07950  
1982

Data Plotting on Micros  
Korites  
Kern Publishing  
P.O. Box 1029  
Duxbury, MA 02332  
1982

Discovering Computers  
Gledhill  
Science Research Assoc.  
155 N. Wacker Dr.  
Chicago, IL 60606  
1982

Executive Planning with Basic  
Biu  
Sibex  
2344 6th St.  
Berkeley, CA 94710  
198?

Guide to Programming in Applesoft  
Presley  
Van Nostrand Reinhold  
7625 Empire Drive  
Florence, KY 41042  
1982

Hands-On Basic for the Apple II  
Peckham  
McGraw-Hill/College  
1221 Ave. of the Americas  
New York, NY 10020  
1982

Intermediate Applesoft Basic  
M.E.C.C. 2520 Broadway Dr.  
St. Paul, MN 55113  
1982

Kids and the Apple  
Carlson  
Datamost  
9748 Cozycroft Ave.  
Chatsworth, CA 91311  
1982



101 Apple Computer Programming  
Tips and Tricks  
ARcsoft  
P.O. Box 132  
Woodsboro, MD 21798  
1982

Picture This Too!  
Intro to Computer Graphics for Kids of all Ages  
Thornburg  
Addison-Wesley  
Reading, MA 01867  
1982

Survival Kit for Apple Computer  
Spangenburg & Moser  
Wadsworth Electronic Pub. Co.  
10 Davis Drive  
Belmont, CA 94002  
1982

Addison-Wesley Book of Apple Software 1983  
Stanton & Dickey  
Addison-Wesley  
Reading, MA 01867  
1983

Apple Freeloader  
American Software  
P.O. Box 57221  
Washington, DC 20037

## MAGAZINES

Call - A.P.P.L.E.

Apple Puget Sound Program Library Exchange  
21246 68th Avenue South  
Kent, Washington 98032  
\$20/year plus \$25 one time membership fee

Softalk - Apple Version

Softalk Circulation  
Box 60  
North Hollywood, Ca. 91603

Micro

Micro Ink.  
34 Chelmsford Street  
P.O. Box 6502  
Chelmsford, Mass. 01824  
\$24/year

## GLOSSARY

### A

**Acoustic coupler:** A device that allows a telephone handset to be connected to a modem.

**Address:** The specific location or destination of a certain piece of data or information, usually associated with a particular number.

**Algorithm:** A well-defined set of ordered and logical steps to the solution of a particular problem. The structure of a BASIC program is an example of an algorithmic form.

**Allocate:** To set aside for use in a specific operation or task.

**Alphabetic character:** Any of the letters of the alphabet.

**Amps; Amperes:** A measurement of electrical current or power.

**Append:** The capability of a computer to concatenate various data files, so as to allow a data manipulation program to correlate the data.

**Apple DOS 3.3:** The latest version of the software needed to run the Apple personal computers.

**Applesoft:** A form of BASIC written especially for use on the Apple computer. The Quadlink is also capable of running this form of BASIC which the Quadlink calls Floating Point BASIC.

**Application Program:** A software program written to be applied to one certain discipline, such as accounting, business graphics, word processing.

**ASCII:** The common name for the American Standard Code for Information Interchange, which gives the characters available on a keyboard an assigned value from 0 to 127.

**Assembler:** A low-level language, one step up from machine language, which uses mnemonics and symbols to address the machine language of the computer.

**Assembly language:** See Assembler above.

**Async Adapter:** A plug-in card which allows the computer to transmit data asynchronously.

**Asynchronous transmission:** Transmission in which the time intervals between transmitted characters may be of unequal length. Transmission is controlled by start and stop bits at the beginning and end of each character.

**Attribute:** A characteristic either assigned or integral to a particular unit, device, or value.

## **B**

**Backup:** A spare or copy of the original. When working with system software provided on disks, the back-up is made to use with the system and the original, or master, is stored away for protection.

**BASIC:** Beginners All-purpose Symbolic Instruction Code is a high-level computer language.

**BASICA:** An advanced form of BASIC. The "A" means advanced.

**Batch Processing:** A system by which a computer performs one job at a time, with no chance for human interaction during the job.

**Baud:** A unit of signalling speed usually measured in bits-per-second. The baud rate is roughly equal to the number of bits the computer can pass every second.

**Binary:** Pertaining to the numbering system with only two variables: 0 and 1. Personal computers use this system to transmit and store information. This is done through electrical circuits which are active when they contain a value of one, and inactive when they contain a value of zero.

**Bit:** A binary digit, and the smallest value a computer can process. It is one "on/off" code, the generation of one open or closed circuit.

**Black and White Toggle:** A toggle switch to enable or disable the color circuitry of the Quadlink.

**Blank:** Empty. When referring to a floppy disk, a blank disk is one which is brand new, a disk as of yet uninitialized. Blank disks cannot be operated in a disk operating system.

**BLOAD:** An Apple DOS command used to load a binary file into system memory.

**Board:** Usually a fiberglass card onto which circuit paths are etched and circuit chips are installed. Also referred to as a printed circuit board.

**Boot:** To start-up, to turn on. Booting the system brings the system up from a cold start.

**Bps:** A unit of signalling speed which stands for Bits Per Second. It is what determines the baud rate.

**BSAVE:** An Apple DOS command used to save a binary file from system memory onto a disk.

**Bubble memory:** Permanent, nonvolatile magnetic memory which does not lose its data when power is turned off. The data is stored in magnetic bubbles as opposed to silicon chips.

**Buffer:** A device or area of RAM used to store information temporarily, usually to compensate for a difference in the rate of flow of data.

**Byte:** A unit of eight bits and the basic unit of measure in a computer.

## C

**Catalog:** In the Quadlink mode, this is a command to show a directory of all the files contained on a disk. The catalog can be called up on the display screen to tell a person what files are on the disk.

**Centronics:** A recognized standard for parallel interfaces, interfaces which transmit data in parallel, one byte at a time.

**Character:** A letter, digit, or symbol that is used as part of the organizational control or representation of data.

**Chip:** Short for integrated circuit chip, a silicon-based device that is designed to store or process electrical information.

**Chronograph:** A fancy name for a clock/calendar, a device used in the computer to generate accurate time and date information.

**Circuit:** A path specially designed to transfer electrical impulses from one area to another.

**Clock/calendar:** A not-so-fancy name for chronograph. See chronograph.

**Cluster:** A term used to describe a terminal configuration in which two or more terminals are connected to a single line or modem.

**Cold Start:** To work on the computer just after it has initially been turned on.

**Command:** A language code entered by the user which instructs the computer to process information in a certain way.

**Compatible:** Able to work with; When two devices are able to work together they are considered compatible.

**Computer:** Any electronic instrument which can store a specific set of instructions, process incoming data based on this set of instructions, and send this data out in some way to an external peripheral.

**Constant:** An item of fixed value or worth, unchangeable.

**CRT:** A Cathode Ray Tube. The ions which produce the image on a TV screen are generated by a cathode ray tube.

**Cursor:** A marker which moves in relation to where a person is seeking or displaying data.

## D

**Data:** Information in any form.

**Data Set:** A term used by the Bell Telephone System for their modulators-demodulators. The term is synonymous with modem.

**Default:** A variable preset to a specific value; in relation to the Quadlink, default is used to indicate the drive the Quadlink's microprocessor automatically activates whenever it is told to read from or write to a floppy disk.

**Directory:** A list of identifiers or references to corresponding items of data. Usually a listing of files contained on a disk.

**Disable:** To turn off, or prevent from operating.

**Disk:** A magnetically-coated circular device to which data can be electronically stored and retrieved.

**Disk Drive:** An electro-mechanical device which is designed to read and write data to a disk.

**Disk emulator:** Nonpermanent random access memory which, when combined with the appropriate software, can read or write data for future use.

**Display:** An output device which usually places data on a video screen for reference by a user.

**DOS:** Stands for Disk Operating System. Though most people refer to DOS as the software that runs the system. A disk operating system is any computer system that uses disks in its information processing operations.

**Dumb Terminal:** A terminal usually consisting of such input/output devices as a keyboard and a monitor, but incapable of any independent data processing.

**Dynamic RAM:** System RAM which periodically must be refreshed in order to keep its data intact. This refreshing is done automatically by the PC.



## E

**Edit:** To enter, modify, or delete data

**Editor:** Either the program which interprets commands to enter, modify, or delete data, or the actual person who enters the commands from the keyboard.

**Enabled:** To turn on, to make ready for work

**Execute:** To carry out an instruction or a command in a computer program

**Execution environment:** The manner in which commands or instructions are carried out in the processing of data in a computer program.

## F

**F Key:** A function key on the keyboard; capable of being user-programmed to perform a specific operation during the processing of program data.

**File:** A unique set of information treated as a unit.

**Floating Point BASIC:** A form of BASIC that can process fractional numbers.

**Floppy disk:** A small magnetic medium made of a flexible material and capable of storing data for use in a computer.

**Font:** A family of characters sharing the same style of appearance or size.

**Format:** The form of something.

**Form feed:** Specially sprocketed paper that can be sent continuously through a printer during a print operation. The sprockets allow for a steady and even feed of the paper.

**Freeze:** To hold unaltered in its present state

**Function:** A defined operation

## G

**Gigabyte:** One billion bytes

**Graphics:** The interpretation of data into patterns of recognizable colors and shapes.

## H

**Handshaking:** A means of communication between two devices by which that status of each can be interpreted by the other.

**Hard copy:** A printed copy of computer output in a readable form

**Hardware:** Parts of a computing system that can be touched, such as the main logic board, any I/O cards, etc.

**Head:** The moving section of a disk drive that drops down onto a floppy disk and can read information from or write information to the disk.

**Hertz (Hz):** Cycles per second, a unit of frequency

**Hexadecimal:** A number system which uses the digits 0 through 9 and the letters A through F to represent the values in base 16.

**HIRES:** High resolution

**Host computer:** The main computer in a system which directs or controls all the others.

## I

**IC:** Integrated circuit chip; a small plate of silicon into which electronic circuitry has been etched.

**Initialize:** In the Quadlink mode, this means to prepare a disk for use with DOS.

**Integer:** Any of the whole numbers, such as 1, 675, 12,897,000.

**Integer BASIC:** A form of BASIC which only processes integers in whole numbers.

**Interface:** A shared boundary between two devices

**I/O:** Input/Output; usually refers to any device which can receive information from or send information into a computer.

## J

**Joystick:** A lever which can move in all directions to position a locator on the display screen.

**Jumper:** A piece of bus wire permanently installed between two feedthroughs on a printed circuit board. The jumper enables the circuits on the board to perform in a manner different from what was originally planned.

## K

**K:** An abbreviation for 1,024 bytes.

**Keyboard:** An input device designed with a coded set of keys to program information into the computer.

**Kilobyte:** 1,024 bytes

**L**

**Language:** An understandable and logical code which a programmer can use to process, store, and retrieve information in the computer.

**Line:** A string of alphanumeric characters and symbols extending from one edge of the video display screen to the other.

**Location:** Also called address, a location is any place in memory where data can be stored.

**Loop:** A set of instructions which may be continuously repeated while a given condition exists.

**Low-Res:** Low resolution

**LSI:** Large Scale Integrated Circuit

## M

**MB:** Megabyte or 1,024 K bytes

**Main frame:** A large computer

**Memory:** The area in a computer in which information can be stored.

**Menu:** A list of available options or selections which a person can choose from in performing operations on a program.

**Microcomputer:** A computer which processes data through a microprocessor.

**Minicomputer:** Basically, a minicomputer is no different from a main frame. If anything, minis may be a little smaller. But actually a minicomputer is a minicomputer because the manufacturer calls it a minicomputer.

**Mini Floppy:** A floppy disk measuring 5¼ inches in diameter.

**Modem:** A term which stands for Modulator-demodulator. A modem is capable of sending data over telephone lines.

**Monitor:** A video screen capable of receiving output from the computer and generating this output into a readable display for the end-user.

**Multifunction board:** A circuit card designed to be plugged inside a personal computer to enable the computer perform several additional functions.

**Multiplexing:** The means of connecting many input devices to be channeled through one output device.

## N

**Network:** An interconnection of computer system, terminals, and communication facilities.

**Noise:** Any type of electrical interference which may affect the operations of a computer or computing device.

**Nonvolatile memory:** Memory which retains the value of its information after power has been turned off.

**Nybble:** A common term for four bits, or half of a byte.

## O

**Operation:** A well-defined action which, when combined with a feasible combination of entities, produces a new entity.

**Operating System:** Commonly, the software which enables a particular computer to access disk storage devices.

**Output:** Any data sent out from the computer to a peripheral.

**Overwrite:** To erase by recording data over the space where other data resides.

**P**

**Page:** A screen of information as it appears on a monitor screen; or, a preset amount of data.

**Parallel Port:** An interface by which data can be transmitted from the computer in parallel.

**Parameter:** A name or value in a procedure that is used to refer to an argument passed to that procedure.

**Parity:** A means of testing the integrity of transmitted data. There are two types of parity -- even or odd.

**Peripheral:** A device which performs a function in the computer, but is not part of the computer itself. A printer is considered a peripheral device, as is a modem.

**Personal computer:** A typically small computing device which is self-contained, has memory, I/O and language capabilities, and is suited for the home or office environment.

**Port:** An access point for data entry or exit.

**Printed circuit board:** A thin sheet of fiberglass or some similar material, to which small metal traces have been etched. The board is designed to exchange information via the metal traces.

**Processor (or microprocessor):** An integrated circuit which lies at the heart of every personal computer. The microprocessor is specifically designed to understand and to execute machine language programs.

**Program:** An ordered sequence of coded commands and instructions which define a certain process.

**PROM:** Programmable Read-Only Memory; ROM which can be subjected to radiation, thus erased and re-programmed.

**Prompt:** An indicator from the computer for data input; most usually the prompt is displayed as some form of cursor on the video screen.

## Q

**Queue:** To call up; to make ready; to prepare for use

## R

**RAM:** Random Access Memory; RAM is the main computer memory. It is used to read information from and write information to the system. RAM is also volatile memory, in that it loses its data when power to the system is turned off.

**Remark:** A statement in the BASIC language that is not part of the actual program, but rather an explanatory note to the program. Remark statements are not executed with the rest of the program, but are listed with the other program lines.

**Resolution:** The measure of the sharpness of an image on the display screen, as determined by the number of dots per line and the number of lines per display area.

**ROM:** Read-Only Memory; Memory in the computer which can only be read for its program content, but this program content can never be changed or otherwise written to.

**RS-232C:** A recognized standard for the manner of information transfer in data communications. RS-232C is a serial standard.

**Run:** To execute a series of steps in a program and to bring these steps to their logical end.



## S

**Serial Port:** A serial port is a communications path into and out of a computer system over which data can be passed serially, or one bit at a time.

**Serial Transmission:** method of transmission in which each bit of information is sent sequentially on a single channel rather than simultaneously as in parallel transmission. Serial transmission is the normal means of transmission for data communications.

**Soft switch:** An on/off toggle switch that is turned on or off by the use of certain software commands instead of by using any type of physical switching device.

**Software:** Programs which control the way in which the hardware processes information.

**Statement:** A line in a BASIC program which specifies a meaningful operation or command.

**Syntax:** The rules and restrictions governing the structure of a computer language.

## T

**Terminal:** A device capable of receiving and transmitting information and usually contains a keyboard and a monitor.

**Text:** Written forms of human language rather than computer language. Text is made up of letters and other linguistic characters common to human data transfer.

**Timesharing:** A system that allows more than one user to have subjectively simultaneous access to a computer or peripheral.

**Toggle switch:** A switch with two stable states, on and off.

## V

**Video:** Data presented on the face of a monitor screen, or any screen, where the source is generated from a cathode ray tube.

**Volatile memory:** Memory which loses its information any time power is turned off to the computer. RAM is a good example of volatile memory.

## W

**Warm Start:** To begin working with the computer again after temporarily relinquishing control to another language or program.

**Window:** The space on the monitor screen that is capable of displaying any portion of a page of information.

**Write:** To record information; to store information electromagnetically and in code, for later use or reference.

# Get more out of your Personal Computer system with these other fine Quadram Products



## Quadboard

Quadram's Quadboard is a nine-function expansion board for the IBM Personal Computer. It is designed to greatly increase the PC's capabilities for minimum cost while using only one internal expansion slot. The functions provided on this one board include: Random Access Memory (RAM) expansion from 64K to 384 K bytes in 64K increments, an EIA RS-232C Serial Interface for asynchronous communications, a Centronics compatible parallel interface for printer driving, a game port, and a battery-powered Quartz clock/calendar to keep your PC's internal clock always on time.

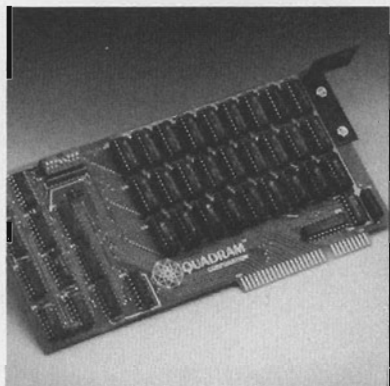

## Memory Expansion Board

Perfectly compatible with other peripheral cards, Quadram's Memory Expansion Board is designed to increase the random access memory capacity of the IBM Personal Computer in 64K byte increments up to 192K. The Memory Expansion board has been manufactured with performance and reliability in mind, and has been constructed of only high-quality material and components. Each board has been burned-in and thoroughly tested to insure many years of dependable service.

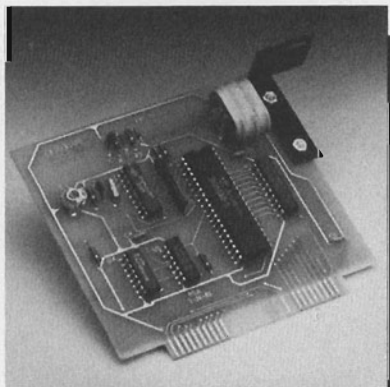

## Clock/Calendar

The Clock/Calendar Card from Quadram Corporation is a small plug-in unit designed for the IBM Personal Computer. It provides an accurate crystal-controlled date/time keeping function which automatically sets the IBM DOS internal clock/calendar whenever DOS is booted from a diskette. The card is powered by a self-contained battery automatically recharged by the computer, and provides continuous time keeping even when the computer is off for long periods of time.

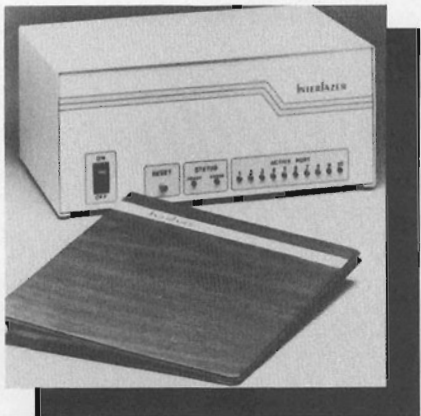

### **Interfazer**

The Interfazer from the Quadram Corporation is an intelligent peripheral controller/buffer designed to provide interfacing and priority control for up to eight input devices feeding and sharing one or two output devices. The inputs and outputs may be in any combination of serial or parallel. The Interfazer's state-of-the-art design allows it to function as a multi-user printer controller, an incompatible device interface, a computer I/O expander, a peripheral multiplexer, a data transfer rate converter, and an additional peripheral buffer.

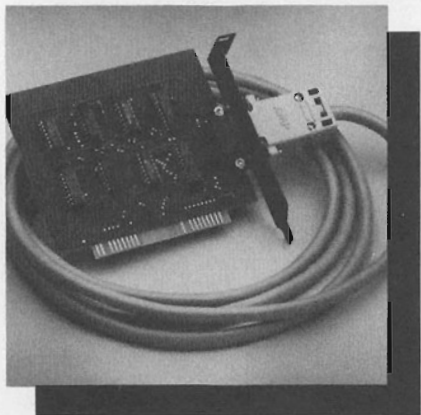

### **IPIC**

Quadram's IPIC (IBM Parallel Interface Card) is a general purpose Centronics parallel interface card complete with cable for the IBM Personal Computer. It is specifically designed to drive printers, but may be used as an I/O driver for any parallel device that matches its input/output capabilities. The IPIC works exactly like IBM's Parallel Printer Adapter and supports the graphics function on many common graphics printers including IBM, Epson, Centronics, and others.

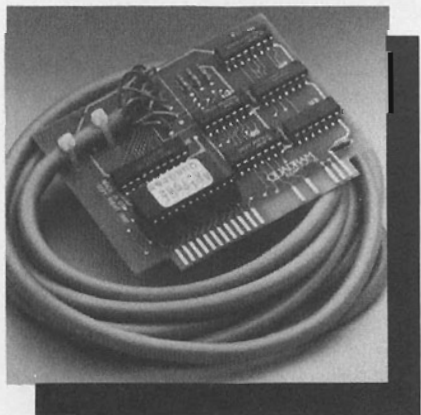

### **APIC Graphics**

The Apple Parallel Interface Card is manufactured by the Quadram Corporation as a Centronics compatible parallel interface for the Apple II and Apple II+ computers. The card contains a graphics option. Both Apple Graphics pages can be printed from the screen with several simple commands.

APIC-G has many text features, including adjustable margins, page length, line length, and others. APIC-G is available for several types of printers.

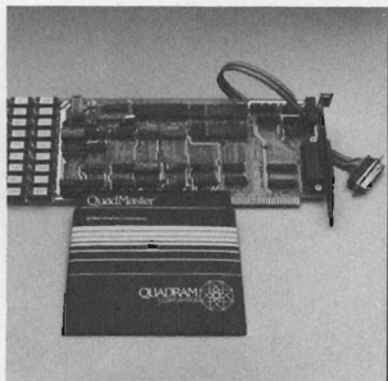

### Quadboard II

Quadram's Quadboard II is an all-on-one board which combines six IBM PC functions in one. This multifunction board combines two serial ports, chronograph, memory expansion, RAM disk and spooler — all compatible with IBM PC hardware. The two RC-232 async ports can be used for modems, printers, and other serial devices. Memory expansion is socketed and fully expandable in 64K increments up to 256K. Full parity generation and checking are standard.

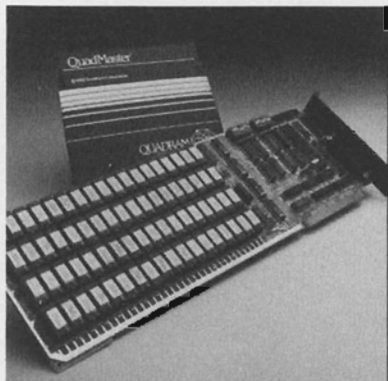

### Quad 512+

Now IBM PC owners can enjoy faster computing times and more capabilities with the Quad 512+. This new board from Quadram combines memory expansion of 512K RAM in increments of 64K, 256K, or 512K; a serial port; RAM disk; and spooler. The RS-232 async serial port uses the same chip as the IBM serial board and is used for connecting modems, printers, and other serial devices. QuadMaster software with QuadRAM Drive and spooler is included.

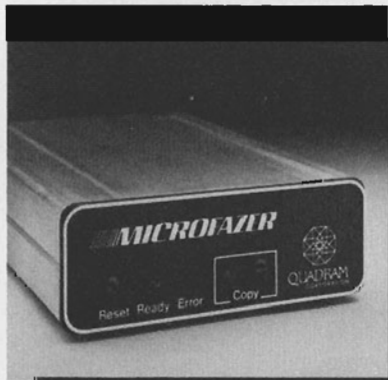

### Microfazer

The Quadram Microfazer is a universal print buffer with 8K to 512K RAM — the first with a half-megabyte! The Microfazer receives information in its memory, then sends it to the printer at an appropriate speed. The Microfazer comes with a copy feature allowing additional copies of the buffered information. The unit is sized to stack with popular modems and other peripherals; and some even plug directly into the printer!

### Quad I/O

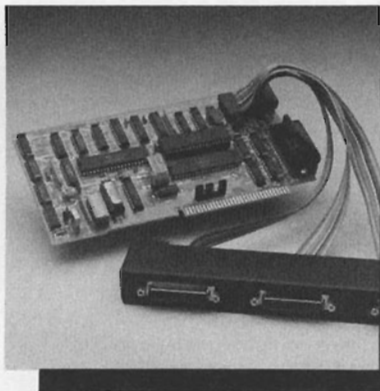

Quadram's Quad I/O combines up to five of the most-needed IBM PC input/output devices onto one card. This multifunction board contains a parallel port designed to operate most printers and other parallel devices; a battery-powered chronograph — an extremely accurate real-time clock/calendar; a game port for game paddles, fire buttons, or joysticks; a serial port for connecting modems, printers, and other serial devices; plus an optional second serial port which can be ordered with the board or added at a later date.

### Quadscreen



Quadscreen is a high-resolution (960 x 512), bit-mapped, "big-screen" monitor for the IBM Personal Computer. The large monochrome screen can display 10,240 characters — more than five times the screen capacity of IBM's PC monitor. Dot addressability, super spreadsheet, and split-screen functions are some of the distinctive elements of Quadscreen that maximize graphics capabilities and increase word processing efficiency. Quadscreen comes with monitor, connector cable, and a video card with 128K bytes of available RAM.

### Quadchrome



This is the perfect monitor for any data processing environment — Quadchrome by Quadram. Quadchrome is a high-resolution (690 x 240) RGB color monitor designed with an NEC .31 dot pitch cathode ray tube. The high resolution makes Quadchrome perfect for word processing, spreadsheet programs, and other common business applications. But Quadchrome also has amazing color capabilities. It's able to produce up to 16 different colors on the screen at once. This makes Quadchrome perfect for color graphics work, too.

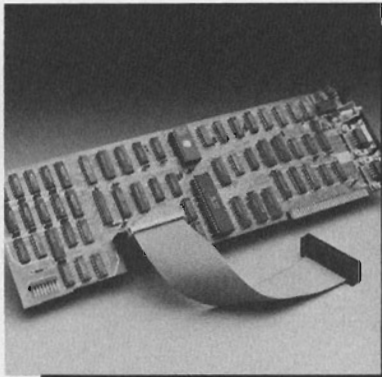

### **Quadlink**

Quadram introduces Quadlink, the revolutionary enhancement board that turns your IBM Personal Computer into an Apple-compatible system. Quadlink is an Apple-emulator that plugs into one of the PC's expansion slots. The board uses the same disk drives and I/O devices as the PC, working in complete harmony with the computer system. With Quadlink, no diskette reformatting is necessary. Just put the Apple diskette in the drive and watch it go.

Quadlink comes complete with printed circuit board and all the necessary cables for integrating the board into the system. Plus there's software for booting the Quadlink and running the Apple DOS 3.3 and thorough documentation explaining the installation and operation of the board.

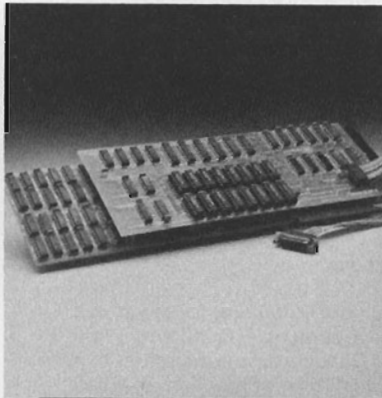

### **Quadcolor I and II**

Quadram presents Quadcolor, the most powerful color graphics adapter package available today. Quadcolor is perfectly compatible with the Personal Computer and XT and comes in two versions.

Quadcolor I has 32K of on-board RAM for up to 16 active video pages in text mode and two complete pages in graphics mode. Plus, you get a choice of two true colors in high-resolution mode with Quadcolor I.

Snap Quadcolor II onto Quadcolor I for 96K of RAM and choose from 136 different colors for ultra high-resolution bit-mapped graphics. Quadcolor II also comes with BASICQ, an enhanced graphics software package that's powerful and easy to use.

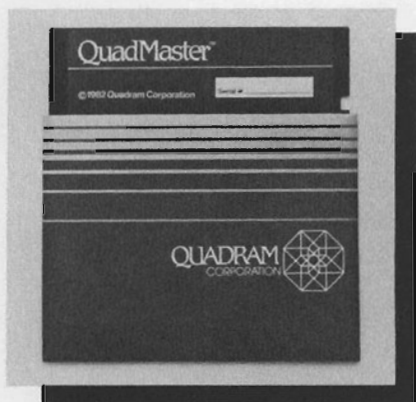

### **QuadMaster Software**

Quadram's QuadMaster software package provides you with software routines that enhance the operation of the IBM Personal Computer and XT. QuadMaster software contains the QuadRAM Drive program, a program designed to give you up to three RAM drives using part of system memory. The package also contains MasterSpool, a program that allows for part of system memory to be used as a software print buffer. Additionally, the program Qswap allows you to change LPT1 and LPT2 back and forth, electronically, as often as you wish.

**For more information on these  
and other fine Quadram Products  
write or call us at:**

**Quadram Corp.  
4355 International Blvd.  
Norcross, GA 30093  
(404) 923-6666**

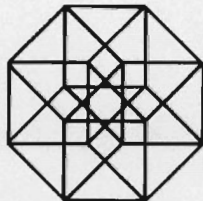



## **THE QUADRAM QLIQUE (pronounced clique) WANTS YOU!**

### **You're special to us . . .**

As a Quadram product owner, you're very special to us. You've become a preferred customer. And as a preferred customer we want to keep you updated on what's happening at Quadram. That's why we want you in the Qlique (pronounced clique). The Quadram Qlique is a special membership of all our preferred customers. As a member in the Qlique you'll receive information on new product releases, general information about Quadram's complete line of microcomputer enhancements, plus free periodic software updates and specials on such things as out-of-warranty service contracts. It's a great way to "stay tuned" to what's happening at Quadram!

### **Joining the Qlique is easy . . .**

It's free! All you have to do is complete the attached card and mail it back to us. We'll put you on our membership list and make sure you stay up-to-date on the exciting things going on at Quadram.

C'mon. Get in tune. Join the Qlique by sending in the card today.