

Cover design by Andrea

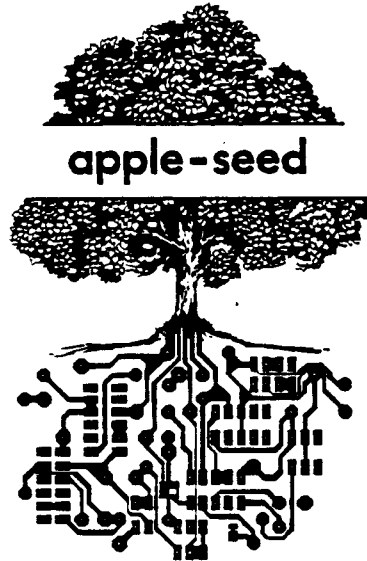

COMPUTER ASSEMBLY MANUALS
by
RAYMOND KOSMIC

SURF BOARD: Assembly Guide for the 6502-based SURF BOARD
Motherboard
APPLE-SEED I: Motherboard Assembly Manual
APPLE-SEED II: Assembly Guides for Apple-compatible Motherboards
and Peripheral Circuit Cards
APPLE-SEED II UP DATE: Latest Thirty Guides from APPLE-SEED II
BIG BLUE SEED: Assembly Guides for IBM-compatible Motherboards
and Peripheral Circuit Cards
BIG BLUE SEED UP DATE: Latest Twenty-five Guides from the BIG
BLUE SEED

Published by NuScope Associates

Printed in Canada

Copyright © 1984

NuScope Associates

P.O. BOX 742, STN. B. WILLOWDALE, ONTARIO M2K 2R1 •

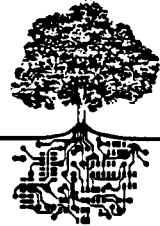

IMPORTANT NOTICE

All rights are reserved. No part of this manual may be reprinted, or reproduced, or transmitted in any form, including photocopy, without the prior consent of the publisher.

The information presented in this manual has been carefully reviewed and is believed to be entirely correct and reliable. However, the author and publisher assume no responsibility for errors and/or omissions, or for the success or failure of the different applications to which the information presented in this manual may be applied. Neither is any liability assumed for any infringement of patents or other rights of third parties that would result.

Apple is the registered trademark of Apple Computer Inc.
IBM is the registered trademark of International Business Machines.
NuScope Associates is a Division of Kosmic MicroTech Inc.

To Juliet

PREFACE

This reference manual was prepared as an aid to those who wish to assemble Appletm-compatible peripheral circuit cards for their personal use. The sixty assembly guides presented here were originally prepared for Computer Parts Galore Inc., and Active Surplus Annex, and are distributed along with each card or kit as a parts list with condensed assembly instructions. The suppliers have kindly allowed us to compile these guides together into one reference manual.

Each one of the guides is complete in itself and is independent from the other guides. All have been checked for accuracy by the suppliers and our technical advisors, and are thought to be correct. However, with over four thousand components to be identified and correctly positioned on eighty-five cards, errors and/or omissions may occur. In no event will the suppliers or NuScope Associates be liable for damage resulting from the use of the information presented in this manual.

If you lack experience in electronics, you may wish to refer to the "apple-seed: Motherboard Assembly Manual". This self-directing guide was designed and written with the first-time hobbyist in mind, as an educational reference for the construction and assembly of electronic devices that use printed circuit boards, integrated circuits, and electronic devices.

It is planned to update this reference manual as other peripheral cards come to our attention. Any suggestions for improvement would be greatly appreciated.

ACKNOWLEDGEMENTS

I wish to express my appreciation to Tom Bell, Bramalea, John Kuzmich, Don Mills, and Andy Szego, Willowdale. Their valuable assistance and expert technical advice were instrumental in the completion of this manuscript.

ACKNOWLEDGEMENTS (Continued)

I also wish to thank the following suppliers for their encouragement and support, and for checking the accuracy of the peripheral circuit card guides as follows:

Rob Stewart and Bill Jackson of Computer Parts Galore Inc.,
316 College St W, Toronto, Ont, M5T 1S3:

Disk Controller (Two Drives); Disk Controller (Four Drives);
16 K RAM; 16 K RAM; Language; 128 K RAMCARD; ROM Integer;
80-Column; Z-80; Printer Buffer; Parallel Printer Interface;
Epson/Centronics Interface; Communications Interface; Serial;
Modemcard; Voice Machine; Copycard; EPROM Programmer; Time;
Input/Output; Multifunction; 80-Column/Soft Switch; Asynch-
ronous Interface; Music Machine; Three Voice Synthesizer;
AP-64 EPROM Writer, IEEE; A/D-D/A; Prototyping II.

Pete Brown and Fred Kohn of Active Surplus Annex, 345 Queen St
W, Toronto, Ont, M5V 2A4:

80-Column VK; Sprite Graphics; EK Z80; K-Modem300; Music
Card 1 and 2; Instrument Synthesizer MK1 and MK2 and Computer
Interface Cards; ROM Blaster; RGB; K-Clock; Prototyping I.

Bill Wood of 4863 South Livonia Road, Livonia, NY, 14487:

8" Floppy Disk Drive Controller

TABLE OF CONTENTS

PART I	GUIDELINES TO SUCCESS	1
	Safety	1
	Using This Guide	1
	Guide to Components	4
	Card Installation and Removal	10
	Card and Connector Pinout	12
	Appendix - Abbreviations	13
PART II	PERIPHERAL CARD ASSEMBLY GUIDES	16

SECTION	GUIDE	CARD
Motherboards	SB-1	6502 Motherboard I
	SB-2	6502 Motherboard II
	SBe-1	Beltron 6502B/65C02 Motherboard
	SBe-2	JK 6502B/65C02 Motherboard
	SB-3	Surf Board Motherboard
1 Disk Controller	1-1	Dual Disk Drive
	1-2	APL-Disk
	1-3	Quad Disk Drive
	1-4	Shugart Disk Drive Interface
	1-5	Disk-Writer Interface
	1-6	8" Floppy Disk Drive Controller
	1-7	Ace Dual Drive
2 Memory	2-1	16 K RAM
	2-2	16 K RAM
	2-3	Language
	2-4	128 K RAMCARD
	2-5	ROM Integer
	2-6	16 K RAM
	2-7	128 K RAM-Expander
	2-8	Z-80/64K 128 K RAM Expander
	2-9	Prelude 128 Extender
	2-10	Zip Loader
	2-11	Fast Disk
	2-12	Mega Works I (IIe)
3 Screen Display	3-1	80-Column
	3-2	80-Column (VK)
	3-3	Sprite Graphics
	3-4	80-Col/Soft Switch
	3-5	80 Column (IIe)
	3-6	80 Column/64 K Expander (IIe)
	3-7	College 80 Column/64 K (IIe)
	3-8	JK 80 Column/64K (IIe)

4 Co-Processor	4-1	Z-80	
	4-2	8088	
	4-3	EK Z-80	
	4-4	Z-80/64K	
	4-5	Z-80+	
	4-6	Prelude Speedy	
	4-7	Ace Z-80	
	4-8	Excel Z80 Card	
5 Parallel Interface .	5-1	Parallel Printer	
	5-2	Buffer Board	
	5-3	Parallel Printer	
	5-4	Epson/Centronics	
	5-5	Print-All	
	5-6	Micro-2-Buffer	
	5-7	Prelude 32 K Printer/Buffered	
	5-8	Parallel Buffer	
	5-9	College Nice Print	
6 Serial Interface ...	6-1	Communications	
	6-2	Serial	
	6-3	Asynchronous	
	6-4	Supra Serial	
	6-5	Super Serial Card	
7 Modem	7-1	K-Modem300	
	7-2	Modemcard	
	7-3	RS232/Modem	
8 Music/Voice .	8-1	Music Card 1)	
	8-2	Music Card 2)	2-card set
	8-3	Voice Machine	
	8-4	The Yapple	
	8-5	Music Machine	
	8-6	Three Voice Synthesizer	
	8-7	Instrument Synthesizer MK1)	
	8-8	Instrument Synthesizer MK2)	3-card
	8-9	Instrument Synthesizer)	set
		Computer Interface)	
	8-10	Talker I	
	8-11	6850 MIDI	
	8-12	Digital	
	8-13	Advanced 6850 MIDI	
9 Copy	9-1	Copycard	
	9-2	Snapshot	
	9-3	ROM Blaster	
	9-4	EPROM Programmer	
	9-5	AP-64 EPROM Writer	
	9-6	Super Burner	
	9-7	Excel Burner	

10 Miscellaneous	10-1	RGB
	10-2	Time
	10-3	Input/Output (PIA)
	10-4	Multifunction
	10-5	IEEE
	10-6	A/D-D/A
	10-7	K-Clock
	10-8	6522 VIA
	10-9	Pro-Time Clock
	10-10	Iie Multifunction
	10-11	Ace Dual I/O
11 Prototyping	11-1	Prototyping I
	11-2	Prototyping II
	11-3	Prototyping III
	11-4	Extend-A-Card
	11-5	EK Card Extender
	11-6	EK Prototyping
	11-7	JK Extender
	11-8	APL Prototyping

PART I

GUIDELINES TO SUCCESS

SAFETY

When cutting excessive wire leads from resistors, diodes, etc., protect your eyes. Wear safety glasses and keep the card at a reasonably safe distance. Turn your head to the side when trimming component leads.

Treat the soldering iron with respect. A hot iron can inflict a nasty burn. Do not touch the soldered connections before they have cooled down. Always rest the hot iron on a soldering stand when not in use. Turn the soldering iron off when you leave your work area.

Work in a well-ventilated area.

Observe all electrical and fire safety precautions.

There's less chance of an accident if your work area is clean and well organized.

USING THIS GUIDE

Examine the various assembly guides presented in this manual and select the card that you wish to build. Study the card in detail before mounting any components. Handle the card only by its edges, NEVER by its surface. Fingerprints may leave a fine film of oil on the solder pads and prevent the solder from making a solid joint. Clean both sides of the card with a special commercial cleaner or denatured alcohol (methyl alcohol) before soldering.

Visually inspect the card for breaks, shorts, etch-flaws, and irregularities in the lands (tracks). Illuminate the card from the solder side with a strong light. Examine the tracks for shorts and hair-line fractures. Pay special attention to the component side where the tracks will be covered over with sockets. You won't get a second chance to inspect these areas once hidden with components. Check the inner surface of the plated-thru holes; a shiny appearance indicates that they are, in fact, plated-thru. On the other hand, a dull appearance suggests a poorly-made circuit card. If flaws exist, either make the necessary repairs or return the card to the dealer.

Compare the silk-screening on the bare card to the silk-screening on the layout in the text. Record all differences. Check the parts list for availability and price. Mentally position each socket and electrical component and device in place before beginning the actual assembly.

Orientate the card so that the component side faces you and the edge-card contacts are at the LOWER RIGHT.

ALL COMPONENTS ARE MOUNTED ON THE COMPONENT SIDE
AND SOLDERED ON THE SOLDER SIDE

Study the precautions thoroughly (marked with an asterisk * in the guides) before you begin to assemble a circuit card.

Each one of the guides is complete and independent of the others in this manual.

Use the guide as a shopping list. Refer to Fig. 1, A Portion of an Assembly Guide. Check off each component purchased in the space provided on the guide. Circle the appropriate component placement number after it has been installed. Some peripheral cards have the silk-screened labels printed directly under socket placements making it impossible to know which integrated circuit (IC) to install. Refer to the component placement layout for IC positioning.

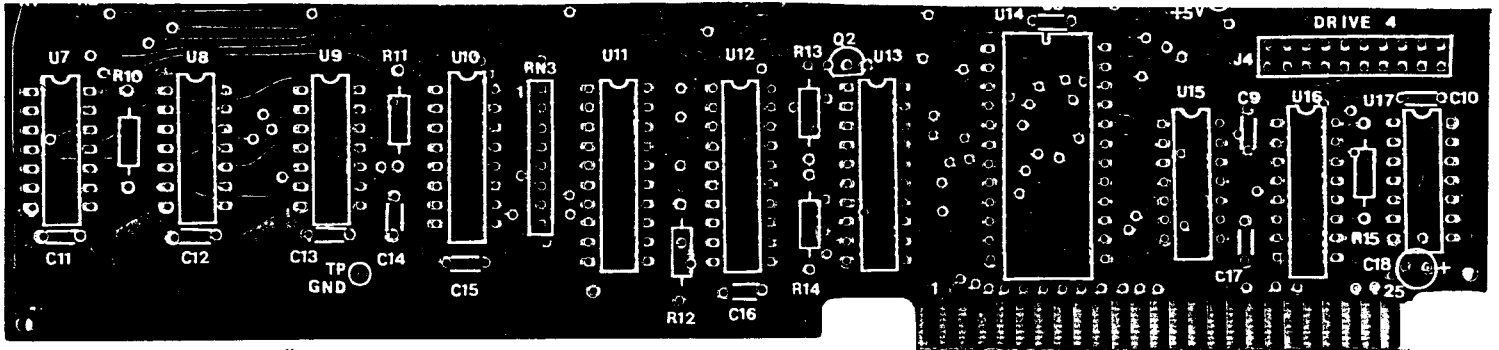

SEQUENCE *INDICATES A PRECAUTION

SEQUENCE	RESISTORS	R 1/4 watt, 5%
<u>2</u>	2 -	33 Ω @ R8,9
<u>1</u>	1 -	100 Ω @ R1
<u>1</u>	1 -	470 Ω @ R12
<u>4</u>	6 -	680 Ω @ R1,2,6,7,13,14
<u>✓</u>	1 -	4.7 KΩ @ R15
<u>✓</u>	1 -	47 KΩ @ R5
<u>✓</u>	1 -	1 MΩ @ R4
<u>??</u>	2 -	4S33 Ω SIP* (isolated) @ RN1,2
<u>1</u>	1 -	1.7 KΩ STD* (bussed) @ RN3

TRANSISTORS Q *Install the three EBC leads as shown

2 2 - 2N3906 @ Q1,2



DIODES D

2 3 - LED *Position longer lead (anode) of LEDs as shown @ CR1,2,3

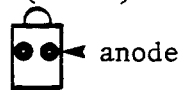

CONNECTORS

4 - 2x10 male header strip, straight

FIG. 1. A PORTION OF AN ASSEMBLY GUIDE.

The correct sequence of installing components is debatable. Try to keep all the components flush against the board. As a general rule, mount the components that are shortest in height first (diodes, resistors, sockets), followed by the taller components (capacitors, switches, resistor networks, etc.). This helps to keep the components tight against the board when soldering.

In some situations, it may be more practical to install sockets first. This may eliminate some confusion as to the placement of the smaller components, especially if the card is inadequately silk-screened or cluttered.

Component leads are NEVER inserted into FEED-THRU holes. On some of the cards illustrated, the FEED-THRU holes are smaller and can thus be distinguished from the larger COMPONENT holes.

The spacing between two solder holes on any one circuit card is often the same for each type of component. Thus resistor leads are bent to the same length. By-pass capacitors (0.1 μ F) have a smaller hole-to-hole spacing. This may help you to decide the mounting position of some of the components.

Use a low-wattage (less than 35 watts) soldering iron with a small pencil, pyramid, or screw-driver tip. Use only rosin-core, radio-type solder with a 60/40 or 63/37 tin/lead content. NEVER use acid-core solder! NEVER use a solder gun!

Take care with your soldering. The soldering iron TIP should make firm contact with the PIN or component lead and the solder PAD as illustrated in FIG. 2, Soldering Techniques. Apply solder to the opposite side of the pin touching both the pin and the pad. Follow this sequence:

IRON ON - SOLDER ON - SOLDER OFF - IRON OFF

Excessive heat may damage delicate components. If done correctly, soldering one pin or component lead should take no more than four to five seconds.

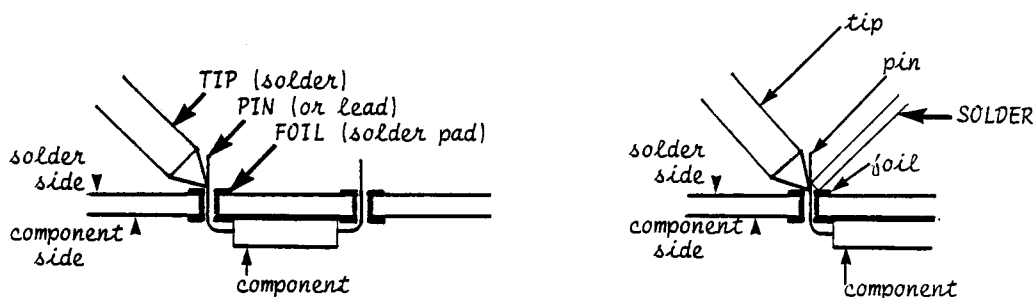

A. Three-Point Contact

B. Applying the Solder

FIG. 2. SOLDERING TECHNIQUES.

Some peripheral cards appear to have a preference for devices made by a specific manufacturer. The parts list shows this source in brackets following the device. Other devices that are followed by a manufacturer's name in brackets are made only by that manufacturer.

Some of the cards require modifications as illustrated in the MULTIFUNCTION CARD, GUIDE 10-4. Modifications are done on the solder side except where indicated. Study the details thoroughly before attempting any modifications.

Variations in silk-screening may be encountered in some of the circuit cards. Fig. 3 shows four variations of the 128 K RAMCARD. Compare these to the correctly silk-screened version in GUIDE 2-4. Component placement may be missing or incorrect. Integrated circuit pin number 1 may be turned thru 180°. Return these cards to the supplier. If, on the other hand, you do decide to assemble cards that are incorrectly silk-screened, work cautiously and systematically. Apply a small dab of typewriter correction fluid to mark and identify pin 1 of sockets and ICs.

GUIDE TO COMPONENTS

For a more detailed look at component identification and placement, and for installation techniques, refer to the "apple-seed: Motherboard Assembly Manual".

DIODES AND LIGHT EMITTING DIODES (D)

Diodes are delicate and can be easily damaged by rough handling and excess heat. These devices are polarized and must be correctly oriented on the circuit card. Position the banded (cathode) end of the diode towards the tip of the arrow as shown in following figure (Fig. 4).

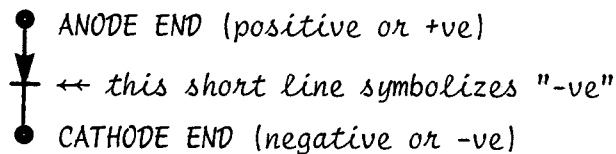

FIG. 4. IDENTIFYING THE CATHODE ON THE LAYOUT.

The polarity of light emitting diodes (LEDs) may be identified in one of the following ways:

- ve: a small "dot" on the body of the device
- ve: base of the device is "flat"
- +ve: the "longer" terminal or lead

INDUCTORS (L)

The numerical value of inductors (coils) may be colour-coded on the body of the device. This value, in microhenries (μH), can be determined using Table I, Resistor Colour Code Chart.

FIG. 3. VARIATIONS OF THE 128 K RAMCARD. Refer to GUIDE 2-4 for the CORRECT component placement. (Reduced in size).

VARIATION
I
INCORRECTLY
SILK-SCREENED

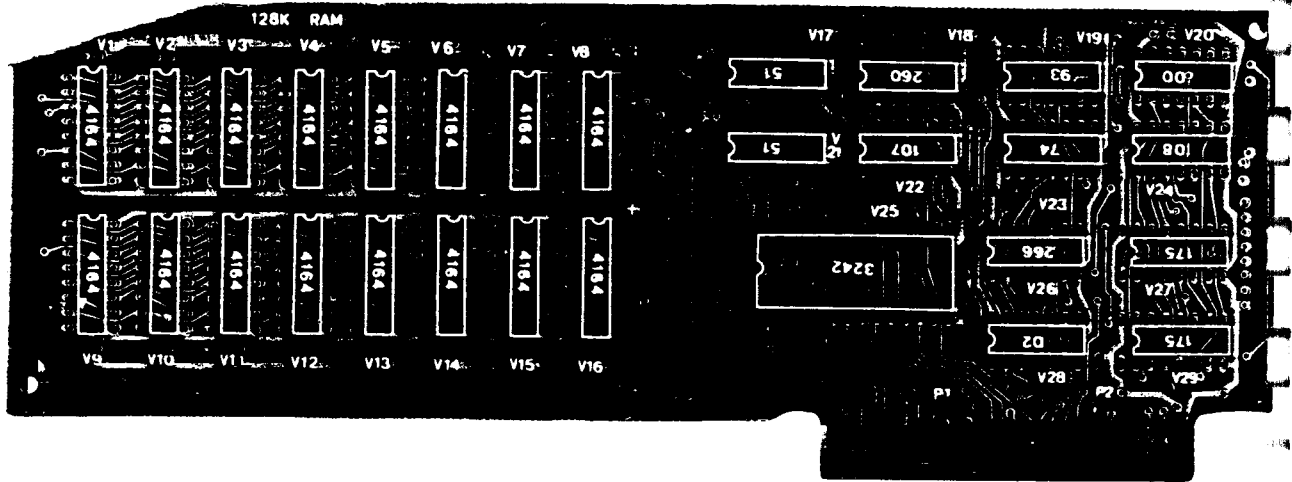

VARIATION
II
NOT
SILK-SCREENED

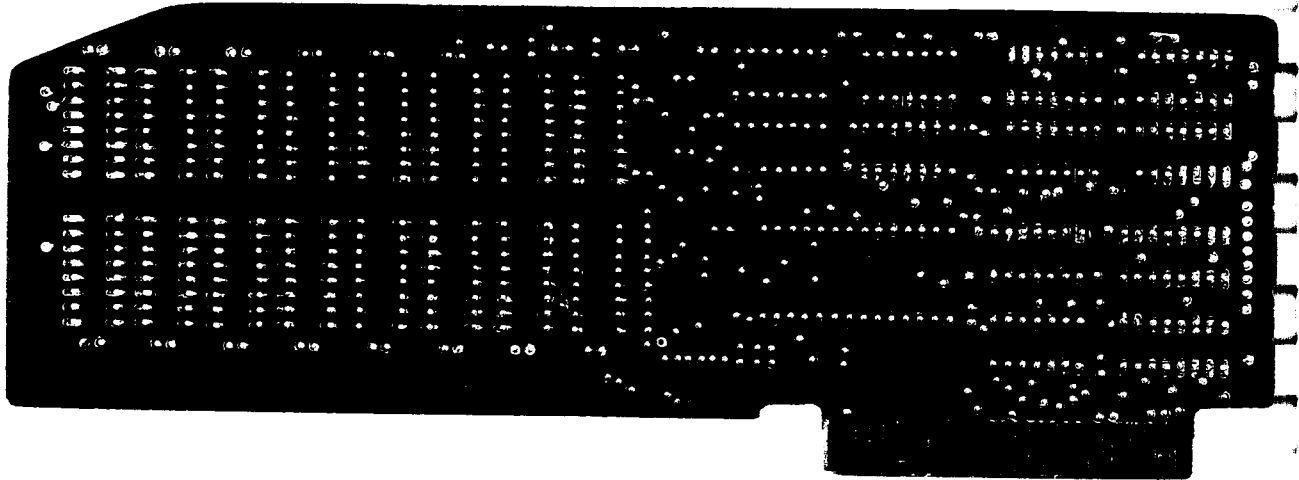

VARIATION
III
INCOMPLETELY
SILK-SCREENED

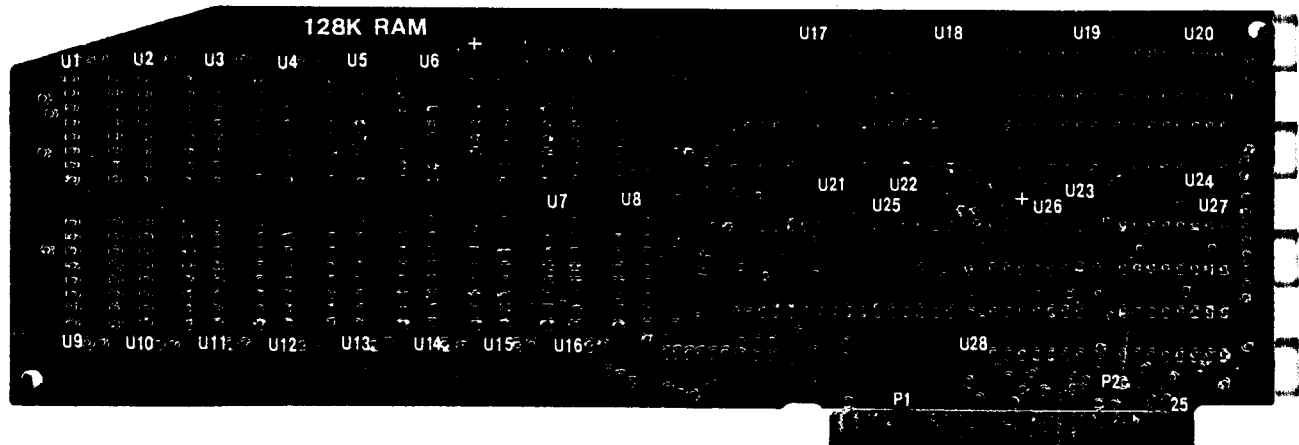

VARIATION
IV
INCORRECTLY
SILK-SCREENED

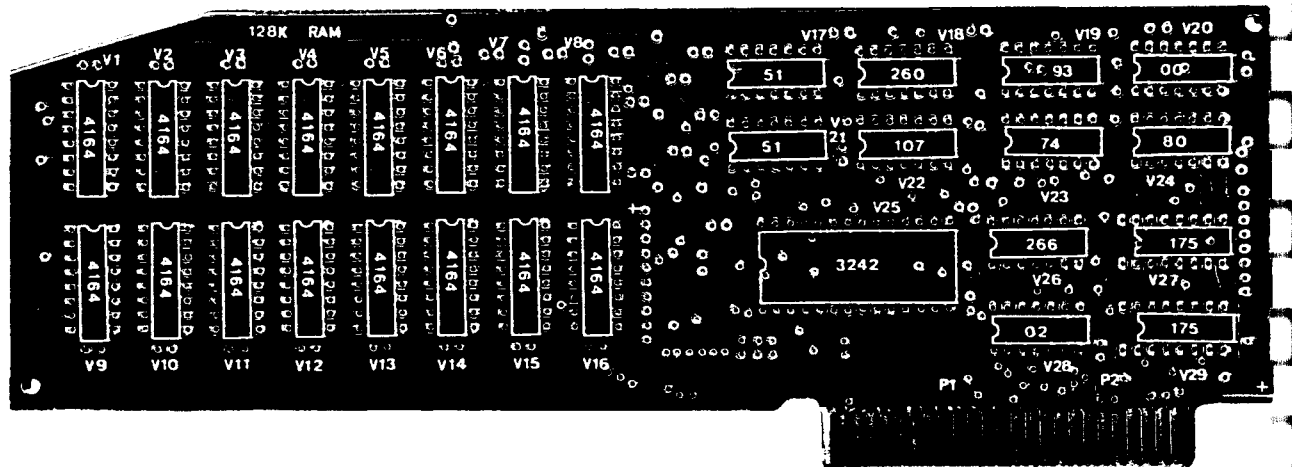

RESISTORS (R)

The resistors used to assemble the majority of peripheral cards illustrated in the manual are $\frac{1}{4}$ watt, with a tolerance of 5 percent (%). Refer to Table I, Resistor Colour Code Chart, to determine the ohms value of resistors.

Table I. Resistor Colour Code Chart.

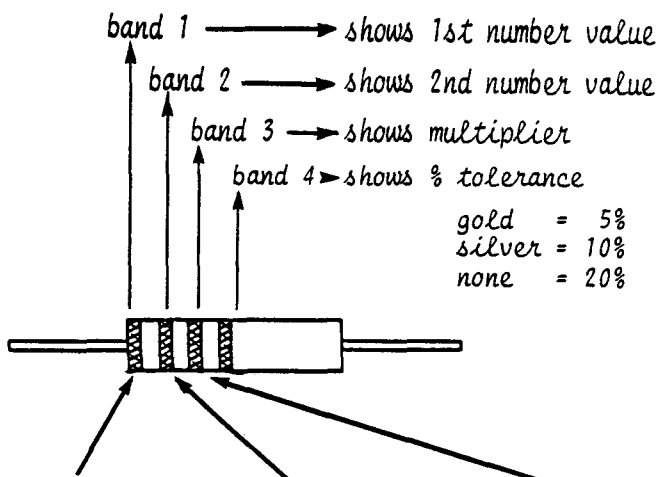

colour	1st digit	2nd digit	multiplier
black	0	0	1
brown	1	1	10
red	2	2	100
orange	3	3	1,000
yellow	4	4	10,000
green	5	5	100,000
blue	6	6	1,000,000
violet	7	7	10,000,000
gray	8	8	100,000,000
white	9	9	1,000,000,000
gold	-	-	0.1
silver	-	-	0.01

- EXAMPLES: a) yellow, red, black, refers to
 4 7 X1 = 47 Ω (ohms)
- b) brown, green, red, refers to
 1 5 X100 = 1,500 ohms or 1.5 K Ω (K = Kilo)

Do NOT attempt to remove a socket if it has been installed with pin 1 positioned incorrectly, i.e., socket turned thru 180°. Instead, apply a very small dab of typewriter correction fluid to the corner of the socket to identify pin number 1.

CAPACITORS (C)

Capacitors are either electrolytic (polarized) or non-electrolytic (non-polarized). Polarized capacitors must be connected in the circuit so that their positive and negative terminals are correctly positioned in the circuit. Match the +ve terminal of these capacitors with the +ve end as shown on the layout. Non-polarized capacitors have neither +ve nor -ve ends and may be installed in the circuit in any manner. Capacitors of values greater than 0.1 μF are generally polar. Refer to Table II for the capacitance and tolerance of capacitors.

Table II. Multiplier and Tolerance Chart for Capacitors.

MULTIPLIER		TOLERANCE		
for the number:	multiply by:	10 pF* or less	letter	over 10 pF
0	1	± 0.1 pF	B	-
1	10	± 0.25 pF	C	-
2	100	± 0.5 pF	D	-
3	1,000	± 1.0 pF	F	$\pm 1\%$
4	10,000	± 2.0 pF	G	$\pm 2\%$
5	100,000	-	H	$\pm 3\%$
-	-	-	J	$\pm 5\%$
8	0.01	-	K	$\pm 10\%$
9	0.1	-	M	$\pm 20\%$

*pF = picofarad

EXAMPLES: a) 221K printed on the device refers to a value of 22X10 = 220 pF with a tolerance of $\pm 10\%$

b) 104M refers to 10X10,000 or $10 \times 10^4 = 100,000$ pF or 0.1 μF , $\pm 20\%$

Voltage ratings, usually printed on the component, show how much voltage can safely be used without damaging the capacitor. The rating must be higher than the highest voltage in the circuit.

Install variable capacitors (trimmers or trimcaps) so that the common terminals of the device are aligned with the common solder pads on the card.

TRANSISTORS (Q)

Handle transistors with care. Protect them from mechanical injury. Use minimum heat when soldering. Transistors may be destroyed if their three leads are incorrectly positioned in the circuit. Identifying the emitter, collector, and base (EBC) terminals however, presents a problem: the body of the device may or may not be labelled; the circuit board may or may not be silk-screened; different manufacturers arrange the EBC leads differently. If in doubt, check with your dealer.

CRYSTALS (Y)

Crystals are delicate. A severe jolt may chip the crystal suspended in the metal case. Install crystals last to prevent excessive movement while working on other components. Fold the body of the device flat against the card before soldering if space is available on the card. Insulate the crystal from the card with two-way tape to prevent short circuits. Some of the cards have feed-thru holes at each side of the crystal so that the device can be secured in place. Refer to the MODEMCARD, GUIDE 7-2.

INTEGRATED CIRCUITS

Treat ICs with care. Handle them by the body, not the pins. Protect them from mechanical injury.

The power must be OFF when inserting or removing ICs or other devices. Excessive voltage, reversed polarity, short circuits, etc., can quickly destroy an IC. ICs must be correctly positioned in the circuit. Pin 1 of ICs can be identified by a "dot", a "triangle", a "1", a "notch", etc. Match pin 1 of ICs with pin 1 on the layout.

Metal-Oxide-Silicon (MOS) and Complementary Metal-Oxide-Silicon (CMOS) integrated circuits are very sensitive to static electrical discharge, and require special handling. Store them in their original shipping tubes or with their pins embedded in special conductive foam. Linear ICs are moderately sensitive, whereas Transistor-Transistor Logic (TTL) ICs are relatively insensitive to static discharge.

Difficulties in running some software programs may result when using RAM (Random-Access Memory) ICs of different speeds. Use 200 ns (nanosecond) RAM on both the motherboard and the peripheral cards, except where specified in the guide.

Keep EPROMs (Erasable Read-Only Memory) away from direct sunlight. Ultraviolet (UV) radiation of sunlight may partially erase some of the information programmed in an EPROM. Protect them by applying a non-transparent piece of tape or label over the transparent window on top of the device.

In some cases, it may be more convenient to use PROMs (Programmable Read-Only Memory) other than those specified in the guides. Refer to Table III, PROM Cross-Reference Chart, for appropriate substitutes. Firmware (software written into EPROMs or PROMs) is the responsibility of the builder and can be programmed according to the wishes of the individual.

Table III. PROM Cross Reference Chart Showing the Manufacturer and the Corresponding Part Number. *Are used in Guides.

HAR	MMI	NAT	SIG	T.I.
7603	6331	74S88	82S123*	18S030
-	6309*	74S471	-	28S22
7649*	6349*	74S472	82S147*	28S42
761I	6301	74S287	82S129*	28S10

HAR - Harris
 MMI - Monolithic Memories
 NAT - National Semiconductors
 SIG - Signetics
 T.I. - Texas Instruments

CARD INSTALLATION AND REMOVAL

DEDICATED SLOTS

Remove the cover of the computer. Locate the row of eight edge connectors on the motherboard. Refer to Fig. 6, Top View of Motherboard, for slot numbering. These conventions are generally followed by most users.

SLOT 0 - Memory (RAM or ROM) Card
 SLOT 1 - Printer Card
 SLOT 3 - 80-Column Card
 SLOT 6 - Disc Controller Card

CARD INSTALLATION

Turn the POWER OFF before installing or removing ANY peripheral card. Failure to do so will likely result in circuit damage to the card, other cards, and the motherboard.

Discharge STATIC ELECTRICITY in your body by touching the metal case of the power supply.

Orientate the peripheral card so that the SOLDER SIDE faces the power supply. Position the card carefully in the slot so that no "sliding" FRONT-TO-BACK movement occurs. This movement may strip the gold contacts from the card.

Insert the gold-plated fingers of the card into the appropriate connector. Gently rock the card from FRONT-TO-BACK while gently applying downward pressure. (Refer to Fig. 6 for the front-to-back orientation). The card must be firmly seated in the slot before turning on the power.

CARD REMOVAL

POWER OFF
DISCHARGE STATIC ELECTRICITY
ROCK FRONT-TO-BACK WHILE APPLYING UPWARD PRESSURE

PRECAUTIONS

Do NOT rock the card from side-to-side
Do NOT touch the gold-plated contact fingers of the card
Do NOT unnecessarily install and remove cards. Some poor-quality card-edge connectors may break down creating poor or non-existent contacts.
Do NOT apply excessive force. You may flex the motherboard sufficiently to break one or more of the tracks.

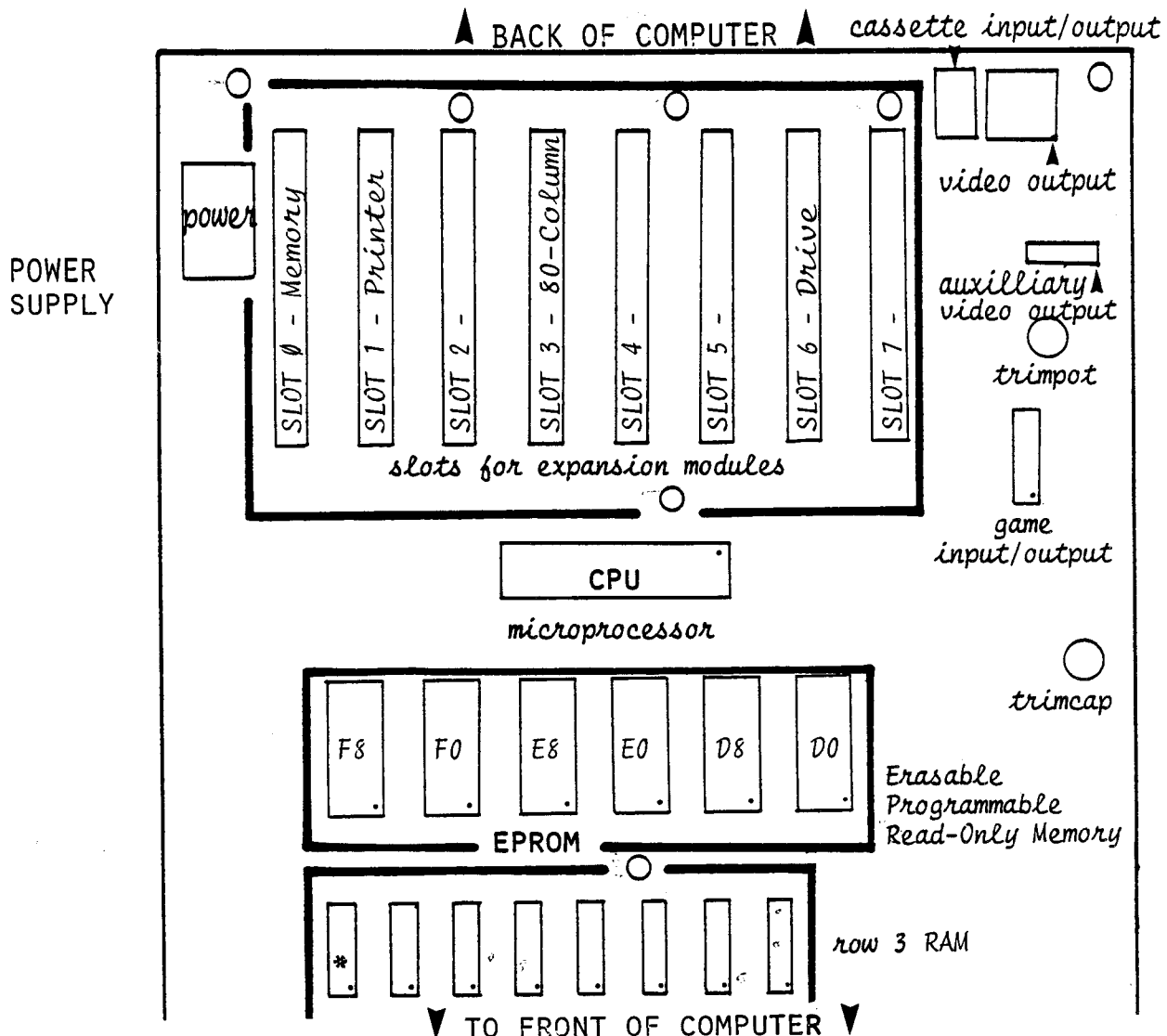

FIG. 6. A PORTION OF THE TOP VIEW OF THE MOTHERBOARD SHOWING FRONT-TO-BACK ORIENTATION AND DEDICATED SLOTS. Install ribbon cable from memory

CARD AND CONNECTOR PINOUT

Refer to Fig. 7 for the pinout for both the edge connector and the peripheral card. The reproductions are close to original size. To quickly identify any one of the pins or contacts, lay the card along the edge of the centre diagram and directly read off the pin number. Do NOT mistakenly interchange the component side with the solder side. Note the relative position of the power supply to the left of the motherboard.

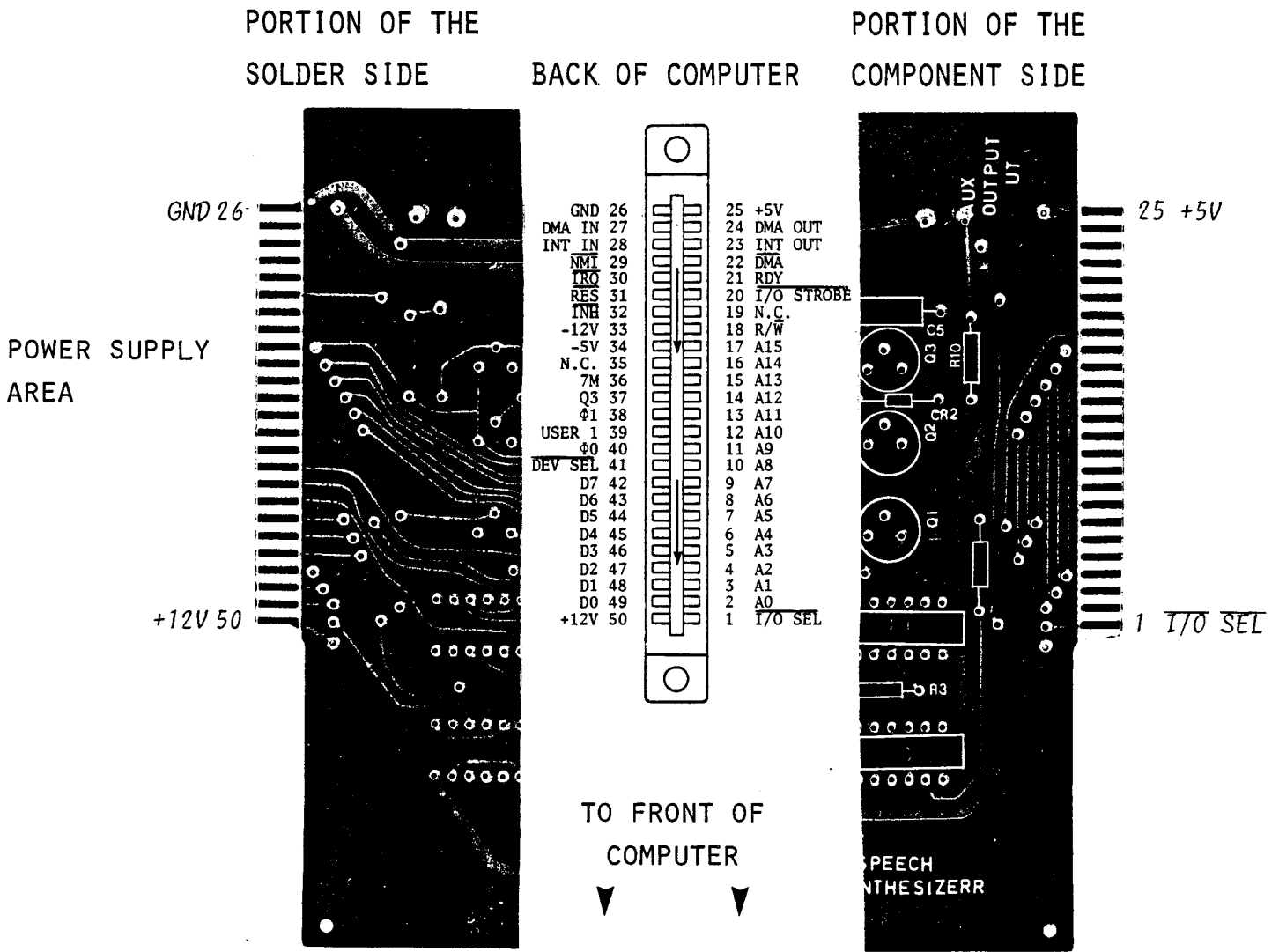

FIG. 7. PINOUT FOR THE EDGE CONNECTOR (CENTRE) AND BOTH SIDES OF THE PERIPHERAL CARD. Reproductions are close to original size.

APPENDIX

ABBREVIATIONS

Alt	- Alternate
B	- Base (Transistor)
BIT	- Binary digIT
BYTE	- a group of 8 BITS
C	- Collector (Transistor)
C	- letter code for Capacitor
CharGen	- Character Generator
CMOS	- Complementary Metal-Oxide-Silicon
Cont	- Controller
CP/M	- Control Program for Microprocessors
CPU	- Central Processing Unit
CRT	- Cathode Ray Tube
D	- letter code for Diode
DIN	- European type connector
DIP	- Dual In-line Package
D.C.	- Direct Current
DOS	- Disk Operating System
DRAM	- Dynamic RAM
DPDT	- Double-Pole, Double-Throw
DUART	- Dual Asynchronous Receiver Transmitter
E	- Emitter (Transistor)
EPROM	- Erasable PROM
FDC	- Floppy Disk Controller
FET	- Field Effect Transistor
GND	- Ground
HIRES	- High Resolution
Hz	- Hertz
IC	- Integrated Circuit
IEEE	- Institute of Electrical and Electronic Engineers
I/O	- Input/Output
J	- Jumper
K	- Kilobyte, 1,024 bytes
L	- letter code for Coil or Inductor
LED	- Light Emitting Diode
LPT	- Line PrinTer
M	- Megabyte, 1,024,000 bytes
MOS	- Metal-Oxide-Silicon
MPU	- Microprocessing Unit
-ve	- negative
NiCad	- Nickel Cadmium
ns	- nano second
+ve	- positive
P	- post
PAL	- Programmed Aray Logic
PC	- Printed Circuit
PCB	- Printed Circuit Board
PG	- Power Good

Q - letter code for Transistor
 R - letter code for Resistor
 R - Ring
 RAM - Random-Access Memory
 RF - Radio Frequency
 RGB - Red, Green, Blue
 RN - Resistor Network
 ROM - Read-Only Memory
 RTN - Return
 S - Schottky
 S, SW - Switch
 S, SPKR - Speaker
 SIP - Single In-line Package
 SPDP - Single-Pole, Double-Throw
 TP - Terminal Post
 Trimcap - Trim capacitor
 Trimpot - Trim potentiometer
 TTL - Transistor-Transistor Logic
 UV - Ultra Violet
 V - Volt
 Vid - Video
 VR - Variable Resistor
 XTAL - Crystal
 XTL - Crystal
 Y - letter code for Crystal
 ZIF - Zero Insertion Socket

METRIC PREFIXES Decimal points and large numbers are avoided.

p	pico	10^{-12}
n	nano	10^{-9}
μ	micro	10^{-6}
m	milli	10^{-3}
-	-	1.0^1
k	kilo	10^3
M	mega	10^6
G	giga	10^9

PART II

PERIPHERAL CIRCUIT CARD

ASSEMBLY GUIDES

Study PART I, GUIDELINES TO SUCCESS, before attempting to assemble any of the following peripheral cards.

GUIDE SB-1

MOTHERBOARD I: System board features: 6502 MPU; 48 K bytes of RAM expandable to 64 K and up with memory card(s); eight expansion slots for numerous peripherals; colour graphics capability; I/O ports. Requires firmware (six 716 EPROMs, or three 2732 EPROMs with modifications). Supports a variety of operating systems and programming languages.

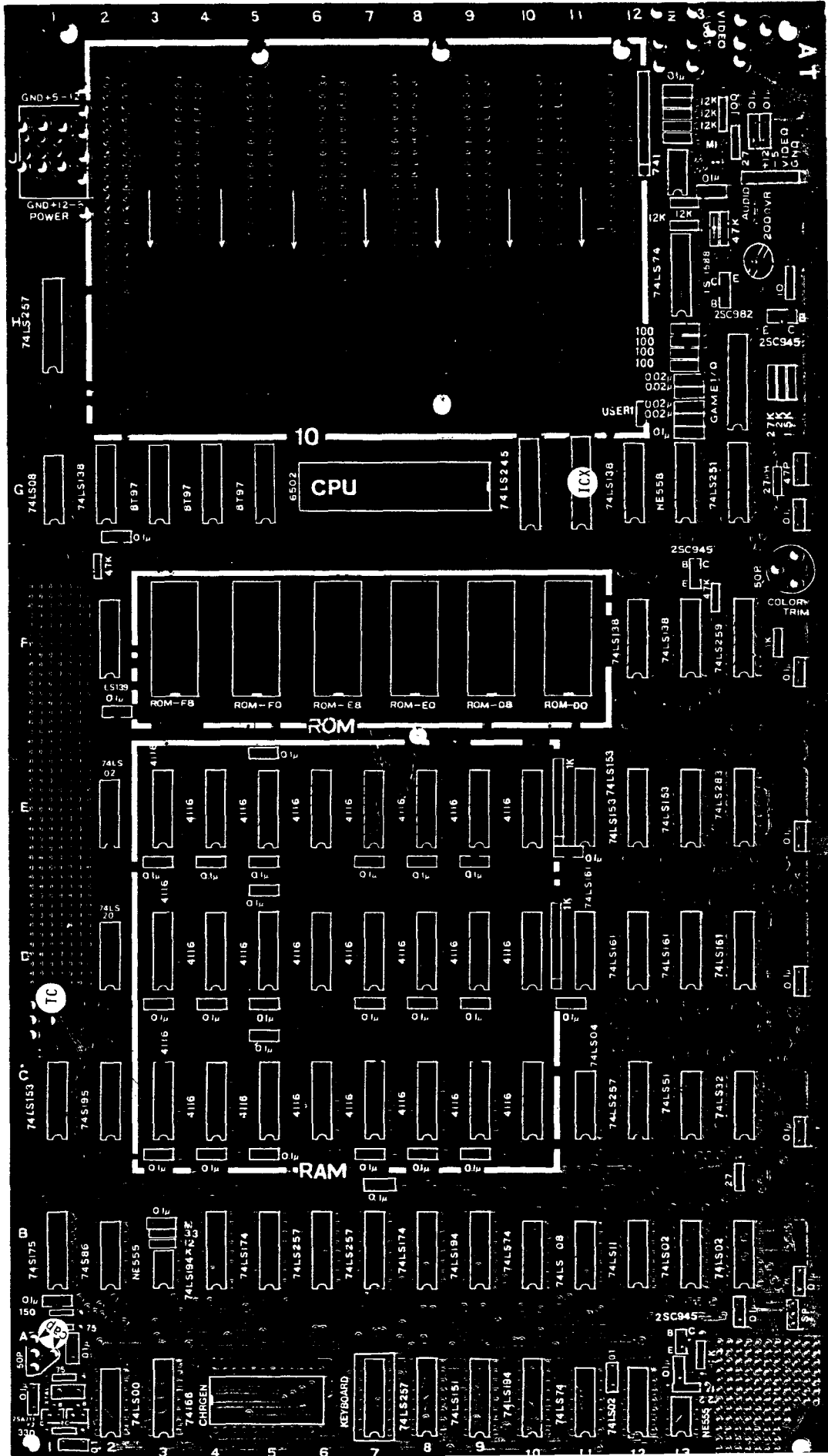

Layout is reduced. Actual size is 21.8 x 306.3 cm
 NB Install one 50 pF regular capacitor @ cap if colour is missing

MOTHERBOARD (continued) SUGGESTED SEQUENCE *INDICATES A PRECAUTION

- D *Position banded (cathode) end towards the arrow
 - 1N914
- RESISTORS
 - 1/4 watt, 5%
 - 10 Ω
 - 27 Ω
 - 47 Ω @ 75
 - 100 Ω
 - 150 Ω
 - 330 Ω
 - 1 KΩ
 - 1.5 KΩ
 - 2 KΩ
 - 2.7 KΩ
 - 4.7 KΩ
 - 12 KΩ
 - 47 KΩ
 - 1 MΩ
 - 2.2 MΩ
 - 3.3 MΩ
 - 1 KΩ 9-pin SIP* Match pin 1 of SIPs with pin 1 (square) on the layout
 - 200 Ω Trimpot
- TRANSISTORS Q *Match EBC transistor leads with EBC on the layout
 2 - 2N4258 or SA711 @ SA711
 3 - 2N3904 or SC945 @ SC945
 1 - MPSA13 or SC982 @ SC982
- CRYSTAL Y
 1 - 14.31818 MHz @ Xta1
- CONNECTORS
 1 - RCA video jack @ VIDEO
 2 - audio jacks @ OUT IN
 1 - 1x3 header, male, straight @ SP
 1 - 1x6 header, male, straight @ J-14
 1 - power plug @ POWER
 8 - 50-pin card edge connectors

INTEGRATED CIRCUITS *Match pin 1 of ICs with pin 1 on the layout

- 1 - 74LS00. *ICX is NOT equipped
 4 - 74LS02
 1 - 74LS04
 2 - 74LS08
 1 - 74LS11
 1 - 74LS20
 1 - 74LS32
 1 - 74LS51
 3 - 74LS74
 4 - 74LS138
 1 - 74LS139
 1 - 74LS151
 4 - 74LS153
 4 - 74LS161
 1 - 74166 @ 74LS166
 2 - 74LS174
 3 - 74LS194
 1 - 74S195 @ 74LS195
 1 - 74LS245
 1 - 74LS251
 5 - 74LS257
 1 - 74LS259
 1 - 74LS283
 3 - 74LS367 or 8T97

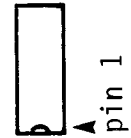

- TORS C
 - 47 pF
 - 0.02 μF
 - 0.1 μF Monolithic
 - 50 pF Trimcap @ TC

*Refer to note on previous page

- INTEGRATED CIRCUITS (continued)
 1 - 74S86
 1 - 74S175
 2 - NE555
 1 - NE558
 1 - 741
 1 - 6502 CPU
 7 - 2716 EPROMs @ ROMs & CHRGEN
 24 - 4116 dynamic RAMs 200 ns or faster

MISCELLANEOUS

- 1 - ASCII Keyboard
 1 - switching power supply
 1 - case

MODIFICATION on COMPONENT SIDE to use 2732 EPROMs in place of 2716 EPROMs - Refer to the following layout:

- A Cut "bow-tie" @ X
 B Jumper "half-moons" @ Y
 C Jumper the two feed-tru holes @ Z

Install three 2732 EPROMs @ ROM-F0, E0, D0

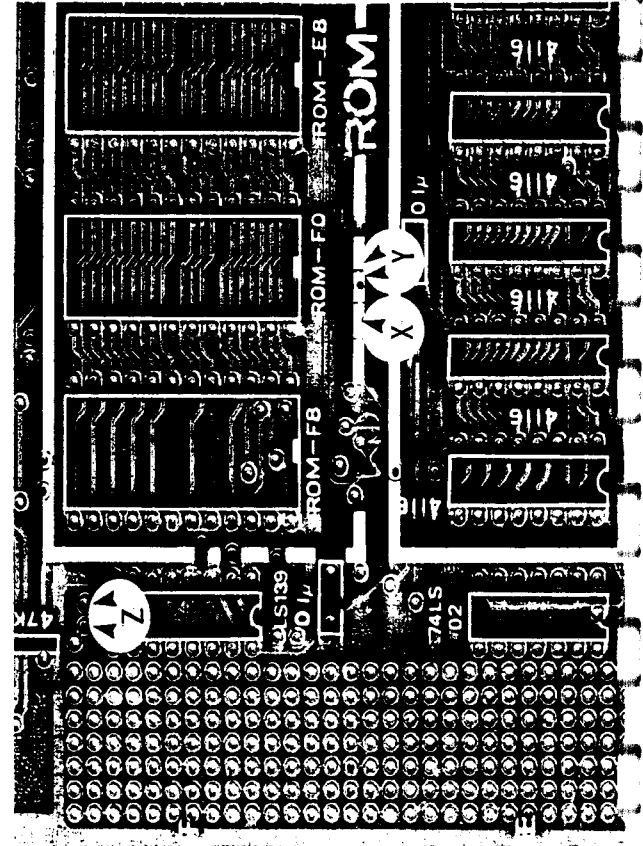

GUIDE SB-2

MOTHERBOARD II: System board-2 features: 6502 MPU; 48 K bytes of RAM expandable to 64 K and beyond with memory board(s); eight expansion slots for numerous peripherals; colour graphics capability; I/O ports. Requires firmware (one cut on the solder side). Supports a variety of operating systems and programming languages.

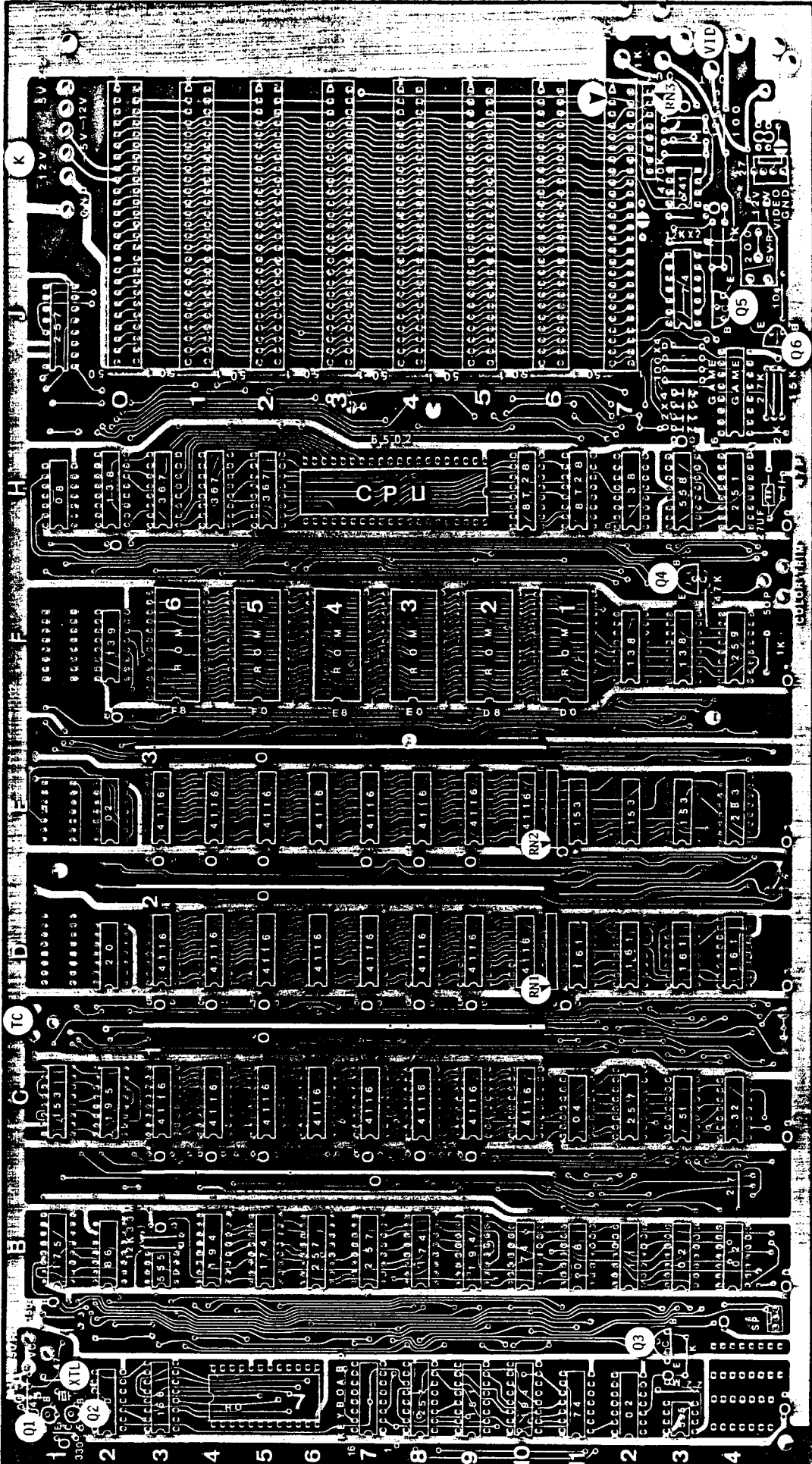

Layout is reduced. Actual size is 21.9 x 307.3 cm

HERBOARD II (continued) SUGGESTED SEQUENCE *INDICATES A PRECAUTION *NOTE MODIFICATIONS

*Position banded (cathode) end of diode towards the arrow

- IN914
- RES R 1/4 watt, 5% @ 
- 10 Ω
- 27 Ω
- 47 Ω
- 100 Ω
- 150 Ω
- 330 Ω
- 1 KΩ
- 1.5 KΩ @ 15K
- 2 KΩ
- 2.7 KΩ @ 27K
- 4.7 KΩ @ 47K
- 12 KΩ
- 470 KΩ
- 2.2 MΩ @ 22M
- 3.3 MΩ @ 33M
- 1 KΩ 8-pin SIP* bussed @ RN1,2,3
- *Match pin 1 of SIPs with pin 1 (arrow) on the layout
- 200 Ω Trimpot @ SV-R
- 27 or 33 μH @ 27 μF

*Match pin 1 of sockets with pin on the layout. Check that ALL pins have passed thru ALL holes

- 8-pin
- 14-pin
- 16-pin
- 24-pin
- 40-pin

RESORS C

- 47 pF @ 47P
- 0.02 μF @ 02x4
- 0.1 μF @ 
- 50 pF Trimcap @ TC

TRANSISTORS Q *Match EBC transistor leads with the EBC leads on the layout

- 2 - 2N4258 @ Q1,2
- 3 - 2N3904 @ Q3,4,6
- 1 - MPSA13 @ Q5

CRYSTAL Y *Solder case of crystal to ground

- 1 - 14.31818 MHz @ XTL

CONNECTORS

- 1 - RCA video jack @ VID
- 2 - audio jacks @ IN OUT
- 1 - 1x3 header, straight, male @ SP
- 1 - 1x4 header, straight, male @ K-14
- 1 - power plug @ K-1
- 8 - 50-pin card edge connector*
 - *CHECK possible point for short on slot 7 (K-12) as follows: trace from pin 24 between pins 26 & 27 as shown on layout on COMPONENT SIDE

INTEGRATED CIRCUITS *Match pin 1 of ICs with pin 1 on the layout

- 1 - 74LS00
- 4 - 74LS02
- 1 - 74LS04
- 2 - 74LS08
- 1 - 74LS11
- 1 - 74LS20
- 1 - 74LS32
- 1 - 74LS51
- 3 - 74LS74
- 4 - 74LS138
- 1 - 74LS139
- 1 - 74LS151
- 4 - 74LS153
- 4 - 74LS161
- 2 - 74LS174
- 3 - 74LS194
- 1 - 74LS251

INTEGRATED CIRCUITS *NOTE MODIFICATIONS

- 5 - 74LS257
- 1 - 74LS259
- 1 - 74LS283
- 3 - 74LS367 or 8T97
- 1 - 74S86 @ 86
- 1 - 74S175 @ 175
- 1 - 74S195 @ 195
- 1 - 74166 @ 166
- 2 - 8T28
- 2 - NE555
- 1 - NE558
- 1 - 741
- 1 - 6502 CPU
- 7 - 2716 EPROMs @ ROM 1,2,3,4, ROM 5,6,7
- 24 - 4116 dynamic RAM 200 ns or faster

*MODIFICATION REQUIRED ON SOLDER SIDE @ A-5,6 as shown below:
Cut trace from pin 9 of ROM 7 to line leading from pin 22 of ROM 7

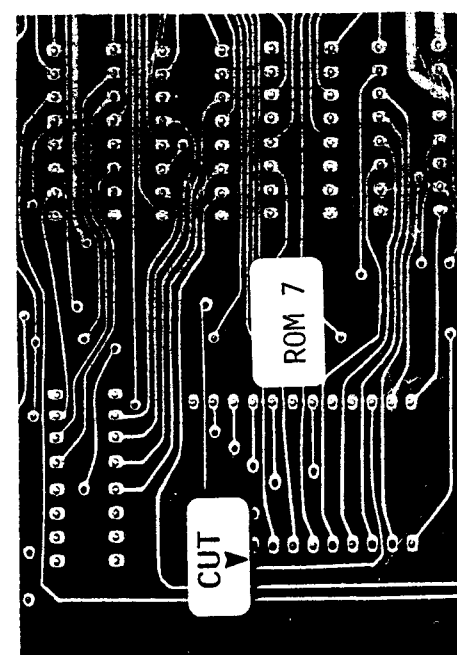

GUIDE SBe-1

CON 6502B/65C02 MOTHERBOARD: System Board features include: 6502B or 65C02 MPU; eight expansion slots for numerous peripherals (one 60-pin auxiliary slot and seven 50-pin slots); colour graphics capability; I/O ports. Requires modifications (four cuts on the component side), firmware (one 2716, one 2732 and two 2764 EPROMs), and three specialized ICs.

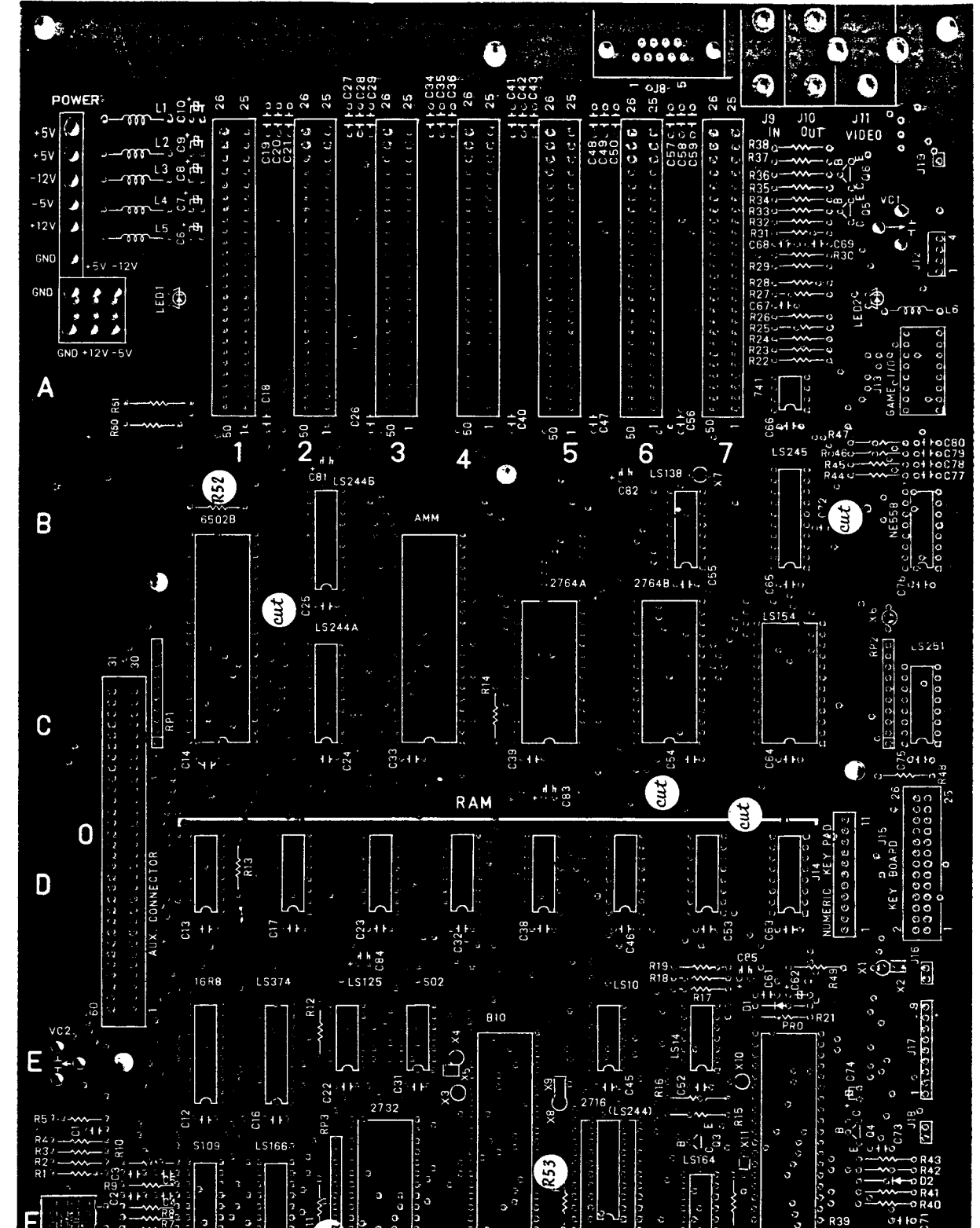

actual size
29.2 cm x 22.2 cm
(layout is reduced)



NuScope Associates

IRON 6502B/65C02 MOTHERBOARD (continued) *INDICATES A PRECAUTION

ES D *Position banded (cathode) end of diode towards the arrow
 2 - 1N914 @ D1,2

ISTORS R ¼ watt, 5% *R51 is 1 watt

*R20 is not equipped

3 - 47 Ω @ R5,13,14

1 - 51 Ω @ R4

2 - 75 Ω @ R38,40

7 - 100 Ω @ R27,36,37,44,45,46,47

1 - 100* Ω @ R51* 1 watt

5 - 120 Ω @ R1,6,8,9,10

1 - 150 Ω @ R2

2 - 200 Ω @ R41,50

1 - 270 Ω @ R3

1 - 330 Ω @ R31

2 - 470 Ω @ R43,48

6 - 1 KΩ @ R7,11,12,29,35,52

1 - 2.7 KΩ @ R30

2 - 4.7 KΩ @ R16,53

1 - 5.6 KΩ @ R33

2 - 6.8 KΩ @ R32,34

4 - 10 KΩ @ R17,18,19,21

5 - 12 KΩ @ R22,24,25,26,28

1 - 22 KΩ @ R15

1 - 47 KΩ @ R49

1 - 51 KΩ @ R42

1 - 100 KΩ @ R39

1 - 1 MΩ @ R23

Match pin 1 of the following SIPS (bussed) with pin 1 (square pad) on the layout

1 - 1 KΩ 10-pin SIP @ RP2

2 - 3.3 KΩ 10-pin SIP @ RP1,3

SETS *Match pin 1 of sockets with pin 1 on the layout. Check that ALL pins have passed thru ALL holes

1 - 8-pin

SOCKETS (continued)

5 - 14-pin

14 - 16-pin

3 - 20-pin

5 - 24-pin

2 - 28-pin

4 - 40-pin

CAPACITORS C

2 - 47 pF @ C69,70

1 - 50 pF @ C21a @ Location F-3

1 - 100 pF @ C68

4 - 220 pF @ C2,3,4,5

5 - 0.022 F @ C61,77,78,79,80

61 - 0.1 μF Monolithic @ C1,11 to 60, @ C63,64,65,66,67,71,72, @ C73,75,76

12 - 10 μF/16V Tantalum* @ C6,7,8,9, @ C10,62,74,81,82,83,84,85

*Match + of Tantalums with + on the layout

2 50 pF Trimcap @ VC1,2

TRANSISTORS Q *Match EBC transistor leads with EBC on the layout

2 - 2N3904 @ Q3,6

3 - 2N3906 @ Q1,2,5

1 - MPSA13 @ Q4

CRYSTAL Y *Fold crystal flat against the board before soldering.

1 - 14.31818 MHZ @ XTAL1

COIL (CHOKE) L

1 - 27 μH @ L6

5 - Ferrite bead*, four-hole @ L1,2,3, @ L4,5

*Not critical - hook-up wire may be substituted at each location

LIGHT EMITTING DIODES D *Position flat part or shorter lead of LED towards the arrow on layout

2 - LED @ LED1,2

HEADERS male, straight

1 - 1x4 @ J12 RF converter

1 - 1x11 @ J14 Num keypad

1 - 2x13 @ J15 Keyboard

1 - 1x2 @ J16

1 - 1x9 @ J17

1 - 1x2 @ J18 Speaker

1 - 1x1 @ J19 Video out

CONNECTORS

1 - 6-pin power @ POWER

1 - DE9S female, 90° @ J8

2 - Audio jacks @ J9,10

1 - RCA phono jack @ J11

1 - 60-pin card edge connector @ J

7 - 50-pin card edge connector @ 1,2,3,4,5,6,7

INTEGRATED CIRCUITS *Match pin 1 of ICs with pin 1 on the layout

1 - 74LS14 @ Location E-9

1 - 74LS10 @ E-8

1 - 74LS125 @ E-3

1 - 74LS138 @ B-9

1 - 74LS154 @ C-10

1 - 74LS164 @ F-9

1 - 74LS166 @ F-2

2 - 74LS244 @ B-3, C-3

1 - 74LS245 @ B-10

1 - 74LS251 @ C-11

1 - 74LS374 @ E-2

1 - 74S02 @ E-4

1 - 74S109 @ F-1

1 - NE558 @ B-11

1 - 741 @ A-10

BELTRON 6502B/65C02 MOTHERBOARD (continued)

INTEGRATED CIRCUITS (continued)

- 1 - 6502B MPU (or 65C02) @ BC-1
- 1 - 2716 EPROM @ F-8
- 1 - 2732 EPROM @ F-4
- 1 - 2764 EPROM @ C-7
- 1 - 2764 EPROM @ C-9
- 8 - 4164 RAM 200 ns @ Row D
- 1 - AY5-3600-PRO @ EF-10

CUSTOM INTEGRATED CIRCUITS

- 1 - STK65371 (or STK50371) @ BC-4
- 1 - STK65301 @ EF-6
- 1 - 16R8 PAL @ E-1

*MODIFICATIONS: Make four cuts on the COMPONENT SIDE as shown on the following layout:

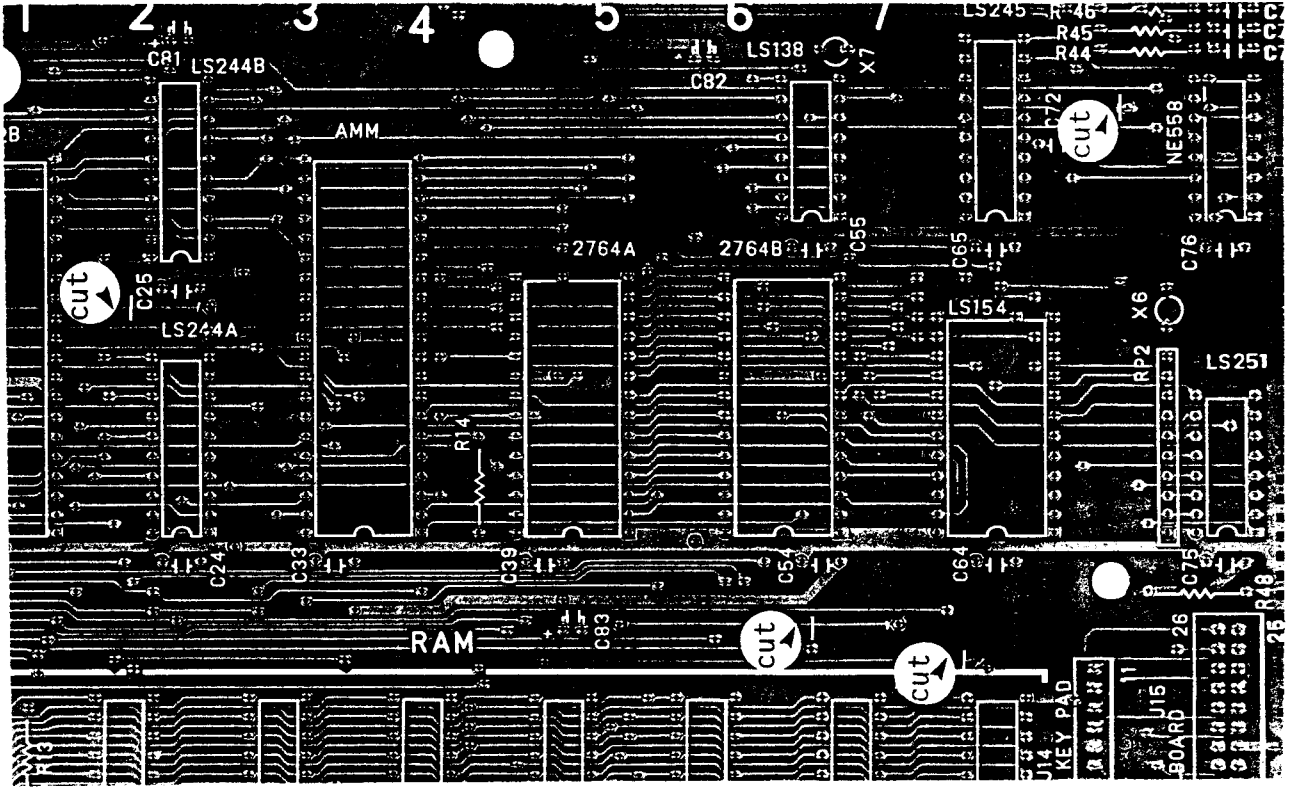

GUIDE SBe-2

JK 6502B/65C02 MOTHERBOARD: System board features include: 6502B or 65C02 MPU; 64 K of RAM expandable via the auxiliary slot; eight expansion slots for numerous peripherals (one 60-pin & seven 50-pin slots); colour graphics capability; I/O ports. Requires firmware (one 2716, one 2732 & two 2764 EPROMs), & three specialized ICs. Supports various operating systems and programming languages. Requires modifications.

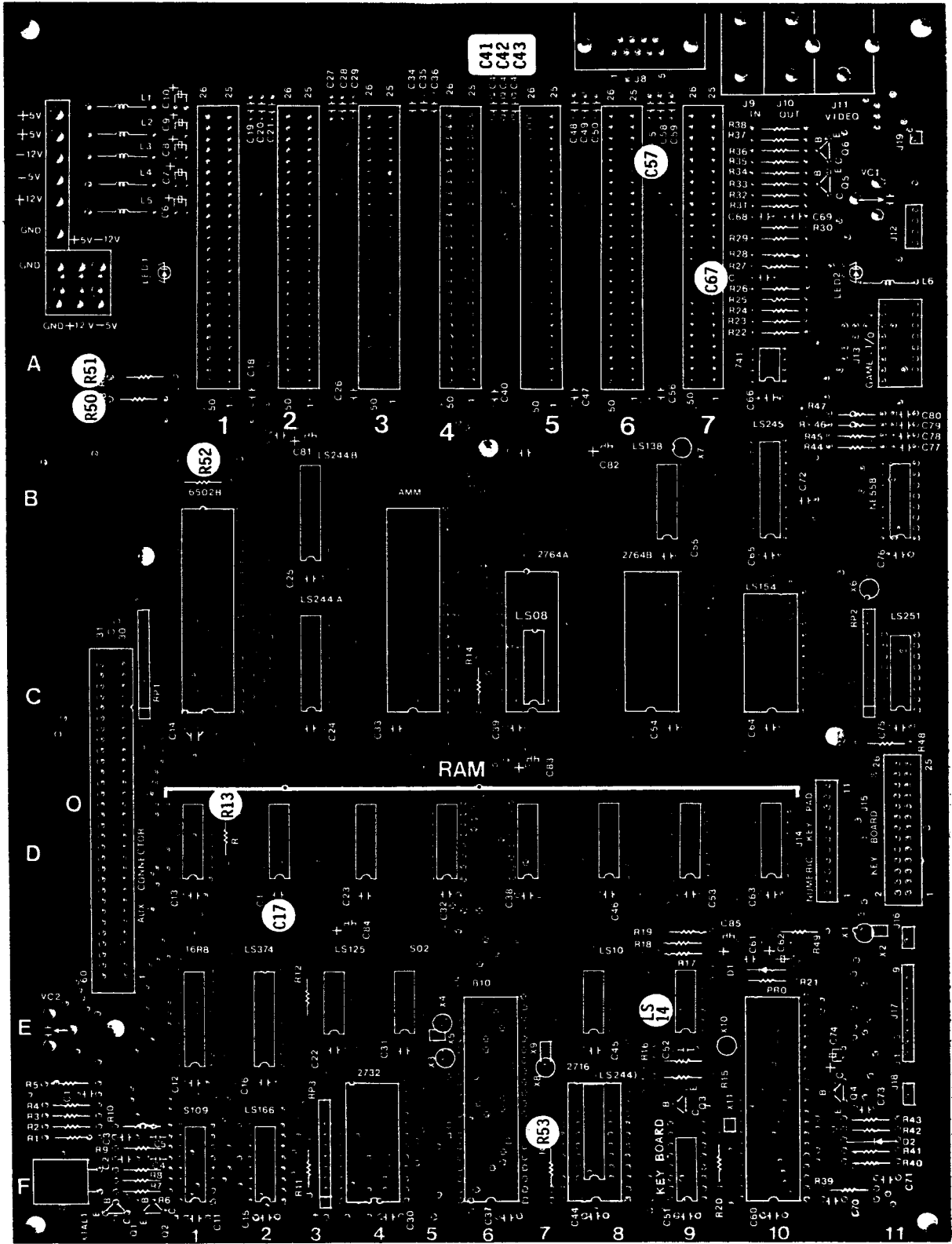

actual size
29.2 cm x 22.2 cm
(layout is reduced)

74B/65C02 MOTHERBOARD:

(continued) *INDICATES A PRECAUTION

- D *Position banded (cathode) end diode towards the arrow
- 1N914 @ D1,2
- RS R 1/4 watt, 5% *R51 is 1 watt
- 20 is not equipped
- 47 Ω @ R5,13,14
- 51 Ω @ R4
- 75 Ω @ R38,40
- 100 Ω @ R27,36,37,44,45,46,47
- 100* Ω @ R51* 1 watt
- 120 Ω @ R1,6,8,9,10
- 150 Ω @ R2
- 200 Ω @ R41,50
- 270 Ω @ R3
- 330 Ω @ R31
- 470 Ω @ R43,48
- 1 KΩ @ R7,11,12,29,35,52
- 2.7 KΩ @ R30
- 4.7 KΩ @ R16,53
- 5.6 KΩ @ R33
- 6.8 KΩ @ R32,34
- 10 KΩ @ R17,18,19,21
- 12 KΩ @ R22,24,25,26,28
- 22 KΩ @ R15
- 47 KΩ @ R49
- 51 KΩ @ R42
- 100 KΩ @ R39
- 1 MΩ @ R23

SOCKETS (continued)

- 5 - 14-pin
- 14 - 16-pin
- 3 - 20-pin
- 5 - 24-pin
- 2 - 28-pin
- 4 - 40-pin

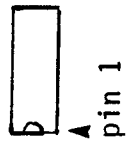

CAPACITORS C

- 2 - 47 pF @ C69,70
- 1 - 100 pF @ C68
- 4 - 220 pF @ C2,3,4,5
- 5 - 0.022 μF @ C61,77,78,79,80
- 61 - 0.1 μF Monolithic @ C1,11 to 60, @ C63,64,65,66,67,71,72, @ C73,75,76
- 12 - 10 μF/16V Tantalum* @ C6,7,8,9, @ C10,62,74,81,82,83,84,85
- *Match + of Tantalums with + on the layout
- 2 50 pF Trimcap @ VC1,2

TRANSISTORS Q *Match EBC transistor leads with EBC on the layout

- 2 - 2N3904 @ Q3,6
- 3 - 2N3906 @ Q1,2,5
- 1 - MPSA13 @ Q4

CRYSTAL Y *Fold crystal flat against the board before soldering.

- 1 - 14.31818 MHz @ XTAL1

COIL (CHOKE) L

- 1 - 27 μH @ L6
- 5 - Ferrite bead*, four-hole @ L1,2,3, @ L4,5
- *Not critical - hook-up wire may be substituted at each location

pin 1 of the following SIPs (pressed) with pin 1 (square pad) the layout

- 1 KΩ 10-pin SIP @ RP2
- 4.7 KΩ 10-pin SIP @ RP1,3

*Match pin 1 of sockets with pin 1 on the layout. Check that pins have passed thru ALL holes 8-pin

LIGHT EMITTING DIODES D *Position flat part or shorter lead of LED towards the arrow on layout

- 2 - LED @ LED1,2

HEADERS male, straight

- 1 - 1x4 @ J12 RF converter
- 1 - 1x11 @ J14 Num keypad
- 1 - 2x13 @ J15 Keyboard
- 1 - 1x2 @ J16
- 1 - 1x9 @ J17
- 1 - 1x2 @ J18 Speaker
- 1 - 1x1 @ J19 Video out

CONNECTORS

- 1 - 6-pin power @ POWER
- 1 - DE9S female, 90° @ J8
- 2 - Audio jacks @ J9,10
- 1 - RCA phono jack @ J11
- 1 - 60-pin card edge connector @ Ø
- 7 - 50-pin card edge connector @ 1,2,3,4,5,6,7

INTEGRATED CIRCUITS *Match pin 1 of ICs with pin 1 on the layout

- 1 - 74LS14 @ Location E-9
- 1 - 74LS10 @ E-8
- 1 - 74LS125 @ E-3
- 1 - 74LS138 @ B-9
- 1 - 74LS154 @ C-10
- 1 - 74LS166 @ F-2
- 2 - 74LS244 @ B-3, C-3
- 1 - 74LS245 @ B-10
- 1 - 74LS251 @ C-11
- 1 - 74LS374 @ E-2
- 1 - 74S02 @ E-4
- 1 - 74S109 @ F-1
- 1 - NE558 @ B-11
- 1 - 741 @ A-10

6502B/65C02 MOTHERBOARD (continued)

INTEGRATED CIRCUITS (continued)

- 1 - 6502B MPU (or 65C02) @ BC-1
- 1 - 2716 EPROM @ F-8 *74LS244 NOT required @ F-8
- 1 - 2732 EPROM @ F-4
- 1 - 2764 EPEOM @ C-7
- 1 - 2764 EPEOM @ C-9 *74LS08 NOT required @ C-9
- 8 - 4164 RAM 200 ns @ Row D
- 1 - AY5-3600-PRO @ EF-10

OPTIONAL INTEGRATED CIRCUITS

- 1 - STK65371 (or STK50371) @ BC-4
- 1 - STK65301 @ EF-6
- 1 - 16R8 PAL @ E-1

NOTIFICATIONS

- - cut split circle open @ X10 (E-10)
- - cut bowtie open @ X11 (E-10)

SURF BOARD MOTHERBOARD

◀ on-board 64 K RAM ▶

◀ on-board disc drive controller ▶

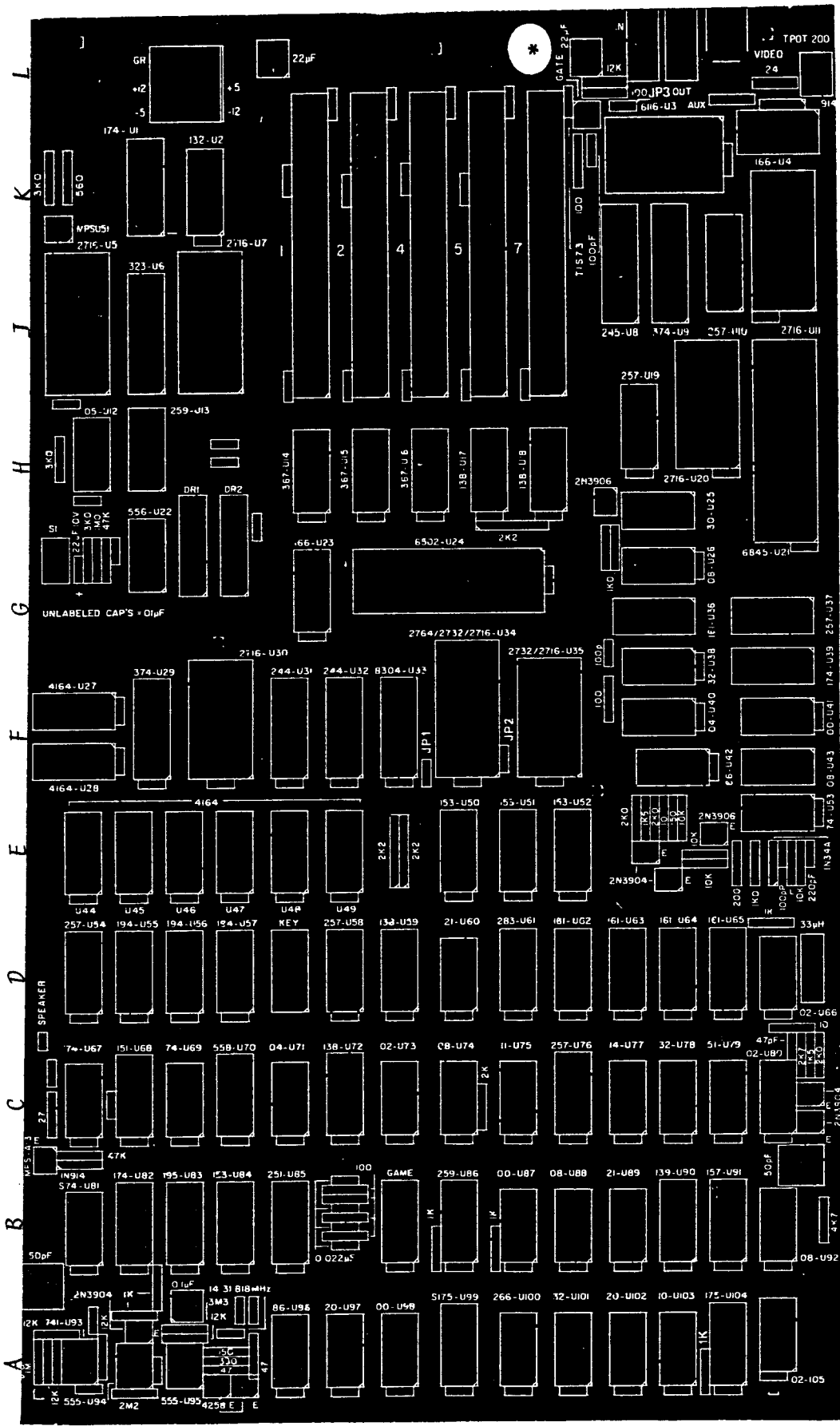

◀ on-board 80-column ▶

A Fig. 2-16. A COPY OF THE COMPONENT SIDE OF THE SURF-BOARD PCB (REDUCED IN SIZE) SHOWING THE COMPONENT LAYOUT. SOME OF THE UNIQUE FEATURES OF THE SURF-BOARD NOT NORMALLY FOUND ON OTHER SIMILAR PERSONAL COMPUTERS INCLUDE: 64 K BYTES OF USER MEMORY, DUAL DISC DRIVE CONTROLLER; 80-COLUMN TEXT DISPLAY WITH UPPER/LOWER CASE, AS WELL AS HIGH/LOW RESOLUTION COLOUR GRAPHICS, FIVE EXPANSION SLOTS, CASSETTE AND JOYSTICK IN/OUTPUTS, ETC.

*The "GATE" of the T1S73 FET transistor is INCORRECTLY silk-screened on the motherboard. Refer to FIG. 5-2, B for correct installation.

B SURF-BOARD PARTS LIST

RESISTORS R, 1/2 watt, 5%

_____ 2 - 10 Ω
 _____ 1 - 24 Ω
 _____ 1 - 27 Ω
 _____ 2 - 47 Ω
 _____ 7 - 100 Ω
 _____ 2 - 150 Ω
 _____ 1 - 200 Ω
 _____ 1 - 330 Ω

_____ 1 - 560 Ω
 _____ 9 - 1 K Ω
 _____ 2 - 1.5 K Ω
 _____ 4 - 2 K Ω
 _____ 1 - 2.7 K Ω
 _____ 3 - 3 K Ω
 _____ 1 - 4.7 K Ω
 _____ 5 - 10 K Ω

_____ 6 - 12 K Ω
 _____ 2 - 47 K Ω
 _____ 2 - 1 M Ω
 _____ 1 - 2.2 M Ω
 _____ 1 - 3.3 M Ω
 _____ 3 - 2.2 K Ω x 8 SIP
 _____ 1 - 200 Ω Trimpot

DIODES D

_____ 2 - IN914
 _____ 1 - IN34A or IN27C

COIL L

_____ 1 - 33 μ H

CRYSTAL Y

_____ 1 - 14.31818 MHz

CAPACITORS C

_____ 1 - 47 pF
 _____ 3 - 100 pF
 _____ 1 - 220 pF
 _____ 16 - 0.1 μ F
 _____ 3 - 22 μ F Tantalum
 _____ 2 - 50 pF Trimcap
 _____ 4 - 0.02 μ F/10v Tantalum

TRANSISTORS Q

_____ 5 - 2N3904
 _____ 2 - 2N3906
 _____ 2 - 2N4258
 _____ 1 - MPSA13
 _____ 1 - MPSU51
 _____ 1 - TIS73 (FET)

SOCKETS

_____ 3 - 8-pin
 _____ 36 - 14-pin
 _____ 51 - 16-pin
 _____ 7 - 20-pin
 _____ 7 - 24-pin
 _____ 1 - 28-pin
 _____ 2 - 40-pin

INTEGRATED CIRCUITS IC

TTL 74LSxxx ICs

_____ 3 - 74LS00 @ U41,87,98
 _____ 4 - 74LS02 @ U66,73,105,
 U80
 _____ 2 - 74LS04 @ U40,71
 _____ 1 - 74LS05 @ U12
 _____ 5 - 74LS08 @ U26,43,74,
 U88,92
 _____ 1 - 74LS10 @ U103
 _____ 1 - 74LS11 @ U75
 _____ 1 - 74LS14 @ U77
 _____ 2 - 74LS20 @ U97,102
 _____ 2 - 74LS21 @ U60,89
 _____ 1 - 74LS30 @ U25
 _____ 3 - 74LS32 @ U38,78,101
 _____ 1 - 74LS51 @ U79
 _____ 3 - 74LS74 @ U53,67,69
 _____ 2 - 74LS86 @ U42,69
 _____ 1 - 74LS132 @ U2
 _____ 4 - 74LS138 @ U17,18,59,
 U72
 _____ 1 - 74LS139 @ U90
 _____ 1 - 74LS151 @ U68
 _____ 4 - 74LS153 @ U50,51,52,
 U84
 _____ 1 - 74LS157 @ U91
 _____ 5 - 74LS161 @ U36,62...65

TTL 74LSxxx ICs (cont)

_____ 2 - 74LS166 @ U4,23
 _____ 3 - 74LS174 @ U1,39,82
 _____ 1 - 74LS175 @ U104
 _____ 3 - 74LS194 @ U55,56,57,
 _____ 1 - 74LS195 @ U83
 _____ 2 - 74LS244 @ U31,32
 _____ 1 - 74LS245 @ U8
 _____ 1 - 74LS251 @ U85
 _____ 6 - 74LS257 @ U10,19,37,
 U54,58,76
 _____ 2 - 74LS259 @ U13,86
 _____ 1 - 74LS266 @ U100
 _____ 1 - 74LS283 @ U61
 _____ 1 - 74LS323 @ U6
 _____ 3 - 74LS367 @ U14,15,16
 _____ 2 - 74LS374 @ U9,29

TTL 74Sxxx ICs

_____ 1 - 74S74 @ U81
 _____ 1 - 74S175 @ U99

LINEAR ICs

_____ 2 - LM555 @ U94,95
 _____ 1 - LM741 @ U93
 _____ 1 - NE556 @ U22
 _____ 1 - NE558 @ U70

TTL BUFFER IC

_____ 1 - 8304 @ U33

MEMORY ICs

Refer to Table 9-1

CPU ICs

_____ 1 - 6502 @ U24
 _____ 1 - 6845 @ U21

DYNAMIC RAM ICs

_____ 8 - 4164 @ U27,28,
 U44...49

STATIC RAM IC

_____ 1 - 6116 @ U3

EPROM ICs

_____ 1 - 2732
 or 2716 @ U35
 _____ 1 - 2764
 or 2732
 or 2716 @ U34
 _____ 5 - 2716 @ U5,7,11,
 U20,30

ACCESSORIES

_____ 1 - "Surf-Board" motherboard
 _____ 1 - RCA video jack (PCB mount)
 _____ 2 - audio jacks (PCB mount)

_____ 2 - 2x10 male header strip (straight)
 _____ 1 - 1x16 male header strip (straight)
 _____ 1 - ABS keyboard case

DISK CONTROLLER CARD: Allows one to interface one or two disk drives with the (TWO DRIVES) microcomputer. With power off, install in slot number 6. Requires firmware (two PROMS).

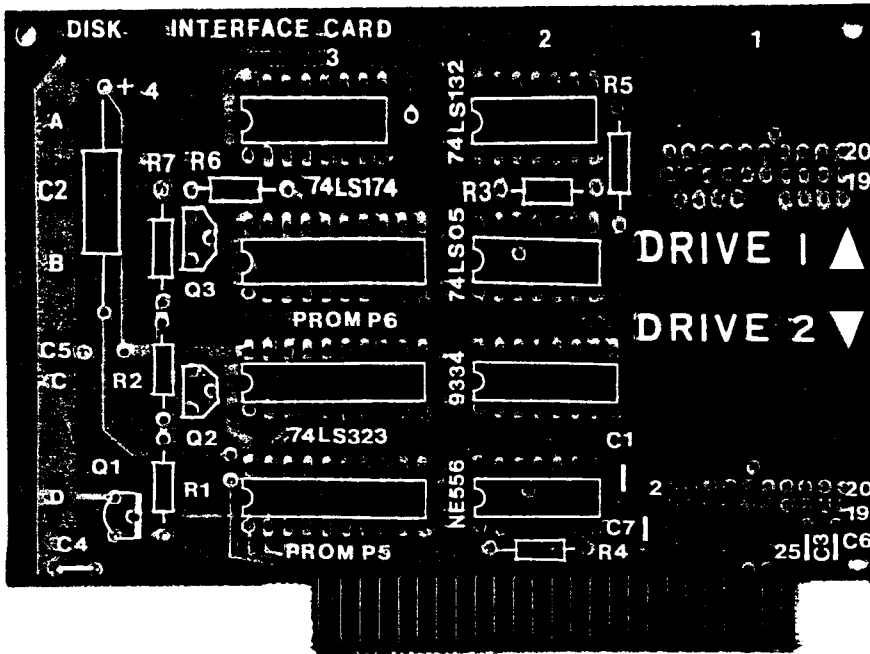

↑ ↑ ↑ ↑ ↑ ↑ ↑ ↑ ↑ ↑ ↑ ↑

*Position header pins of DRIVE 1 and DRIVE 2 UP.

↑ ↑ ↑ ↑ ↑ ↑ ↑ ↑ ↑ ↑ ↑ ↑



SEQUENCE *INDICATES A PRECAUTION

- RESISTORS R** ¼ watt, 5%
- 1 - 68 Ω @ R2
 - 1 - 150 Ω @ R1
 - 1 - 560 Ω @ R6
 - 2 - 3 KΩ @ R3,7
 - 1 - 47 KΩ @ R5
 - 1 - 1 MΩ @ R4

- CAPACITORS C**
- 6 - 0.1 μF @ C1,3,4,5,6,7
 - 1 - 22 μF/25v axial* @ C2
- *Match + of capacitor to + on the layout

- SOCKETS** *Match pin 1 of sockets with pin 1 on the layout. Check that ALL pins of sockets have passed thru ALL holes

- 3 - 14-pin
 - 2 - 16-pin
 - 3 - 20-pin
- 
- pin 1

- TRANSISTORS Q** *Install 3 leads as shown
- 1 - 2N3906 @ Q1
 - 2 - MPSU51 @ Q2,3
- 
- 
- Q1 Q2,3

*Check with supplier re EBC leads of transistors

- CONNECTORS** *Connector pins must be positioned UP as shown by ↑ ↑ ↑ ↑ ↑ ↑
- 2 - 2X10 male header strip, right angles

- INTEGRATED CIRCUITS** *Match pin 1 of IC with pin 1 on layout
- 1 - 74LS05
 - 1 - 74LS174
 - 1 - 74LS132
 - 1 - 74LS323
 - 1 - 9334 (74LS259)
 - 1 - NE556
 - 2 - 6309 PROMs @ P5,6
- 
- pin 1 lower left for ALL sockets & ICs



GUIDE 1-2

APL-DISK CONTROLLER CARD: Allows user to interface one or two disk drives with the computer. With power off, install in slot number 6. Requires firmware (two EPROMs). Switch-selectable for DOS 3.2 or 3.3.

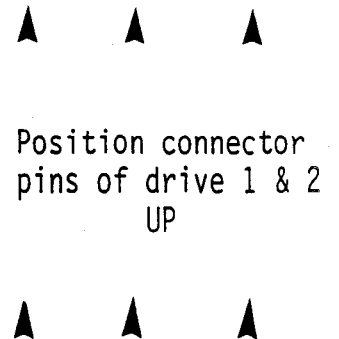
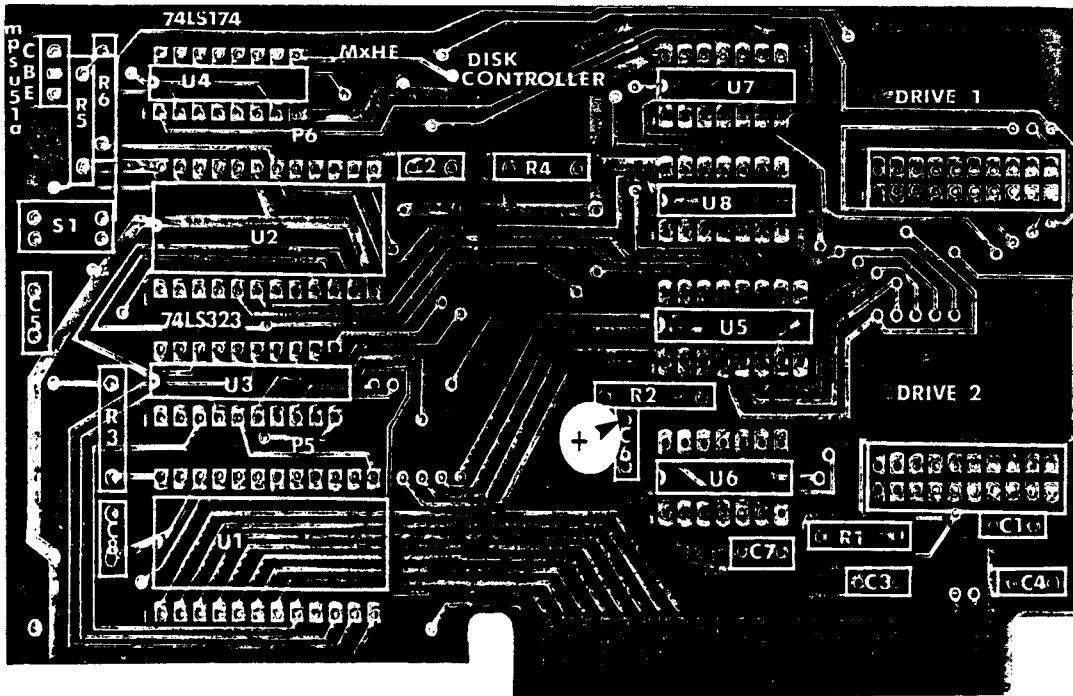

SUGGESTED SEQUENCE *INDICATES A PRECAUTION

- RESISTORS R 1/4 watt, 5%
- ___ 1 - 560 Ω @ R6
 - ___ 3 - 3 KΩ @ R3,4,5
 - ___ 1 - 47 KΩ @ R2
 - ___ 1 - 1 MΩ @ R1

- SWITCH
- ___ 1 - SPST PCB mount @ S1

- CONNECTORS *Position connector pins UP as shown on the layout
- ___ 2 - 2x10 male header strip, right angle

- SOCKETS *Match pin 1 of sockets with pin 1 on the layout
- ___ 3 - 14-pin
 - ___ 2 - 16-pin
 - ___ 1 - 20-pin
 - ___ 2 - 24-pin

- INTEGRATED CIRCUITS *Match pin 1 of ICs with pin 1 on the layout
- ___ 1 - 2716 EPROM 350 ns @ U1 (P5)
 - ___ 1 - 2716 EPROM 350 ns @ U2 (P6)
 - ___ 1 - 74LS323 @ U3
 - ___ 1 - 74LS174 @ U4
 - ___ 1 - 74LS259 @ U5
 - ___ 1 - 556 @ U6
 - ___ 1 - 74LS132 @ U7
 - ___ 1 - 74LS05 @ U8

- CAPACITORS C
- ___ 7 - 0.1 μF Monolithic @ C1,2,3,4,5, C7,8
 - ___ 1 - 22 μF/25V radial* @ C6
- *Match + of capacitor with + on the layout

- TRANSISTOR Q *Position EBC leads as shown on the layout
- ___ 1 - MPSU51A

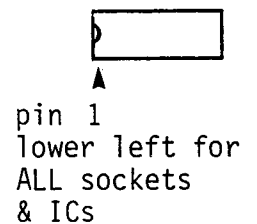

GUIDE 1-3

QUAD DRIVE CARD: Controls from one to four minifloppy disk drives. Automatically boots DOS 3.2 or 3.3, 13 or 16-sector. Requires software (one disk) and firmware (one PROM and one EPROM). With power off, install in slot 6.

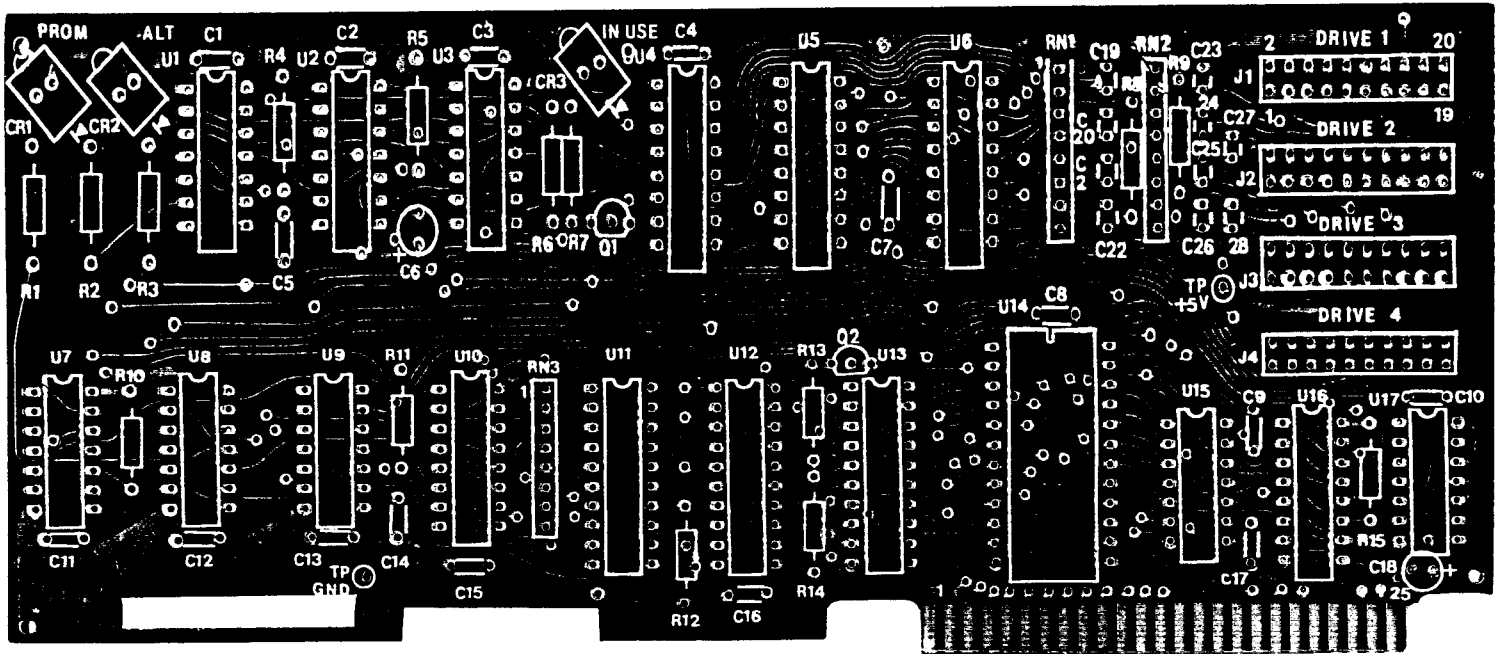

SEQUENCE *INDICATES A PRECAUTION

- RESISTORS** R ¼ watt, 5%
- 2 - 33 Ω @ R8,9
 - 1 - 100 Ω @ R11
 - 1 - 470 Ω @ R12
 - 6 - 680 Ω @ R1,2,6,7,13,14
 - 1 - 4.7 KΩ @ R15
 - 1 - 47 KΩ @ R5
 - 1 - 1 MΩ @ R4
 - 2 - 4S33 Ω SIP* (isolated) @ RN1,2
 - 1 - 4.7 KΩ SIP* (bussed) @ RN3
- *Match pin 1 (common) of SIP with pin 1 on the layout

- SOCKETS** *Match pin 1 of sockets with pin 1 on the layout
- 8 - 14-pin
 - 5 - 16-pin (upper left for ALL SOCKETS)
 - 3 - 20-pin
 - 1 - 24-pin

- CAPACITORS** C
- 1 - 180 pF @ C14
 - 10 - 0.001 μF Monolithic @ C19,20,21, C22,23,24,25,26,27,28
 - 15 - 0.1 μF Monolithic @ C1,2,3,4, C5,7,8,9,10,11,12,13, C15,16,17
 - 1 - 4.7 μF/50v Radial* @ C18
 - 1 - 22 μF/16v Radial* @ C6
- *Match + of capacitor with + on the layout

- TRANSISTORS** Q *Install the three EBC leads as shown
- 2 - 2N3906 @ Q1,2



- DIODES** D
- 3 - LED *Position longer lead (anode) of LEDs as shown @ CR1,2,3



- CONNECTORS**
- 4 - 2x10 male header strip, straight

- INTEGRATED CIRCUITS** *Match pin 1 of ICs with pin 1 on layout

- 1 - 74LS00 @ U9
- 1 - 74LS02 @ U17
- 1 - 74LS05 @ U3
- 1 - 74LS08 @ U8
- 1 - 74LS30 @ U15
- 2 - 74LS74 @ U1,7
- 1 - 74LS138 @ U4
- 1 - 74LS174 @ U10
- 1 - 74LS257 @ U16
- 1 - 74LS259 @ U6
- 1 - 74LS323 @ U12
- 1 - 74LS367 @ U5
- 1 - NE556 @ U2
- 1 - DP8304 @ U13
- 1 - 2716 EPROM @ U14
- 1 - 7649A-5 PROM @ U11



GUIDE 1-4

SHUGART DISK DRIVE INTERFACE ADAPTER CARD; Install in SA400L disk drive to interface drive with disk controller card of computer. Schematics available from supplier.

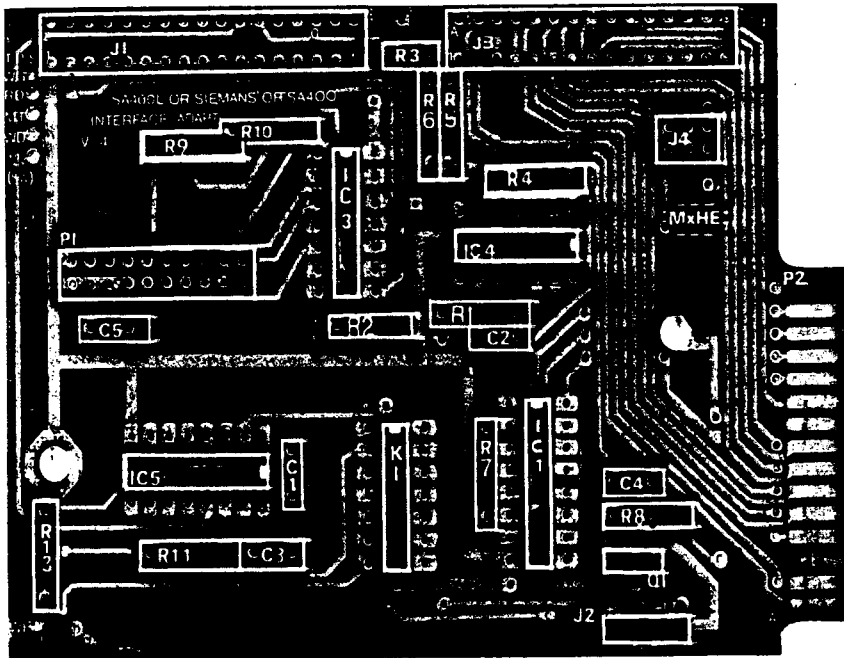

SEQUENCE * INDICATES A PRECISION

RESISTORS R 1/4 watt, 5%

*R3 & R12 are not equipped

- _____ 1 - 330 Ω @ R8
- _____ 1 - 560 Ω @ R7
- _____ 1 - 1.5 KΩ @ R11
- _____ 6 - 3 KΩ @ R1,2,4,5,6,13

*Mount R9 & R10 on the SOLDER SIDE

- _____ 2 - 3 KΩ @ R9,10

SOCKETS * Match pin 1 of sockets with pin 1 on the layout. Check that ALL pins have passed thru ALL holes

- _____ 2 - 14-pin pin 1 ↓
- _____ 2 - 16-pin ↓

CAPACITORS C

- _____ 2 - 330 pF @ C2,3
- _____ 3 - 0.1 F Monolithic @ C1,4,5

TRANSISTOR Q *Match EBC transistor leads with EBC on the layout

- _____ 1 - MPSU51 @ Q1

CONNECTORS *J4 is not equipped

- _____ 1 - 1x4 header, male, straight @ J2

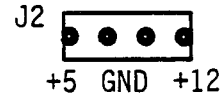

- _____ 1 - 2x10 header, right angle PC mount @ P1 *Position pins UP

*Mount the following connectors on the SOLDER SIDE

- _____ 1 - 34-pin card edge connector @ J1
- _____ 1 - 30-pin card edge connector @ J3

INTEGRATED CIRCUITS *Match pin 1 of ICs with pin 1 on the layout

- _____ 1 - ULN2003 (Sprague) @ IC1
- _____ 1 - 74LS125 @ IC3
- _____ 1 - 74LS86 @ IC4
- _____ 1 - 74LS123 @ IC5



GUIDE 1-5

DISK-WRITER INTERFACE CARD: Allows user to run one or two 5¼" floppy disk drives. Automatically boots 13 or 16-sector diskettes. With power off, install in slot number 6. Requires firmware (one PROM and one EPROM).

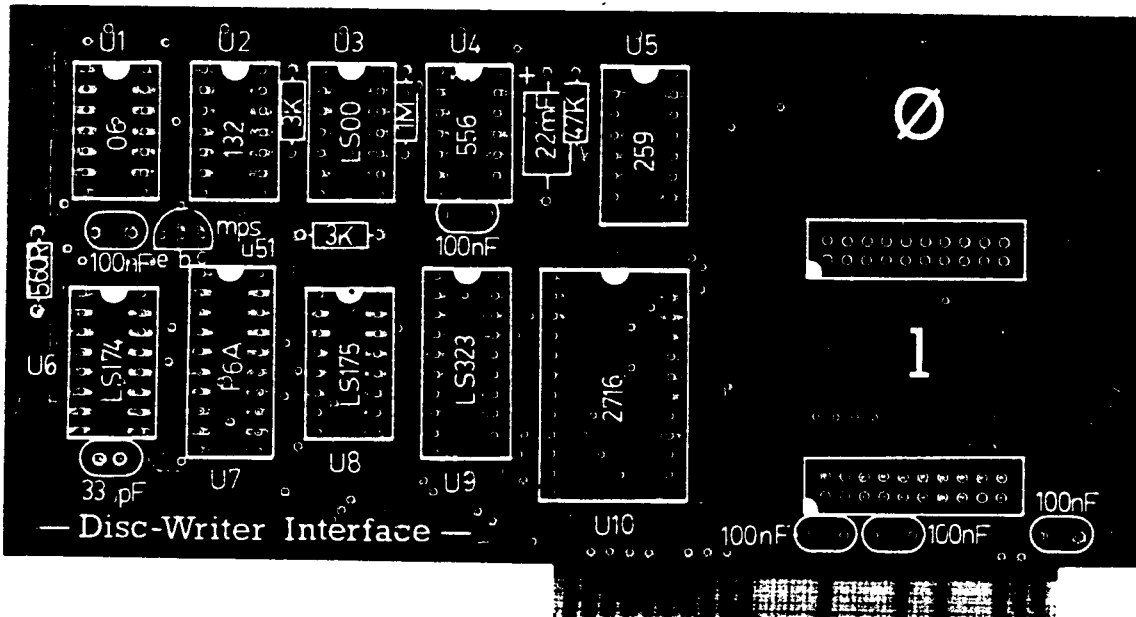

SEQUENCE *INDICATES A PRECAUTION

RESISTORS R ¼ watt, 5%

- _____ 1 - 560 Ω
- _____ 2 - 3 KΩ
- _____ 1 - 47 KΩ
- _____ 1 - 1 MΩ

SOCKETS *Match pin 1 of sockets with pin 1 on the layout. Check that ALL pins have passed thru ALL holes

- _____ 4 - 14-pin
- _____ 3 - 16-pin
- _____ 2 - 20-pin
- _____ 1 - 24-pin

CAPACITORS C

- _____ 1 - 33 pF
 - _____ 5 - 0.1 μF Monolithic @ 100 nF
 - _____ 1 - 22 μF/16V Axial* @ 22 mF
- *Match + of Axial
with + on the layout

TRANSISTOR Q *Position the EBC leads as shown on the layout

- _____ 1 - 2N3904 @ MPSU51

CONNECTORS

- _____ 2 - 2x10 male header, right angles*
- *Position header pins UP

INTEGRATED CIRCUITS *Match pin 1 of ICs with pin 1 on the layout

- _____ 1 - 7406 @ U1
- _____ 1 - 74132 @ U2
- _____ 1 - 74259 @ U5
- _____ 1 - 74LS00 @ U3
- _____ 1 - 74LS174 @ U6
- _____ 1 - 74LS175 @ U8
- _____ 1 - 74LS323 @ U9
- _____ 1 - NE556 @ U4
- _____ 1 - 2716 EPROM @ U10
- _____ 1 - 68F5 (P6A) PROM @ U7



8-INCH FLOPPY DISK CONTROLLER CARD: Increases memory storage capacity by allowing user to interface up to four standard 8" single or double-sided, double-density floppy disk drives with the computer. Allows access to standard 8" CP/M disk with appropriate CP/M card installed & software. Documentation & schematics are available from the supplier. Requires firmware (one EPROM) & software (one disk).

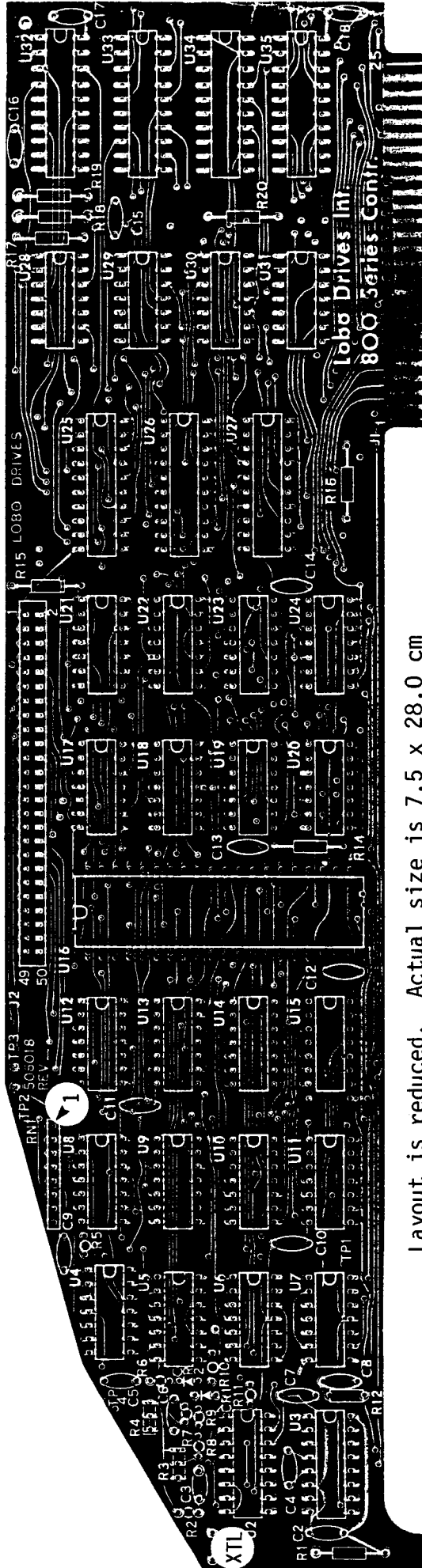

Layout is reduced. Actual size is 7.5 x 28.0 cm

SUGGESTED SEQUENCE *INDICATES A PRECAUTION *INSTALL COMPONENTS LABELLED † ON THEIR ENDS

DIODES D *Position banded end of diode towards the arrow

2 - 1N4148 @ CR1†, CR2†

RESISTORS R ¼ watt, 5% *R13 is not equipped

- 2 - 200 Ω @ R6†, R10†
- 1 - 330 Ω @ R14
- 4 - 1 KΩ @ R5†, R11†, R18, R19
- 1 - 2.2 KΩ @ R16
- 1 - 2.7 KΩ @ R7†
- 4 - 4.7 KΩ @ R1, R12†, R15, R20
- 1 - 5.6 KΩ @ R2†
- 1 - 10 KΩ @ R17
- 1 - 15 KΩ @ R9†
- 1 - 100 KΩ @ R8†
- 1 - 150 Ω 8-pin SIP* bussed @ RN1

*Match pin 1 of SIP with pin 1 on the layout

- 2 - 5 KΩ Trimpot @ R3, 4
- 10-turn recommended

SOCKETS *Match pin 1 of sockets with pin 1 on the layout. Check that ALL pins have passed thru ALL holes

- 23 - 14-pin
- 3 - 16-pin
- 7 - 20-pin
- 1 - 40-pin

CAPACITORS C *C1 is not equipped

- 1 - 68 pF @ C3
- 1 - 100 pF @ C13
- 2 - 150 pF @ C7, 8
- 1 - 200 pF Silver Mica @ C4**
- 1 - 0.001 μF @ C5
- 1 - 0.01 μF @ C6
- 10 - 0.1 μF Monolithic @ C2, 9, 10, 11, C12, 14, 15, 16, 17, 18

CRYSTAL Y *Fold crystal flat against the card before soldering

- 1 - 8.0000 MHz @ XTL

CONNECTOR

- 1 - 2x25 header, male, straight @ J2

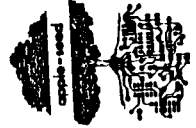

(continued)

5 1/4-INCH FLOPPY DISK CONTROLLER CARD (continued)

INTEGRATED CIRCUITS *Match pin 1 of ICs

with pin 1 on the layout

U1 is not equipped

- 1 - 74LS00 @ U11
- 1 - 74LS02 @ U9
- 2 - 74LS04 @ U4,10
- 2 - 74LS07 @ U12,20
- 1 - 74LS08 @ U18
- 2 - 74LS14 @ U8,24
- 5 - 74LS32 @ U14,17,19,22,23
- 4 - 74LS74 @ U5,6,7,21
- 1 - 74LS123 @ U2
- 1 - 74LS175 @ U15
- 4 - 74LS177 or 74LS197 @ U28,29,30,31
- 2 - 74LS240 @ U33,34
- 2 - 74LS244 @ U26,27
- 1 - 74LS273 @ U32
- 1 - 74LS373 @ U35

- 1 - 7438 @ U13
- 1 - 74124 @ U3 Substitutes:
74LS124 - use 130 pF @ C4**
74S124 - use 330 pF @ C4**

- 1 - MB8866 or MB8876 (Fujitsu)
or WD1791 (Western Digital) @ U16

- 1 - 28S42 (T.I.) 512x8 PROM @ U25

16 K RAM CARD: Expands the capabilities of your system by increasing its internal memory to 64 K of RAM memory. With power off, install in slot 0.

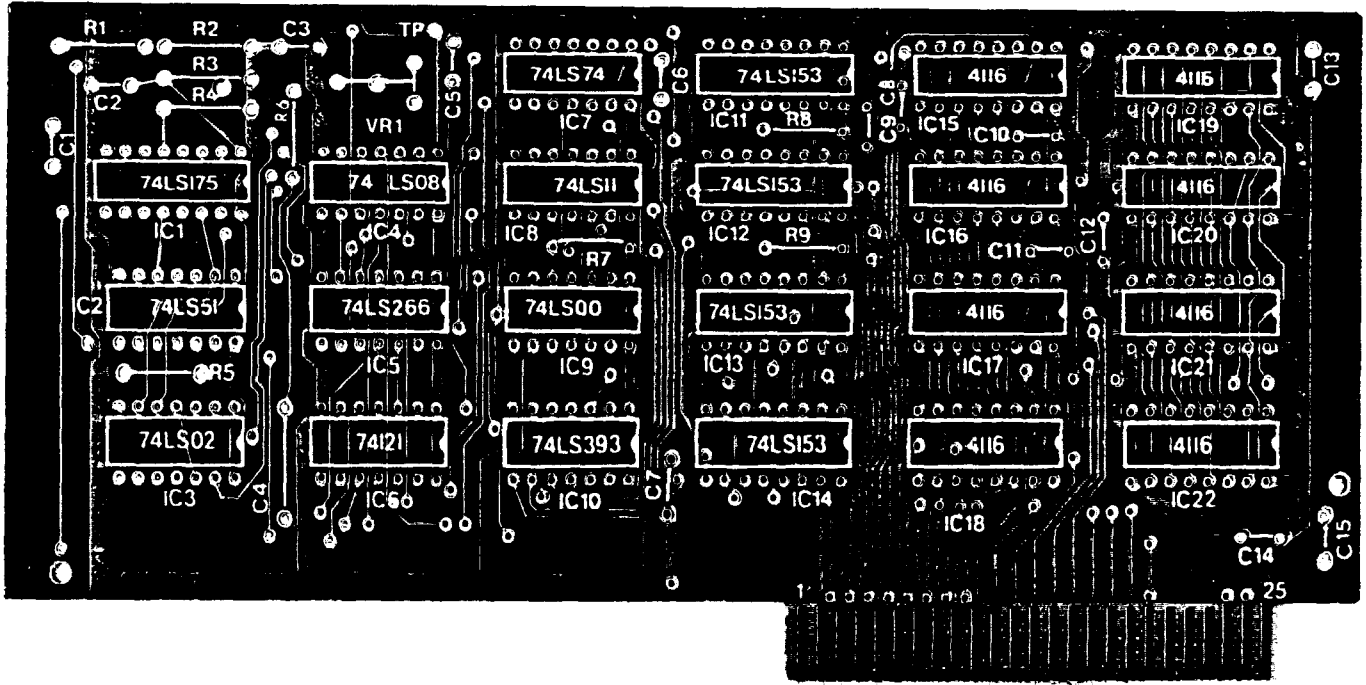

SEQUENCE

***INDICATES A PRECAUTION**

- RESISTORS R** 1/4 watt, 5%
- 4 - 2.7 KΩ @ R1,2,3,5
 - 5 - 1 KΩ @ R4,6,7,8,9
 - 1 - 2.2 KΩ @ VR1*

*Position this resistor as shown by arrows

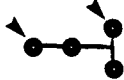

CAPACITORS C

- 1 - 68 pF @ C1
 - 9 - 0.1 μF @ C3,5,6,8,9,10,11,12,13
 - 1 - 100 pF @ C4
 - 4 - 15 μF/16v Tantalum* @ C2,7,14,15
- *Match + of capacitors as shown

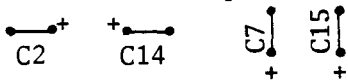

SOCKETS *Match pin 1 of sockets with pin 1 on the layout. Check that ALL pins have passed thru ALL holes

- 9 - 14-pin
- 13 - 16-pin

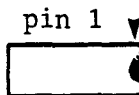

INTEGRATED CIRCUITS *Match pin 1 of IC with pin 1 on layout

- 1 - 74LS00 @ IC9
- 1 - 74LS02 @ IC3
- 1 - 74LS08 @ IC4
- 1 - 74LS11 @ IC8
- 1 - 74LS51 @ IC2
- 1 - 74LS74 (Hitachi) @ IC7
- 1 - 74LS175 @ IC1
- 1 - 74LS266 @ IC5
- 1 - 74LS393 @ IC10
- 1 - 74LS121 @ IC6
- 4 - 74LS153 @ IC11,12,13,14
- 8 - 4116 RAM (TI) @ IC15,16,17,18,19, IC20,21,22

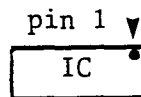

GUIDE 2-2

16 K RAM CARD: Adds an additional 16K of dynamic RAM to the 48K RAM on board. Can be used to hold a second language or as transient space for CP/M. With power off, install in slot number 0.

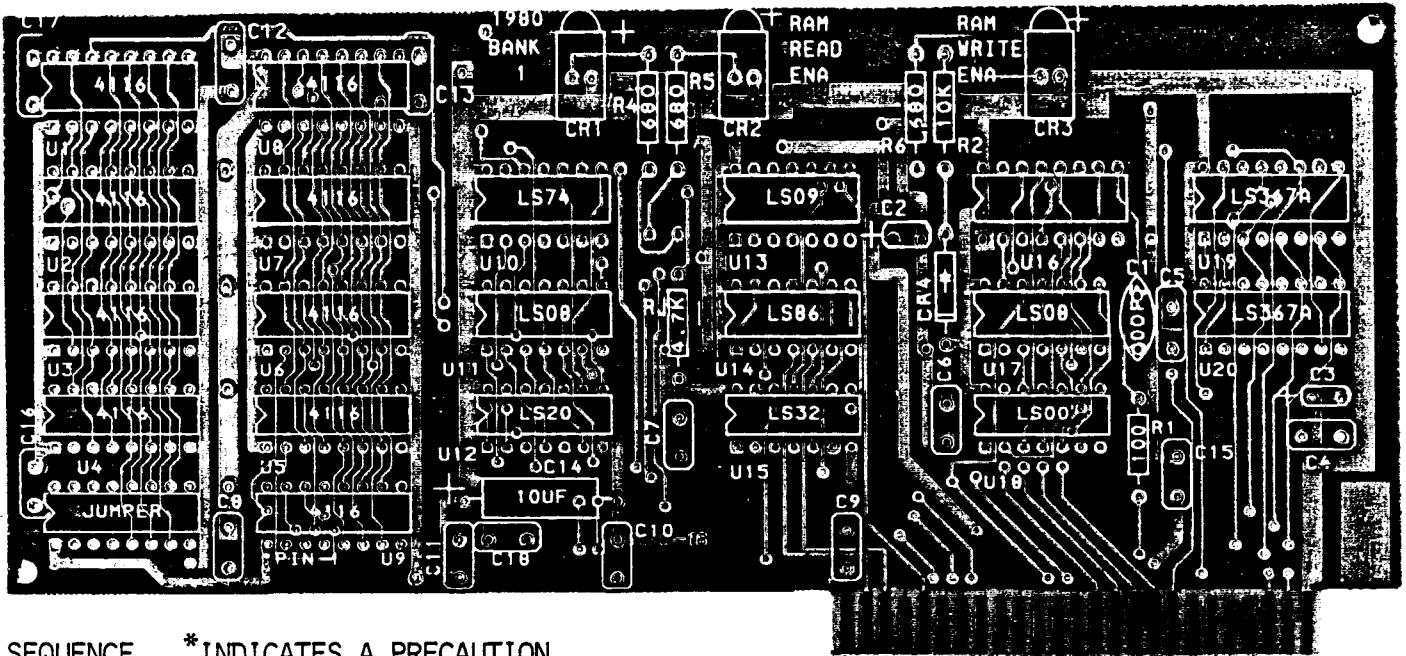

SEQUENCE *INDICATES A PRECAUTION

DIODES D *Position banded end of diode (cathode) as shown

- 1 - 1N914

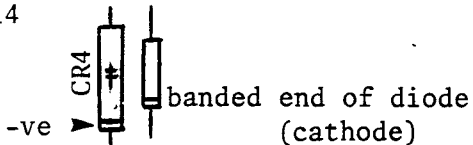

- 3 - LED *Position longer lead (+ve) of diode as shown on the layout. Install LEDs last

RESISTORS R 1/4 watt, 5%

- 1 - 100 Ω @ R1
- 3 - 680 Ω @ R4,5,6
- 1 - 10 KΩ @ R2
- 1 - 4.7 KΩ @ R3 *labelled "RJ" on the layout

CAPACITORS C

- 1 - 220 pF @ C1
 - 14 - 0.1 μF Monolithic @ C4 to 13 & C15 to 18
 - 2 - 10 μF/25v Tantalum* @ C2,3
 - 1 - 10 μF/25v axial* @ C14
- *Match + of capacitor with + on layout

SOCKETS *Match pin 1 of sockets with pin 1 on layout. Check that ALL pins have passed thru ALL holes

- 8 - 14-pin
 - 13 - 16-pin
-
- pin 1

INTEGRATED CIRCUITS *Match pin 1 of IC with pin 1 on layout

- 1 - 74LS00 @ U18
- 2 - 74LS08 @ U11,17
- 1 - 74LS09 @ U13
- 1 - 74LS20 @ U12
- 1 - 74LS32 @ U15
- 1 - 74LS74 @ U10
- 1 - 74LS86 @ U14
- 1 - 74LS175 @ U16
- 2 - 74LS367A @ U19,20
- 9 - 4116 RAM @ U1 to 9

RIBBON CABLE (10-15 cm long)

- 2 - 16-pin DIP headers

*With POWER OFF connect as follows: Remove one 4116 RAM IC from location E3 of motherboard (extreme upper left corner). Connect ribbon cable from location J1 (jumper) of language card to E3 of motherboard. MATCH pin 1 of card to pin 1 of motherboard.



NuScope Associates

LANGUAGE CARD: Adds an additional 16 K of dynamic RAM memory to the 48 K on board. Can be used to hold a second language or as transient space for CP/M. With power off, install in slot number 0. Requires F8 ROM from motherboard on the card.

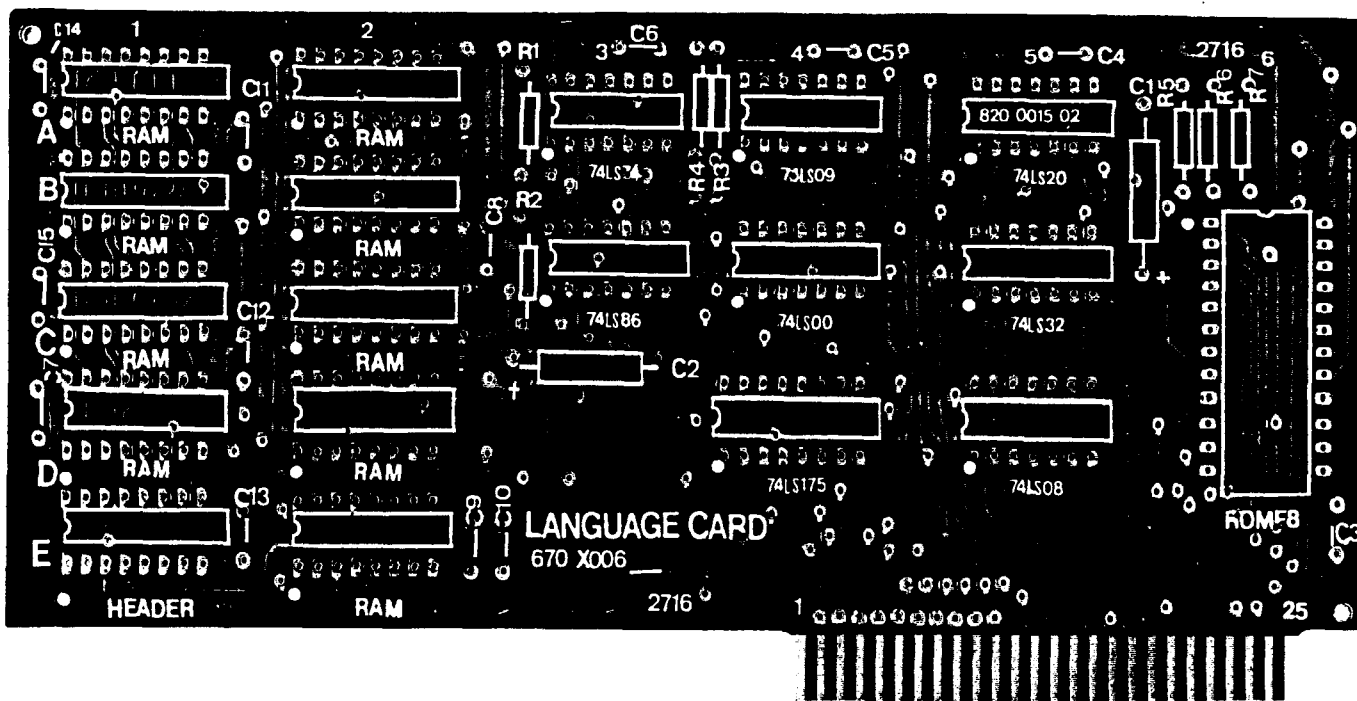

SEQUENCE *INDICATES A PRECAUTION

RESISTORS R 1/4 watt, 5%
 _____ 5 - 3 K @ R1,2,3,5,6
 _____ 2 - 1 K @ R4,7

CAPACITORS C
 _____ 2 - 10 µF/25v axial* @ C1,2
 _____ 1 - 10 µF/25v Tantalum* @ C3
 _____ 12 - 0.1 µF @ C4 to C15
 *Match + of capacitor to + on the layout

SOCKETS *Match pin 1 of sockets with pin 1 (white dot) on the layout. Check that ALL pins have passed thru ALL holes

_____ 7 - 14-pin
 _____ 11 - 16-pin
 _____ 1 - 24-pin

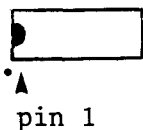

INTEGRATED CIRCUITS *Match pin 1 of ICs with pin 1 (white dot)

_____ 1 - 74LS00
 _____ 1 - 74LS08
 _____ 1 - 74LS09
 _____ 1 - 74LS20
 _____ 1 - 74LS32
 _____ 1 - 74LS74
 _____ 1 - 74LS86
 _____ 1 - 74LS175
 _____ 9 - 4116 RAM
 _____ 1 - F8 ROM from motherboard installed on the card @ ROMF8

RIBBON CABLE (10-15 cm long)
 _____ 1 - 16 pin DIP header

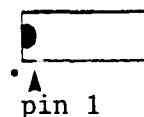

*With POWER OFF connect as follows: Remove one 4116 RAM IC from location E3 of motherboard (extreme upper left corner). Connect ribbon cable from location E1 of language card to E3 of motherboard. MATCH pin 1 of card to pin 1 of motherboard.



K RAMCARD: Allows the user to expand the on-board 48K RAM memory by 64K or 128K bytes. With power off, install in slot number 0. Requires software (three disks).

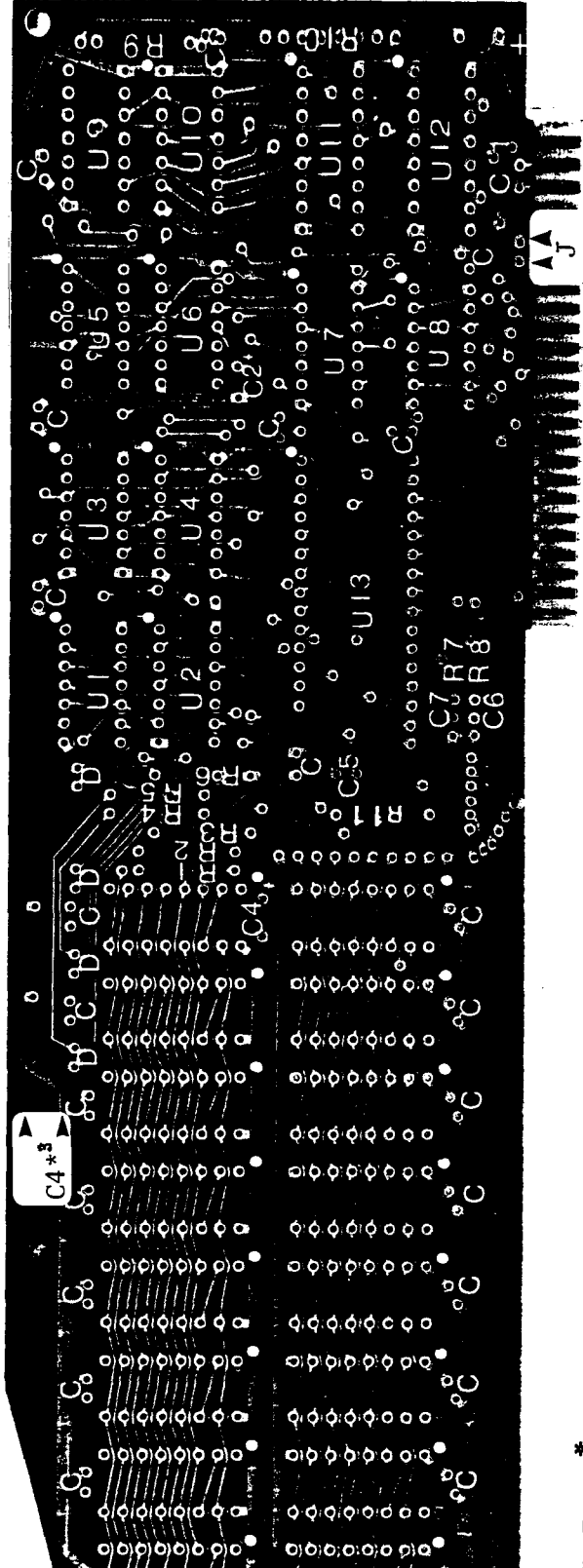

#1 Position
R9 as shown

C4*3 Some cards may have C4 positioned as shown on layout

INCE *INDICATES A PRECAUTION

- TORS R 1/4 watt, 5%
- 6 - 100 Ω @ R1,2,7,8,9*1,11
- 4 - 470 Ω @ R3,4,5,6
- 1 - 2.2 KΩ x 8 SIP @ R10
- *Match pin 1 of SIP with white "dot" on layout
- TS *Match pin 1 of sockets with white "dot" on layout. Check that ALL pins have passed thru ALL holes
- 10 - 14-pin
- 18 - 16-pin
- 1 - 28-pin

Refer to the APPLE-SEED by Raymond Kosmic for complete assembly instructions.



NuScope Associates

CAPACITORS C

- 24 - 0.1 μF Monolithic @ positions C*2
- 4 - 22 pF Monolithic @ C5,6,7,8
- 2 - 2.2 μF/25V Tantalum* @ C2, C4*3
- 1 - 10 μF/25V Axial* @ C1

*Match + of capacitors with + on the layout

MODIFICATION *Strap (if required) the two feed-thru holes directly above pins 19 & 20 @ J as shown on the layout

LIGHT EMITTING DIODE D

- 4 - LEDs at locations labelled D
- *Match + of diode with + on layout

*2 Install a 0.1 μF cap (not shown on board) between U2 and U4

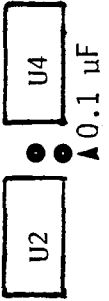

INTEGRATED CIRCUITS *Match pin 1 of ICs with pin 1 (white dot) on the layout

- 1 - 74LS00 @ U9
- 1 - 74LS02 @ U8
- 1 - 74LS08 @ U10
- 2 - 74LS51 @ U1,2
- 1 - 74LS74 @ U6
- 1 - 74LS93 @ U5
- 1 - 74LS107 @ U4
- 2 - 74LS175 @ U11,12
- 1 - 74LS260 @ U3
- 1 - 74LS266 @ U7
- 1 - MC3242AP @ U13
- 16 - TMS4164 RAM (or equivalent)

*For 64 K bytes of additional RAM install eight 4164s along the top row; for 128 K, use both rows

GUIDE 2-5

ROM INTEGER CARD: Allows an extra 16K of ROM to be switched in and out of memory in place of on-board ROM. With power off, install in slot number 0. Requires firmware (EPROMs).

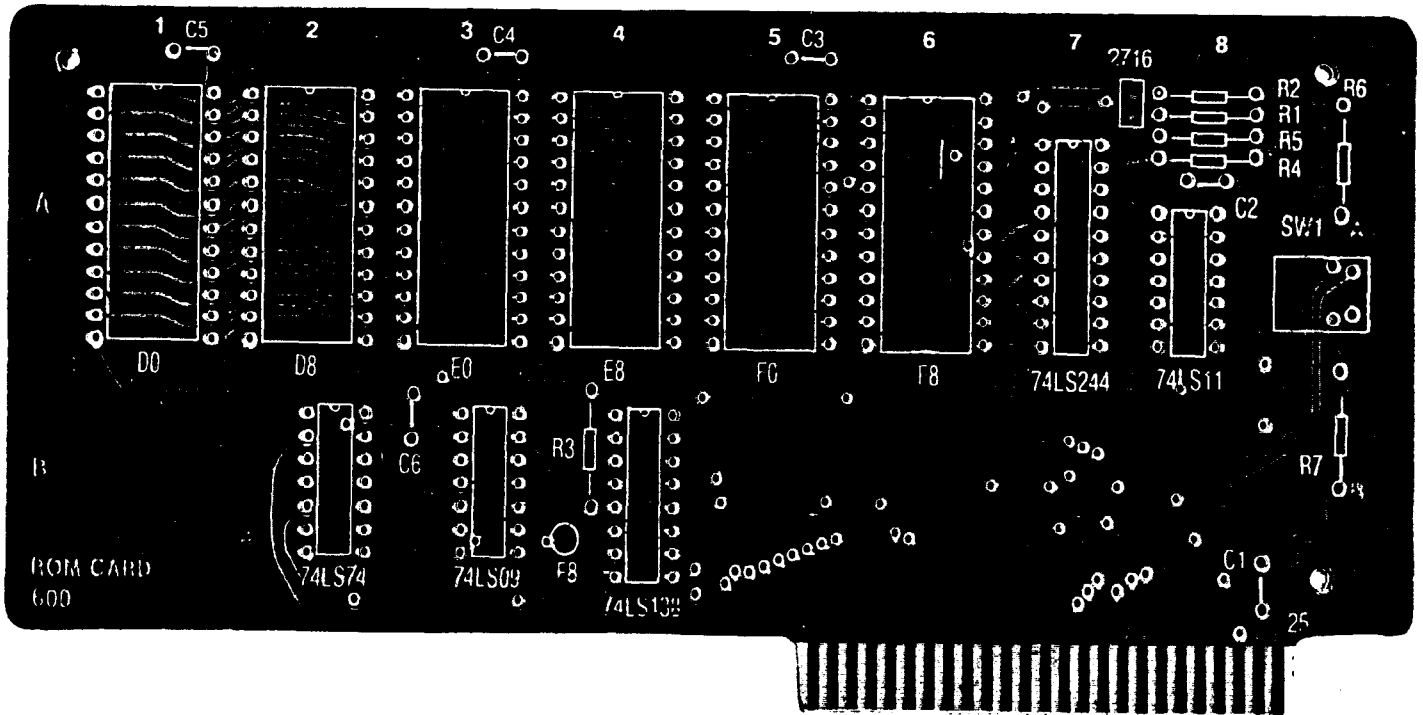

SEQUENCE

*INDICATES A PRECAUTION

RESISTORS R ¼ watt, 5%
 _____ 5 - 2.7 KΩ @ R1,2,3,4,5
 _____ 2 - 10 KΩ @ R6,7

INTEGRATED CIRCUITS *Match pin 1 of IC with pin 1 on layout

*To use five 2716 EPROMs, jumper at a and b as shown (between 7 and 8)

CAPACITORS C
 _____ 6 - 0.1 μF @ C1,2,3,4,5,6

SOCKETS *Match pin 1 of sockets with pin 1 on the layout. Check that ALL pins of sockets have passed thru ALL holes

_____ 3 - 14-pin pin 1 
 _____ 1 - 16-pin
 _____ 1 - 20-pin
 _____ 6 - 24-pin

_____ 1 - 74LS09
 _____ 1 - 74LS11
 _____ 1 - 74LS74
 _____ 1 - 74LS138
 _____ 1 - 74LS244
 _____ 6 - 2716 EPROMs @ D0, D8, E0, E8, F0, F8

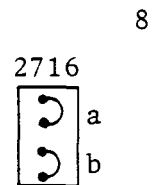

pin 1 upper left for ALL sockets & ICs 

SWITCH
 _____ 1 - single-pole, double-throw @ SW1



GUIDE 2-6

16 K RAM CARD: Enhances the power of the computer by increasing the on-board 48 K of RAM to 64 K. Can be used to hold a second language or as a transient space for CP/M. With power off, install in slot number 0.

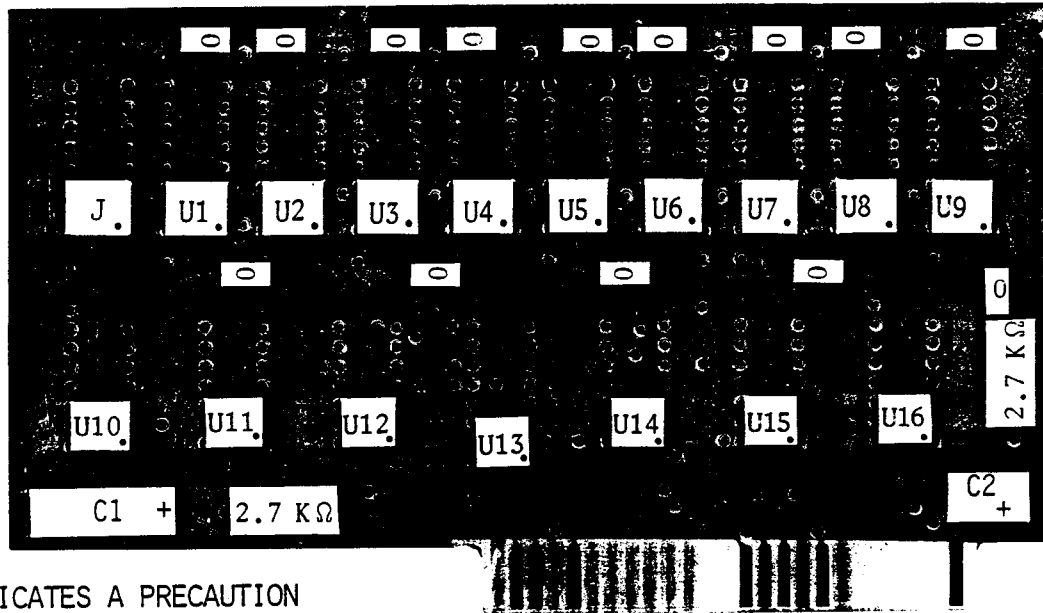

SEQUENCE *INDICATES A PRECAUTION

RESISTORS R ¼ watt, 5%
 _____ 2 - 2.7 KΩ

SOCKETS *Match pin 1 of sockets with pin 1 (dot) on the layout. Check that ALL pins have passed thru ALL holes

_____ 6 - 14-pin
 _____ 11 - 16-pin

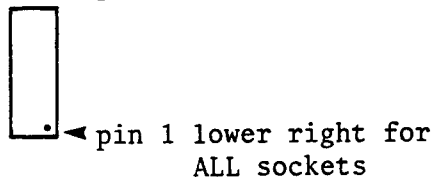

CAPACITORS C
 _____ 14 - 0.1 μF Monolithic @ ○
 _____ 1 - 10 μF/16V Axial* @ C1
 _____ 1 - 10 μF/16V Radial* @ C2
 *Match + of TWO electrolytic capacitors with + on the layout

RIBBON CABLE
 _____ 1 - 10-15 cm length of 16-conductor ribbon cable with one 16-pin DIP header at each end

INTEGRATED CIRCUITS *Match pin 1 of ICs with pin 1 (dot) on the layout

_____ 9 - 4116 RAM @ U1,2,3,4,5,6,7,8,9
 _____ 1 - 74LS74 @ U10
 _____ 1 - 74LS00 @ U11
 _____ 1 - 74LS08 @ U12
 _____ 1 - 74LS175 @ U13
 _____ 1 - 74LS32 @ U14
 _____ 1 - 74LS86 @ U15
 _____ 1 - 74LS30 @ U16

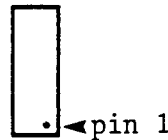

INSTALLATION
 *With POWER OFF, install as follows:
 Remove one 4116 RAM IC from location E3 of motherboard (extreme upper left corner). Connect the ribbon cable from location J (jumper) of the 16 K card to E3 socket of the motherboard. *MATCH pin 1 of J to pin 1 on the motherboard.

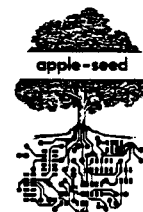

128 K RAM EXPANDER: Allows user to expand the computer's memory to a full 128 K of dynamic RAM. With power off, install in: a) slot 0, if no other memory card is available; b) any available slot, if other memory card is in slot 0. Requires software (three disks) and firmware (one PAL).

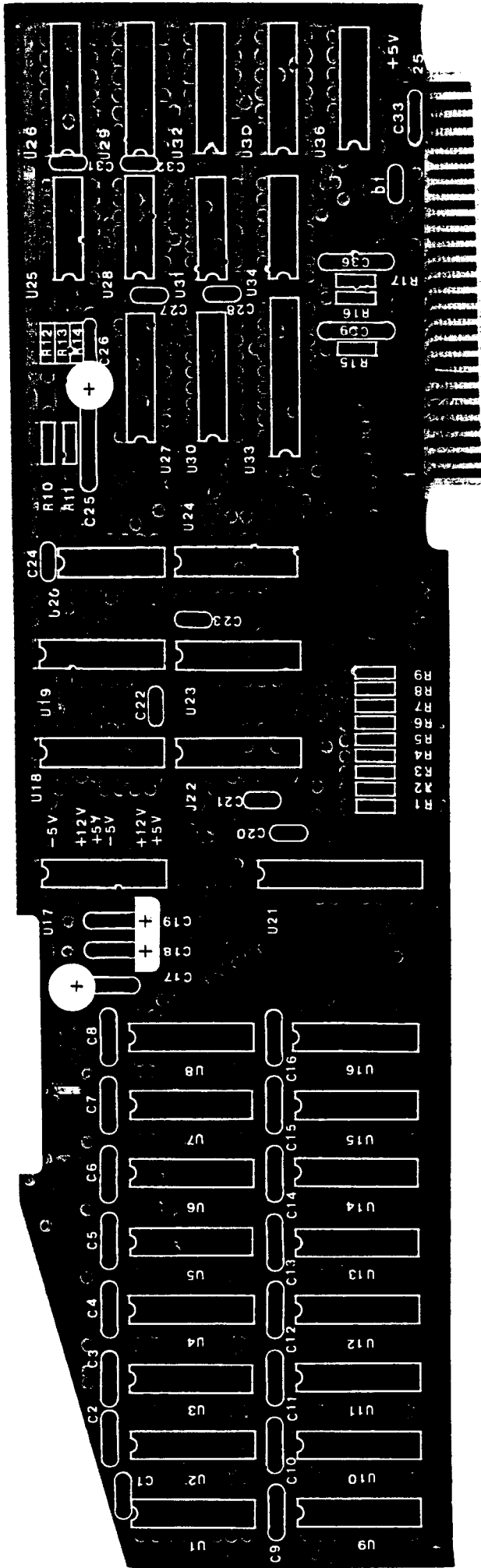

SEQUENCE *INDICATES A PRECAUTION

DIODE D *Position banded end (cathode) of diode towards the SQUARE solder pad

1 - 1N4148 @ D1

RESISTORS R 1/4 watt, 5%

3 - 100 Ω @ R15, 16, 17

12 - 27 Ω @ R1 to 9, R11, 13, 14

2 - 5.6 KΩ @ R10, 12

SOCKETS *Match pin 1 of sockets with pin 1 on layout. Check that ALL pins have passed thru ALL holes

- 10 - 14-pin
- 24 - 16-pin
- 2 - 20-pin

CAPACITORS C

3 - 220 pF @ C26, 36, 39

26 - 0.1 μF Monolithic

@ C1, 2, 3, 4, 5, 6, 7, 8, 9, 10, 11,

C12, 13, 14, 15, 16, 20, 21, 22,

C23, 24, 27, 28, 31, 32, 33

4 - 10 μF/16V Axial* @ C17, 18, 19, 25

*Match + of radials with + on the layout

INTEGRATED CIRCUITS *Match pin 1 of

IC with pin 1 on the layout

2 - 74LS08 @ U25, 36

1 - 74LS244 @ U21

1 - 74LS32 @ U34

1 - 74LS37 @ U28

3 - 74LS74 @ U29, 31, 35

1 - 74LS107 @ U32

2 - 74LS158 @ U22, 23

2 - 74LS175 @ U27, 30

2 - 74LS258 @ U18, 19

1 - 74LS367 @ U24

2 - 74LS393 @ U20, 26

- empty slot @ U17

1 - PAL10L8 (MMI) Programmed

Array Logic

16 - 4164 RAM, 200 ns @ U1 to 16

NuScope Associates



GUIDE 2-8

Z-80/64K 128 K RAM EXPANDER: This card adds 128 K bytes of memory and can only be used with the Z80/64 K card (GUIDE 4-4). With power off, mate female headers J1 & J2 of the EXPANDER card with the male headers P2 & P3 respectively, of the Z80/64 K card. Requires software.

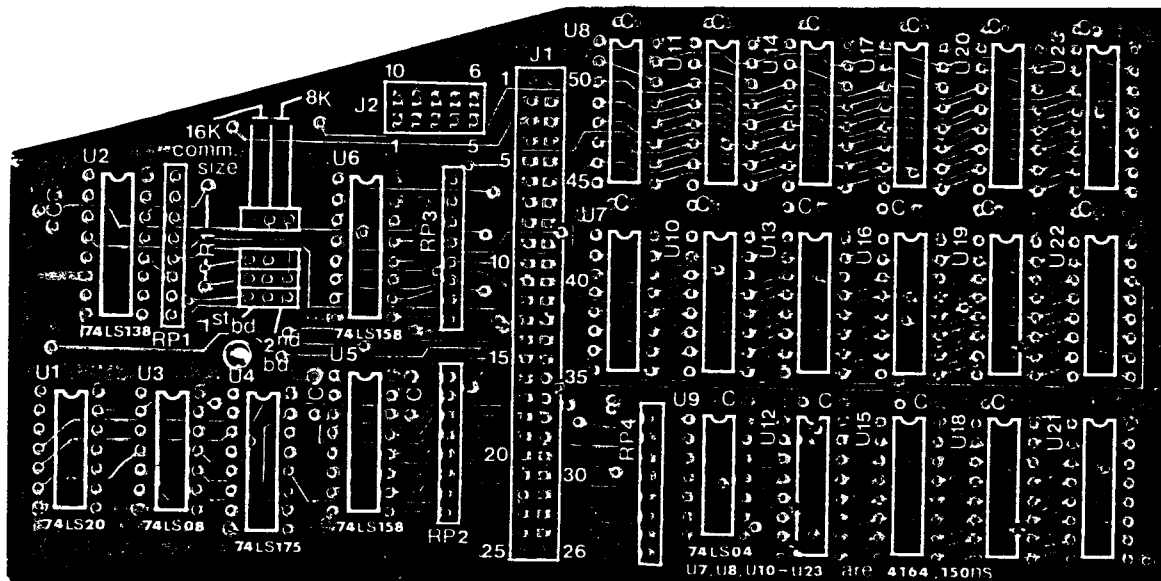

SEQUENCE *INDICATES A PRECAUTION

RESISTORS R ¼ watt, 5%

- 1 - 22 Ω R1
- 4 - 22 Ω (or 33 Ω) SIP*, isolated @ RP1,2,3,4 White dot is pin 1
- *Four discrete resistors may be substituted for each SIP

SOCKETS *Match pin 1 of sockets with pin 1 on the layout. Check that ALL pins have passed thru ALL holes

- 3 - 14-pin
 - 20 - 16-pin
- pin 1 → 

CAPACITORS C

- 19 - 0.1 Monolithic

HEADER STRIPS

- 1 - 1x2 male, straight @ 2
- 3 - 1x3 male, straight @ 1,3,4
- *J1 & *J2 are mounted on the SOLDER SIDE and soldered to the COMPONENT SIDE
- 1 - 2x25 female @ J1*
- 1 - 2x5 female @ J2*

INTEGRATED CIRCUITS *Match pin 1 of ICs with pin 1 on the layout

- 1 - 74LS04
- 1 - 74LS08
- 1 - 74LS20
- 1 - 74LS138
- 2 - 74LS158 or 74LS258
- 1 - 74LS175
- 16 - 4164 RAM 150 ns, 7-bit refresh



GUIDE 2-9

PRELUDE 128 EXTENDER: Increase the 48 K bytes of on-board memory by 128 K bytes. With power off, install in slot 0. Requires software (three diskettes).

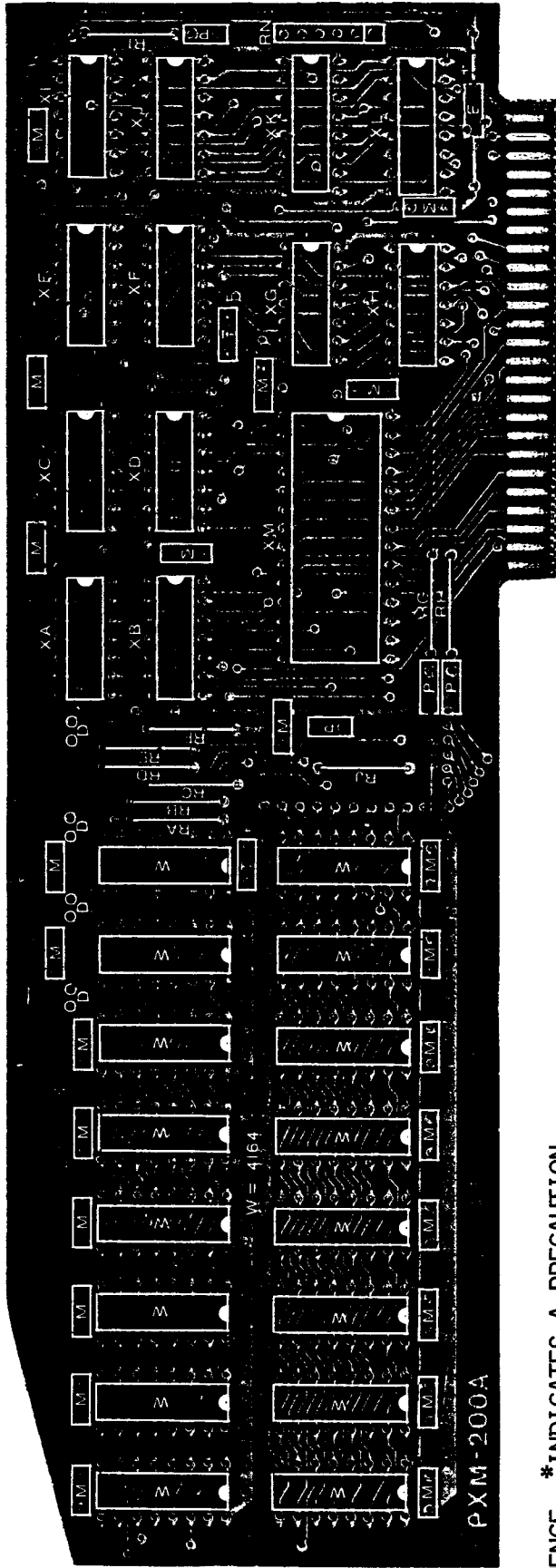

SEQUENCE *INDICATES A PRECAUTION

- RESISTORS R 1/4 watt, 5%
 6 - 100 Ω @ RA,B,G,H,I,J
 4 - 470 Ω @ RC,D,E,F
 1 - 2.2 KΩ 6-pin SIP* @ RN
 *Match pin 1 of SIP with pin 1 (square) on layout

- SOCKETS *Match pin 1 of sockets with pin 1 on the layout. Check that ALL pins have passed thru ALL holes
 10 - 14-pin
 18 - 16-pin
 1 - 28-pin



- CAPACITORS C
 4 - 22 pF @ P
 24 - 0.1 μF Monolithic @ M
 2 - 2.2 μF/25V Tantalum* @ T
 1 - 10 μF/25V Axial* @ B
 *Match + of capacitors with + on the layout

- DIODES D (LED)
 4 - LEDs* @ D Match + of LEDs with + on the layout as shown



- INTEGRATED CIRCUITS *Match pin 1 of ICs with pin 1 on the layout
 1 - 74LS00 @ XI
 1 - 74LS02 @ XH
 1 - 74LS08 @ XJ
 2 - 74LS51 @ XA,B
 1 - 74LS74 @ XF
 1 - 74LS93 @ XE
 1 - 74LS107 @ XD
 2 - 74LS175 @ XK,L
 1 - 74LS260 @ XC
 1 - 74LS266 @ XG
 1 - MC3242AP @ XM
 16 - 4164 RAM @ W

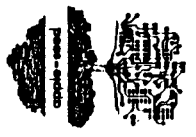

NuScope Associates

GUIDE 2-10

ZIP LOADER: Stores up to 512K RAM of programs in eight EPROMs for instant loading. Accepts standard 27 series (2708 to 27512) EPROMs. With power off, install in any slot except 0. Requires software (one diskette).

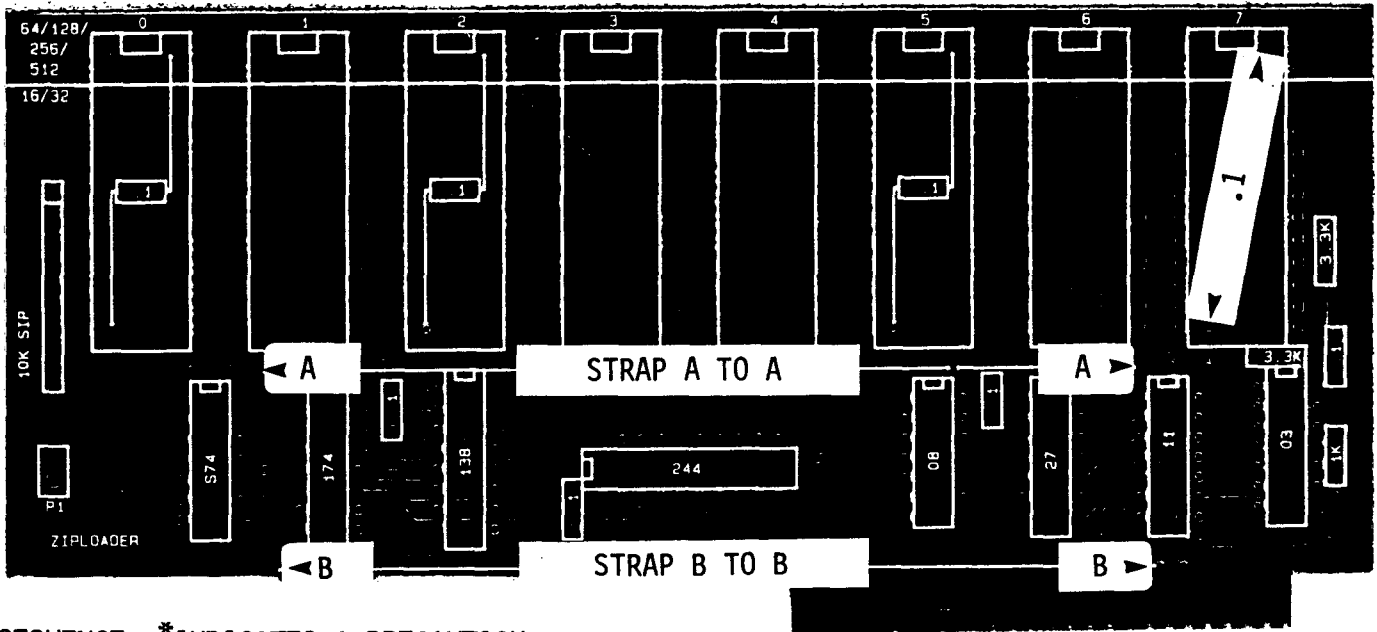

SEQUENCE *INDICATES A PRECAUTION

RESISTORS ¼ watt, 5%

- 1 - 1 KΩ
- 2 - 3.3 KΩ
- 1 - 10 KΩ 10-pin SIP bussed* Match pin 1 of SIP with pin 1 (square) on the layout

SOCKETS *Match pin 1 of sockets with pin 1 on the layout. Check that ALL pins have passed thru ALL holes

- 5 - 14-pin
- 2 - 16-pin
- 1 - 20-pin
- 8 - 28-pin

CAPACITORS C

- 4 - 0.1 μF Monolithic @ .1
- *Install the following capacitors on the SOLDER SIDE.
- 4 - 0.1 μF axial labelled .1 in the middle of each EPROM socket 0,2,5,7 as shown on the layout

SWITCH

- 1 - SP/ST (single pole single throw) @ P1

INTEGRATED CIRCUITS *Match pin 1 of ICs with pin 1 on the layout

- 1 - 74LS03
- 1 - 74LS08
- 1 - 74LS11
- 1 - 74LS27
- 1 - 74LS74
- 1 - 74LS138
- 1 - 74LS174

MODIFICATION: as shown on the layout
Use two jumper wires to strap
A to A
B to B



FAST DISK II: RAM Disk Emulator. Stores data in RAM rather than on disks for fast recall. Each card holds 288 K bytes of memory - the equivalent of two disk drives. With power off, install in any slot. Recommended: Slot 5 for first Fast Disk; Slots 5 and 4 for first and second Fast Disk cards, respectively. Requires software drivers (DOS, CP/M, PASCAL).

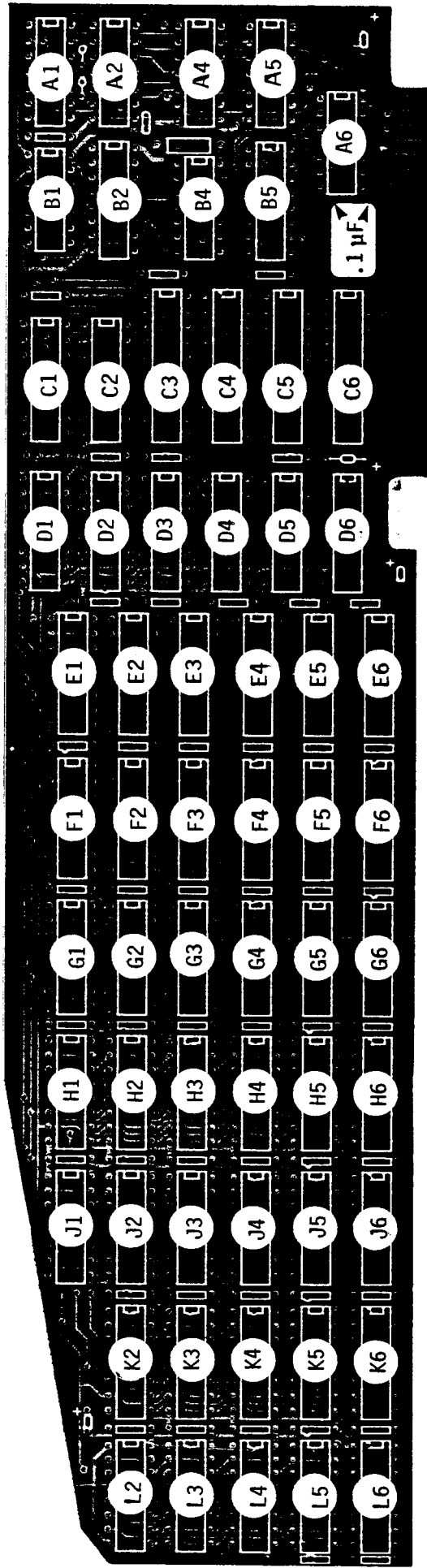

SEQUENCE *INDICATES A PRECAUTION

SOCKETS *Match pin 1 of sockets with pin 1 on the layout. Check that ALL pins have passed thru ALL holes

- 7 - 14-pin
- 50 - 16-pin
- 4 - 20-pin

CAPACITORS C
 1 - 470 pF @ ∞
 49 - 0.1 μ F Monolithic @ ∞
 4 - 10 μ F/16V Tantalum* @ ∞ +
 *Match + of Tantalums with + on the layout

RESISTORS R 5%

- 2 - 33 Ω 1/8 watt @ \bullet
- 1 - 1 K Ω 1/4 watt @ between A4 and B4

INTEGRATED CIRCUITS *Match pin 1 of IC with pin 1 on the layout

- 2 - 74LS00 @ A1, B4
- 2 - 74LS32 @ A4, A6
- 1 - 74LS42 @ B5
- 2 - 74LS74 @ A5, B1
- 1 - 74LS132 @ A2
- 1 - 74LS245 @ C6
- 3 - 74LS374 @ C3, C4, C5
- 1 - CD4040 @ B2

INTEGRATED CIRCUITS (continued)

- 16 - 4116 DRAM 150 ns @ D5,6; E5,6; F5,6; G5,6; H5,6; J5,6; K5,6; L5,6
- 32 - 4164 DRAM 150 ns @ C1,2; D1,2,3,4; E1,2,3,4; F1,2,3,4; G1,2,3,4; H1,2,3,4; J1,2,3,4; K2,3,4; L2,3,4

Memory ICs for second disk drive include: D3,4,6; E3,4,6; F3,4,6; G3,4,6; H3,4,6; J3,4,6; K3,4,6; L3,4,6



GUIDE 2-12

MEGAWORKS I (IIe): Add 80-column text, double Hi Res graphics, and up to 512K memory. With power off, install in auxilliary slot. Requires software (one to three diskettes), modification (one cut).

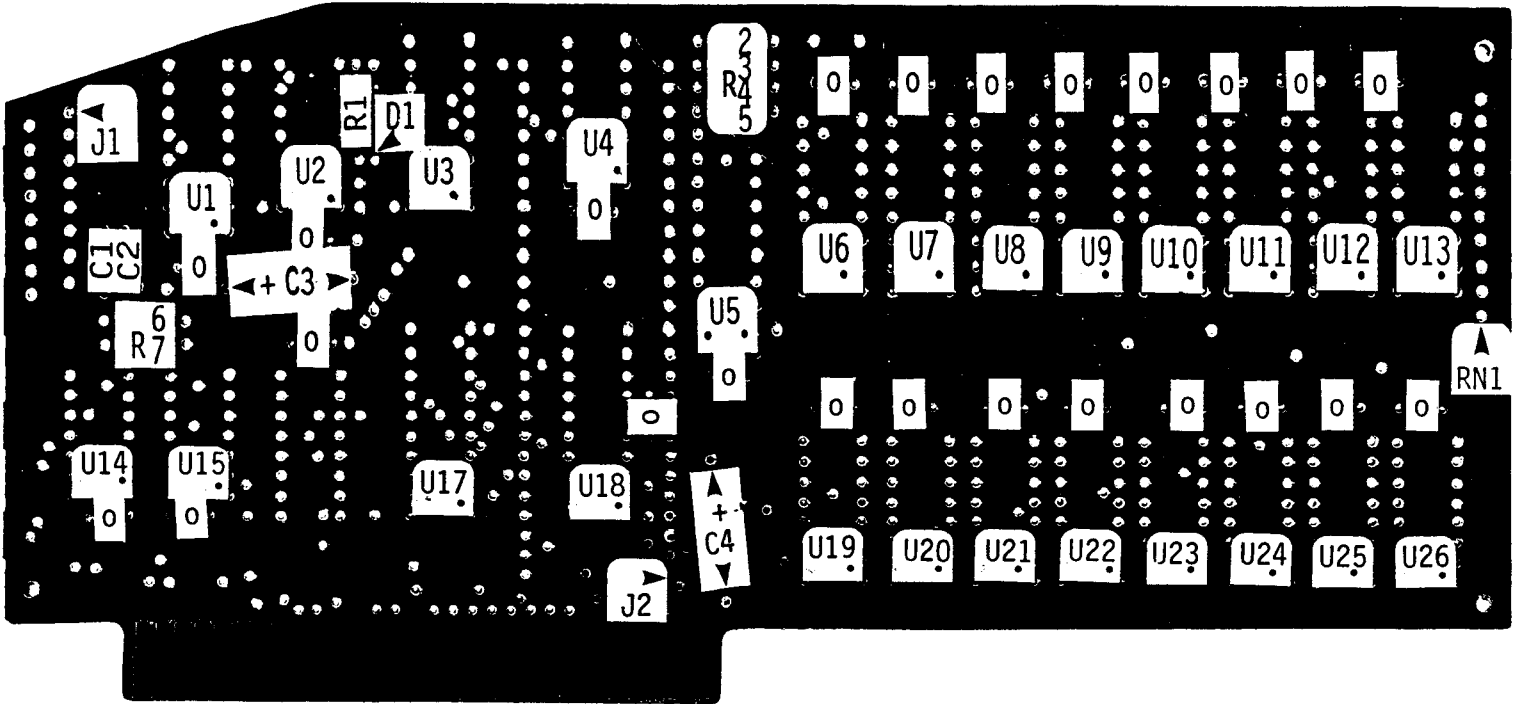

SEQUENCE *INDICATES A PRECAUTION *MODIFICATION REQUIRED ON COMPONENT SIDE

MODIFICATION REQUIRED ON THE COMPONENT SIDE: Cut trace between pin 13 of U15 and the nearest plate-thru hole

DIODES * Position banded end (cathode) of diode towards the arrow
 _____ 1 - 1N4148 @ D1 *Shortest distance

RESISTORS R ¼ watt, 5%
 _____ 5 - 56 Ω @ R2,3,4,5,7
 _____ 1 - 270 Ω @ R6
 _____ 1 - 2.2 KΩ @ R1
 _____ 1 - 1 KΩ 10-pin SIP*, bussed @ RN1. *Match pin 1 of SIP with pin 1 (arrow) on layout

SOCKETS *Match pin 1 of sockets with pin 1 on the layout. Check that ALL pins have passed thru ALL holes
 _____ 4 - 14-pin
 _____ 19 - 16-pin
 _____ 3 - 20-pin

CAPACITORS C
 _____ 2 - 22 pF @ C1,2
 _____ 24 - 0.1 μF Monolithic @ .0.
 _____ 2 - 10 μF/16V Axial* @ C3,4
 * Match + of Axial with + on the layout

HEADERS female, install on component side
 _____ 1 - 1x8 @ J1
 _____ 1 - 1x24 @ J2 for 512 Add-on card

INTEGRATED CIRCUITS *Match pin 1 of ICs with pin 1 on the layout
 _____ 1 - 74LS00 @ U15
 _____ 1 - 74LS08 @ U2
 _____ 1 - 74LS32 @ U4
 _____ 1 - 74LS51 @ U14
 _____ 1 - 74LS139 @ U1
 _____ 1 - 74LS173 @ U3
 _____ 1 - 74LS175 @ U16
 _____ 1 - 74LS245 @ U17
 _____ 1 - 74LS373 @ U5
 _____ 1 - 74LS374 @ U18
 _____ 16 - 41256 DRAM 150 ns @ U 6 to 13 @ U19 to 26

MODIFICATION: Cut trace from pin 13 of U15 as shown below

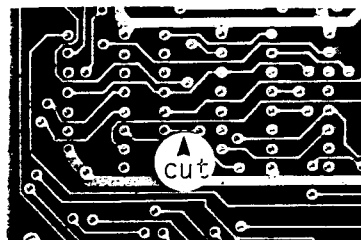

GUIDE 3-1

80-COLUMN CARD: Allows the user to display 80 characters on the video screen.
 With power off, install in slot 3. Requires firmware (2 or 3 EPROMs).

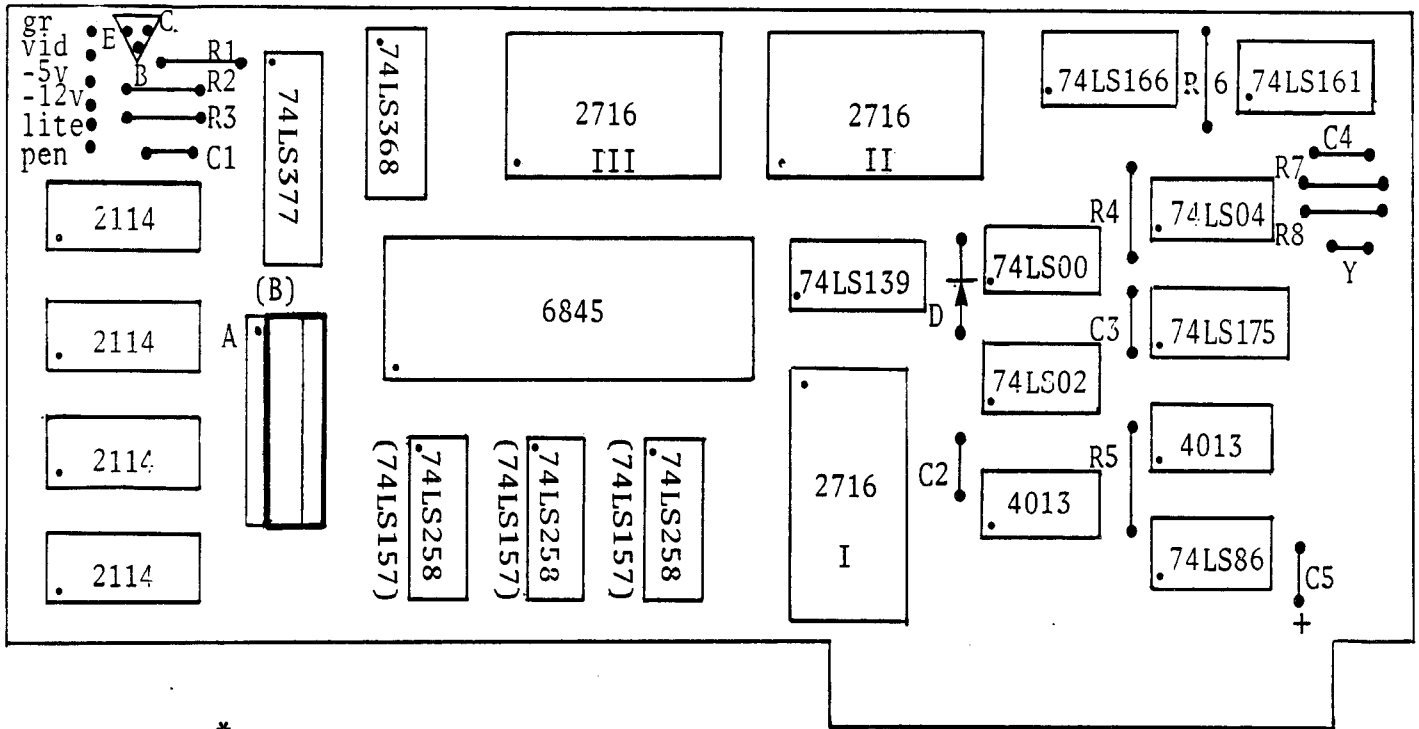

SEQUENCE *INDICATES A PRECAUTION

DIODE D *Position banded end (cathode) of diode as shown

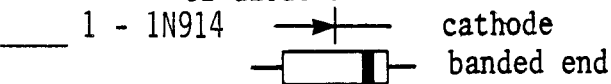

RESISTORS R 1/4 watt, 5%

- 1 - 180 Ω @ R1
 - 1 - 47 Ω @ R2
 - 1 - 20 Ω @ R3
 - 1 - 2.2 KΩ @ R4
 - 1 - 1.5 KΩ @ R5
 - 1 - 1 KΩ @ R6
 - 1 - 220 Ω @ R7,8
-

CAPACITORS C

- 2 - 0.1 μF @ C1,2
 - 1 - 100 pF @ C3
 - 1 - 220 pF @ C4
 - 1 - 10 μF/16v Tantalum* @ C5
- *Match + of capacitor with + on layout
-

SOCKETS *Match pin 1 of socket with pin 1 on layout. Check that ALL pins have passed thru ALL holes

- 6 - 14-pin
 - 8 - 16-pin
 - 4 - 18-pin
 - 2 - 20-pin
 - 3 - 24-pin
 - 1 - 40-pin
-

TRANSISTOR Q *Position EBC leads as shown on the layout

- 1 - 2N3904

CRYSTAL Y

- 1 - 17.430 @ Y *Fold crystal against the card before soldering

HEADER

- 1 - 1x6 male header strip, straight

INTEGRATED CIRCUITS *Match pin 1 of ICs with pin 1 on layout

- 1 - 74LS00
 - 1 - 74LS02
 - 1 - 74LS04
 - 1 - 74LS86
 - 1 - 74LS139
 - 1 - 74LS161
 - 1 - 74LS166
 - 1 - 74LS175
 - 3 - 74LS258 OR (74LS157)
 - 1 - 74LS368
 - 1 - 74LS373 @ A* OR (74LS245 @ B*)
 - 1 - 74LS377
 - 2 - CD4013
 - 3 - 2716 EPROMs
 - 1 - 6845 MPU
 - 4 - 2114 Static RAM
-



GUIDE 3-2

80-COLUMN CARD: Allows user to select 18 or 24 lines of text each of 80 characters; (VK) can display upper or lower case. With power off, install in slot 3. Requires firmware (two or three EPROMS).

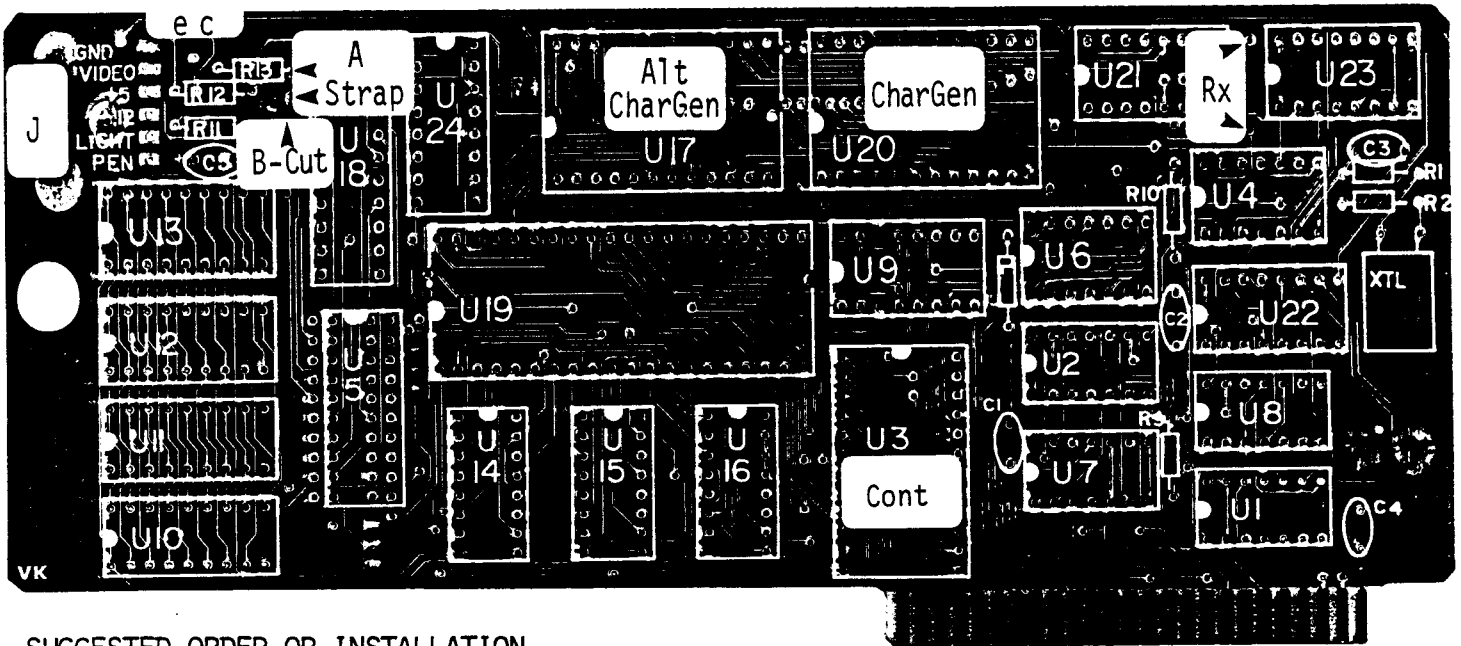

SUGGESTED ORDER OR INSTALLATION

*INDICATES A PRECAUTION

DIODES D * Position banded end (cathode) of diode as shown

- 1 - 1N914  cathode end

RESISTORS R 1/2 watt, 5%

- 1 - 10 Ω @ R13
- 1 - 160 Ω @ R12
- 1 - 200 Ω @ R11
- 2 - 220 Ω @ R1,2
- 1 - 1.5 KΩ @ R9
- 1 - 2 KΩ @ R10
- 1 - 1 KΩ @ Rx *As shown on the layout

SOCKETS *Match pin 1 of sockets with pin 1 on the layout. Check that ALL pins have passed thru ALL holes

- 6 - 14-pin
- 8 - 16-pin
- 4 - 18-pin
- 2 - 20-pin
- 3 - 24-pin
- 1 - 40-pin



CAPACITORS C

- 1 - 100 pF @ C2
- 1 - 1,000 pF @ C4
- 3 - 0.1 μF @ C1,4,5

CONNECTOR

- 1 - 6 pin header, right angle AND/OR

TRANSISTOR Q *Position EBC leads as shown on the layout

- 1 - 2N3904 @ Q

CRYSTAL Y

- 1 - 17.430 MHz @ XTL *Fold body of crystal flat against the board before soldering

INTEGRATED CIRCUITS *Match pin 1 of ICs with pin 1 on the layout

- 1 - 74LS00 @ U6
- 1 - 74LS02 @ U2
- 1 - 74LS04 @ U4
- 1 - 74LS86 @ U1
- 1 - 74LS139 @ U9
- 1 - 74LS161 @ U23
- 1 - 74LS166 @ U21
- 3 - 74LS157 @ U14,15,16
- 1 - 74LS175 @ U22
- 1 - 74LS245 @ U5
- 1 - 74LS368 @ U24
- 1 - 74LS374 @ U18
- 2 - CD4013 @ U7,8
- 1 - 6845 MPU @ U19
- 2 - 2716 EPROMS @ U17,20
- 1 - 2708 EPROM @ U3
- 4 - 2114 Static RAM @ U10,11,12,13

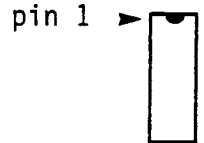

MODIFICATIONS *As shown on the layout @ A & B
A-Strap the two large pads
B-Cut the trace between the two large pads

SPRITE GRAPHICS CARD: Create graphics that can be made to move smoothly & quickly across the screen. With power off, install in slot number 1-5. Reference: High-Resolution Sprite-Oriented Colour Graphics by Steven A Ciarcia; pg. 57; Aug, 1982; BYTE Publications Inc.

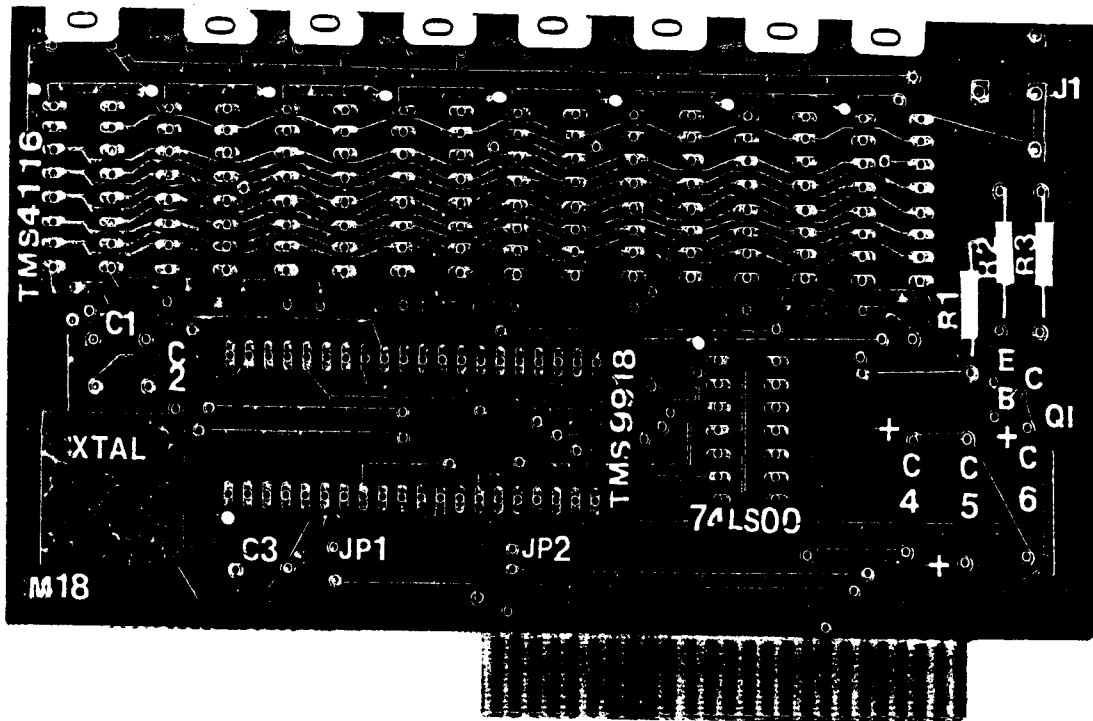

SUGGESTED ORDER OF INSTALLATION

*INDICATES A PRECAUTION

RESISTORS R 1/2 watt, 5%

- 1 - 33 Ω @ R2
- 1 - 330 Ω @ R3
- 1 - 10 KΩ @ R1

SOCKETS *Match pin 1 of sockets with the white dot (pin 1) on the layout. Check that ALL pins have passed thru ALL holes

- 1 - 14-pin
- 8 - 16-pin
- 1 - 40-pin

CAPACITORS C

- 2 - 33 pF disc @ C1,2
 - 1 - 5-50 pF trimcap @ C3
 - 8 - 0.1 μF Monolithic @ positions marked ○ on the layout
 - 3 - 10 μF/16v axial* @ C4,5,6
- *Match + of capacitors with + on the layout

TRANSISTORS Q *Match the three EBC transistor leads with EBC on the layout

- 1 - 2N2222 @ Q1

CRYSTAL Y

- 1 - 10.7386 MHz @ XTAL *Position body of crystal against the card. Insulate the card from crystal with tape

CONNECTOR

- 1 - RCA video jack, PCB mount @ J1

INTEGRATED CIRCUITS *Match pin 1 of IC with pin 1 (white dot) on layout

- 1 - 74LS00
- 8 - TMS4116 RAM
- 1 - TMS9918A colour video display process (T.I.)

pin 1 •  white dot for ALL sockets & ICs



GUIDE 3-4

80-COLUMN/SOFT-SWITCH CARD: Displays 18 or 24 lines of text, each of 80 characters as well as upper and lower case. Automatically switches from 40 to 80 columns with built-in soft-switch. With power off, install in slot 3. Requires firmware (2 or 3 EPROMs).

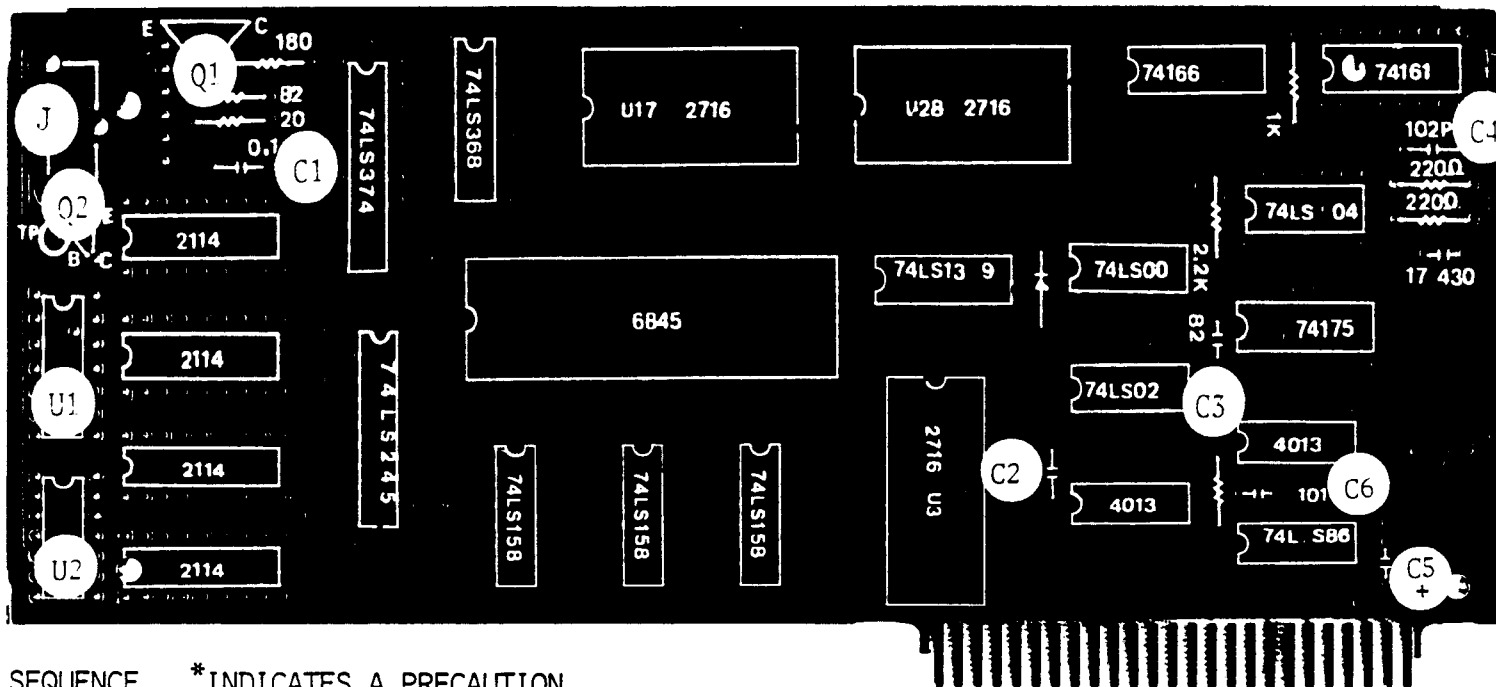

SEQUENCE *INDICATES A PRECAUTION

DIODE *Position banded end (cathode) of diode as shown
 _____ 1 - 1N914

RESISTORS R 1/4 watt, 5%

- _____ 1 - 180 Ω
- _____ 1 - 82 Ω
- _____ 1 - 20 Ω
- _____ 1 - 2.2 KΩ
- _____ 1 - 1.5 KΩ
- _____ 1 - 1 KΩ
- _____ 2 - 220 Ω

CAPACITORS C

- _____ 3 - 0.1 μF @ C1,2,6
- _____ 1 - 82 pF @ C3
- _____ 1 - 0.001 μF @ C4
- _____ 1 - 10 μF/16V Tantalum @ C5 *Match + of capacitor with + on the layout

SOCKETS *Match pin 1 of sockets with pin 1 on the layout. Check that ALL pins have passed thru ALL holes

- _____ 8 - 14-pin
- _____ 8 - 16-pin
- _____ 4 - 18-pin
- _____ 2 - 20-pin
- _____ 3 - 24-pin
- _____ 1 - 40-pin

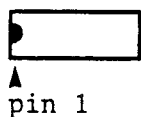

CONNECTORS

- _____ 1 - 6-pin male header, straight AND/OR
- _____ 1 - RCA video jack, PCB mount, @ J
- _____ 1 - 1-pin male header, straight @ TP

TRANSISTOR Q *Position EBC leads as shown on the layout
 _____ 1 - 2N3904 @ Q1

CRYSTAL Y *Insulate crystal & fold it flat against the card before soldering
 _____ 1 - 17.430 @ 17 430

INTEGRATED CIRCUITS * Match pin 1 of ICs with pin 1 on the layout

- _____ 1 - 74LS00
- _____ 1 - 74LS02
- _____ 1 - 74LS04
- _____ 1 - 74LS86
- _____ 1 - 74LS139
- _____ 1 - 74LS161
- _____ 1 - 74LS166
- _____ 1 - 74LS175
- _____ 3 - 74LS158
- _____ 1 - 74LS368
- _____ 1 - 74LS245
- _____ 1 - 74LS374
- _____ 2 - CD4013
- _____ 3 - 2716 EPROMs
- _____ 1 - 6845 MPU
- _____ 1 - 2114 Static RAM

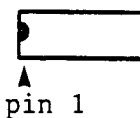

FOR SOFT-SWITCH, INSTALL:

- _____ 1 - 2N3904 @ Q2
- _____ 1 - 74LS125 @ U1
- _____ 1 - 74LS74 @ U2

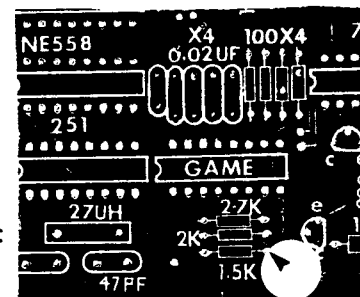

MOTHERBOARD @ H-14

Connect an insulated wire from TP of card to resistors near game port on the motherboard

GUIDE 3-5

80 COLUMN (IIE): Add 80 column text to the motherboard. With power off, install in the "auxilliary" slot.

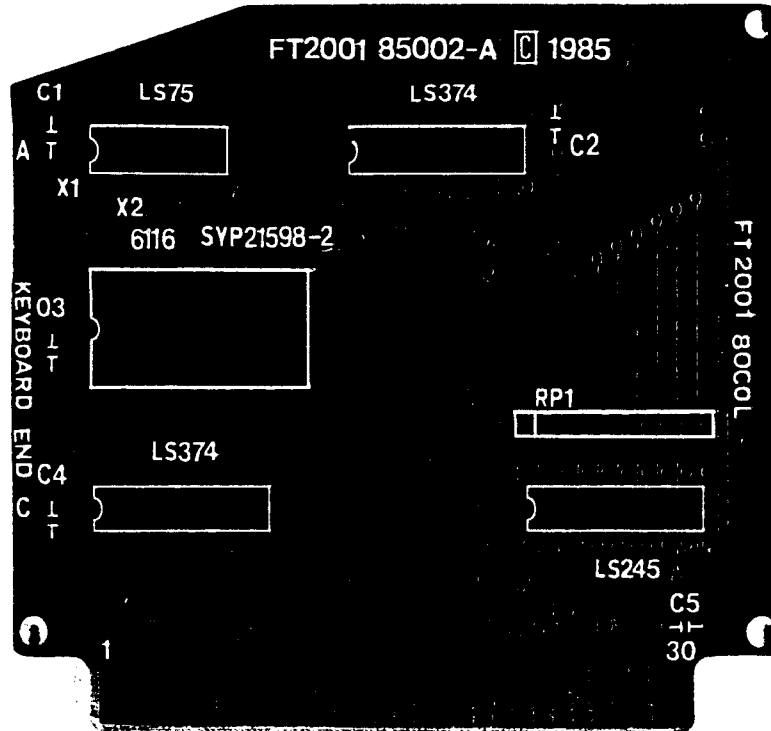

SEQUENCE *INDICATES A PRECAUTION

RESISTORS R $\frac{1}{4}$ watt, 5%

- _____ 1 - 3.3 K Ω 10-pin SIP* bussed @ RP1
- *Match pin 1 of SIP with pin 1 (square) on the layout

SOCKETS *Match pin 1 of sockets with pin 1 (square pad) on the layout. Check that ALL pins have passed thru ALL holes before soldering

- _____ 1 - 16-pin
 - _____ 3 - 20-pin
 - _____ 1 - 24-pin
- ▲ pin 1

CAPACITORS C
_____ 5 - 0.1 μ F Monolithic @ C1,2,3,4,5

INTEGRATED CIRCUITS *Match pin 1 of ICs with pin 1 on the layout

- _____ 1 - 74LS75
- _____ 1 - 74LS245
- _____ 2 - 74LS374
- _____ 1 - 6116

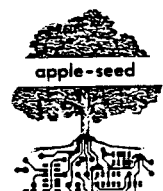

GUIDE 3-6

80 COLUMN/64K EXPANDER (IIE): Provides 80 column text as well as 64 K bytes of RAM memory to the motherboard. With power off, install in the special "auxilliary" slot.

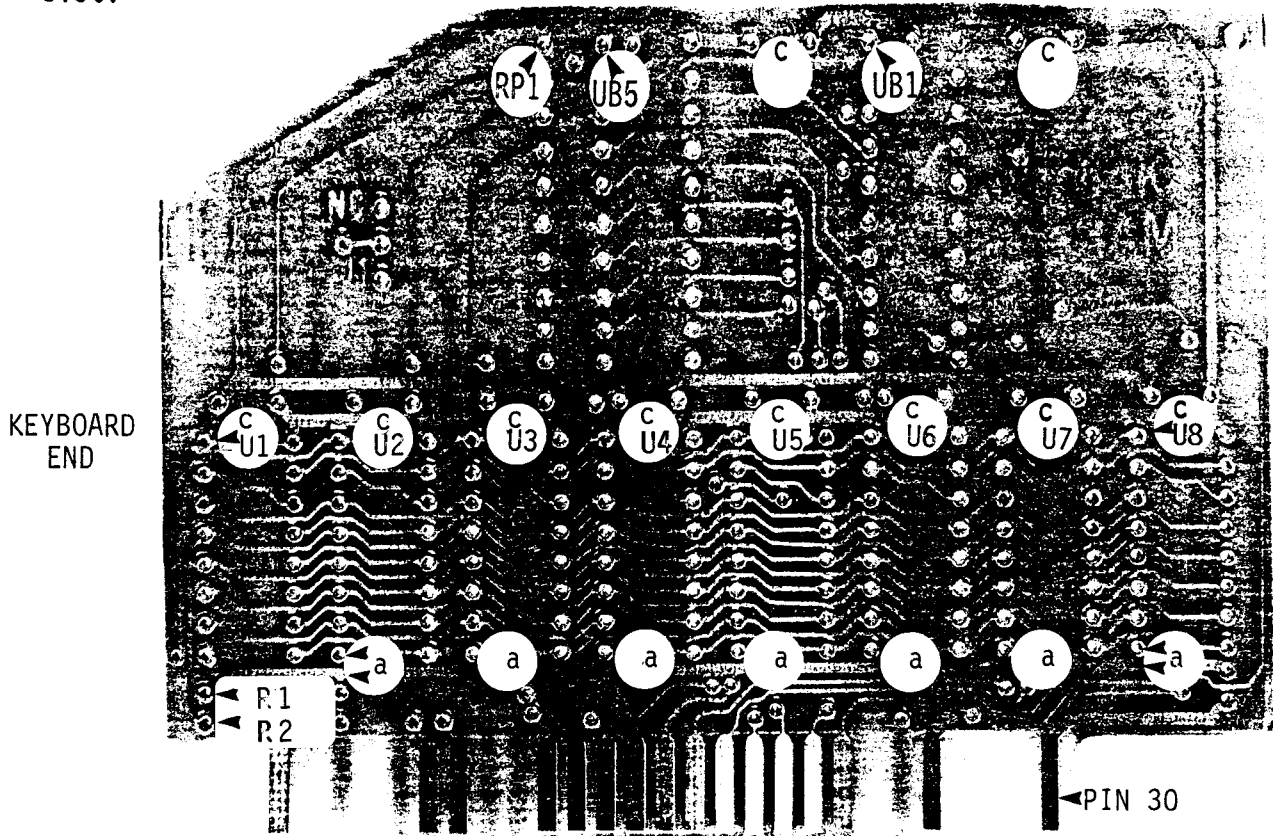

Layout is magnified

SEQUENCE *INDICATES A PRECAUTION *SOME CARDS MAY REQUIRE MODIFICATION AT "a"

*MODIFICATION: At "a" strap pin 8 of each of U2,3,4,5,6,7,8 to bus bar connecting to pin 30 (+5V) of card edge connector as shown.

HEADER

___ 1 - 1x3 male, straight @ J1

RESISTORS R ¼ watt, 5%

- ___ 2 - 47 Ω @ R1,2
 - ___ 1 - 3.3 KΩ 10-pin SIP* bussed @ RP1
- *Pin 1 is indicated by the arrow

SOCKETS *Match pin 1 of sockets with pin 1 (arrow) on the layout. Check that ALL pins have passed thru ALL holes.

- ___ 8 - 16-pin
- ___ 2 - 20-pin

CAPACITORS C

- ___ 10 - 0.1 μF Monolithic @ "c"

INTEGRATED CIRCUITS *Match pin 1 of ICs with pin 1 (arrow) on the layout

- ___ 1 - 74LS245 @ UB5
- ___ 1 - 74LS374 @ UB1
- ___ 8 - 4164 RAM @ U1 2 3 4 5 6 7 8

NuScope Associates



GUIDE 3-7

COLLEGE 80 COLUMN/64 K CARD (IIe): Add an additional 64 K bytes of RAM memory to the motherboard as well as 80 column text. With power off, install in the "auxilliary" slot.

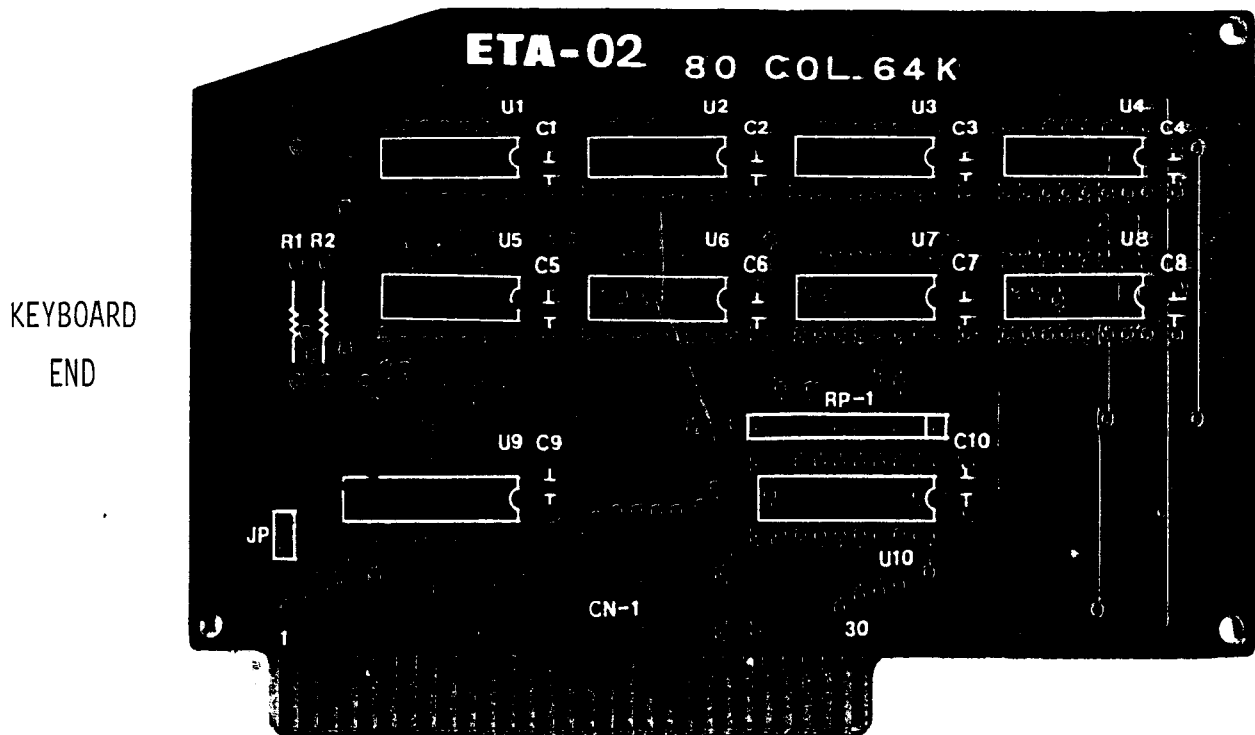

SEQUENCE *INDICATES A PRECAUTION

RESISTORS R ¼ watt, 5%

- 2 - 47 Ω @ R1,2
- 1 - 3.3 KΩ 10-pin SIP* bussed @ RP-1
- *Match pin 1 of SIP with pin 1 (square) on the layout

SOCKETS *Match pin 1 of sockets with pin 1 on the layout. Check that ALL pins have passed thru ALL holes

- 8 - 16-pin
- 2 - 20-pin



CAPACITORS C

- 10 - 0.1 μF Monolithic @ C1 to C10

HEADER

- 1 - 1x2 header, straight, male @ JP

INTEGRATED CIRCUITS *Match pin 1 of ICs with pin 1 on the layout

- 1 - 74LS245 @ U10
- 1 - 74LS374 @ U9
- 8 - 4164 RAM @ U1,2,3,4,5,6,7,8

NuScope Associates

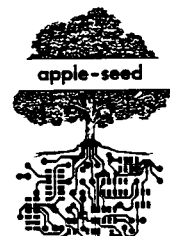

GUIDE 3-8

JK 80 COLUMN/64K CARD: Provides 80-column text as well as 64 K bytes of RAM memory to the motherboard. With power off, install in the special "auxilliary" slot.

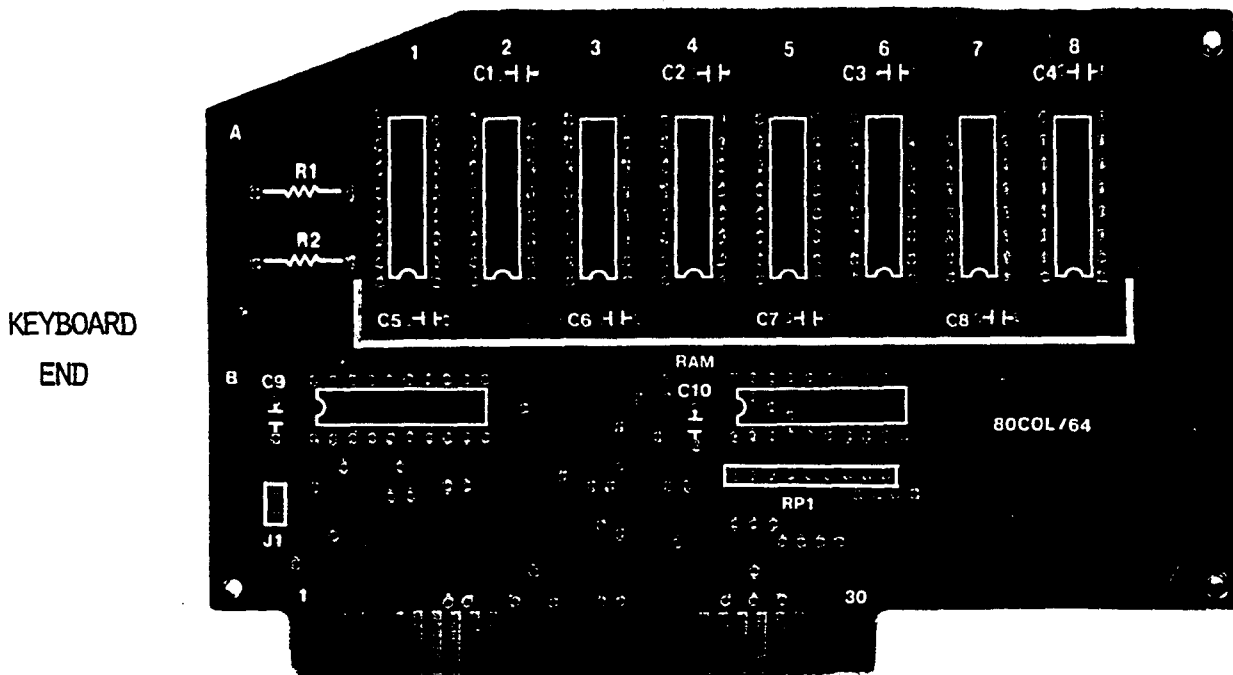

SEQUENCE *INDICATES A PRECAUTION

RESISTORS R $\frac{1}{4}$ watt, 5%

- 2 - 47 Ω @ R1,2
- 1 - 3.3 K Ω 10-pin SIP* bussed @ RP1
*Match pin 1 of SIP with pin 1 (square) on the layout

SOCKETS *Match pin 1 of sockets with pin 1 on the layout. Check that ALL pins have passed thru ALL holes

- 8 - 16-pin
- 2 - 20-pin

CAPACITORS C

- 10 - 0.1 μ F Monolithic @ C1 to C10

HEADER

- 1 - 1x2 straight, male @ J1

INTEGRATED CIRCUITS *Match pin 1 of ICs with pin 1 on the layout

- 1 - 74LS245 @ B-5
- 1 - 74LS374 @ B-1
- 8 - 4164 RAM @ A-1 to A-8

NuScope Associates



Z 80 CARD: Allows one to run software written for the Z 80 based microcomputer (CP/M operating system). With power off, install in slot number 4.

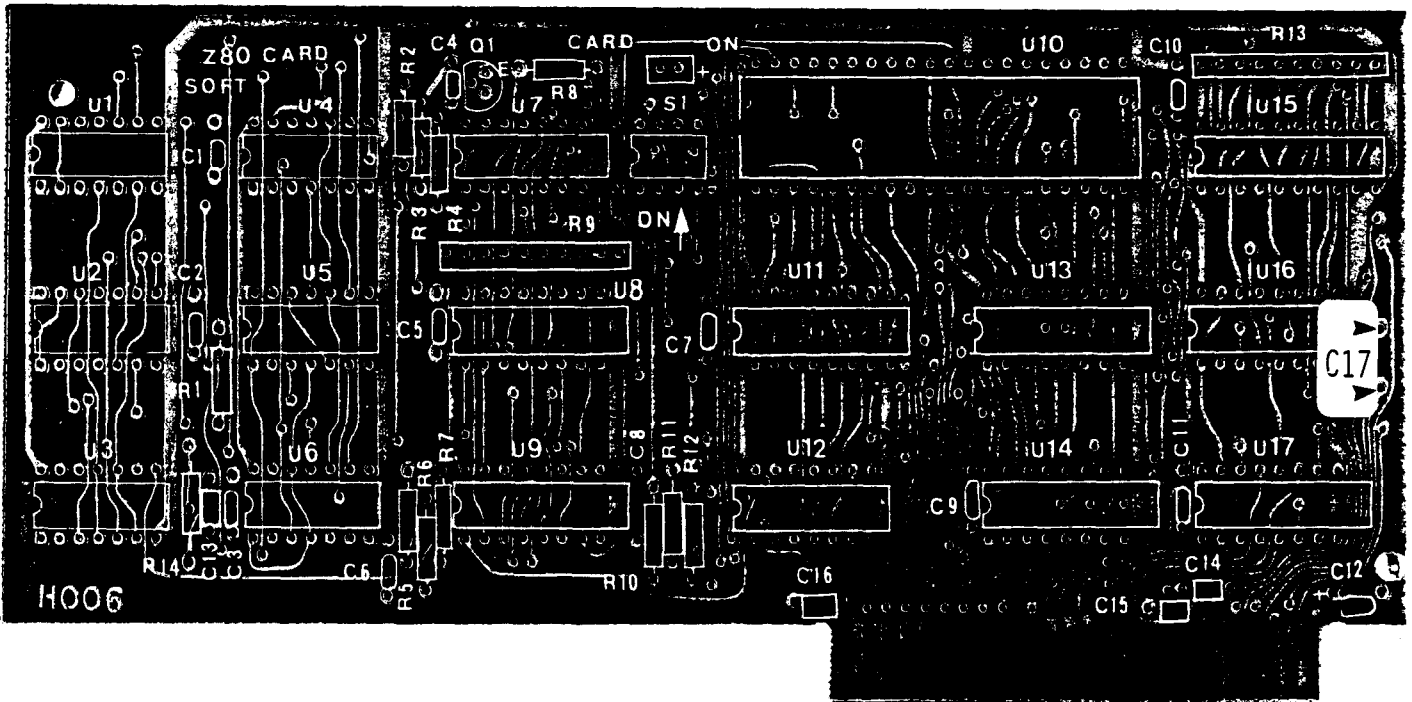

SEQUENCE *INDICATES A PRECAUTION

RESISTORS R ¼ watt, 5%

- _____ 1 - 2.2 KΩ @ R1
- _____ 1 - 27 Ω @ R2
- _____ 1 - 220 Ω @ R3
- _____ 2 - 1 KΩ @ R4,14
- _____ 4 - 100 Ω @ R5,6,11 12
- _____ 2 - 4.7 KΩ @ R7,10
- _____ 1 - 680 Ω @ R8
- _____ 2 - 10 KΩ SIP @ R9,13

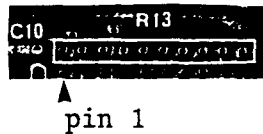

CAPACITORS C

- _____ 11 - 0.1 μF @ C1,2,3,5,7,9,10
11,14,15,16
 - _____ 1 - 50 pF @ C4
 - _____ 3 - 220 pF @ C6,8,13
 - _____ 1 - 4.7 μF/25v Tantalum @ C12
- *match + of capacitor with + on layout

SOCKETS *Match pin 1 of socket with pin 1 on layout. Check that ALL pins have passed thru ALL holes.

- _____ 8 - 14-pin
- _____ 7 - 16-pin
- _____ 1 - 20-pin
- _____ 1 - 40-pin

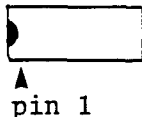

TRANSISTOR Q *Install 3 leads as shown.

- _____ 1 - 2N3906
- *Check with supplier

LIGHT EMITTING DIODE

- _____ 1 - LED *position longer lead (+) as shown on layout



SWITCH S1

- _____ 1 - 4-position DIP
- Functions:
- 1 - address offset when off
 - 2 - Z80 DMA when on
 - 3 - non-maskint when on
 - 4 - Z80 interrupts when on

INTEGRATED CIRCUITS * match pin 1 of IC with pin 1 on layout

- _____ 1 - 74LS00 @ U1
- _____ 1 - 74LS05 @ U2
- _____ 1 - 74LS32 @ U3
- _____ 1 - 74S20 @ U12
- _____ 2 - 74LS74 @ U5,6
- _____ 1 - 74LS86 @ U7
- _____ 1 - 74LS107 @ U4
- _____ 1 - 74LS138 @ U11
- _____ 1 - 74LS283 @ U8
- _____ 5 - 74LS367 @ U9,13,14,16,17
- _____ 1 - 74LS373 @ U15
- _____ 1 - Z80A @ U10

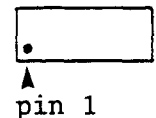

GUIDE 4-2

8 CARD: Accesses the 64K bytes of the computer's memory. The 8088 (16-bit word size) and the 6502 (8-bit) can both run simultaneously to provide faster execution speed of existing programs. Allows development of programs that will run on the 8088 microprocessor. With power off, install in any slot except 0. Requires 64K bytes of RAM, firmware (one EPROM), and software (one disk).

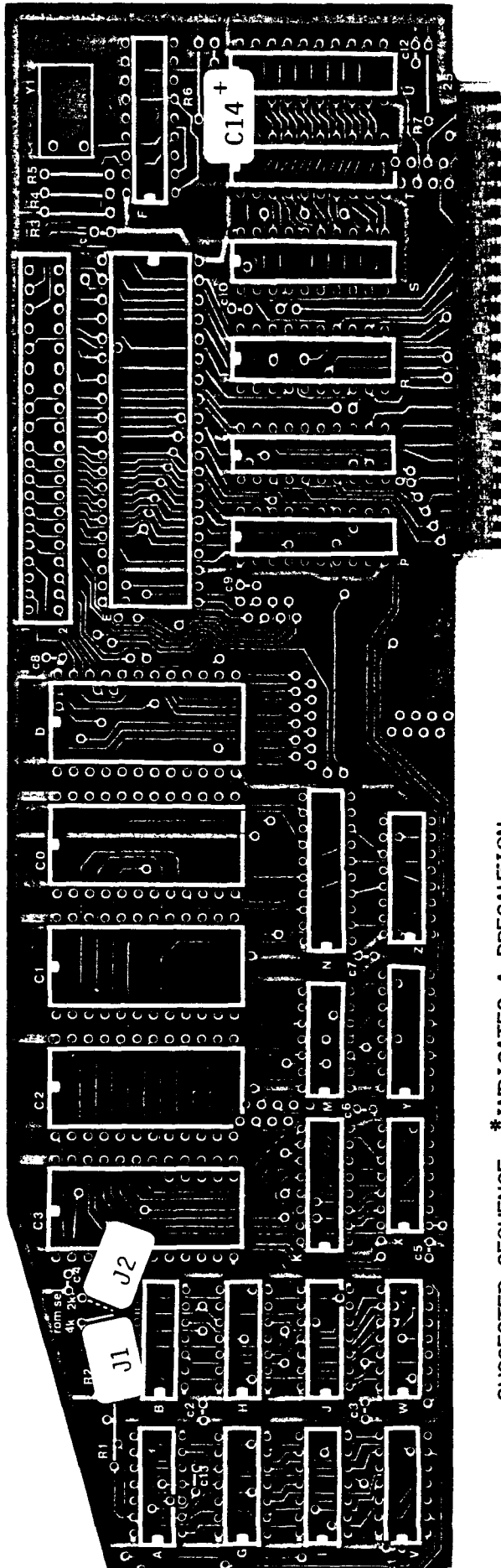

SUGGESTED SEQUENCE *INDICATES A PRECAUTION

- RESISTORS R 1/4 watt, 5%
 4 - 2 KΩ @ R1,2,3,7
 2 - 510 Ω @ R4,5
 1 - 5.6 KΩ @ R6

- SOCKETS *Match pin 1 of sockets with pin 1 on the layout. Check that ALL pins have passed thru ALL holes

- 10 - 14-pin
- 3 - 16-pin
- 1 - 18-pin
- 7 - 20-pin
- 5 - 24-pin
- 1 - 40-pin

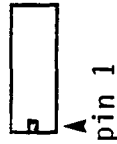

CAPACITORS C @ Positions labelled ●—● on the layout

- 1 - 0.001 μF @ C13
- 12 - 0.1 μF @ C1,2,3,4,5,6,7,8,9,10,11,12
- 1 - 6.8 μF/16V Tantalum* @ C14 *Match + of capacitor with + on the layout

CONNECTOR

- 1 2x20 female header strip, straight

JUMPER

- 1 - Refer to layout: J1 for 2732A 4K EPROM) @ rom set OR J2 for 2716 2K EPROM)

CRYSTAL Y

- 1 - 15.000 MHz @ Y1 *Fold crystal flat against the card before soldering

EK Z80-CARD: Allows one to use the CP/M operating system with the Z80 microprocessor installed. With power off, install in slot number 4.

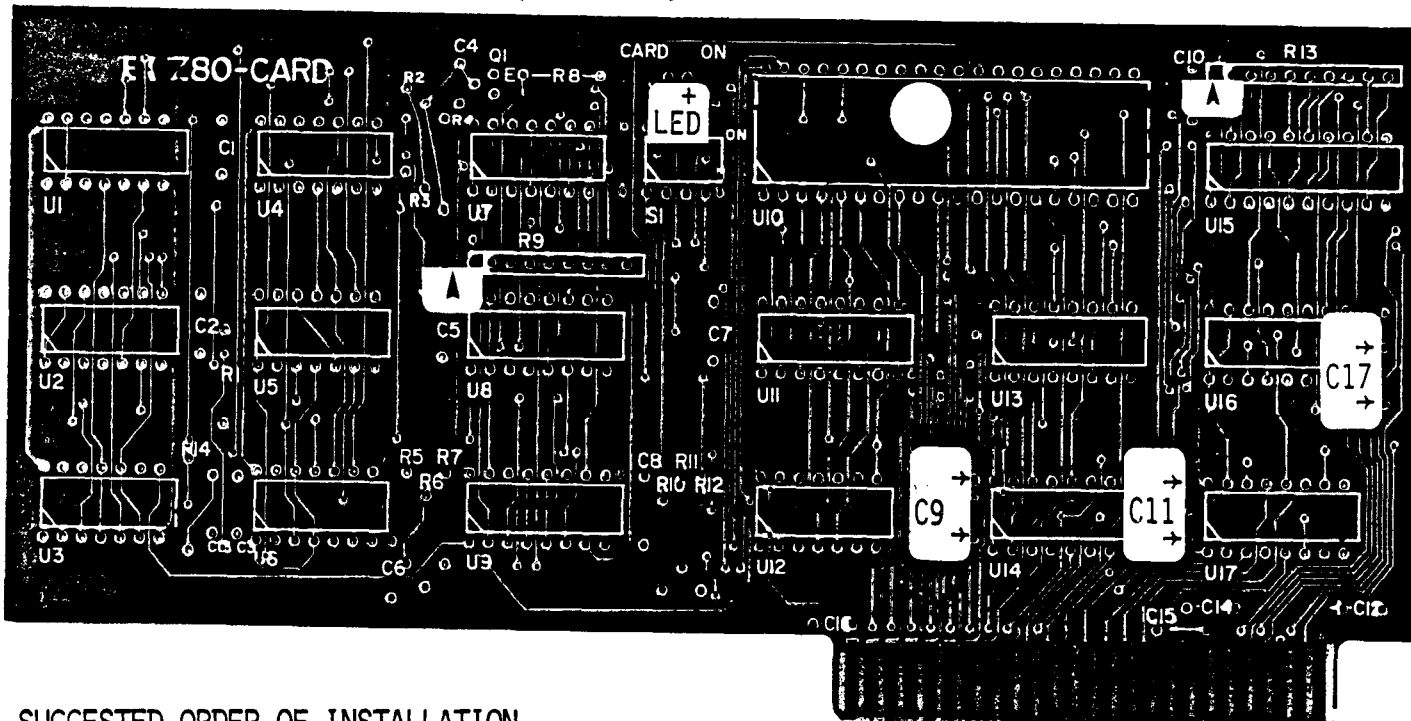

SUGGESTED ORDER OF INSTALLATION

*INDICATES A PRECAUTION

RESISTORS 1/4 watt, 5%

- 1 - 2.2 KΩ @ R1
- 1 - 22 Ω @ R2
- 1 - 220 Ω @ R3
- 1 - 1.2 KΩ @ R4
- 5 - 100 Ω @ R5,6,11,12,14
- 2 - 4.7 KΩ @ R7,10
- 1 - 680 Ω @ R8
- 2 - 10 KΩ SIP, 10-pin @ R9,13 *Position pin 1 of SIPs as shown on the layout

CAPACITORS C

- 11 - 0.1 μF Monolithic @ C1,2,3,5,7,9,10, C11,14,15,16
- 2 - 47 pF @ C4,17
- 3 - 200 pF @ C6,8,13
- 1 - 2.2 μF/35V Tantalum* @ C12 *Match + of capacitor with + on the layout

SOCKETS *Match pin 1 of sockets with pin 1 on the layout. Check that ALL pins have passed thru ALL holes.

- 8 - 14-pin
 - 7 - 16-pin
 - 1 - 20-pin
 - 1 - 40-pin
- pin 1 lower left for ALL sockets

TRANSISTOR Q *Install EBC leads as shown

- 1 - 2N3906
- Q1
E
B
C

LIGHT EMITTING DIODE LED

- 1 - LED @ CARD ON *Position longer lead (+) as shown on the layout

SWITCH

- 1 - DIP switch, 4-position @ S1
- Functions: 1-address offset when off
2-Z80 DMA when on
3-non-mask int when on
4-Z80 interrupts when on

INTEGRATED CIRCUITS *Match pin 1 of ICs with pin 1 on the layout

- 1 - 74LS00 @ U1
- 1 - 74LS05 @ U2
- 1 - 74LS32 @ U3
- 1 - 74S20 @ U12
- 2 - 74LS74 @ U5,6
- 1 - 74LS86 @ U7
- 1 - 74LS107 @ U4
- 1 - 74LS138 @ U11
- 1 - 74LS283 @ U8
- 5 - 74LS367 @ U9,13,14,16,17
- 1 - 74LS373 @ U15
- 1 - Z80A @ U10

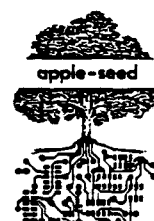

8088 CARD (continued)

INTEGRATED CIRCUITS *Match pin 1 of ICs with pin 1 on the layout



pin 1

- 1 - 74LS14 @ X
- 1 - 74LS00 @ A
- 1 - 74LS04 @ G
- 1 - 74LS10 @ I
- 1 - 74LS27 @ V
- 1 - 74LS32 @ J
- 3 - 74LS74A @ B,H,M
- 1 - 74LS125 @ W
- 1 - 74LS139 @ K
- 2 - 74LS375 @ Y,Z
- 4 - 74SC244 @ N,Q,R,S
- 3 - 74SC373 @ P,T,U
- 1 - 8088 @ E MPU
- 1 - 8284 @ F Clock Generator and Driver
- 1 - EPROM 350 ns @ D *Refer to the layout

MODIFICATIONS TO THE SOLDER SIDE as shown on the layout
Connect jumper wires ON THE SOLDER SIDE as illustrated

- | | |
|--------|--------|
| A to A | k to k |
| B-B | l-l |
| C-C | m-m |
| D-D | n-n |
| E-E | r-r |
| F-F | s-s |
| G-G | t-t |
| H-H | u-u |

FURTHER MODIFICATION

Strap pin 13 to pin 14
on IC number M on the
SOLDER SIDE

and

Strap J1 when using 2732A EPROM
Strap J2 when using 2716 EPROM

MODIFICATIONS TO THE SOLDER SIDE

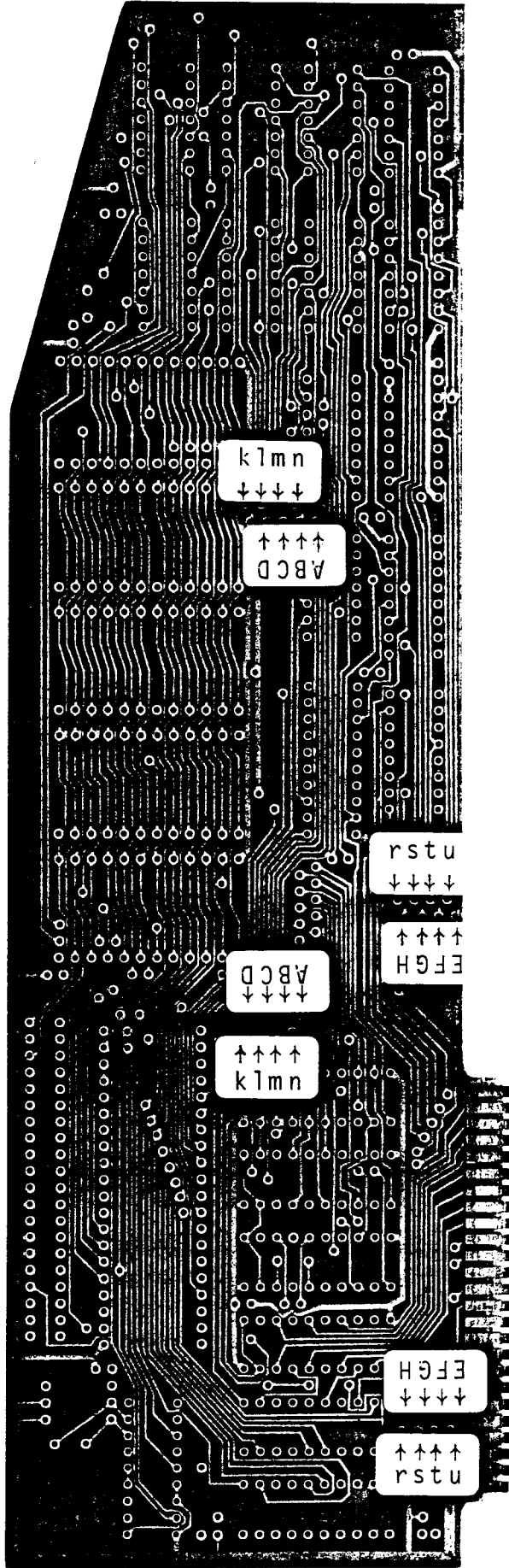

Z80/64K CARD: Allows one to run software written for the Z-80 based microcomputer (CP/M operating system); expands on-board memory by 64 K. With power off, install in slot number 4. Requires firmware (one EPROM) and software (three disks).

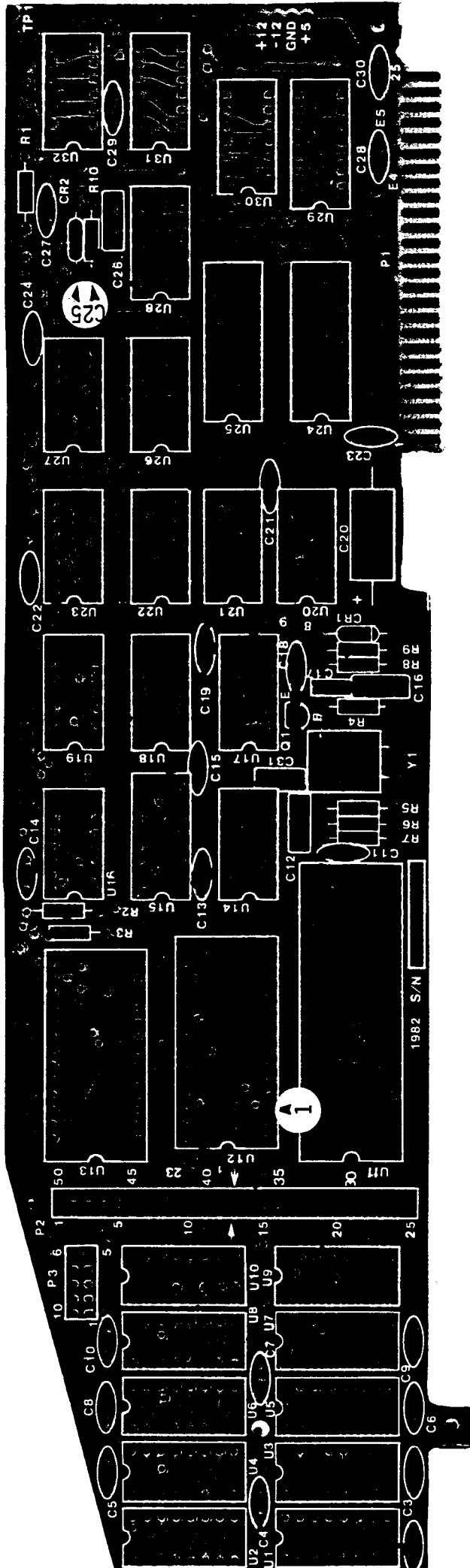

SEQUENCE *INDICATES A PRECAUTION

- DIODES** D *Match banded end (cathode) of diode with the bar on the layout
 1 - 1N4148 @ CR1 *Delete CR2
 2 - 1N4148 @ CR1 *Delete CR2
- RESISTORS** R ¼ watt, 5% *Delete R1,10
 1 - 27 Ω @ R7
 2 - 1 KΩ @ R5,6
 2 - 4.7 KΩ @ R2,3
 2 - 10 KΩ @ R8,9
 1 - 82 KΩ @ R4
- SOCKETS** *Match pin 1 of sockets with pin 1 on the layout. Check that ALL pins have passed thru ALL holes
 15 - 14-pin
 12 - 16-pin
 2 - 20-pin
 2 - 24-pin
 1 - 40-pin

- CAPACITORS** C *Delete C31
 2 - 47 pF @ C25,26
 2 - 33 pF @ C16,17
 1 - 0.01 μF @ C12
 24 - 0.1 μF Monolithic @ C1,2,3,4, C5,6,7,8,9,10,11,13,14,15, C18,19,21,22,23,24,27,28, C29,30
 1 - 100 μF/16V Axial* @ C20
 *Match + of Axial with + on the layout
- CRYSTAL** *Fold crystal flat against the card before soldering
 1 - 12.000 MHz @ Y1

- TRANSISTORS** Q *Match the EBC transistor terminals with EBC on the layout
 1 - 2N2907 @ Q1
- CONNECTORS**
 1 - 25x2 male header, straight @ P2
 1 - 5x2 male header, straight @ P3
 1 - jumper plug: connect pin 13 to pin 38 of P2



NuScope Associates

10/64 K CARD (continued)

INTEGRATED CIRCUITS *Match pin 1 of

ICs with pin 1 on the layout

- 1 - 74LS00 @ U18
- 2 - 74LS04 @ U14, 19
- 1 - 74LS08 @ U32
- 1 - 74ALS11 @ U23
- 2 - 74LS32 @ U16, 28
- 4 - 74LS74 @ U17, 22, 27, 30
- 1 - 74LS125 @ U31
- 1 - 74LS132 @ U21
- 2 - 74LS138 @ U15, 29
- 2 - 74LS158 @ U9, 10
- 2 - 74LS374 @ U24, 25
- 1 - 74LS393 @ U26



- 1 - 74121 @ U20
- 8 - 4164 RAM, 150 ns
@ U1, 2, 3, 4, 5, 6, 7, 8
- 1 - Z80B CPU, 6 MHz @ U11
- 1 - Z80B CTC, 6 MHz @ U13 (optional)
- 1 - 2716 EPROM* @ U 12

*Note position of

pin 1 on the layout

GUIDE 4-5

Z 80+ CARD: Allows user to run software written for the Z 80 based MPU (CP/M operating system). With power off, install in slot number 4.

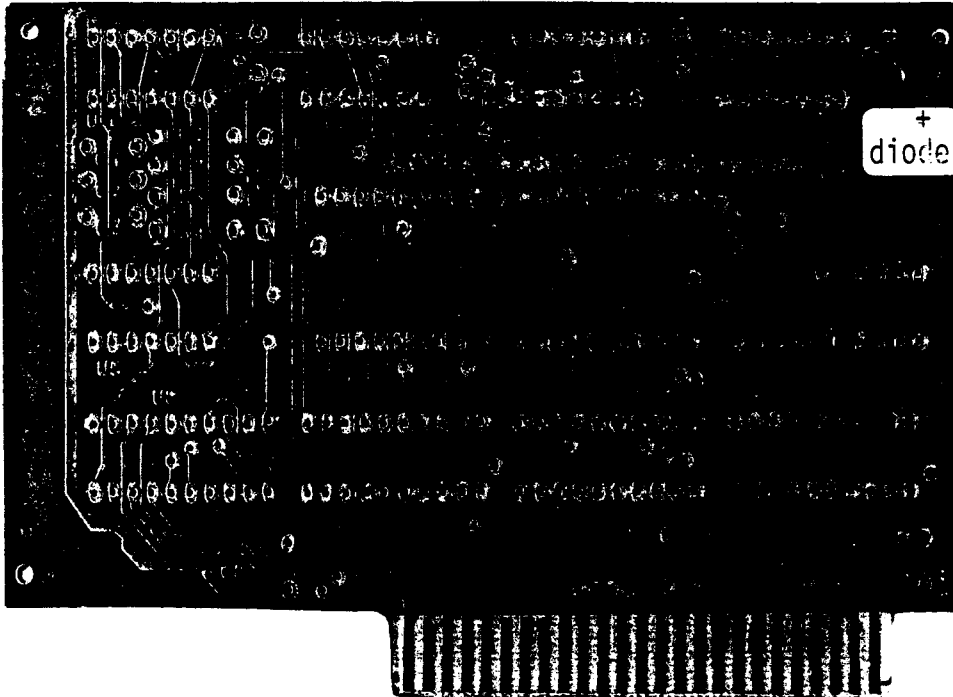

*MODIFICATION REQUIRED:
Cut connection (short)
between pin 2 & pin 3
of U6 on the SOLDER SIDE

SEQUENCE *INDICATES A PRECAUTION

RESISTORS R ¼ watt, 5%

- _____ 1 - 27 Ω @ R5
- _____ 3 - 82 Ω @ R3,4,6
- _____ 1 - 220 Ω @ R2
- _____ 1 - 12 KΩ @ R1
- _____ 2 - 1 KΩ 10-pin SIP* @ RP1,2
*Match pin 1 of SIPs
with pin 1 on the layout

SOCKETS *Match pin 1 of sockets with pin 1 on the layout. Check that ALL pins have passed thru ALL holes

- _____ 6 - 14-pin
- _____ 3 - 20-pin
- _____ 1 - 40-pin

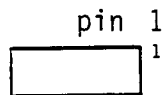

CAPACITORS C

- _____ 1 - 37 pF @ C1
- _____ 1 - 100 pF @ C3
- _____ 2 - 200 pF @ C2,7
- _____ 3 - 0.1 μF Monolithic @ C4,5,8
- _____ 1 - 10 μF/16V Tantalum* @ C6
*Match + of Tantalum
with + on the layout

TRANSISTOR Q *Position EBC transistor leads as shown

- _____ 1 - 2N3904 @ Q1

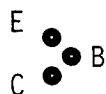

DIODE D

- _____ 1 - LED *Position longer lead (anode) of diode as shown @ D1

INTEGRATED CIRCUITS *Match pin 1 of ICs with pin 1 on the layout

- _____ 1 - 7404 @ U7
- _____ 1 - 7410 @ U3
- _____ 2 - 7474 @ U4,5
- _____ 1 - 74107 @ U1
- _____ 1 - 74125 @ U2
- _____ 2 - 74LS245 @ U9,10
- _____ 1 - 74LS374 @ U8
- _____ 1 - Z80A MPU @ U6
- _____ 1 - 28L22 PROM @ U11

NuScope Associates



SPEEDY CARD: Uses the sophisticated 6502-C microprocessor to considerably increase the speed of the computer. Install in slot 1 to 7. Documentation available from the supplier. Modification required.

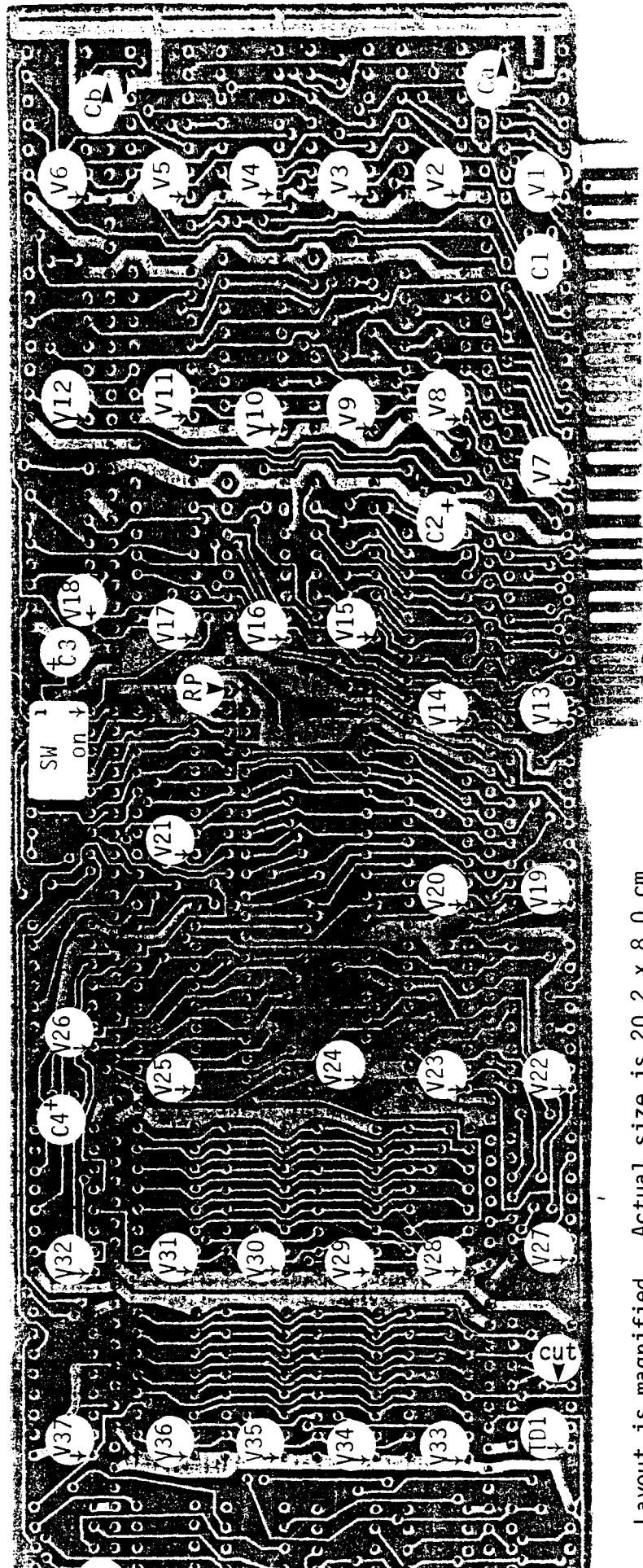

Layout is magnified. Actual size is 20.2 x 8.0 cm

***INDICATES A PRECAUTION *MODIFICATION REQUIRED ON COMPONENT SIDE UNDER TD1**

- *Match pin 1 of sockets with RESISTORS R 1/4 watt, 5%
 - 1 (arrow) on the layout. 1 - 2.2 K Ω 10-pin SIP* bussed @ RP
 - *Match pin 1 of SIP with pin 1 (arrow) on the layout
 - *ALL holes
 - 40-pin @ V24
 - 20-pin @ V7, 13, 14, 25
 - 16-pin @ V9, 10, 15, 16, 17, 19, 20, V21, 22, 23, 28, 29, 30, 31, V32, 33, 34, 35, 36, 37
 - 14-pin @ V1, 2, 3, 4, 5, 6, 8, 11, 12, V18, 26, 27, 38, 39, 40, 41, V42, 43
- CAPACITORS C**
- 1 - 0.1 μ F Monolithic @ C1
 - 3 - 4.7 μ F/16V Tantalum* @ C2, 3, 4
 - *Match + of Tantalum with + on the layout
 - 2 - 72-pin SIP capacitor between Ca, Cb Rogers Q/PAC
- SWITCH**
- 1 - 8-position DIP @ SW
 - *Note the "on" position
- INTEGRATED CIRCUITS *Match pin 1 of ICs with pin 1 on the layout**
- 2 - 74LS00 @ V6, 18
 - 2 - 74LS02 @ V11, 43
 - 2 - 74LS08 @ V12, 26
 - 1 - 74LS10 @ V3
 - 1 - 74LS14 @ V8
 - 1 - 74LS32 @ V5



SPEEDY CARD (continued)

TESTED CIRCUITS (continued)

- 74LS74 @ V1,2,4,38,39,40
- 74LS00 @ V41, 74LS86
- 74LS153 @ V21
- 74LS158 @ V19,20,22,23
- 74LS161 @ V10
- 74LS175 @ V32
- 74LS259 @ V17
- 74LS367 @ V15,16
- 74LS373 @ V7,13,14,25
- 74LS393 @ V27,42
- 4040 @ V37
- 24S10 PROM @ V9
- G65SC02P1-2 MPU @ V24
- 4164 RAM 150 ns @ V28,29,30,31
V33,34,35,36

LINE

- TTLDM-100 100 ns @ TDI

NOTATION ON COMPONENT SIDE:

- cut trace from pin 4 of TTLDM-11 as shown on the layout

GUIDE 4-7

ACE Z-80: Allows one to run software written for the Z-80 based MPU (CP/M operating system). With power off, install in slot 4.

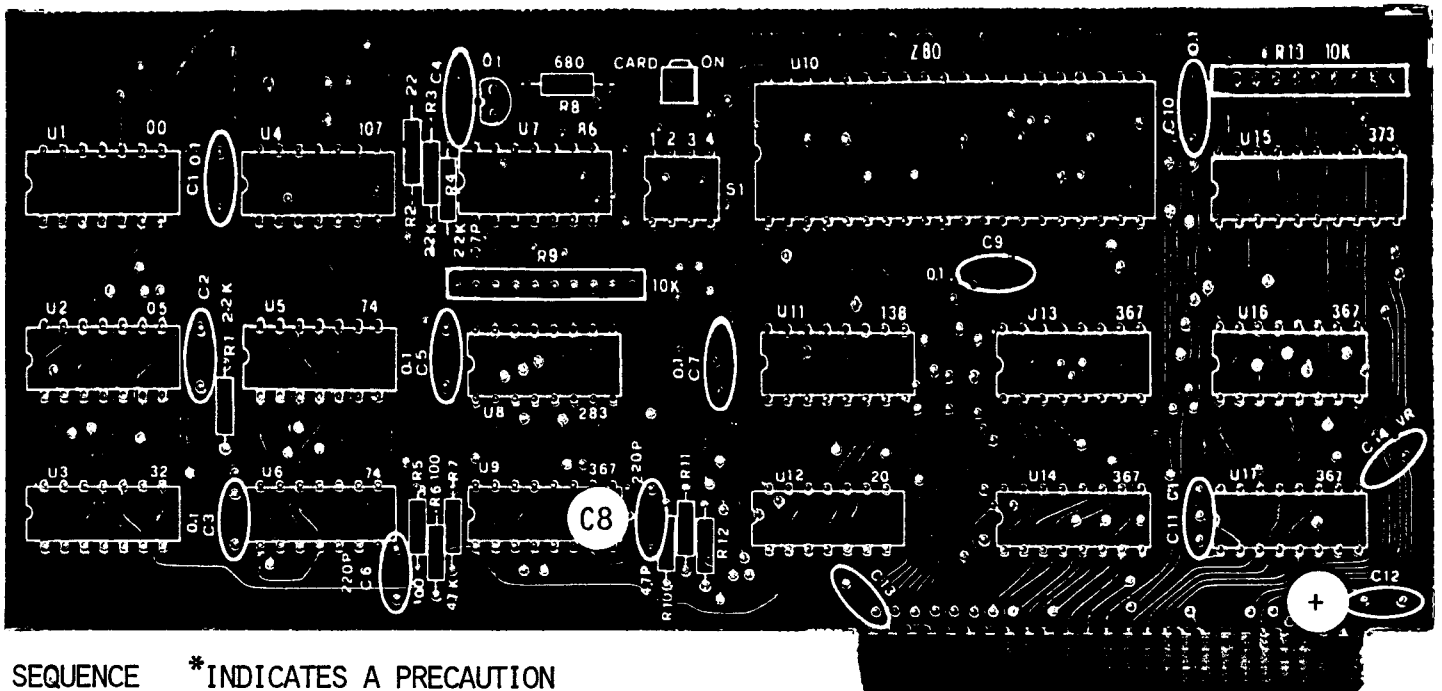

SEQUENCE *INDICATES A PRECAUTION

RESISTORS R 1/2 watt, 5%

- _____ 1 - 22 Ω @ R2
- _____ 4 - 100 Ω @ R5,6,11,12
- _____ 1 - 220 Ω @ R3
- _____ 1 - 680 Ω @ R8
- _____ 1 - 1.2 KΩ @ R4
- _____ 1 - 2.2 KΩ @ R1
- _____ 2 - 4.7 KΩ @ R7,10
- _____ 2 - 10 KΩ 10-pin SIP* bussed @ R9,13
*Match pin 1 of SIP with pin 1 (arrow) on the layout

CAPACITORS C

- _____ 1 - 50 pF @ C4
- _____ 3 - 200 pF @ C6,8,14
- _____ 9 - 0.1 μF Monolithic @ C1,2,3,5,6, @ C7,9,10,11,13
- _____ 1 - 10 μF/16V Tantalum* @ C12
*Match + of Tantalum with + on the layout

SOCKETS *Match pin 1 of sockets with pin 1 on the layout. Check that ALL pins have passed thru ALL holes

- _____ 8 - 14-pin
- _____ 7 - 16-pin
- _____ 1 - 20-pin
- _____ 1 - 40-pin

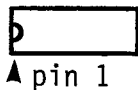

TRANSISTORS Q *Position EBC leads as shown

- _____ 1 - 2N3904 @ Q1



LIGHT EMITTING DIODE LED

- _____ 1 - LED @ CARD ON *Position longer lead (+) with + on the layout

SWITCH

- _____ 1 - 4-position DIP @ S1
- Functions: 1-address offset when off
2-Z80 DMA when off
3-non-mask int when off
4-Z-80 interrupts when off

INTEGRATED CIRCUITS *Match pin 1 of ICs

- _____ with pin 1 on the layout
- _____ 1 - 74LS00 @ U1
- _____ 1 - 74LS05 @ U2
- _____ 1 - 74LS32 @ U3
- _____ 1 - 74LS20 @ U12
- _____ 2 - 74LS74 @ U5,6
- _____ 1 - 74LS86 @ U7
- _____ 1 - 74LS107 @ U4
- _____ 1 - 74LS138 @ U11
- _____ 1 - 74LS283 @ U8
- _____ 5 - 74LS367 @ U9,13,14,16,17
- _____ 1 - 74LS373 @ U15
- _____ 1 - Z80A @ U10



GUIDE 4-8

EXCEL Z80 CARD: Allows one to use the CP/M operating system with the Z80 microprocessor installed. With power off, install in slot 4.

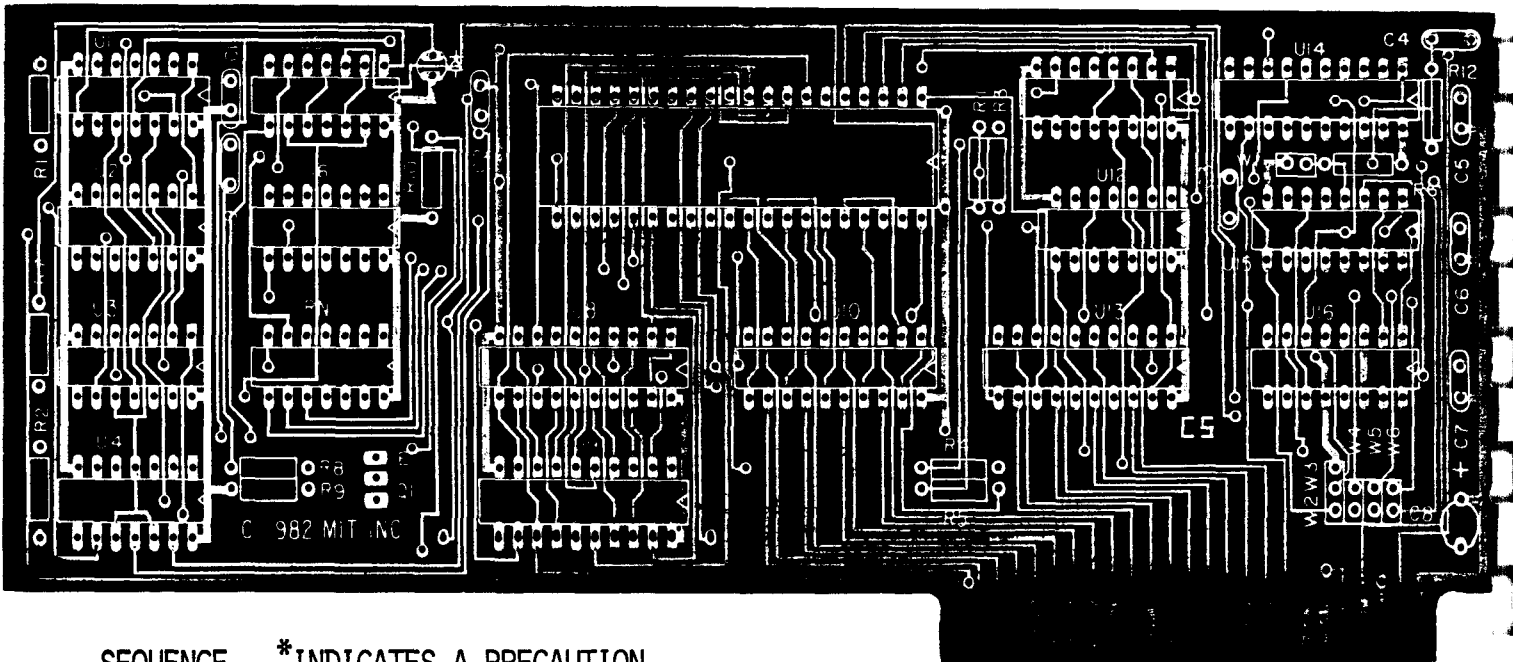

SEQUENCE *INDICATES A PRECAUTION
MODIFICATION REQUIRED ON THE SOLDER SIDE

RESISTORS R 1/2 watt, 5%

- 1 - 30 Ω @ R9
- 4 - 100 Ω @ R4,5,11,12
- 1 - 220 Ω @ R8
- 1 - 560 Ω @ R7
- 1 - 1.2 KΩ @ R1
- 1 - 1.5 KΩ @ R10
- 3 - 2 KΩ @ R2,3,6
- 1 - 10 KΩ 14-pin DIP @ RN

SOCKETS *Match pin 1 of sockets with pin 1 on the layout. Check that ALL pins have passed thru ALL holes

- 8 - 14-pin
- 3 - 16-pin
- 5 - 20-pin
- 1 - 40-pin

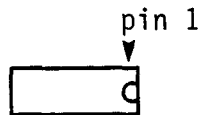

CAPACITORS C

- 1 - 22 pF @ C3
- 1 - 47 pF @ C9
- 1 - 100 pF @ C4
- 5 - 0.1 μF Monolithic @ C1,2,5,6,7
- 1 - 10 μF/16V Tantalum* @ C8

*Match + of Tantalum with + on the layout

TRANSISTOR Q *Match ebc transistor leads with ebc on the layout

- 1 - 2N3906 @ Q1

LIGHT EMITTING DIODE LED *Position cathode of diode toward the arrow

- 1 - LED @

HEADERS male, straight

- 4 - 1x2 @ W1,W4,W5,W6
- 1 - 1x3 @ W2W3

INTEGRATED CIRCUITS *Match pin 1 of ICs with pin 1 on the layout

- 1 - 74LS04 @ U1
- 2 - 74LS05 @ U5,15
- 1 - 74LS08 @ U6
- 1 - 74LS10 @ U12
- 1 - 74LS32 @ U2
- 2 - 74LS74 @ U3,14
- 1 - 74LS112 @ U11
- 4 - 74LS244 @ U8,10,13,14
- 1 - 74LS283 @ U16
- 1 - 74LS373 @ U9
- 1 - Z80 MPU @ U7

NuScope
Associates

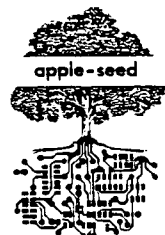

EXCEL Z80 CARD: (continued)

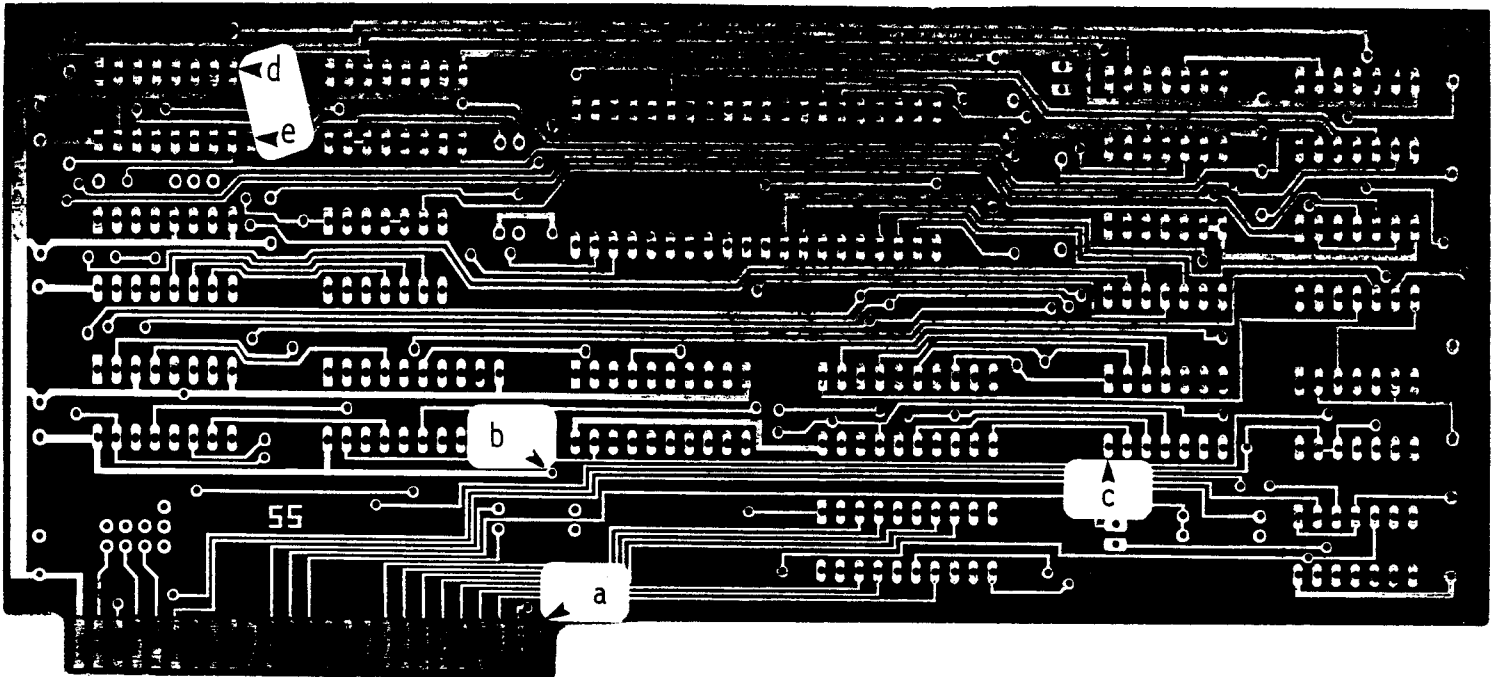

MODIFICATIONS ON THE SOLDER SIDE Refer to the preceding layout

- 1 - Install one 0.1 μ F Monolithic capacitor between "a" pin 50 (+12V) of card edge connector to "b" plate-thru hole.
- 2 - Strap "b" plate-thru hole to "c" pin 14 of RN.
- 3 - Strap "d" pin 8 of U14 to "e" pin 12 of U14.

MODIFICATION ON THE COMPONENT SIDE

- 1 - Bend out pin 12 - NOT USED - of U14.

GUIDE 5-1

PARALLEL PRINTER CARD: Centronics compatible parallel interface featuring advanced text features and HIRES dot graphics. Requires firmware (one EPROM). With power off, install in slot number 1.

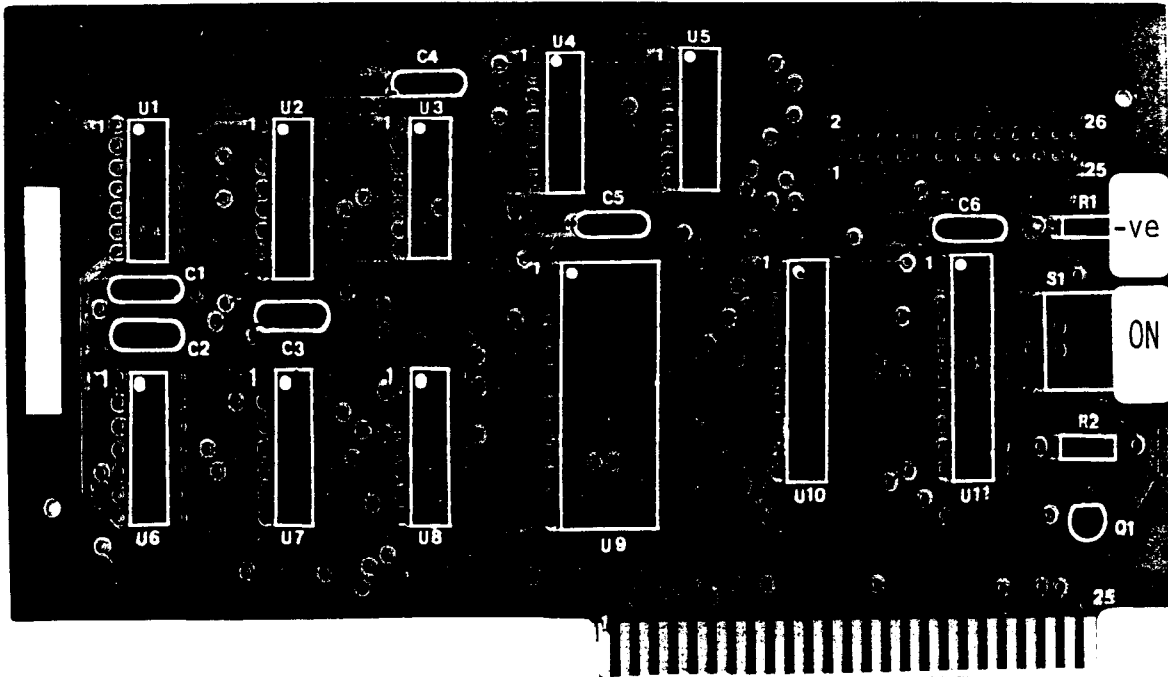

SEQUENCE * INDICATES A PRECAUTION

DIODE D *Position banded end (cathode, -ve) of diode as shown on the layout
 ___ 1 - 1N4001 @ R1 *Error on layout

RESISTORS R ¼ watt, 5%
 ___ 1 - 4.7 KΩ @ R2

SOCKETS *Match pin 1 of sockets with pin 1 (white dot) on the layout. Check that ALL pins have passed thru ALL holes

- ___ 7 - 14-pin
- ___ 1 - 16-pin
- ___ 2 - 20-pin
- ___ 1 - 24-pin

CAPACITORS C
 ___ 1 - 100 pF disc ceramic @ C1
 ___ 1 - 470 pF disc ceramic @ C3
 ___ 4 - 0.1 μF Monolithic @ C2,4,5,6

TRANSISTOR Q *Match the EBC transistor leads as shown
 ___ 1 - 2N3904



CONNECTOR

___ 1 - 2x13 male header strip, right angle

SWITCH

___ 1 - 4-position DIP @ S1

INTEGRATED CIRCUITS *Match pin 1 of ICs with pin 1 on the layout

- ___ 3 - 74LS00 @ U1,4,6 pin 1 > 1
- ___ 1 - 74LS02 @ U3 upper left for
- ___ 1 - 74LS08 @ U7 ALL sockets
- ___ 1 - 74LS30 @ U8 & ICs
- ___ 1 - 74LS74 @ U5
- ___ 1 - 74LS279 @ U2
- ___ 2 - 74LS373 @ U10,11
- ___ 1 - 2732 EPROM @ U9



GUIDE 5-2

PRINTER BUFFER CARD: Adds memory - 16K, 32K, or 64K RAM - to your current parallel printer interface. With power off, connect by means of an appropriate cable, to your existing printer card: install in slot adjacent to printer card. Requires firmware (one EPROM).

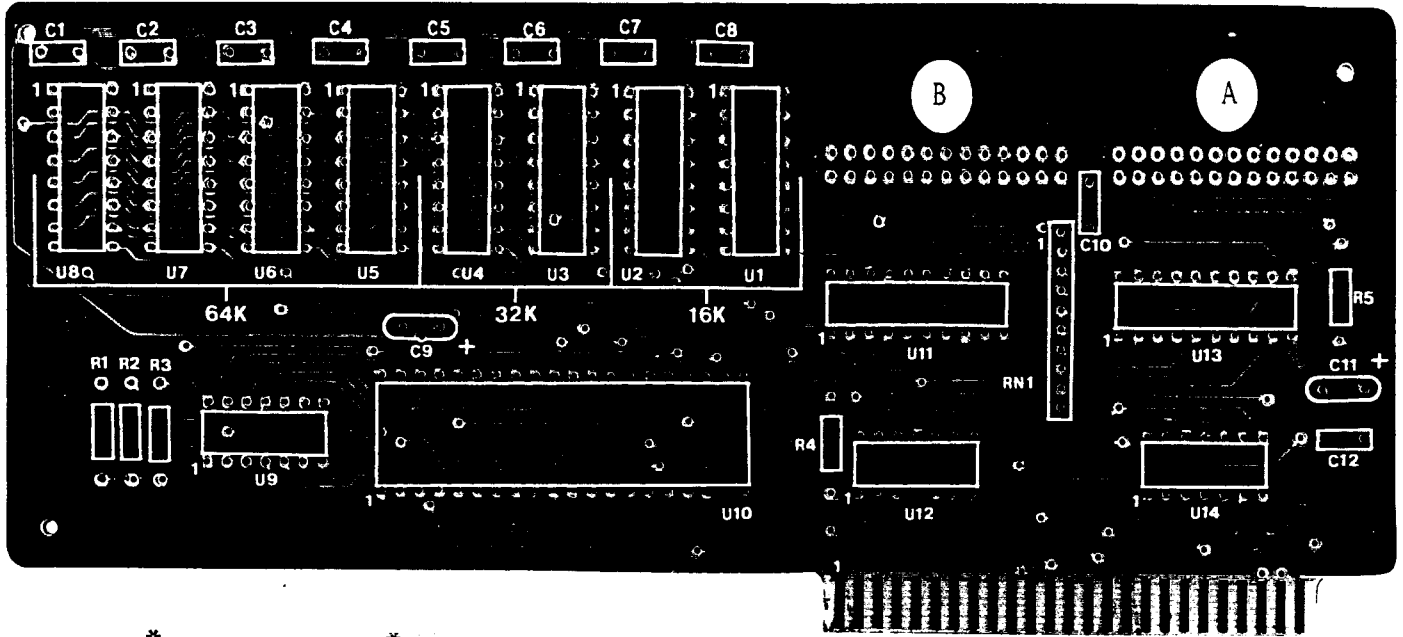

SEQUENCE *A PRECAUTION *DO MODIFICATIONS FIRST

RESISTORS R ¼ watt, 5%

- _____ 5 - 4.6 KΩ @ R1,2,3,4,5
- _____ 1 - 4.7 KΩ 9-pin SIP @ RN 1*

*Match pin 1 (common) of SIP with pin 1 of RN 1 on the layout

SOCKETS *Match pin 1 of sockets with pin 1

on the layout. Check that ALL pins have passed thru ALL holes

- _____ 3 - 14-pin
- _____ 8 - 16-pin
- _____ 2 - 20-pin
- _____ 1 - 40-pin



▲ pin 1 for ALL sockets & ICs

CAPACITORS C

- _____ 10 - 0.1 μF Monolithic @ C1,2,3,4,5,6, C7,8,10,12
- _____ 1 - 2.2 μF/25v Radial* @ C9
- _____ 1 - 100 μF/16v Radial* @ C11

*Match + of capacitors with + on layout

MODIFICATIONS *On the COMPONENT SIDE

- _____ 7 - Cuts: Cut the trace from pin 14 to pin 14 of: U1-2; U2-3; U3-4; U4-5; U5-6; U6-7; U7-8

CONNECTORS

- _____ 2 - 2x13 male header strip, right-angle

INTEGRATED CIRCUITS *Match pin 1 of IC with pin 1 on the layout

- _____ 1 - 74LS32 @ U14
- _____ 1 - 74LS74 @ U12
- _____ 2 - 74LS374 @ U11,13
- _____ 1 - 74LS38 @ U9
- _____ 1 - D8748 8-bit CPU, 4K EPROM (8048) @ U10
- _____ 8 - 4564 RAM @ U1,2 for 16K RAM @ U1 to 4 for 32K RAM @ U1 to 8 for 64K RAM

RIBBON CABLE CONNECTOR

- _____ 1 - 10-12 cm length, 26-conductor, with connectors @ each end to connect buffer-board from A on the layout to printer interface card. Use existing printer cable to connect bufferboard from B on the layout to the printer



GUIDE 5-3

PARALLEL PRINTER INTERFACE CARD: Allows one to produce printed output (hardcopy) on a variety of printers; may also be used as a general purpose output card to drive music synthesizers, analog-to-digital converters, etc. With power off, install in slot number 1. Requires firmware (one PROM).

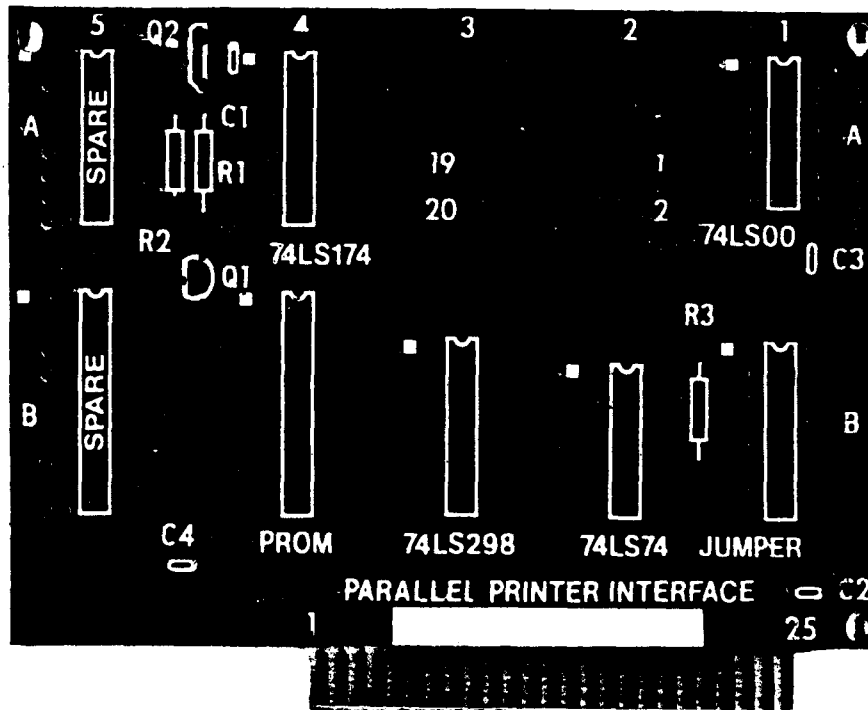

SEQUENCE *INDICATES A PRECAUTION

RESISTORS R ¼ watt, 5%

- 1 - 150 Ω @ R1
- 1 - 68 Ω @ R2
- 1 - 12 KΩ @ R3

CAPACITORS C

- 4 - 0.1 μF @ C1,2,3,4

SOCKETS *Match pin 1 of sockets with pin 1 on the layout. Check that ALL pins of sockets have passed thru ALL holes

- 2 - 14-pin
- 3 - 16-pin
- 1 - 20-pin

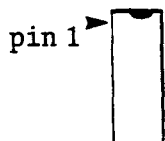

TRANSISTORS Q *Install EBC leads as shown

- 1 - 2N3904 @ Q1
- 1 - MPSU51 @ Q2

*Check with supplier re EBC leads of transistors

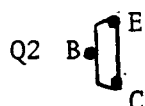
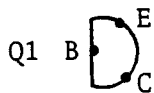

INTEGRATED CIRCUITS *Match pin 1 of IC with pin 1 on layout

- 1 - 74LS00
- 1 - 74LS74
- 1 - 74LS174
- 1 - 74LS298
- 1 - 6309 PROM

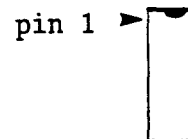

CONNECTOR

- 1 - 2x10 male header strip, right-angle
*Position pins UP
- 1 - ribbon cable with appropriate connectors

JUMPER

- 1 - 16-pin DIP header
- 1 - jumper block

NOTE: The pin-out of the ribbon cable and the wiring of the jumper block must be customized for your specific printer. Refer to the appropriate printer interface card installation manual

GUIDE 5-4

EPSON/CENTRONICS INTERFACE CARD: Allows interface to parallel printers.
 With power off, install in slot number 1. Requires firmware (one EPROM).

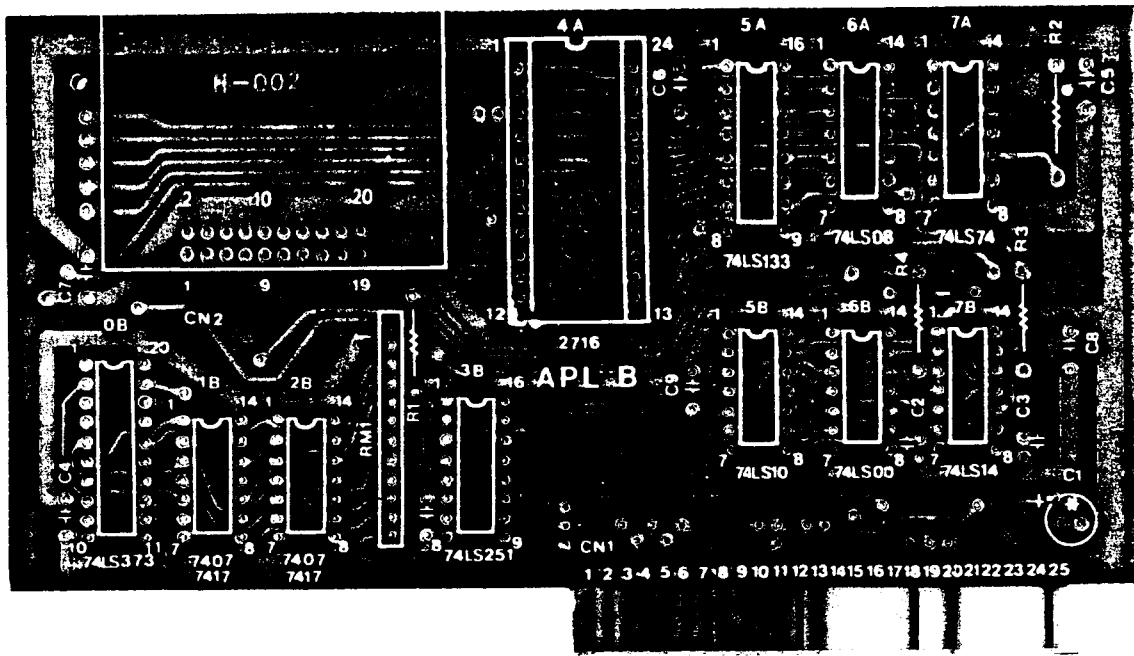

SEQUENCE

*INDICATES A PRECAUTION

RESISTORS R

1/4 watt, 5%

- 2 - 12 KΩ @ R1,2
- 2 - 100 Ω @ R3,4
- 1 - 1 KΩ 11-pin SIP @ RM1
- *Pin 1 of SIP is labelled "1" on the layout

CAPACITORS C

- 1 - 10 μF/16v Tantalum* @ C1
- *Match + of capacitor with + on the layout
- 2 - 0.001 μF @ C2,3
- 7 - 0.1 μF Monolithic @ C4 to C10
- *C10 is NOT labelled on the layout and is located between the SIP and the 74LS251 IC

SOCKETS

*Match pin 1 of sockets with pin 1 on the layout. Check that ALL pins have passed thru ALL holes

- 7 - 14-pin
- 2 - 16-pin
- 1 - 20-pin
- 1 - 24-pin

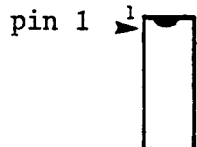

CONNECTOR

- 1 - 2x10 male header strip, right angle
- *Position pins UP

INTEGRATED CIRCUITS *Match pin 1 of IC with pin 1 on the layout

- 1 - 74LS00
- 2 - 74LS07
- 1 - 74LS08
- 1 - 74LS10
- 1 - 74LS14
- 1 - 74LS74
- 1 - 74LS133
- 1 - 74LS251
- 1 - 74LS373
- 1 - 2716 EPROM

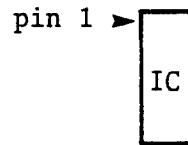

GUIDE 5-5

PRINT-ALL CARD: Parallel printer interface card for text and graphics applications. With power off, install in slot number 1 (recommended). Requires firmware (one EPROM).

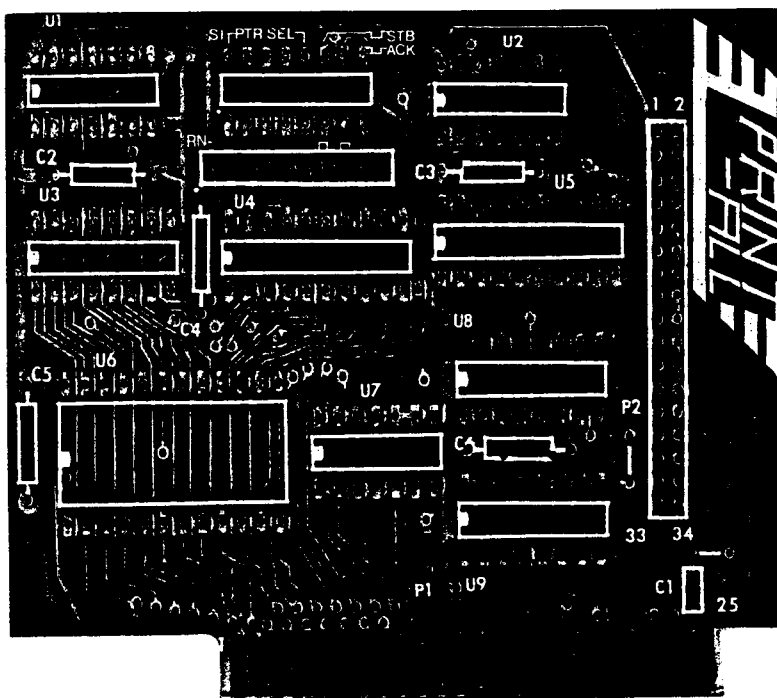

SUGGESTED SEQUENCE *INDICATES A PRECAUTION

RESISTORS: R ¼ watt, 5%

___ 1 - 2K-10 KΩ 10-pin SIP resistor @ RN

SOCKETS *Match pin 1 of sockets with pin 1 on the layout. Check that ALL pins have passed thru ALL holes

- ___ 3 - 14-pin
- ___ 3 - 16-pin
- ___ 2 - 20-pin
- ___ 1 - 24-pin

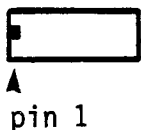

CAPACITORS C

___ 1 - 33 μF/16v Radial* @ C1
*Match + of capacitor as shown

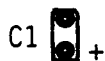

___ 5 - 0.1 μF Monolithic @ C2,3,4,5,6

SWITCH SW

___ 1 - 8-position DIP @ SW1
Set switches as per printer instructions

CONNECTOR

___ 1 - 2x17 header strip, straight @ P2

CABLE

___ 1 - as per printer

INTEGRATED CIRCUITS *Match pin 1 of IC with pin 1 on the layout

- ___ 1 - 74LS02 @ U1
- ___ 1 - 74LS08 @ U7
- ___ 1 - 74LS86 @ U2
- ___ 1 - 74LS133 @ U3
- ___ 1 - 74LS138 @ U9
- ___ 1 - 74LS244 @ U4 pin 1
- ___ 1 - 74LS273 @ U5
- ___ 1 - 74LS279 @ U8
- ___ 1 - 2732 EPROM @ U6

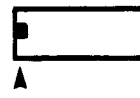

GUIDE 5-6

MICRO-2-BUFFER: Centronics-compatible parallel printer interface featuring up to 32 K bytes of data buffering and advanced HIRES dump routines. Allows computer to simultaneously print and process. Requires firmware (two EPROMs). With power off, install in any slot except 0 (slot # 1 recommended). Modifications required.

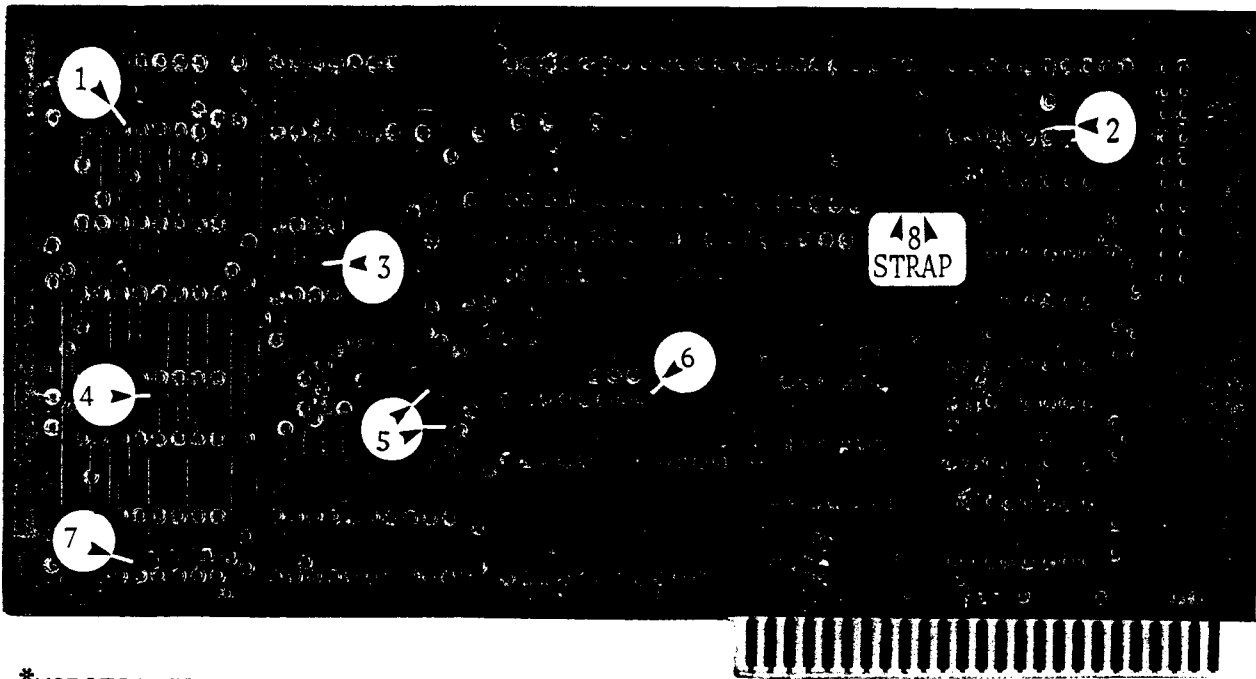

*MODIFICATIONS REQUIRED

ON THE COMPONENT SIDE. The following numbers refer to the numbers on the layout

- 1 cut trace directly above pin 2 of U1
- 2 cut trace between pin 7 of U4 & the feed-thru hole located directly above
- 3 cut trace directly above pin 4 of U6
- 4 cut trace connecting pin 4 of U10 to pin 13 of U10
- 5 isolate the -ve solder pad of C6 by making two cuts on either side
- 6 cut trace directly above pin 9 of U8

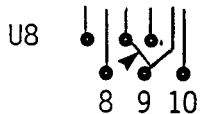

- 7 cut trace directly above pin 3 of U12
- 8 strap two feed-thru holes as shown

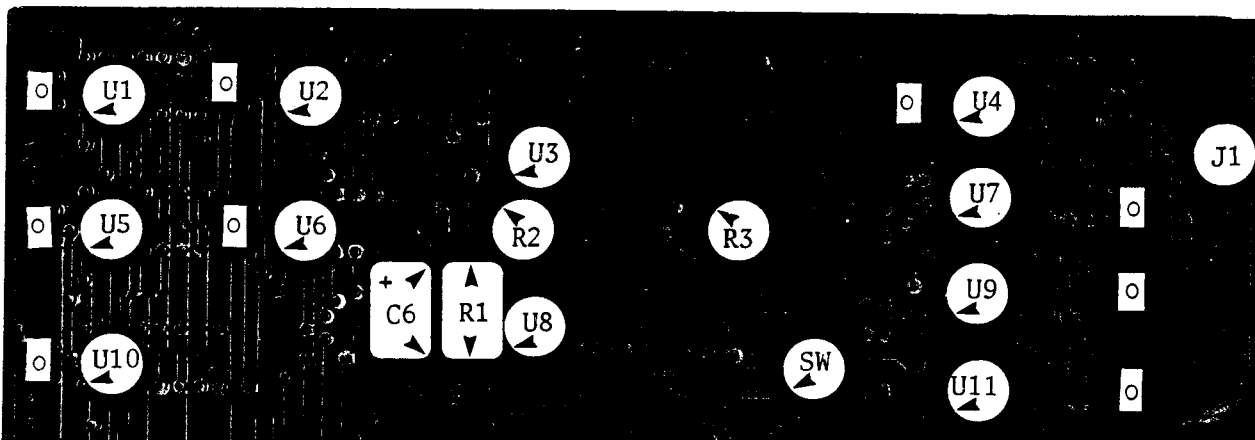

MICRO-2-BUFFER (continued)

SEQUENCE *INDICATES A PRECAUTION

RESISTORS $\frac{1}{2}$ watt, 5%

- _____ 1 - 470 Ω @ R1
- _____ 2 - 10 K Ω 10-pin SIP* bussed @ R2,3
*Match pin 1 of SIPs with pin 1
(arrow) on the layout

SOCKETS Match pin 1 of sockets with pin
1 (arrow) on the layout. Check that
ALL pins have passed thru ALL holes

- _____ 4 - 14-pin @ U1,2,6,15
- _____ 7 - 16-pin @ U5,7,9,10, 11,12,16
- _____ 2 - 20-pin @ U4,13
- _____ 2 - 24-pin @ U8,14
- _____ 1 - 40-pin @ U3

CAPACITORS C

- _____ 13 - 0.1 F Monolithic @ o
- _____ 1 - 22 F/50V Axial* @ C6
*Match + of Axial
with + on the layout

HEADER

- _____ 1 - 2x10 male, straight, @ J1

SWITCH -

- _____ 1 - 6-position DIP @ SW

INTEGRATED CIRCUITS *Match pin 1 of ICs
with pin 1 on the layout

- _____ 1 - 74LS00 @ U1
- _____ 1 - 74LS30 @ U15
- _____ 1 - 74LS74 @ U2
- _____ 1 - 74LS132 @ U6
- _____ 1 - 74LS139 @ U12
- _____ 1 - 74LS279 @ U5
- _____ 1 - 74LS368 @ U10
- _____ 2 - 74LS374 @ U4,13
- _____ 1 - 1802 @ U3
- _____ 4 - 4164 64Kx1 dynamic RAM
@ U7,9,11,16
- _____ 2 - 2716 EPROM @ U8,14

SWITCH SETTINGS

SWITCH	OFF	ON
1	40 column default/video on	80 column default/ video off
2	keyboard reset has no effect	keyboard reset clears buffer
3,4	not used	not used
5	32 K buffer	16 K buffer
6	buffer enabled	buffer disabled

GUIDE 5-7

PRELUDE 32 K PRINTER/BUFFERED CARD: Centronics-compatible parallel printer interface with 32 K bytes of data buffering, and advanced HIRES dump routines. Allows computer to simultaneously print and process. Requires firmware (two EPROMs). With power off, install in any slot except 0 (slot 1 recommended. Modifications required on the solder side .

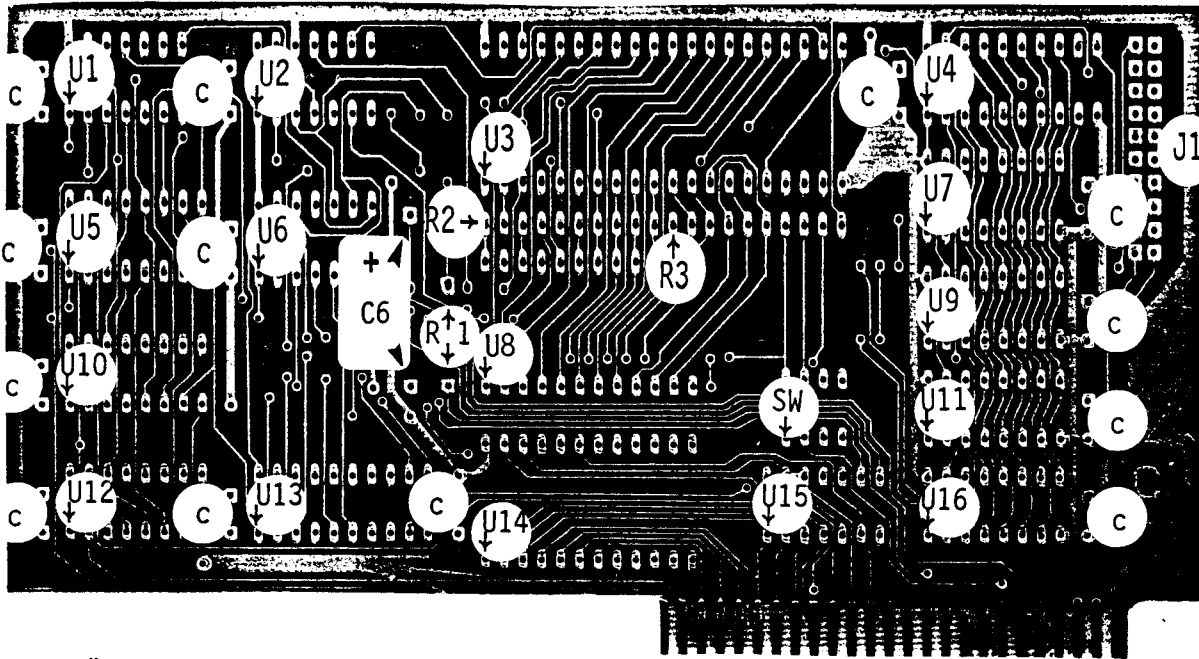

SEQUENCE *INDICATES A PRECAUTION

RESISTORS R ¼ watt, 5%

- _____ 1 - 470 Ω @ R1
- _____ 2 - 10 KΩ 10-pin SIP* bussed @ R2,3
- _____ *Match pin 1 of SIPs with pin 1 (arrow) on the layout

SOCKETS *Match pin 1 of sockets with pin 1 (arrow) on the layout. Check that ALL pins have passed thru ALL holes

- _____ 4 - 14-pin @ U1,2,6,15
- _____ 7 - 16-pin @ U5,7,9,10,11,12,16
- _____ 2 - 20-pin @ U4,13
- _____ 2 - 24-pin @ U8,14
- _____ 1 - 40-pin @ U3

CAPACITORS C

- _____ 13 - 0.1 μF Monolithic @ c
- _____ 1 - 22 μF/50V Axial* @ C6
- _____ *Match + of axial with + on the layout

HEADER

- _____ 1 - 2x10 male, straight @ J1

SWITCH

- _____ 1 - 4-position DIP @ SW
- _____ *Arrow indicates switch 1

SWITCH SETTINGS

SWITCH

OFF

ON

- | | | |
|---|------------------------------|------------------------------|
| 1 | 40-column default/video on | 80-column default/video off |
| 2 | keyboard reset has no effect | keyboard reset clears buffer |

INTEGRATED CIRCUITS *Match pin 1 of ICs with pin 1 on the layout

- _____ 1 - 74LS00 @ U1
- _____ 1 - 74LS30 @ U15
- _____ 1 - 74LS74 @ U2
- _____ 1 - 74LS132 @ U6
- _____ 1 - 74LS139 @ U12
- _____ 1 - 74LS279 @ U5
- _____ 1 - 74LS368 @ U10
- _____ 2 - 74LS374 @ U4,13
- _____ 1 - 1802 @ U3
- _____ 4 - 4164 RAM @ U7,9,11,16
- _____ 2 - 2716 EPROM @ U8,14



PRELUDE 32 K PRINTER/BUFFERED CARD (continued)

*MODIFICATION REQUIRED ON THE SOLDER SIDE as shown on the layout below

Make two cuts

Strap A to A and B to B

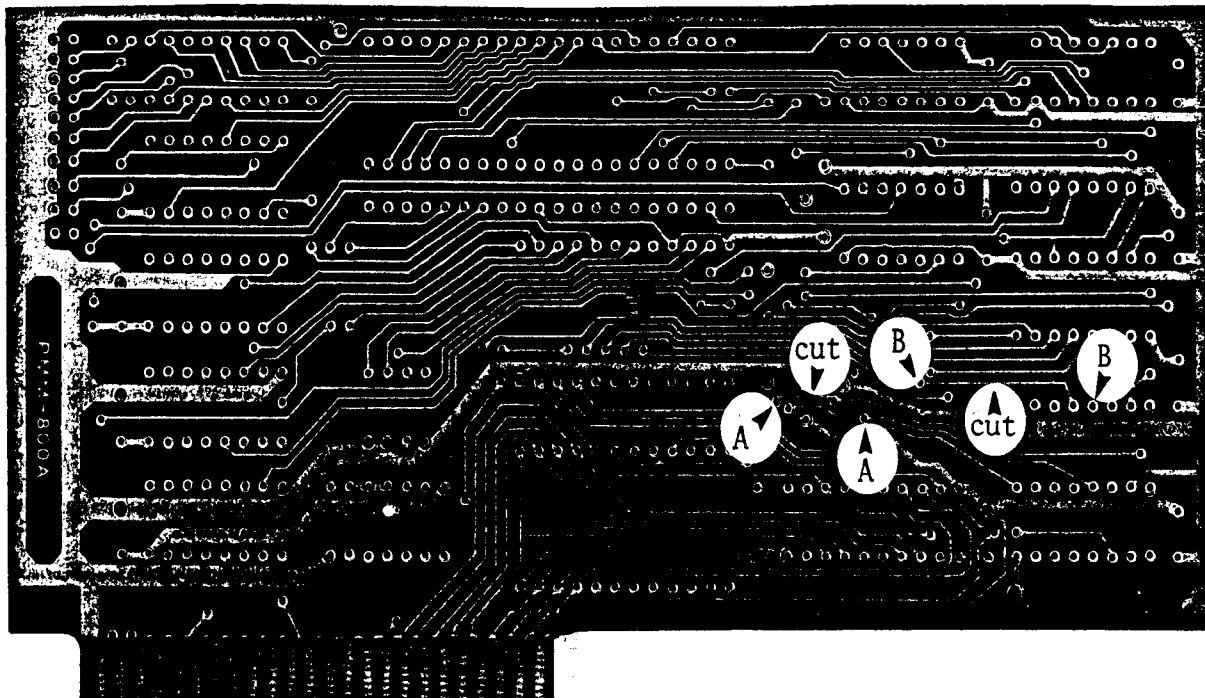

PRINTER BUFFER: Centronics-compatible parallel printer interface with up to 64 K RAM of buffered memory. With power off, install in slot 1. Requires firmware (one EPROM).

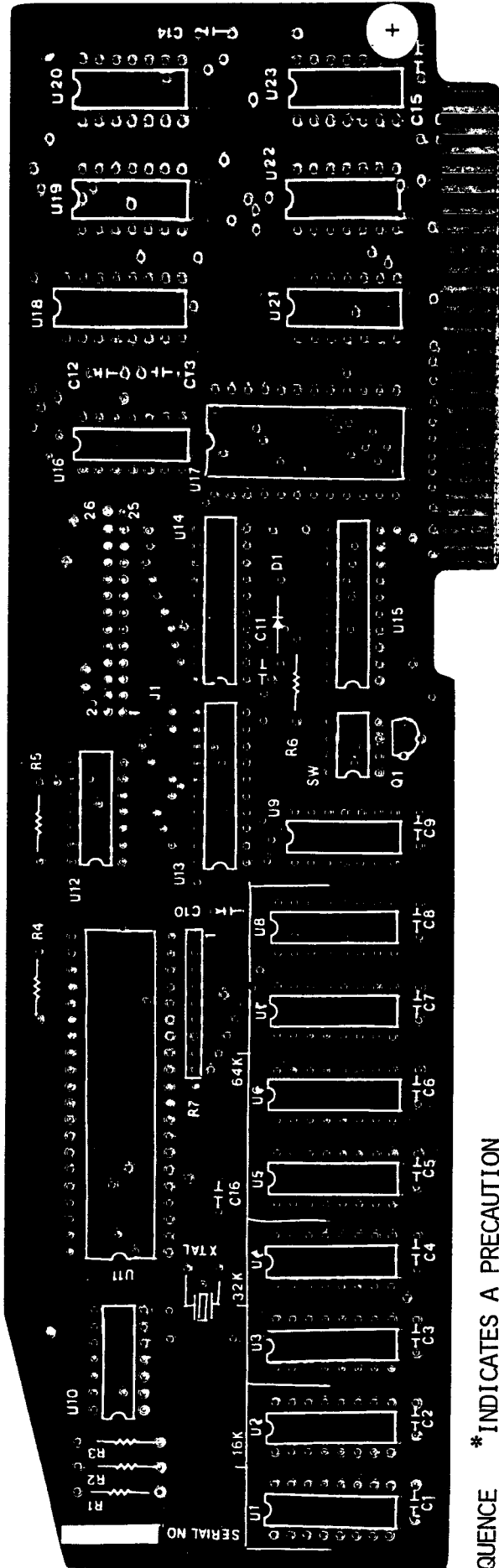

SEQUENCE *INDICATES A PRECAUTION

DIODE *Position banded end of diode towards the arrow
 1 - 1N4148 @ D1

RESISTORS R 1/4 watt, 5%
 6 - 4.7 K Ω @ R1,2,3,4,5,6
 1 - 10 K Ω 9-pin SIP bussed @ R7
 *Match pin 1 of SIP with pin 1 on the layout

SOCKETS *Match pin 1 of sockets with pin 1 on the layout. Check that ALL pins have passed thru ALL holes
 9 - 14-pin
 9 - 16-pin
 3 - 20-pin
 1 - 24-pin
 1 - 40-pin

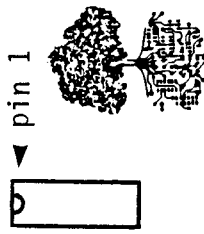

CAPACITORS C
 1 - 47 pF
 1 - 100 pF
 12 - 0.1 μ F Monolithic @ C1 to C11 & @ C14
 1 - 2.2 μ F/16V Tantalum* @ C15
 1 - 10 μ F/16V Tantalum* @ C16
 *Match + of Tantalums with + on the layout

TRANSISTOR Q Match ebc leads as shown on the layout
 1 - 2N3904 @ Q1
 SWITCH
 1 - 4-position DIP @ SW
 CRYSTAL Y *Not required

CONNECTOR

1 - 2x13 header, male, straight @ J1

INTEGRATED CIRCUITS *Match pin 1 of ICs with pin 1 on the layout

- 3 - 74LS00 @ U16,19,23
- 1 - 74LS02 @ U20
- 1 - 74LS08 @ U22
- 1 - 74LS30 @ U21
- 1 - 74LS32 @ U9
- 1 - 74LS38 @ U10
- 1 - 74LS74 @ U12
- 1 - 74LS279 @ U18
- 1 - 74LS373 @ U15
- 2 - 74LS374 @ U13,14
- 1 - D8748 CPU-EPROM @ U11
- 1 - 2732 EPROM @ U17
- 8 - 4164 RAM @ U1 to U8

GUIDE 5-9

COLLEGE NICE PRINT CARD: Precision printer card that supports Epson & Gemini dot-matrix printers to produce normal & near-letter quality print. Has a) optional font styles (may be italicized); six pitches 5 to 17 in Pica, Elite, Condensed; and underline, boldface, subscript & superscript. With power off, install in slot 1. Documentaion available from supplier. Requires firmware (one EPROM).

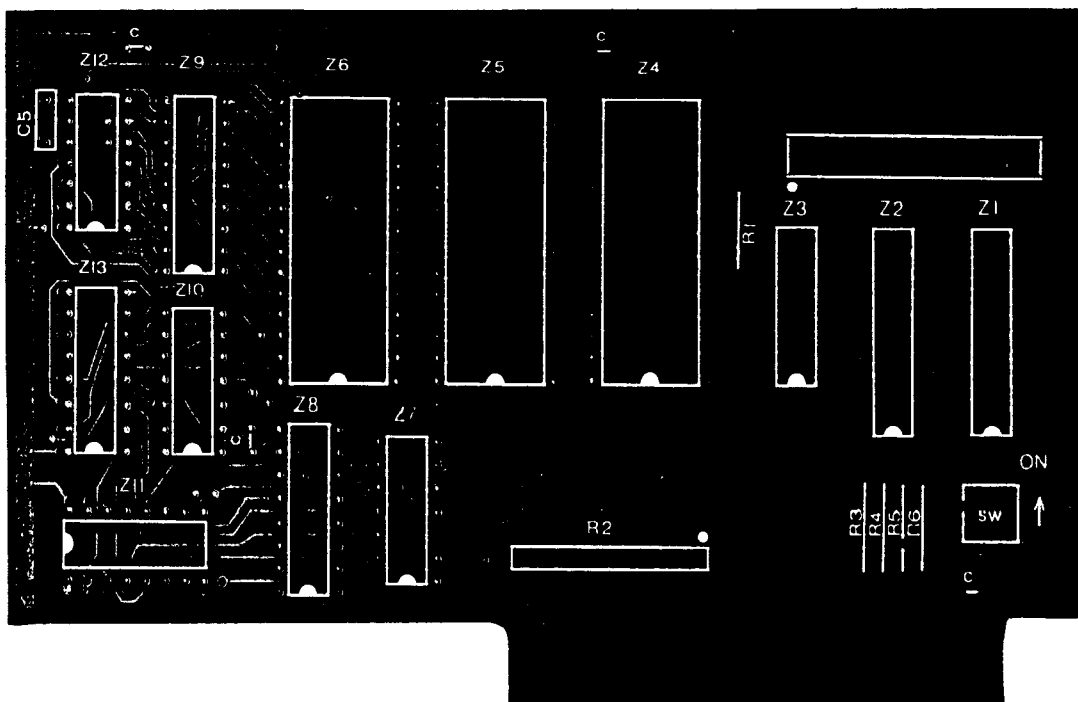

SEQUENCE *INDICATES A PRECAUTION

RESISTORS R ½ watt, 5%

- _____ 5 - 3.3 KΩ @ R1,3,4,5,6
- _____ 1 - 2.2 KΩ 10-pin SIP* bussed @ R2
- _____ *Match pin 1 of SIP with pin 1 (white dot) on the layout

SOCKETS *Match pin 1 of sockets with pin 1 on the layout. Check that ALL pins have passed thru ALL holes

- _____ 3 - 14-pin
- _____ 4 - 16-pin
- _____ 1 - 18-pin
- _____ 2 - 20-pin
- _____ 3 - 28-pin

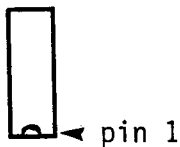

CAPACITORS C

- _____ 1 - 15 pF @ C5
- _____ 4 - 0.1 μF Monolithic @ C

SWITCH & SWITCH SETTINGS

- _____ 1 - 4-position DIP @ SW

EPSON: 1,2,3,4 on
GEMINI: 1,2,4 on; 3 off

CONNECTORS

- _____ 1 - 2x3 header, male, straight
- _____ 1 - appropriate printer cable

INTEGRATED CIRCUITS *Match pin 1 of ICs with pin 1 on the layout

- _____ 1 - 74LS00 @ Z7
- _____ 1 - 74LS02 @ Z10
- _____ 1 - 74LS30 @ Z12
- _____ 2 - 74LS138 @ Z8,13
- _____ 1 - 74LS174 @ Z11
- _____ 1 - 74LS279 @ Z3
- _____ 2 - 74LS374 @ Z1,2
- _____ 1 - 2114 @ Z9
- _____ 1 - 2764 EPROM @ Z4
- _____ 2 - 2764 EPROM @ Z5,6 (optional)

NuScope
Associates

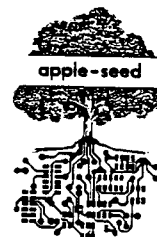

GUIDE 6-1

COMMUNICATIONS INTERFACE CARD: Bi-directional communication between the computer and external electronic devices such as printers, terminals, modems, other computers, etc. With power off, install in slot 1. Requires firmware (one EPROM).

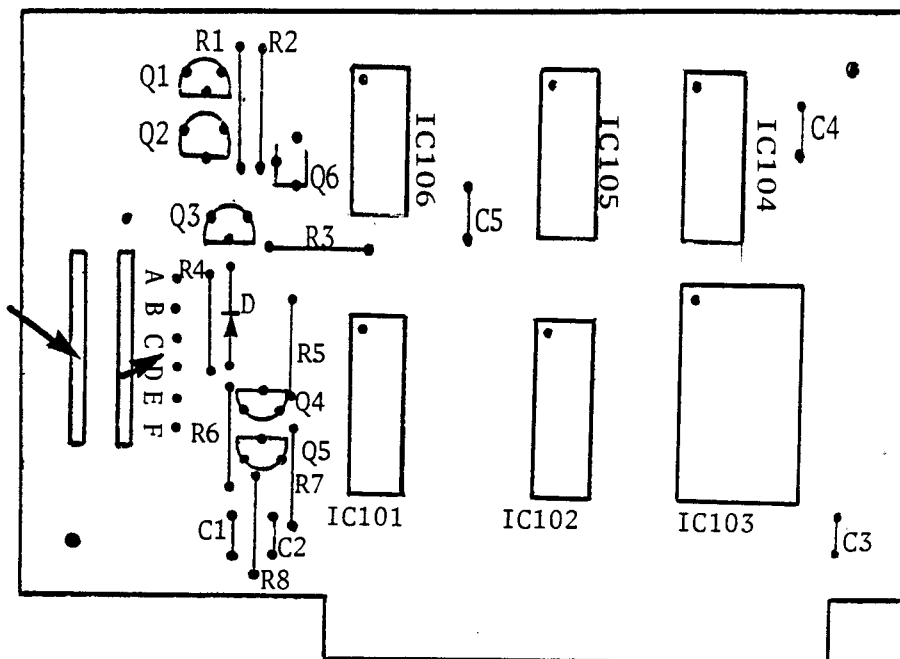

SEQUENCE *INDICATES A PRECAUTION

RESISTORS R 1/4 watt, 5%

- 2 - 150 Ω @ R1,6
- 1 - 68 Ω @ R2
- 4 - 3.3 KΩ @ R3,4,5,8
- 1 - 10 KΩ @ R7

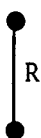

TRANSISTORS Q *Position EBC leads as shown

- 3 - 2N3906 @ Q1,2,4
- 2 - 2N3904 @ Q3,5
- 1 - 2N4355 @ Q6

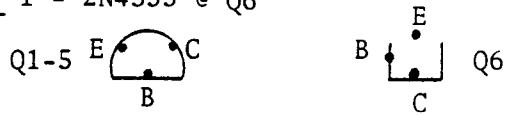

DIODE D *Position banded end (cathode) of diode as shown

- 1 - 1N4148
- cathode end
 banded end

RIBBON CABLE: 6-wire with DB-25 connector
Connect as follows:

PC Board	DB-25
A	1
B	2
C	3
D	4
E	7
F	8

CAPACITORS C at

- 5 - 0.1 μF Monolithic @ C1,2,3,4,5



SOCKETS *Match pin 1 of sockets with pin 1 on the layout. Check that ALL pins have passed thru ALL holes.

- 2 - 10-pin
 - 1 - 14-pin
 - 2 - 16-pin
 - 1 - 24-pin
- pin 1 →
 upper left for
 ALL sockets
 & ICs

- INTEGRATED CIRCUITS IC *Match pin 1 of ICs with pin 1 on the layout
- 1 - 6309 PROM @ 101
 - 1 - 74LS245 @ 102
 - 1 - 6850 @ 103
 - 2 - 74LS161 @ 104,105
 - 1 - 74LS74 @ 106



GUIDE 6-2

SERIAL CARD: Allows serial communication (RS-232) to peripheral devices such as printer, modem. With power off, install in slot number 2. Requires firmware (two PROMS).

Secure ribbon cable in this manner:

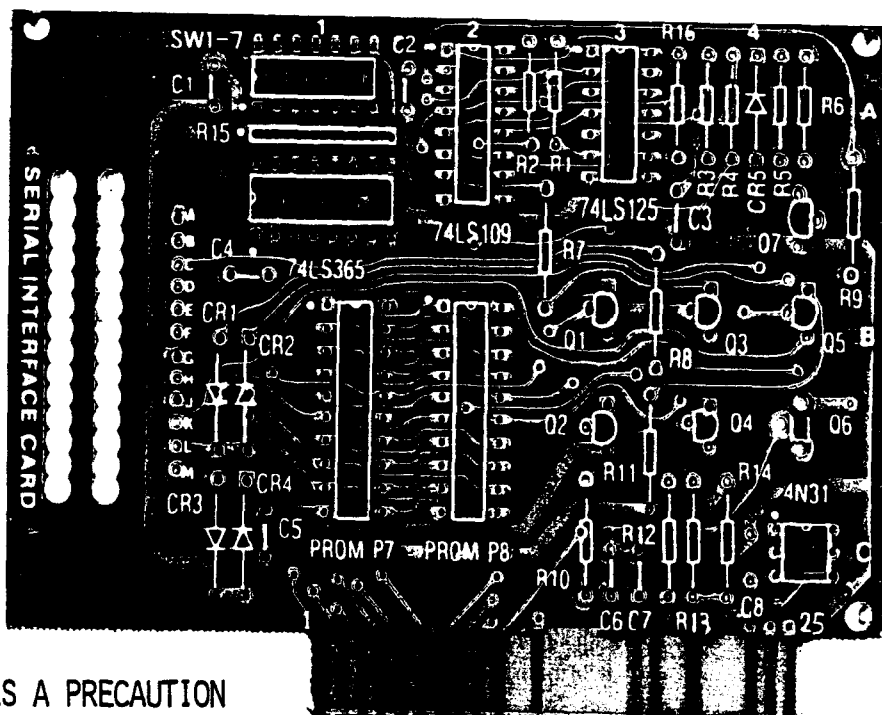
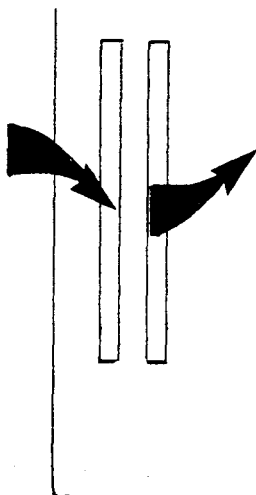

SEQUENCE

*INDICATES A PRECAUTION

DIODES D *Position banded end (cathode) of diode as shown

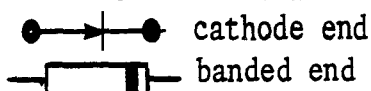

5 - 1N4448 @ CR1,2,3,4,5

RESISTORS R 1/4 watt, 5%

- 2 - 1 KΩ @ R1,16
- 6 - 3 KΩ @ R2,4,5,7,9,12
- 1 - 68 Ω @ R3
- 1 - 12 KΩ @ R6
- 2 - 390 Ω @ R8,14
- 1 - 150 Ω @ R10
- 1 - 100 Ω @ R11
- 1 - 2.2 KΩ 8-pin SIP @ R15
- 1 - 2 KΩ @ R13

*Pin 1 is indicated by a dot (•) on the layout

CAPACITORS C

8 - 0.1 μF Monolithic @ C1,2,3,4,5,6,7,8

SOCKETS *Match pin 1 of sockets with pin 1 (white dot) on the layout. Check that ALL pins have passed thru ALL holes

- 1 - 6-pin
- 1 - 14-pin
- 2 - 16-pin
- 2 - 20-pin

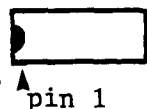

TRANSISTORS Q *Install 3 leads as shown

- 4 - 2N3906 @ Q1,2,3,5
- 2 - 2N3904 @ Q4,7
- 1 - MPSU51 @ Q6

*Check with supplier re EBC leads of transistor

SWITCH

1 - 7-position DIP switch

RIBBON CABLE 12-wire with DB-25 connector
Connect as follows

PC BOARD	DB-25	PC BOARD	DB-25
A	1	G	7
B	2	H	20
C	3	J	8
D	4	K	23
E	5	L	12
F	6	M	13

INTEGRATED CIRCUITS *Match pin 1 of IC with pin 1 (white dot) on the layout

- 1 - 74LS109
- 1 - 74LS125
- 1 - 74LS365
- 1 - 4N31
- 1 - 6309 PROM @ P7
- 1 - 6349 PROM @ P8

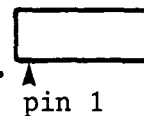

ASYNCHRONOUS SERIAL INTERFACE CARD: Allows user to interface the computer to peripheral devices including line printers, paper tape units, video terminals, as well as other computers. With power off, install in any slot except 0 (slot 2 recommended). Requires firmware (two PROMS).

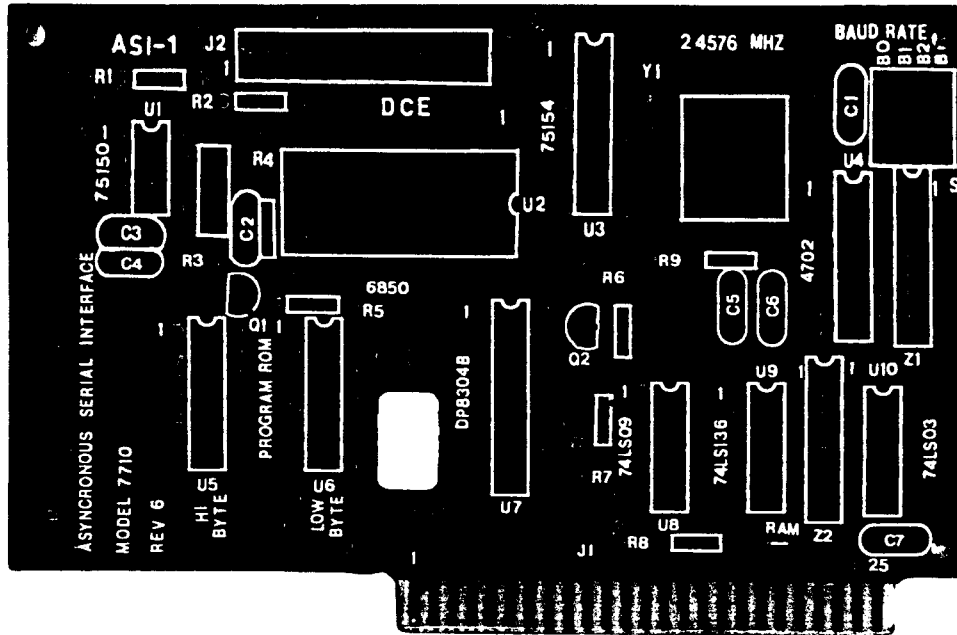

SEQUENCE *INDICATES A PRECAUTION

RESISTORS R 1/4 watt, 5% (except R3)

- _____ 1 - 10 Ω @ R1
- _____ 4 - 220 Ω @ R4,5,6,7
- _____ 1 - 680 Ω @ R2
- _____ 1 - 2.7 KΩ @ R8
- _____ 1 - 1 MΩ @ R9
- _____ 2 - 2.7 KΩ 8-pin SIP @ Z1,2 *Match pin 1 of SIPs with pin 1 on the layout
- _____ 1 - 100 Ω 1/2 watt, 5% @ R3

SOCKETS *Match pin 1 of sockets with pin 1 on the layout. Check that ALL pins have passed thru ALL holes

- _____ 1 - 8-pin
- _____ 3 - 14-pin
- _____ 4 - 16-pin
- _____ 1 - 20-pin
- _____ 1 - 24-pin

CAPACITORS C

- _____ 2 - 56 pF, 500VDC, Mica @ C5,6
- _____ 5 - 0.1 μF Monolithic @ C1,2,3,4,7

SWITCH

- _____ 1 - 4-position, DIP @ S1

CONNECTOR

- _____ 1 - 2x13 male header strip, straight @ J2

TRANSISTOR Q *Position the EBC leads as shown

- _____ 2 - 2N2907 @ Q1,2



CRYSTAL Y

- _____ 1 - 2.4576 MHz @ Y1
- *Fold body of crystal flat against the card before soldering. Insulate

INTEGRATED CIRCUITS *Match pin 1 of ICs with pin 1 on the layout

- _____ 1 - 75150 @ U1
- _____ 1 - 6850 @ U2
- _____ 1 - 75154 @ U3
- _____ 1 - 4702 (Fairchild) @ U4
- _____ 1 - 8304B @ U7
- _____ 1 - 74LS09 @ U8
- _____ 1 - 74LS136 @ U9
- _____ 1 - 74LS03 @ U10
- _____ 2 - 82S129 PROMs @ U5,6

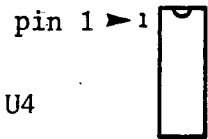

CABLE

- _____ 1 - 26-conductor ribbon cable, 20 cm long, with DB25S connector at one end and a 26-pin female header at the other end



GUIDE 6-4

SUPRA-SERIAL: Allows computer to be used as a terminal or modem. With power off, install in any slot except 0 (slot 2 recommended). Requires firmware (one EPROM).

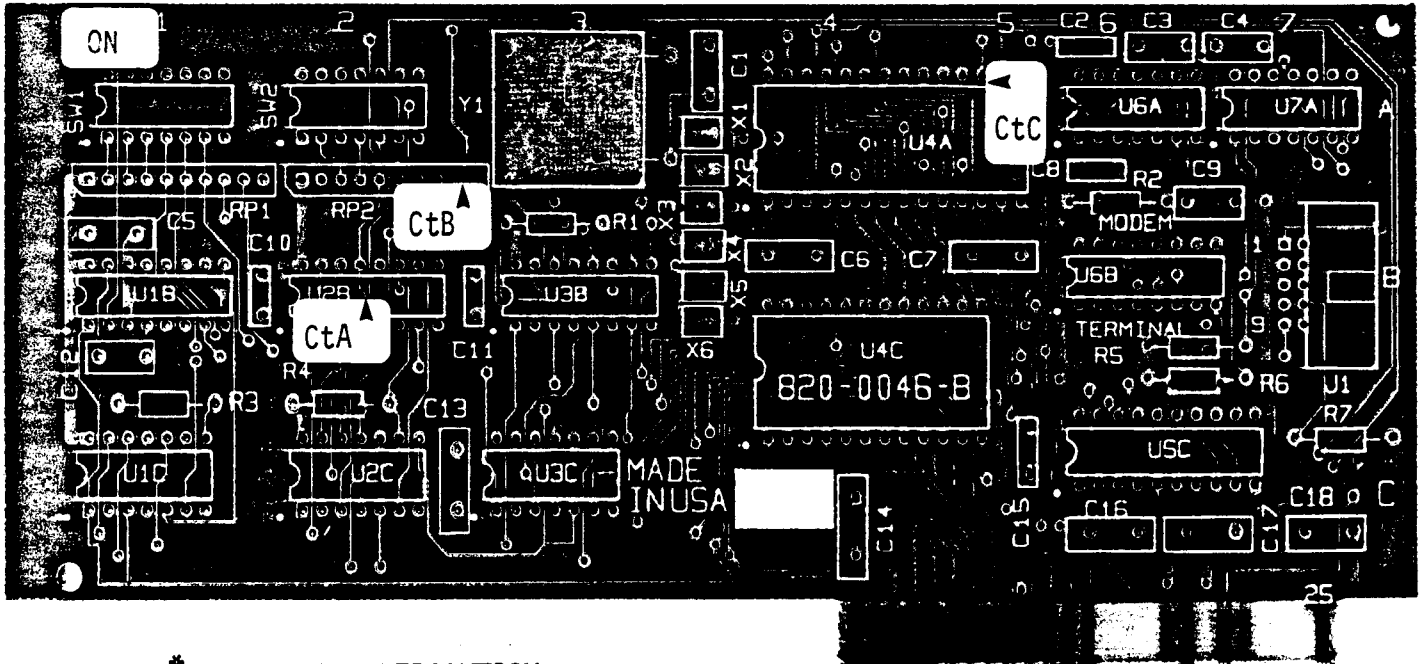

SEQUENCE *INDICATES A PERCAUTION

*MODIFICATIONS: Cut three traces on the component side as shown on the layout @ CtA, CtB, & CtC

RESISTORS R 1/4 watt, 5%

- 3 - 100 Ω @ R3,4,7
 - 1 - 3.3 KΩ @ R1
 - 3 - 15 KΩ @ R2,5,6
 - 2 - 3.3 KΩ 10-pin SIP @ RP1, RP2
- *Match pin 1 of SIPs with pin 1 (square pad) on the layout

SOCKETS *Match pin 1 of sockets with pin 1 (white dot) on the layout. Check that ALL pins have passed thru ALL holes

- 7 - 14-pin
 - 2 - 16-pin
 - 1 - 20-pin
 - 1 - 24-pin
 - 1 - 28-pin
- pin 1 lower left for ALL sockets

CAPACITORS C *Delete capacitor @ C1

- 1 - 220 pF @ C12
- 3 - 330 pF @ C3,4,9
- 1 - 0.001 μF @ C18
- 7 - 0.01 μF @ C5,6,7,13,14,16,17
- 5 - 0.1 μF @ C2,8,10,11,15

SWITCHES

- 2 - 7-position DIP @ SW1,2

CRYSTAL Y

1 - 2.472 @ Y1 *Install with field

CONNECTOR

1 - 2x5 male header strip, 90°, @ J1

INTEGRATED CIRCUITS *Match pin 1 of ICs with pin 1 (white dot) on the layout

- 1 - 74LS00 @ U2C
- 1 - 74LS11 @ U1C
- 1 - 74LS32 @ U3C
- 1 - 74LS245 @ U5C
- 1 - 74LS279 @ U1B
- 2 - 74LS365 @ U2B, U3B
- 1 - 1488 @ U6A
- 1 - 1489 @ U7A
- 1 - 6551 MPU, ACIA @ U4A
- 1 - 2716 EPROM @ U4C

PLUG-IN-ADAPTER one 16-pin component carrier strapped as shown to reconfigure socket @ U6B for either modem or terminal use

this end towards keyboard for terminal use

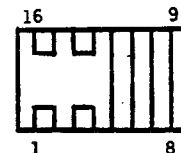

this end towards keyboard for modem use

RIBBON CABLE with appropriate connectors

Pin out for J1 includes:

CARD DB25	CARD DB25	CARD DB25	CARD DB25
1	1	6	6
2	2	7	19
3	3	8	7
4	4	9	20
5	5	10	8



SUPER SERIAL CARD: Serial interface between computer and various devices including printer, terminal, plotter, modem. With power off, install in any slot except 0 (slot #2 recommended). Requires firmware (one EPROM).

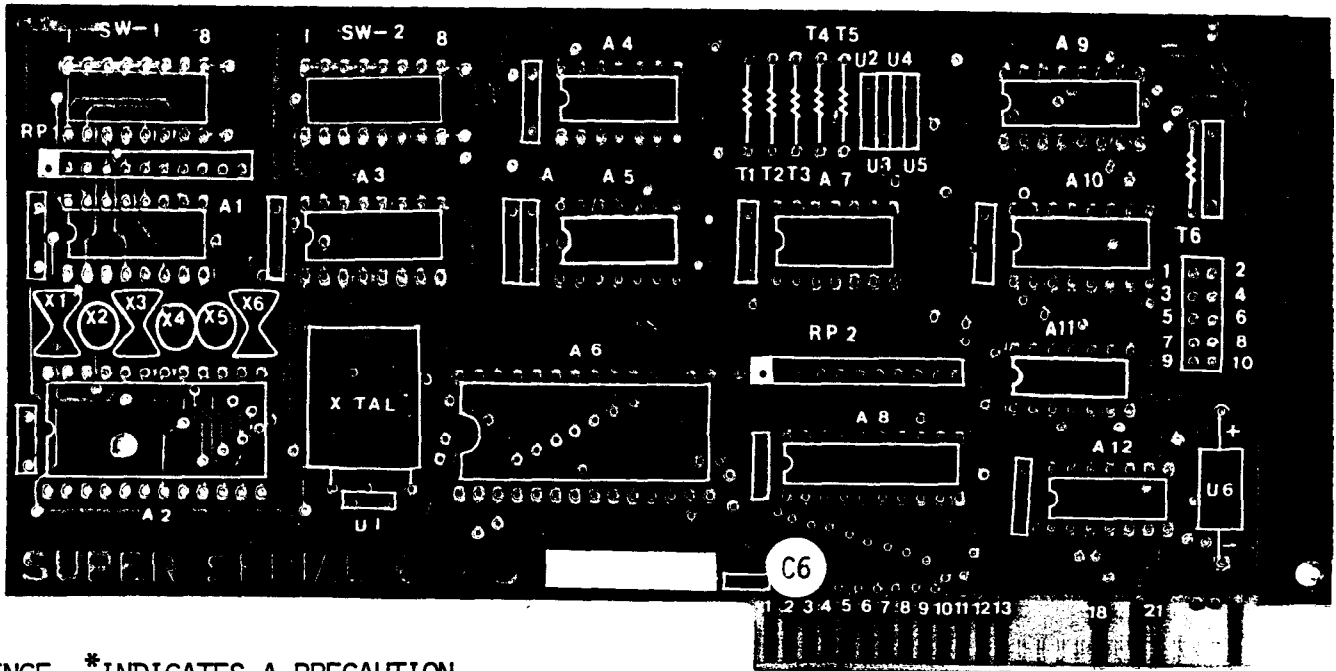

SEQUENCE *INDICATES A PRECAUTION

RESISTORS R 1/4 watt, 5%

- ___ 2 - 120 Ω @ T5,6
 - ___ 1 - 1 KΩ @ T1
 - ___ 3 - 12 KΩ @ T2,3,4
 - ___ 2 - 1 KΩ 11-pin SIP* bussed @ RP1,2
- *Match pin 1 of SIPs with pin 1 (square) on the layout

SOCKETS *Match pin 1 of sockets with pin 1 on the layout. Check that ALL pins have passed thru ALL holes

- ___ 5 - 14-pin
- ___ 3 - 16-pin
- ___ 1 - 20-pin
- ___ 1 - 24-pin
- ___ 1 - 28-pin

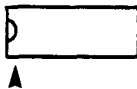

CAPACITORS C Delete capacitor @ C6

- ___ 1 - 22 pF @ U1
 - ___ 4 - 0.0033 μF @ U2,3,4,5
 - ___ 11 - 0.1 Monolithic @ [diagram]
 - ___ 1 - 10 μF/25V Axial* @ U6
- *Match + of Axial with + on the layout

CRYSTAL Y *Fold crystal flat against the card before soldering. Ground crystal to card

- ___ 1 - 1.8432 MHz @ X TAL

SWITCHES

- ___ 3 - 8-position DIP @ SW-1, SW-2, A9
- *Switch @ A9 reconfigures header @ T6 for terminal or modem use

CONNECTOR

- ___ 1 - 2x5 header, male, 90°, @ T6

INTEGRATED CIRCUITS *Match pin 1 of ICs with pin 1 on the layout

- ___ 1 - 74LS11 @ A12
- ___ 1 - 74LS32 @ A11
- ___ 1 - 74LS37 @ A7
- ___ 1 - 74LS245 @ A8
- ___ 1 - 74LS279 @ A10
- ___ 2 - 74LS365 @ A1,3
- ___ 1 - MC1488 @ A5
- ___ 1 - MC1489 @ A4
- ___ 1 - 6551A MPU @ A6
- ___ 1 - 2716 EPROM @ A2

RIBBON CABLE with appropriate connectors pinout for T6 as follows:

CARD	BD25	CARD	DB25
1	1	6	6
2	2	7	19
3	3	8	7
4	4	9	20
5	5	10	8



GUIDE 7-1

K-MODEM300: Direct connection to telephone line; allows for auto dialing and ring-detect for auto answering. Has built-in RS232 I/O for flexibility of application. With power off, install in any slot except 1 or 6. Requires software (one disk). User manual available from supplier.

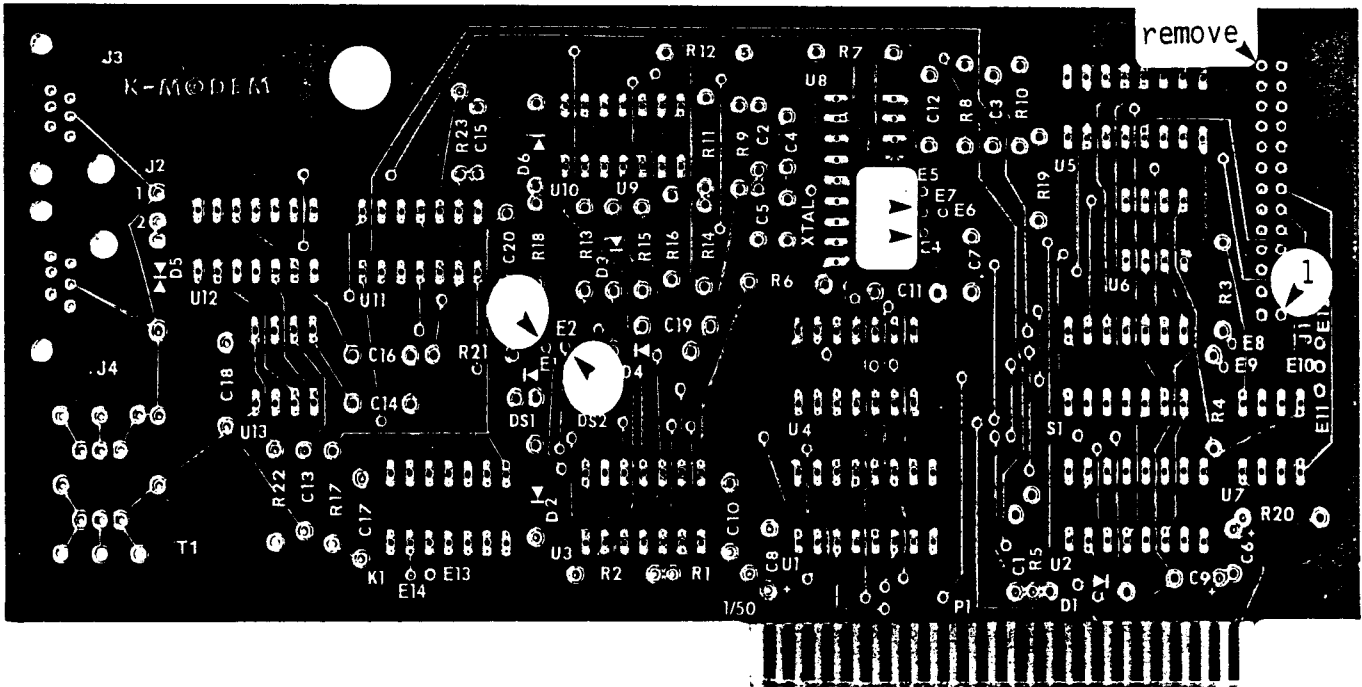

SUGGESTED ORDER OF INSTALLATION

*INDICATES A PRECAUTION

DIODES D (Delete D5)

*Position banded end (cathode) of diodes as shown



- 1 - 1N914 @ D1
 - 2 - 1N4004 @ D2,6
 - 2 - 1N751A 5.1 Zener @ D3,4
 - 2 - RLC210 (Dialco) LED* @ DS1,2
- *Match the "DOT" (cathode) on the LEDs with the cathode end on the layout

RESISTORS R 1/4 watt, 5%

- 1 - 560 Ω @ R16
- 2 - 1 KΩ @ R10,18
- 3 - 4.7 KΩ @ R17,19,20
- 12 - 10 KΩ @ R1,2,3,4,5,6,7,8,12, R14,15,21
- 1 - 6.8 KΩ @ R11
- 1 - 47 KΩ @ R23
- 1 - 100 KΩ @ R13
- 2 - 10 MΩ @ R9,22

SOCKETS *Match pin 1 of sockets with pin 1 (Ux) on the layout. Check that ALL pins have passed thru ALL holes before soldering.

SOCKETS (continued)

- 3 - 8-pin
 - 6 - 14-pin
 - 3 - 16-pin Ux
 - 1 - 18-pin
- ▲ pin 1

CAPACITORS C

- 2 - 15 pF disc ceramic @ C4,5
 - 1 - 100 pF disc ceramic @ C16
 - 4 - 0.01 μF disc ceramic @ C2,14,15,19
 - 8 - 0.1 μF Monolithic @ C1,3,10,11,12, C17,18,20
 - 1 - 1 μF Radial @ C13
 - 4 - 22 μF/16v Tantalum* @ C6,7,8,9
- *Match + of capacitor with + on the layout

SWITCH

- 1 - 76SC04 (Grayhill) @ S1
- *all closed (towards the top)

TRANSFORMER

- 1 - 141H (Hammond) 600CT/600CT line matching @ T1

CRYSTAL Y

- 1 - 4.032 MHz @ XTAL

(continued)

NuScope Associates

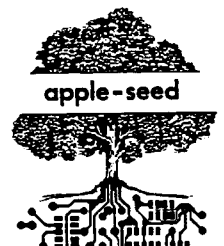

MODEM300 (continued)

CONNECTORS (Delete E3,5,6,8,9,10,11,12,13,14)

- ___ 2 - 2-pin headers, straight, @ E1-E2 & E4-E7 as shown on the layout
*Strap E1-E2 & E4-E7 for normal configuration
- ___ 1 - 2x13 male header strip, straight, @ J1 (RS232 port). Remove header pin as shown on the layout
*Note position of pin 1 on the layout
- *Install EITHER A OR B connector for telephone cable
- A ___ 1 - permanent telephone cable of appropriate length terminating in a modular telephone plug
*Connect cable leads as shown

OR

- J2
- 1 ● green lead Secure cable via ties at two
- 2 ● red lead large holes @ left of J2

- B ___ 2 - modular telephone jacks, 6-pin PCB mount @ J3 and/or J4 (for second outlet)

RELAY

- ___ 1 - MRR1ADS-5v (Struthers-Dunn) @ K1

INTEGRATED CIRCUITS *Match pin 1 of ICs with pin 1 (Ux) on the layout

- ___ 1 - 74LS174 @ U1
- ___ 1 - 74LS367 @ U2
- ___ 1 - 7406 @ U3
- ___ 1 - 74LS32 @ U4
- ___ 1 - 75154 @ U5 RS232 Receiver
- ___ 2 - 75150 @ U6,7 RS232 Driver
- ___ 1 - TMS99532 @ U8 (T.I.) 103 Modem Chip
- ___ 1 - 4558TC @ U9 Dual Op Amp High Slew Rate
- ___ 1 - 4N37 @ U10 Opto Isolator
- ___ 2 - 74LS00 @ U11,12
- ___ 1 - NE555 @ U13 Timer



Ux
▲ where x represents IC number
pin 1

NOTE: ALTERNATE SEQUENCE

As this card appears to be "cluttered" it may be simpler to install ALL sockets first. Study the card thoroughly before beginning.

GUIDE 7-2

MODEM CARD: Direct connect to telephone line featuring 110 & 300 baud, half or full duplex, auto-answer/auto-dial. touch tone or pulse dialing. With power off, install in slot 2. Requires firmware (one EPROM).

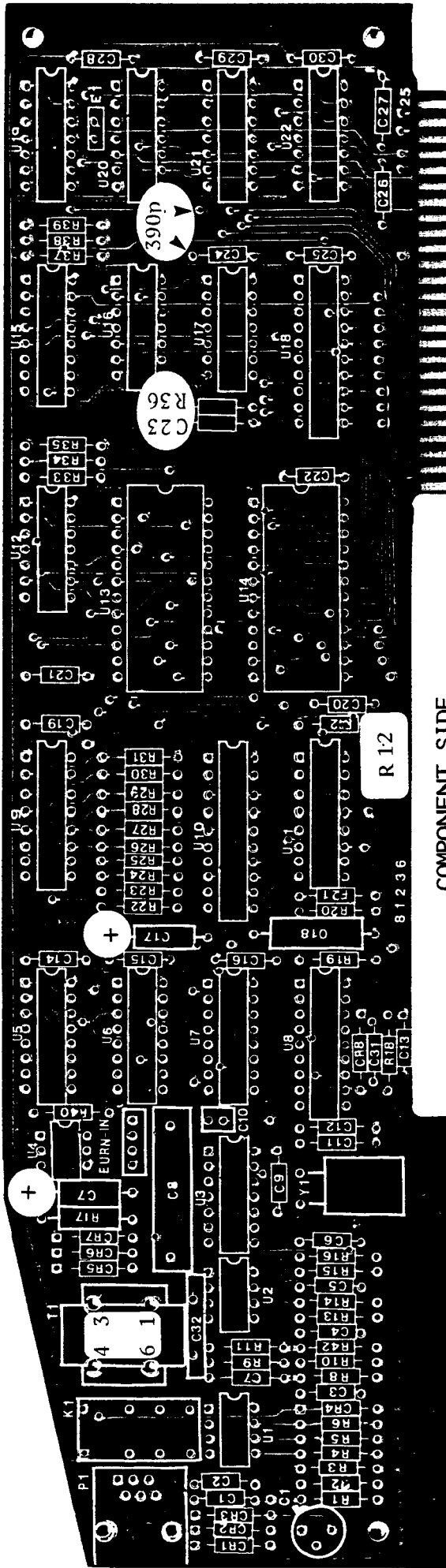

COMPONENT SIDE

SEQUENCE *INDICATE A PRECAUTION INSTALL TALLEST COMPONENTS LAST

DIODES D *Position banded end of diode towards the SQUARE pad

- 2 - 1N4735A 6.2 V Zener @ CR1,2
- 2 - 1N4148 Switching @ CR3,5
- 1 - 1N750A 4.7 V Zener @ CR4
- 1 - 1N5231B 5.1 V Zener @ CR8
- 2 - 1N5254B 27 V Zener @ CR6,7

RESISTORS R 1/4 watt, 1% Precision

- 1 - 150 KΩ @ R1
- 4 - 10.0 KΩ @ R2,7,8,15
- 1 - 348 Ω @ R9
- 2 - 12.1 KΩ @ R10,11
- 1 - 20.0 KΩ @ R42
- 1 - 4.99 KΩ @ R14
- 1 - 7.68 KΩ @ R16

1/2 watt, 5%

- 1 - 5.6 KΩ @ R17

RESISTORS (continued)

- 1/4 watt, 5%
 - 9 - 10 KΩ @ R3,5,21,33,34,35,37
 - R38,39
 - 1 - 3 MΩ @ R4
 - 1 - 13 KΩ @ R6
 - 1 - 2 KΩ @ R13
 - 1 - 560 Ω @ R18
 - 1 - 4.3 MΩ @ R19
 - 1 - 4.7 KΩ @ R20
 - 1 - 1 MΩ @ R22
 - 10 - 27 KΩ @ R23,24,25,26,27,28
 - R29,30,31,12
 - 1 - 470 Ω @ R36* Note position
 - 1 - 15 KΩ @ R40

TRANSISTOR *Position EBC leads as shown

- 1 - 2N3904 @ Q1



SOCKETS *Match pin 1 of sockets with pin 1 on the layout. Check that ALL pins have passed thru ALL holes

- 1 - 6-pin
- 2 - 8-pin
- 8 - 14-pin
- 6 - 16-pin
- 1 - 18-pin
- 2 - 20-pin
- 2 - 24-pin

CAPACITORS C *Match + of capacitors with + on the layout

- 23 - 0.1 μF Monolithic @ C1,2,3,4,5, C6,9,13,14,15,16,19,20,21,22, C24,25,26,27,28,29,30,31
- 2 - 3.3 μF/16v Tantalum* @ C7,17
- 1 - 0.47 μE/250v Polyester @ C8
- 1 - 390 pF disc ceramic @ C10

- TRANSFORMER
- 1 - 107H (Hammond) 1:1 600 Ω impedance line-matching remove pins 2 & 5; use ONLY pins 1,3,4,6
- INTEGRATED CIRCUITS *Match pin 1 of ICs with pin 1 on the layout
- 2 - 1458P @ U1,2
 - 1 - CD4011 @ U3
 - 1 - 4N35 @ U4
 - 2 - 14526B @ U5,6
 - 1 - CD4538 @ U7
 - 1 - TMS99532 Modem (T.I.) @ U8
 - 1 - 5089 (T.I.) @ U9
 - 1 - 74LS273 @ U10
 - 1 - 74LS174 @ U11
 - 1 - 74LS125 @ U12
 - 1 - 6850 @ U13
 - 1 - 2716 @ U14 EPROM
 - 1 - 74LS155 @ U15
 - 1 - 74LS132 @ U16
 - 1 - 74LS30 @ U17
- pin 1 upper right for ALL sockets & ICs
- 1 - 74LS245 @ U18
 - 1 - 74LS197 @ U19
 - 1 - 74LS14 @ U20
 - 1 - 74LS08 @ U21
 - 1 - 74LS21 @ U22

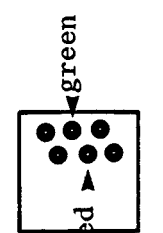
- MODEMCARD (continued)
- CAPACITORS (continued)
- 2 - 20 pF disc ceramic @ C11,12
 - 1 - 0.047 μ F/250v Mylar @ C18
 - 1 - 330 pF disc ceramic @ C23
 - 1 - 0.01 μ F/1 KV disc ceramic @ C32
 - 1 - 390 pF disc ceramic between U17 & U21 as shown on the layout
- CRYSTAL Y *Position body of crystal flat against the card before soldering
- 1 - 4.032 MHz @ Y1
- CONNECTORS
- 1 - 4-pin header, straight @ BURN IN
 - 1 - 2-pin header, straight @ E1
 - 1 - modular telephone jack, 6-pin PCB mount @ P1 *Connect leads as shown
- 
- RELAY
- 1 - RKT-12 (TAICO) or 275-213 (Radio Shack) 12 V DC DPDT DIP relay

MODIFICATIONS TO THE SOLDER SIDE Refer to layout below:
 CONNECT jumper wires on the SOLDER SIDE as shown @ A,B,C

- 1 - U20 pin 2 to U19 pin 8 @ A-A
- 1 - U21 pin 1 to U20 pin 1 @ B-B
- 1 - U1 pin 8 to thick track leading to +12 V (pin 50)@C

CUT track leading from pin 3, U21 on the SOLDER SIDE @ D

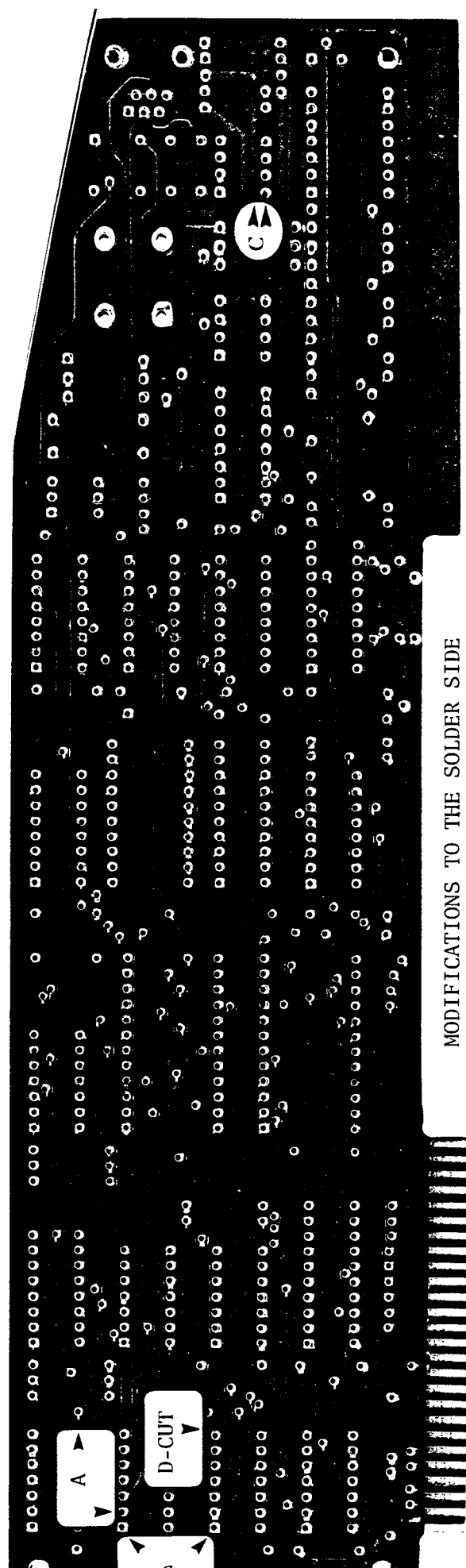

MODIFICATIONS TO THE SOLDER SIDE

GUIDE 7-3

RS232/MODEM: Offers serial I/O for external printer, terminal, or modem (300 BAUD). (1,200 BAUD available in future). Direct connect to telephone line featuring half/full duplex, auto-answer/auto-dial. With power off, install in any slot except 0 (slot 2 recommended). Requires firmware (one EPROM). Items labelled + are associated with the modem and may be omitted for serial use.

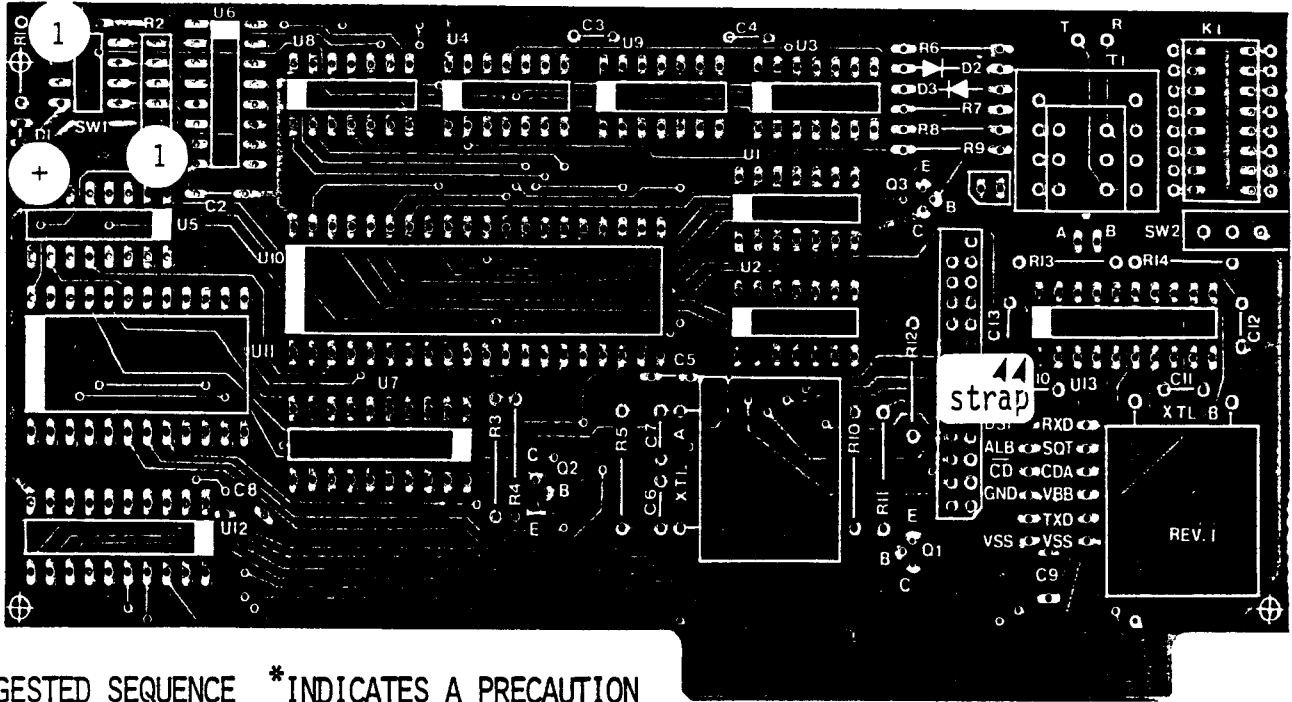

SUGGESTED SEQUENCE *INDICATES A PRECAUTION

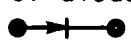
DIODES D *Position banded end (cathode) of diode as shown
 cathode end

2 - 1N914 @ D2,3
 1 - LED (red) @ D1 * Position longer lead (+) of LED as shown on the layout

RESISTORS R 1/4 watt, 5%
 1 - 330 Ω @ R1
 2 - 180 Ω @ R3,4
 + 1 - 600 Ω @ R14
 + 1 - 3.5 KΩ @ R13
 7 - 4.7 KΩ @ R6,7,8,9,10,11,12
 1 - 1 MΩ @ R5
 1 - 1 KΩ 5-pin SIP @ R2 *Position pin 1 (common) of SIP as shown on the layout

SOCKETS *Match pin 1 of sockets with pin 1 (square pad) on the layout. Check that ALL pins have passed thru ALL holes

7 - 14-pin
 1 - 16-pin
 3 - 20-pin
 1 - 24-pin
 1 - 40-pin



▲ pin 1 (square pad)

SOCKETS (continued) * Note: The extra 16-pin pad @ K1 is available for future expansion

CAPACITORS C
 2 - 27 pF @ C6,7
 7 - 0.1 μF Monolithic @ C1,2,3,4,5,8,9
 + 3 - 0.1 μF Monolithic @ C11,12,13
 + 1 - 1.5 μF/10V Tantalum* @ C10
 *Match + of capacitor C10 + U13 with + as shown

TRANSISTORS Q *Position the EBC leads as shown on the layout
 1 - 2N2904 @ Q1
 1 - 2N2906 @ Q2
 1 - 2N3906 @ Q3

CONNECTOR
 1 - 2x13 male header strip, straight
 *Remove upper left pin of header
 *Pin 1 is indicated by a cut corner on the layout

SWITCHES
 1 - 4-position DIP @ SW1 *NB pin 1 on layout
 + 1 - SP/DT @ SW2 Answer/Originate
 *Position switch so that the toggle extends beyond the card



RS232/MODEM (Continued)

TRANSFORMER T

- + _____ 1 - 630D (Hammond) or substitute pulse transformer, 1:1 turns ratio to fit the board. *NOTE: Use pads A & B for:
 - 1-other external transformer
 - 2-future 1,200 BAUD IC modification

MODIFICATION ON THE COMPONENT SIDE

- _____ 1 - Connect a jumper wire between C13 and the track from R13 as shown on the COMPONENT SIDE on the layout

CRYSTALS Y *Position body of crystal against card.*Insulate card from crystal with

- _____ 1 - 1.8432 MHz @ XTL A tape
- + _____ 1 - 3.5795 MHz @ XTL B

RE MODEM CHIP

Refer to the National Semiconductor MM74HC942 300 Baud Modem Data Sheet for characteristics, applications, schematics and connection diagrams.

TELEPHONE CABLE

- + _____ 1 - telephone cable of appropriate length terminating in a modular telephone plug
 - *Connect cable leads to T (Tip) and R (Ring)

INTEGRATED CIRCUITS *Match pin 1 of ICs with pin 1 on the layout

- _____ 1 - 74LS04 @ U4
- _____ 1 - 74LS08 @ U3
- _____ 1 - 74LS10 @ U8
- _____ 1 - 74LS74 @ U9
- _____ 1 - 74LS175 @ U5
- _____ 2 - 74LS245 @ U7,12
- _____ 1 - 74LS367 @ U6
- _____ 1 - 1488 @ U1
- _____ 1 - 1489 @ U2
- _____ 1 - 8250 @ U10
- _____ 1 - 2716 EPROM @ U11
- + _____ 1 - 74HC942 Modem IC (NAT) @ U13

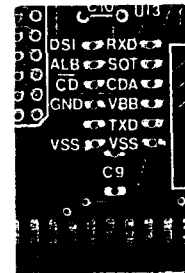

GUIDES 8-1 & 8-2

MUSIC SYSTEM: Consists of an analog card (CARD 1) interfaced with a digital card (CARD 2). Allows user to compose music, save it on disk and print copies of musical scores. With power off, install the connected cards in any two consecutive slots (except 0) with CARD 1 in the LOWER numbered slot. Requires software (two disks) and documentation.

MUSIC CARD 1

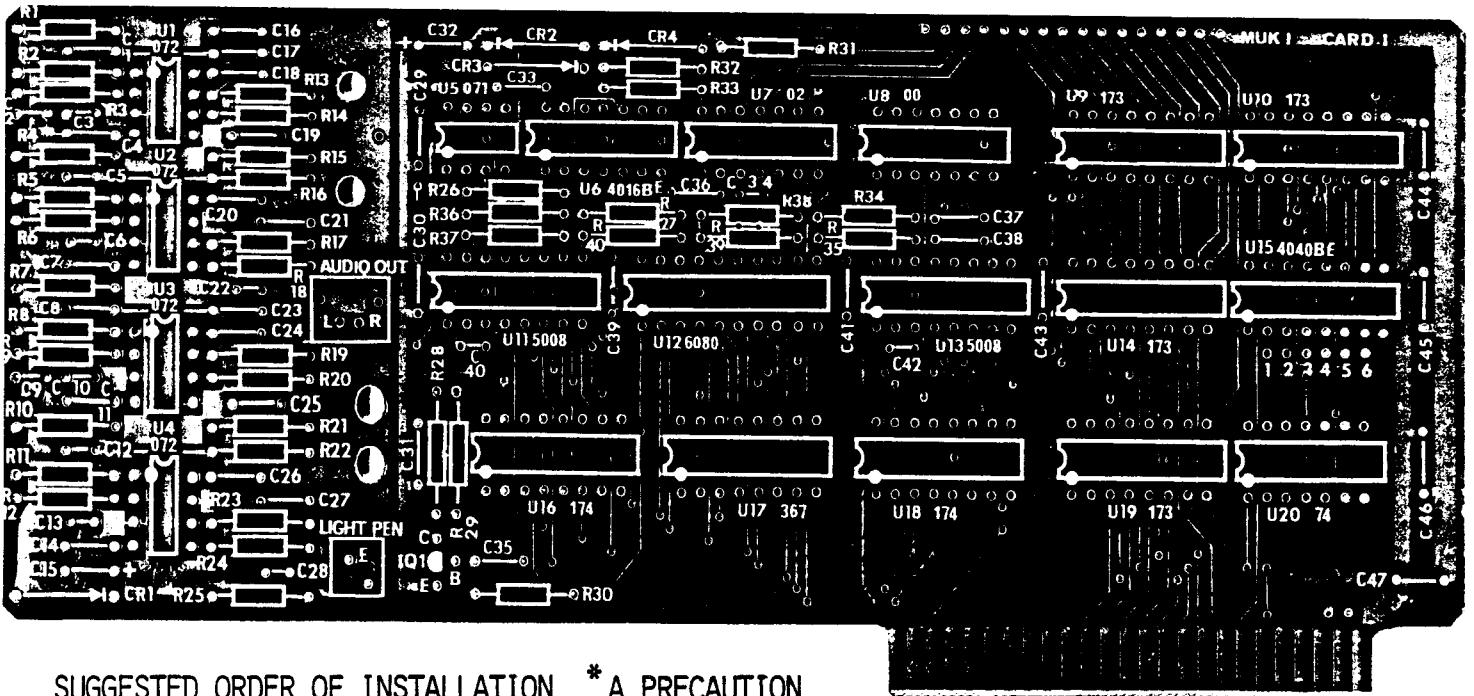

SUGGESTED ORDER OF INSTALLATION * A PRECAUTION

DIODES D *position banded end (cathode) of diode toward the arrow as shown

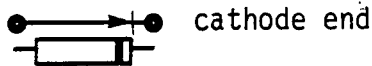

- 2 - 1N757A 9.1 V Zener @ CR1,4
- 2 - 1N4148 @ CR2,3

- RESISTORS R** 1/4 watt, 5%
- 2 - 100 Ω @ R25,31
 - 1 - 220 Ω @ R39
 - 2 - 240 Ω @ R13,19
 - 4 - 470 Ω @ R26,36,37,38
 - 2 - 1 KΩ @ R33,40
 - 1 - 3 KΩ @ R34
 - 3 - 4.7 KΩ @ R27,28,35
 - 1 - 6.2 KΩ @ R32
 - 2 - 6.8 KΩ @ R15,21
 - 2 - 12 KΩ @ R1,7
 - 2 - 18 KΩ @ R4,10
 - 2 - 33 KΩ @ R3,9
 - 2 - 36 KΩ @ R2,8
 - 4 - 51 KΩ @ R6,12,16,22
 - 2 - 56 KΩ @ R14,20
 - 4 - 100 KΩ @ R5,11,29,30
 - 2 - Jumper @ R17,23
 - 2 - Blank @ R18,24

SOCKETS *Match pin 1 of sockets with pin 1 (white dot) on the layout. Check that ALL pins have passed thru ALL holes

- 5 - 8-pin
- 4 - 14-pin
- 10 - 16-pin
- 1 - 20-pin

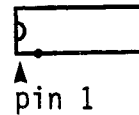

- CAPACITORS C**
- 1 - 27 pF Mica @ C40
 - 2 - 47 pF Mica @ C6,13
 - 1 - 100 pF Mica @ C42
 - 4 - 220 pF Mica @ C3,10,22,28
 - 4 - 0.001 μF @ C2,5,9,12
 - 1 - 0.01 μF @ C34
 - 32 - 0.1 μF Monolithic @ C1,4,7,8,11,14, C16,17,18,19,20,21,23,24, C25,26,27,29,30,31,33,35, C36,37,38,39,41,43,44,45, C46,47
 - 2 - 10 μF/25v Tantalum* @ C15,32
- *Match + of capacitor with + on layout

CONNECTOR

- 1 - 1x16 female header, 8 mm deep
- *To interface with 1x16 male header of CARD 2



MUSIC SYSTEM I (continued)

TRANSISTOR Q *Install the three EBC transistor leads correctly

1 - 2N2222A @ Q1

INTEGRATED CIRCUITS *Match pin 1 of IC with pin 1 on the layout

- 1 - 74LS00 @ U8
- 1 - 74LS02 @ U7
- 1 - 74LS74 @ U20
- 4 - 74LS173 @ U9,10,14,19
- 2 - 74LS174 @ U16,18
- 1 - 74LS367 @ U17
- 4 - TL072 @ U1,2,3,4
- 1 - TL071 @ U5
- 1 - CD4016BE @ U6
- 1 - CD4040BE @ U15
- 2 - NE5008 @ U11,13
- 1 - AM6080 (AMD) @ U12

AUDIO OUTPUT CABLE

Shielded cable of appropriate length terminating in RCA dual phono plugs. For stereo, connect stripped end to jumper pins as shown

- L = Left channel
- R = Right channel
- GND = Ground

Secure cable with an insulated tie thru the two large holes

LIGHT PEN IMPROVISE!!

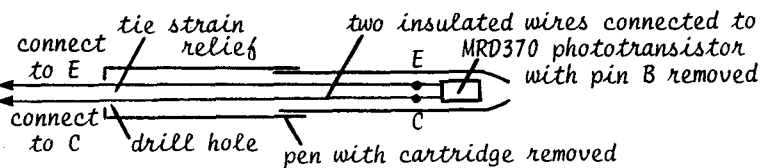
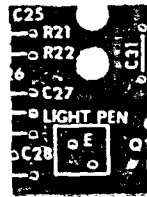
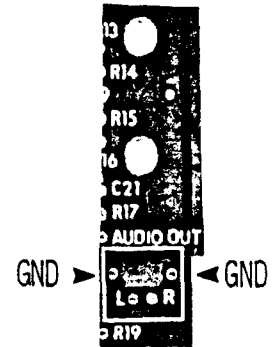

MUSIC CARD 2

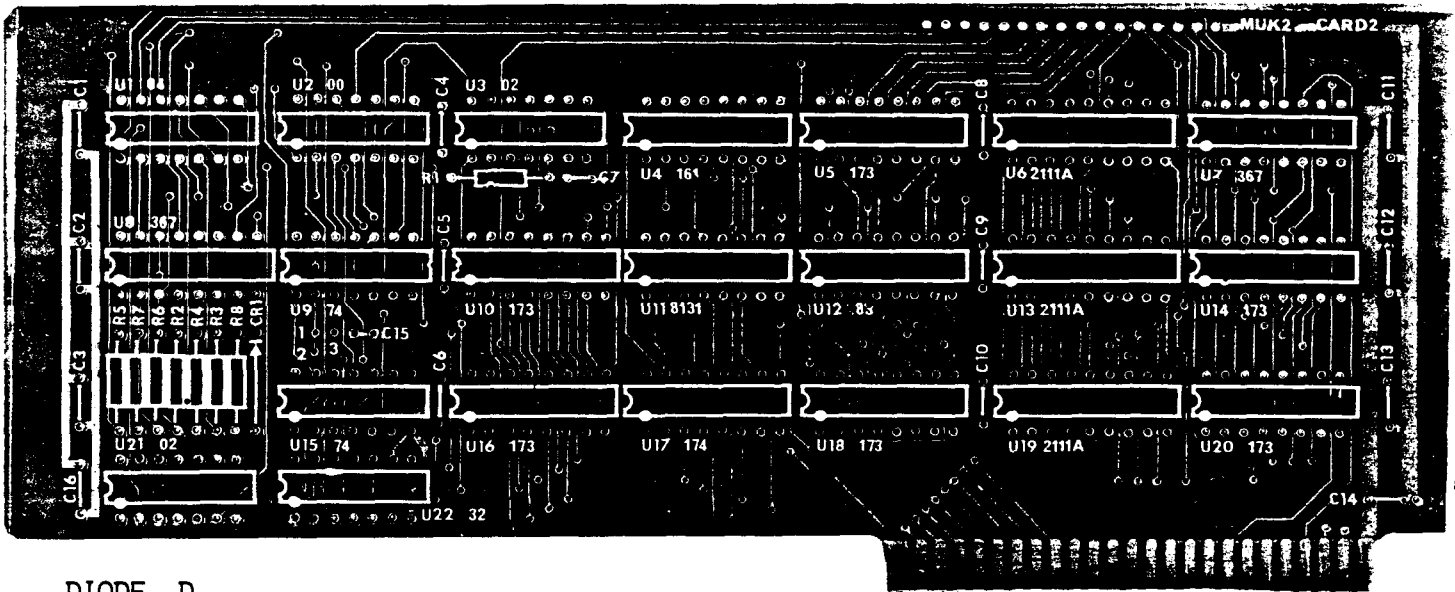

DIODE D
1 - 1N4148 @ CR1

RESISTORS R 1/4 watt 5%
4 - 1 KΩ @ R1,2,5,8
2 - 1.2 KΩ @ R4,7
2 - 4.7 KΩ @ R3,6

SOCKETS
7 - 14-pin
12 - 16-pin
3 - 18-pin

CAPACITORS C
1 - 100 pF Mica @ C7

INTEGRATED CIRCUITS

- 1 - 74LS00 @ U2
- 2 - 74LS02 @ U3,21
- 1 - 74LS04 @ U1
- 1 - 74LS32 @ U22
- 2 - 74LS74 @ U9,15
- 1 - 74LS83 @ U12
- 1 - 74LS161 @ U4
- 6 - 74LS173 @ U5,10,14,16,18,20
- 1 - 74LS174 @ U17
- 2 - 74LS367 @ U7,8
- 1 - DM8131 (NAT) @ U11

VOICE MACHINE: Versatile, high-quality speech synthesizer created entirely in software. Uses the phonetic alphabet. Type the word and produce the sound. With power off, install in slot number 5. Requires software (one disk).

COMPONENT SIDE
OF CARD

Single-layer, single-sided peripheral circuit card. Install components on the COMPONENT SIDE and solder to the SOLDER SIDE

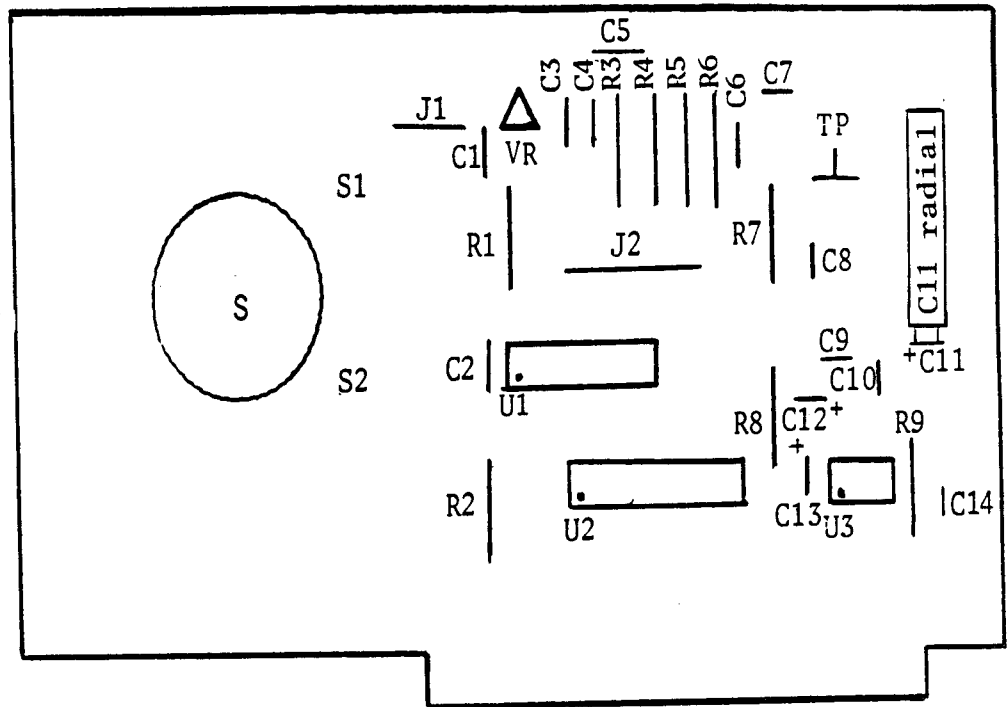

SEQUENCE *INDICATES A PRECAUTION

RESISTORS R 1/4 watt, 5%

- _____ 1 - 11 Ω @ R9
- _____ 1 - 560 Ω @ R3
- _____ 2 - 2 KΩ @ R2,4
- _____ 1 - 3.3 KΩ @ R1
- _____ 3 - 10 KΩ @ R5,7,8
- _____ 1 - 220 KΩ @ R6
- _____ 1 - 5 KΩ trimpot, @ TP

SOCKETS *Match pin 1 of sockets with pin 1 (dot) on the layout. Check that ALL pins have passed thru ALL holes

- _____ 1 - 8-pin
- _____ 1 - 16-pin
- _____ 1 - 20-pin

CAPACITORS C

- _____ 1 - 0.005 μF @ C7
- _____ 3 - 0.02 μF @ C5,6,9
- _____ 7 - 0.1 μF Monolithic @ C1,2,3,4, C8,10,14
- _____ 1 - 470 μF/16v radial* @ C11
- _____ 1 - 10 μF/16v radial* @ C12
- _____ 1 - 1 μF/16v radial* @ C13

*Match + of radial capacitors with + on the layout

JUMPER

- _____ 2 - @ J1,2

VOLTAGE REGULATOR

- _____ 1 - 7805 +5V @ VR
- *Position "flat" part of device towards the top of the card

SPEAKER S

- _____ 1 - small, 8Ω @ S
- Secure speaker in S opening and solder the two leads to S1 and S2

INTEGRATED CIRCUITS *Match pin 1 of ICs with pin 1 (dot) on the layout

- _____ 1 - MC1408PB @ U1
- _____ 1 - 74LS273 @ U2
- _____ 1 - LM386 @ U3

pin 1



GUIDE 8-4

THE YAPPLE CARD: By typing the word using the phonetic alphabet, this speech synthesizer allows the user to blend sounds together into most English utterances. With power off, install in slot number 4. Requires software (one disk). User manual available from supplier.

COMPONENT SIDE

Single-layer, single-sided circuit card
 *Install components on the component side & solder to solder side

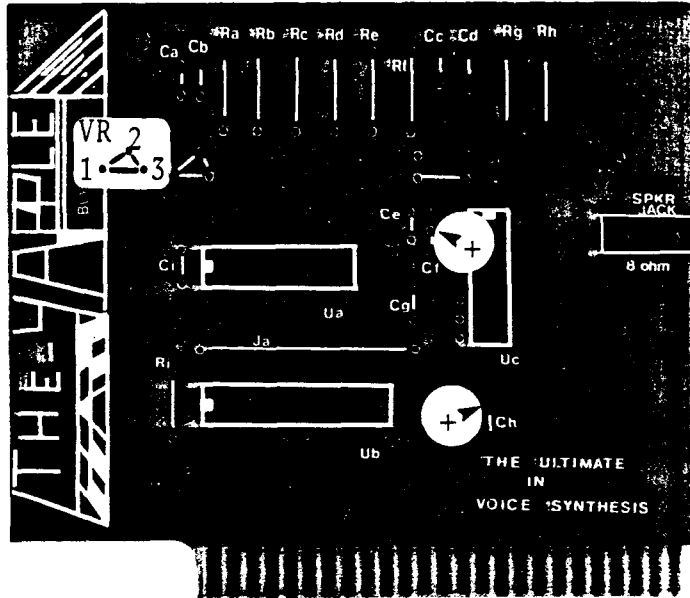

SUGGESTED SEQUENCE *INDICATES A PRECAUTION

RESISTORS R 1/4 watt, 5%

- ___ 2 - 5.6 KΩ @ Ra,d
- ___ 1 - 560 Ω @ Rb
- ___ 2 - 2.2 KΩ @ Rc,i
- ___ 1 - 220 Ω @ Re
- ___ 1 - 10 KΩ @ Rf
- ___ 2 - 1 KΩ @ Rg,j
- ___ 1 - 47 KΩ @ Rh

SOCKETS *Match pin 1 of sockets with pin 1 on the layout. Check that ALL pins have passed thru ALL holes

- ___ 1 - 14-pin
- ___ 1 - 16-pin
- ___ 1 - 20-pin

CAPACITORS C

- ___ 5 - 0.1 μF @ Ca,b,e,g,i
 - ___ 2 - 0.047 μF @ Cc,d
 - ___ 1 - 10 μF/16V radial* @ Cf
 - ___ 1 - 220 μF/16V radial* @ Ch
- *Match + of radial capacitors with + on the layout

VOLTAGE REGULATOR

- ___ 1 - 78L05 5V @ VR *Position the three leads as shown on layout

SPEAKER AND CONNECTORS

- ___ 2 - male header pins, straight @ SPKR JACK
- ___ 1 - 10-20 cm, 8-ohms speaker in vented box; connect speaker wires to jack

INTEGRATED CIRCUITS *Match pin 1 of ICs with pin 1 on the layout

- ___ 1 - MC1408 @ Ua
 - ___ 1 - 74LS273 @ Ub
 - ___ 1 - LM380 @ Uc
- ▲ pin 1



GUIDE 8-5

MUSIC MACHINE: A nine-voice card that allows user to enter, modify, play, and create music. With power off, install in slot number 5. Requires software, documentation, paddles, and home stereo system.

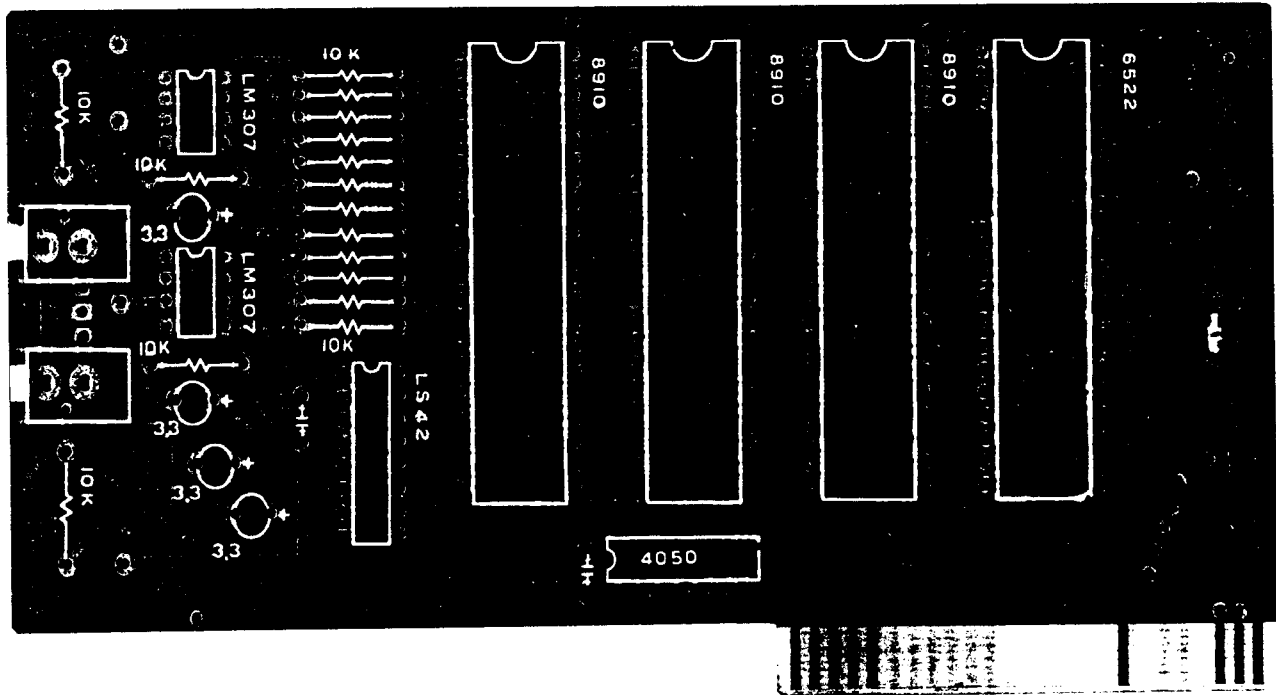

SEQUENCE *INDICATES A PRECAUTION

RESISTORS $\frac{1}{4}$ watt, 5%
 _____ 16 - 10 K Ω

SOCKETS *Match pin 1 of sockets with pin 1 on the layout. Check that ALL pins have passed thru ALL holes
 _____ 2 - 8-pin
 _____ 2 - 16-pin
 _____ 4 - 40-pin

CAPACITORS C
 _____ 3 - 0.1 μ F Monolithic @ location:
 _____ 4 - 3.3 μ F/25v Tantalum* Match + of capacitor with + on the layout

JACKS
 _____ 2 - audio jacks, PCB mount

CABLES
 _____ 2 - audio cables to suit

INTEGRATED CIRCUITS *Match pin 1 of IC with pin 1 on layout

_____ 2 - LM307
 _____ 1 - 74LS42
 _____ 1 - CD4050
 _____ 1 - 6522 VIA
 _____ 3 - 8910 (General Instruments) programmable sound generator

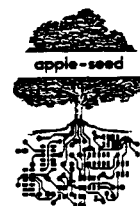
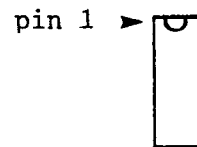

THREE-VOICE SYNTHESIZER CARD: Computer-controlled music that plugs into a home stereo system. Each voice has control of pitch, envelope, & volume. Use one card for mono; two for stereo. With power off, install in any slot (number 4 recommended). Requires software & documentation.

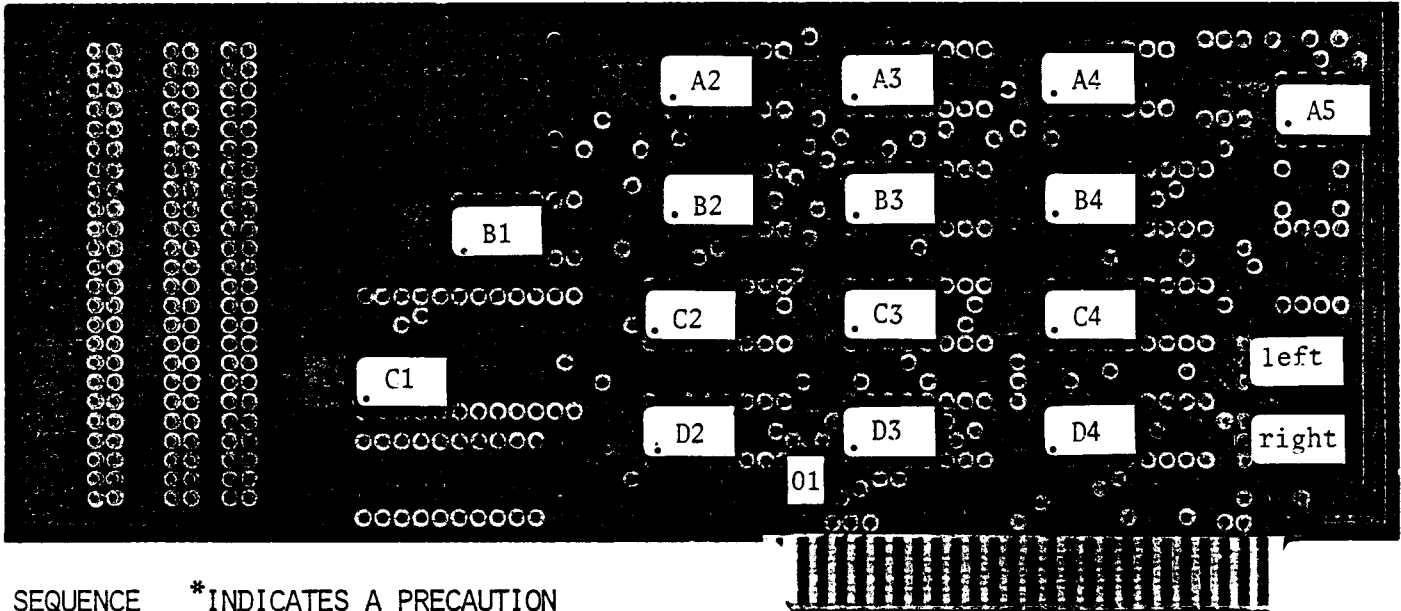

SEQUENCE *INDICATES A PRECAUTION

RESISTORS R ¼ watt, 5%

- ___ 2 - 470 Ω
- ___ 2 - 1 KΩ
- ___ 2 - 2 KΩ
- ___ 14 10 KΩ

SOCKETS *Match pin 1 of sockets with pin 1 (dot) on the layout. Check that ALL pins have passed thru ALL holes

- ___ 1 - 8-pin
 - ___ 4 - 14-pin
 - ___ 6 - 16-pin
 - ___ 3 - 18-pin
 - ___ 1 - 24-pin
- pin 1 lower left for ALL sockets and ICs

CAPACITORS C

- ___ 6 - 0.1 μF Monolithic @ ● 01 ●
- ___ 3 - 6.8 μF/35V Tantalum* @ ● 68 ●

*Match + of capacitors with + on the layout

CONNECTORS

- ___ 2 - 1X3 male header strip, 90° @left & right, for audio output

VOLTAGE REGULATOR

- ___ 1 - 7805UC *Install three leads as shown



CRYSTAL Y

- ___ 1 - 1.7800 MHz @ XTAL *Position the crystal flat against the card before soldering

INTEGRATED CIRCUITS *Match pin 1 of ICs with pin 1 (dot) on the layout

- ___ 1 - 74LS624 (74LS324) @ B1
- ___ 1 - 8253 @ C1
- ___ 1 - 74LS32 @ A2
- ___ 1 - 74LS04 @ B2
- ___ 2 - 74LS75 @ C2, D2
- ___ 4 - CD4723B @ A3, B3, C3, D3
- ___ - Access Socket (empty) @ A4
- ___ 3 - 8227DP @ B4, C4, D4
- ___ 1 - LM307 @ A5

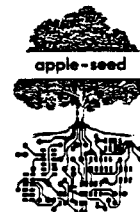

INSTRUMENT SYNTHESIZER: A digital music synthesizer consisting of two cards (MK1 & MK2) to interface with a 5-octave organ keyboard, & one interface card that connects the keyboard to the computer (slot 2). Allows music to be played directly or recorded and recalled later. Requires pair of Music Cards (GUIDES 8-1 & 2) in slots 4 & 5 and software (5 disks). Available as three bare cards or complete system only.

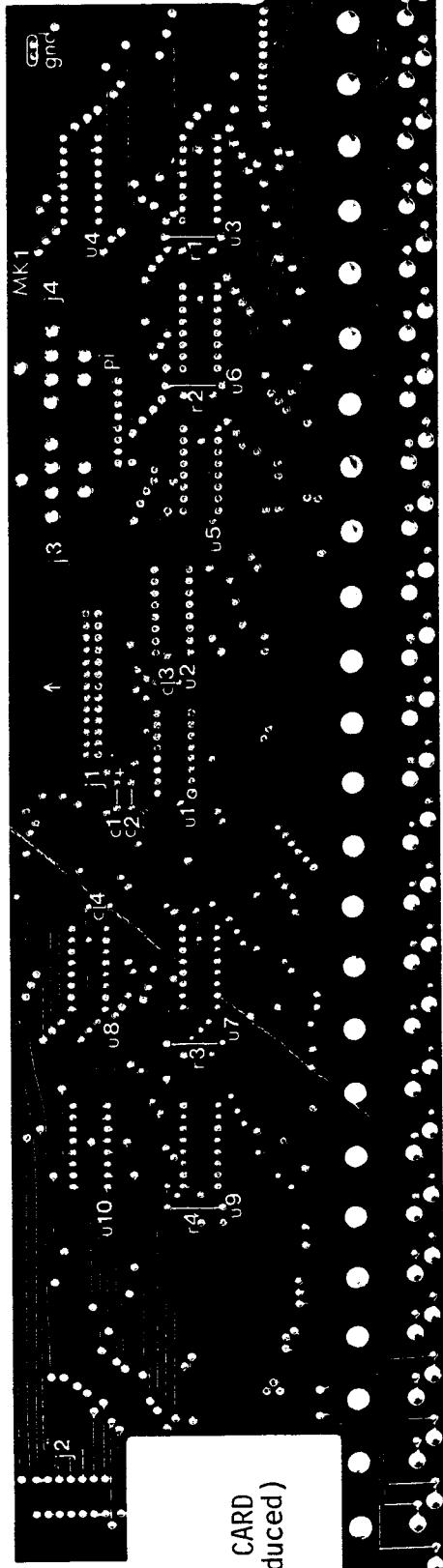

MK1 CARD
(reduced)

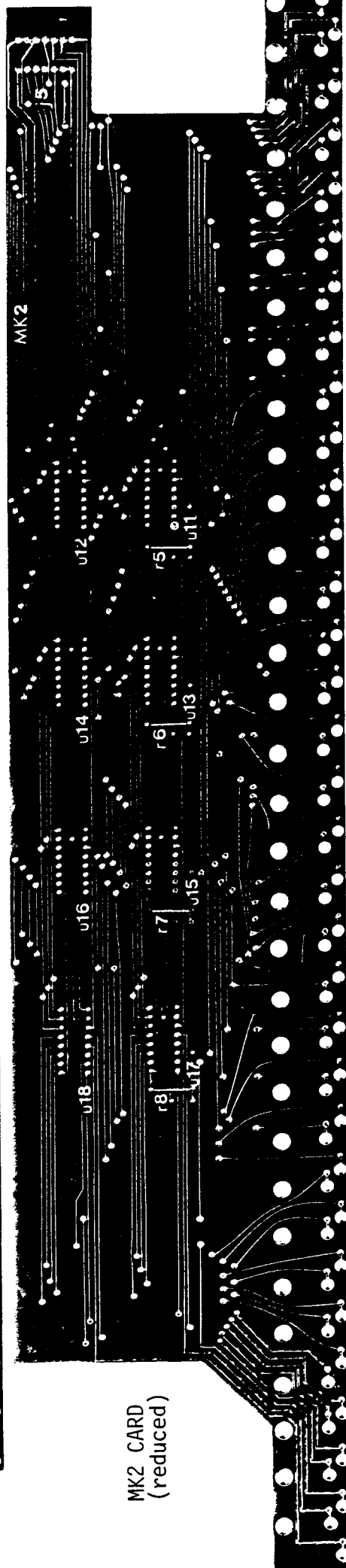

MK2 CARD
(reduced)

SUGGESTED ORDER OF INSTALLATION *INDICATES A PRECAUTION *THE FOLLOWING REFERS TO BOTH THE MK1 & MK2 CARDS

RESISTORS R 1/4 watt, 5%

- 8 - 3 KΩ @ r1,2,3,4,5,6,7,8

SOCKETS *Match pin 1 of sockets with pin 1, lower left, on the layout.

Check that ALL pins have passed thru

ALL holes

- 18 - 16-pin

- 2 - 14-pin @ j2 & j5

CAPACITORS C

- 3 - 0.1 μF Monolithic @ c2,3,4

- 1 - 10 μF/16V Tantalum* @ c1*Match + of capacitor with + on layout

INTEGRATED CIRCUITS *Match pin 1 of ICS

pin 1 on the layout

- 2 - 74LS368 @ u1,2

- 16 - 4051BE @ u3,4,5,6,7,8,9,10,11, u12,13,14,15,16

CONNECTORS

- 2 - stereo jacks, PCB mount, @ j3,4, for foot pedals (Roland, model DP2, pedal switch)

- 1 - 2x13 male header strip, right angle @ J1

- 1 - 20 cm length of insulated

wire at gnd (refer to installation instructions for hookup)

INSTRUMENT SYNTHESIZER (Continued) (8-7, 8-8, 8-9)

Solder Side of MK1 & MK2; Bottom View of Keyboard.
Close to Actual Size.

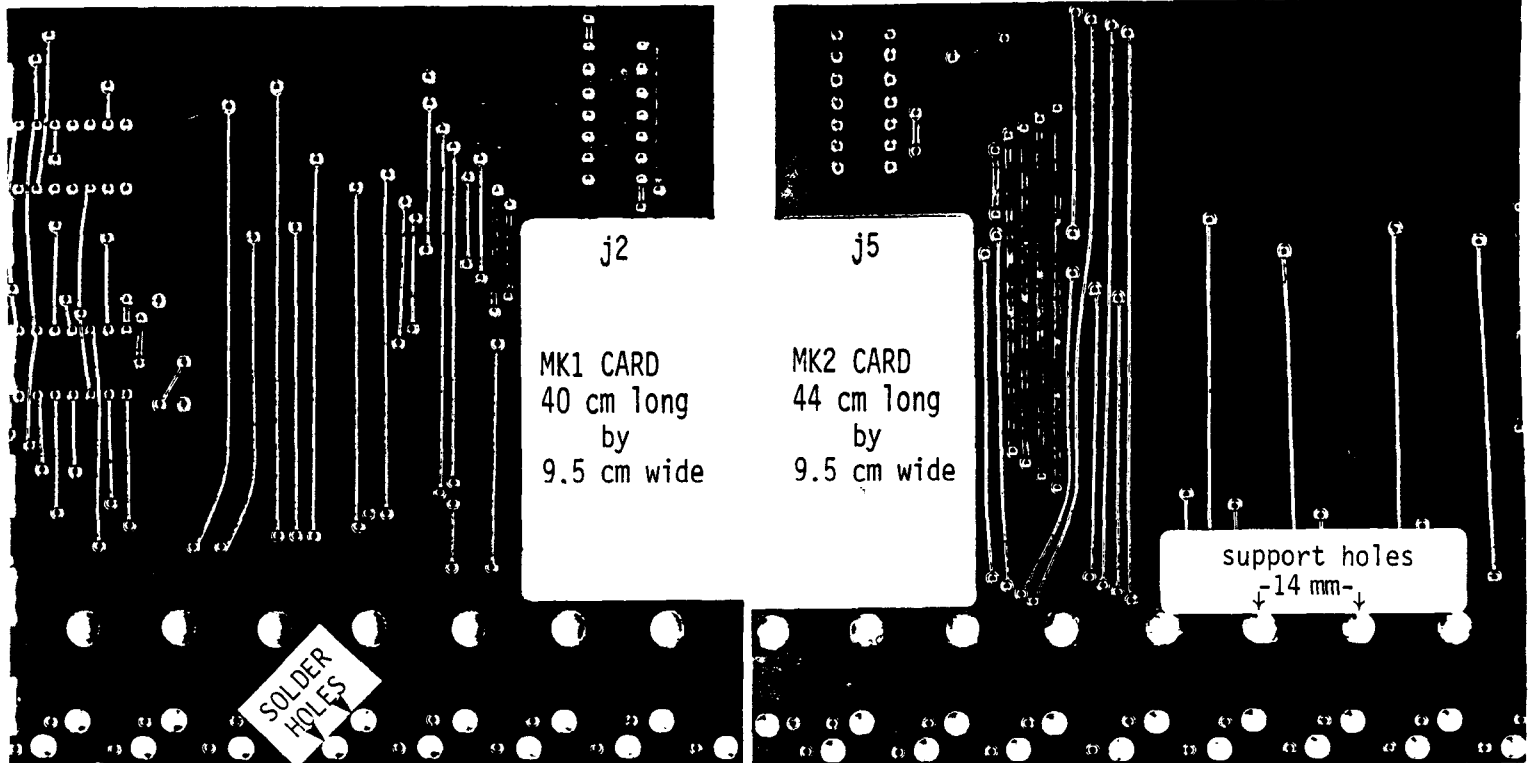

To FRONT of Keyboard

INSTALLATION of the MK1 @ MK2 cards to the two-bus, 61-key (5-octave) organ keyboard: The "pegs" of the keyboard fit thru the support holes of each card. Slip the 64 "solder leads" of the keyboard thru the 64 solder holes of MK2 & solder in place. Butt MK2 to MK1 as shown and solder the 58 "solder leads" to the 58 solder holes of MK1.

CABLES

- 1 - 5-7 cm length of 14-conductor flat ribbon cable with DIP sockets to connect j2 of MK1 to j5 of MK2
- 1 - 6 m length of 26-conductor flat ribbon cable with two AMP header connectors to connect j1 of MK1 to j1 of computer interface card. *Match pin 1 (white dot) of j1 of MK1 to j1 (white dot) of interface card
- 1 - 20 cm length of insulated wire from ground (gnd) of MK1 soldered to the chassis of the organ keyboard & the TWO keyboard bus lines

KEYBOARD: Pratt Read Co.
Model 10-0-1184-1-00
61-n c/c Keyboard
with switch

CASE: To suit



INSTRUMENT SYNTHESIZER COMPUTER INTERFACE CARD

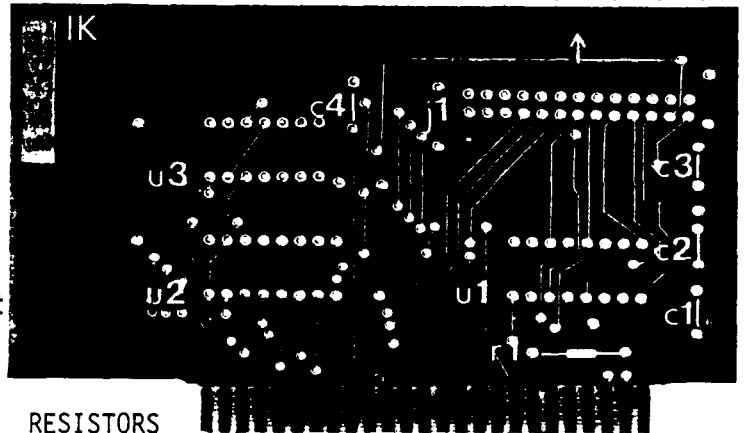

RESISTORS

- 1 - 1 K Ω @ r1

SOCKETS *pin 1: white dot

- 1 - 14-pin
- 2 - 16-pin

CAPACITORS

- 3 - 0.1 μ F Monolithic @ c2,3,4
- 1 - 10 μ F/16V Tantalum* @ c1

*Match + of capacitor with + on the layout

CONNECTOR

- 1 - 2x13 male header strip, 90 $^{\circ}$ @ j1

INTEGRATED CIRCUITS

- 1 - 74LS00 @ u3
- 2 - 74LS367 @ u1,2

GUIDE 8-10

TALKER I: Electronic speech synthesizer using the Votrax chip. Employs phoneme synthesis to allow user to construct an unlimited vocabulary by "pronouncing" in sequence the individual phonemes (simple sounds of spoken language). With power off, install in any slot except Ø. Requires software (one disk).

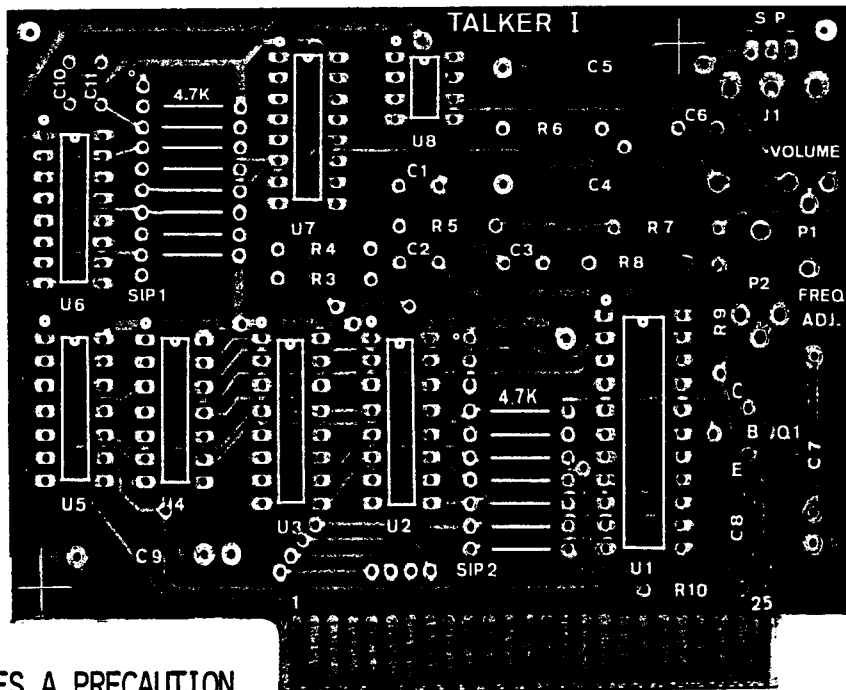

SEQUENCE *INDICATES A PRECAUTION

RESISTORS R 1/4 watt, 5%

- _____ 1 - 10 Ω @ R6
 - _____ 1 - 3.3 KΩ @ R5
 - _____ 2 - 4.7 KΩ @ R3,4
 - _____ 1 - 6.8 KΩ @ R8
 - _____ 1 - 10 KΩ @ R7
 - _____ 1 - 100 KΩ @ R10
 - _____ 2 - 10 KΩ Trimpot @ P1,2
 - _____ 2 - 4.7 KΩ 10-pin SIP* @ SIP 1,2
- *Position pin 1 of SIPs at o as shown on the layout
- _____ 1 - R9 trim, if required. (2.7 KΩ to 3.9 KΩ coarse frequency adjustment)

SOCKETS *Match pin 1 of sockets with pin 1 on the layout. Check that ALL pins have passed thru ALL holes

- _____ 1 - 8-pin
 - _____ 2 - 14-pin
 - _____ 4 - 16-pin
 - _____ 1 - 22-pin
- pin 1
upper left for
ALL sockets
and ICs
-

CONNECTORS

- _____ 1 - 2-pin Molex header @ SP or J1

TRANSISTOR Q *Position EBC leads correctly

- _____ 1 - 2N2222 @ Q1

CAPACITORS C

- _____ 1 - 150 pF @ C8
 - _____ 3 - 0.01 μF @ C3,10,11
 - _____ 3 - 0.1 μF Monolithic @ C1,2,6
 - _____ 2 - 10 μF/16V Tantalum* @ C7,9
 - _____ 2 - 220 μF/16V Axial* @ C4,5
- *Match + of electrolytic capacitors with + on layout

INTEGRATED CIRCUITS * Match pin 1 of ICs with pin 1 (o) on layout

- _____ 1 - SC-01A @ U1 Votrax
- _____ 2 - 74LS75 @ U2,3
- _____ 1 - 7416 @ U4
- _____ 1 - 74LS02 @ U5
- _____ 1 - 74LS123 @ U6
- _____ 1 - 74LS367 @ U7
- _____ 1 - LM 386 @ U8 audio amp (1 watt)

ADJUST:

- _____ P1 pot for loudness (VOLUME)
- _____ P2 pot for tone (FREQ. ADJ.)

SPEAKER

- _____ 1 - 8 Ohm

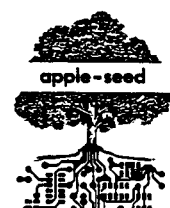

GUIDE 8-11

6850 MIDI CARD: Allows user to interface synthesizers, drum machines & other MIDI (Musical Instrument Device Interface) equipped musical instruments to the computer. Software required. Documentation available from supplier.

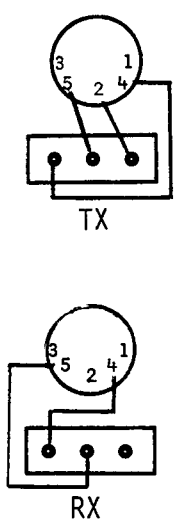
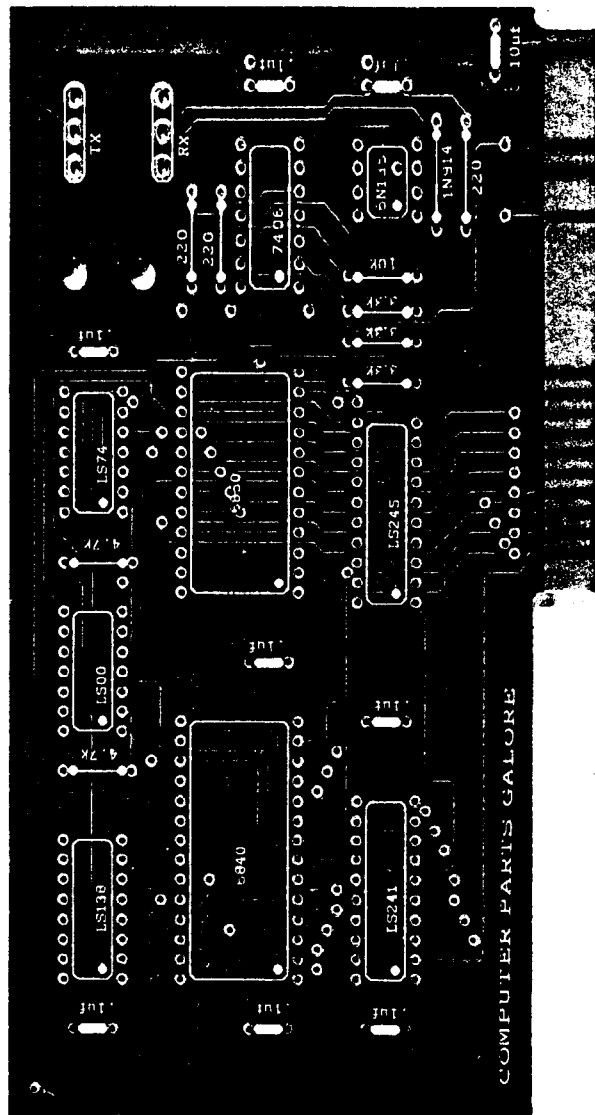
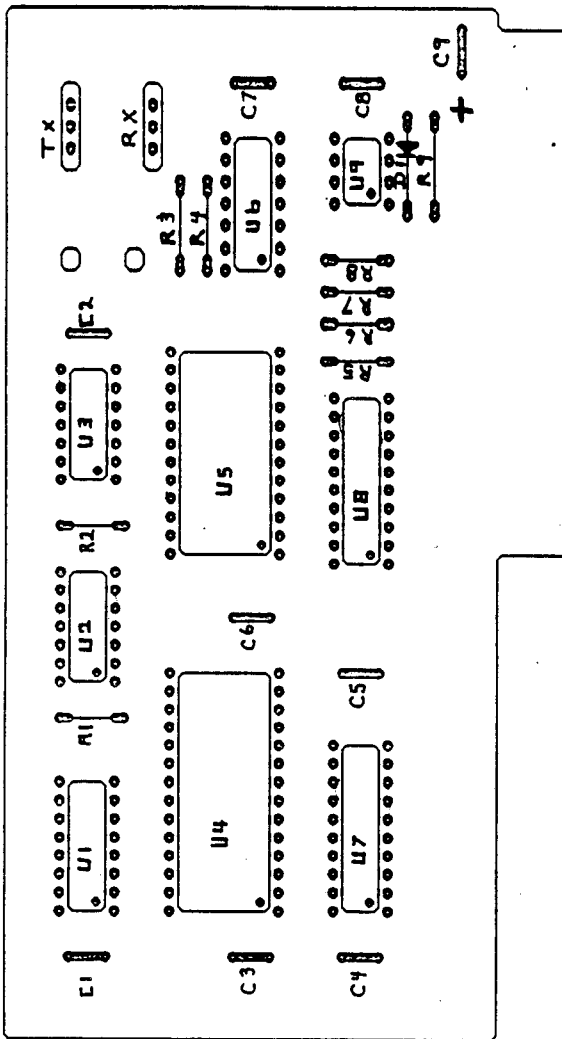

SEQUENCE *INDICATES A PRECAUTION

- RESISTORS R 1/4 watt, 5%
- _____ 3 - 220 Ω @ R3,4, _____ 1 22Ω @ R9
 - _____ 3 - 3.3 KΩ @ R5,6,7
 - _____ 2 - 4.7 KΩ @ R1,2
 - _____ 1 - 10 KΩ @ R8

- DIODES D *Position banded end of diode at arrow on the layout
- _____ 1 - 1N914* @ D1

- SOCKETS *Match pin 1 of sockets with pin 1 (white dot) on the layout. Check that ALL pins have passed thru ALL holes
- _____ 1 - 8-pin
 - _____ 3 - 14-pin
 - _____ 1 - 16-pin
 - _____ 2 - 20-pin

- CAPACITORS (continued)
- _____ 1 - 10 μF/16 V Tantalum* Match + of cap @ C9 with + on layout

- INTEGRATED CIRCUITS *Match pin 1 of ICs with pin 1 on the layout
- _____ 1 - 74LS00 @ U2
 - _____ 1 - 74LS74 @ U3
 - _____ 1 - 74LS138 @ U1
 - _____ 1 - 74LS241 @ U7
 - _____ 1 - 74LS245 @ U8
 - _____ 1 - 7406 @ U6
 - _____ 1 - 6N135 @ U9
 - _____ 1 - 6840 @ U4
 - _____ 1 - 6850 @ U5

CONNECTORS





PG DIGITAL SOUND SAMPLER: Allows user to digitally sample an audio input and to reproduce the sounds digitally thru externally connected speakers. With power off, install in any slot. Software available from supplier.

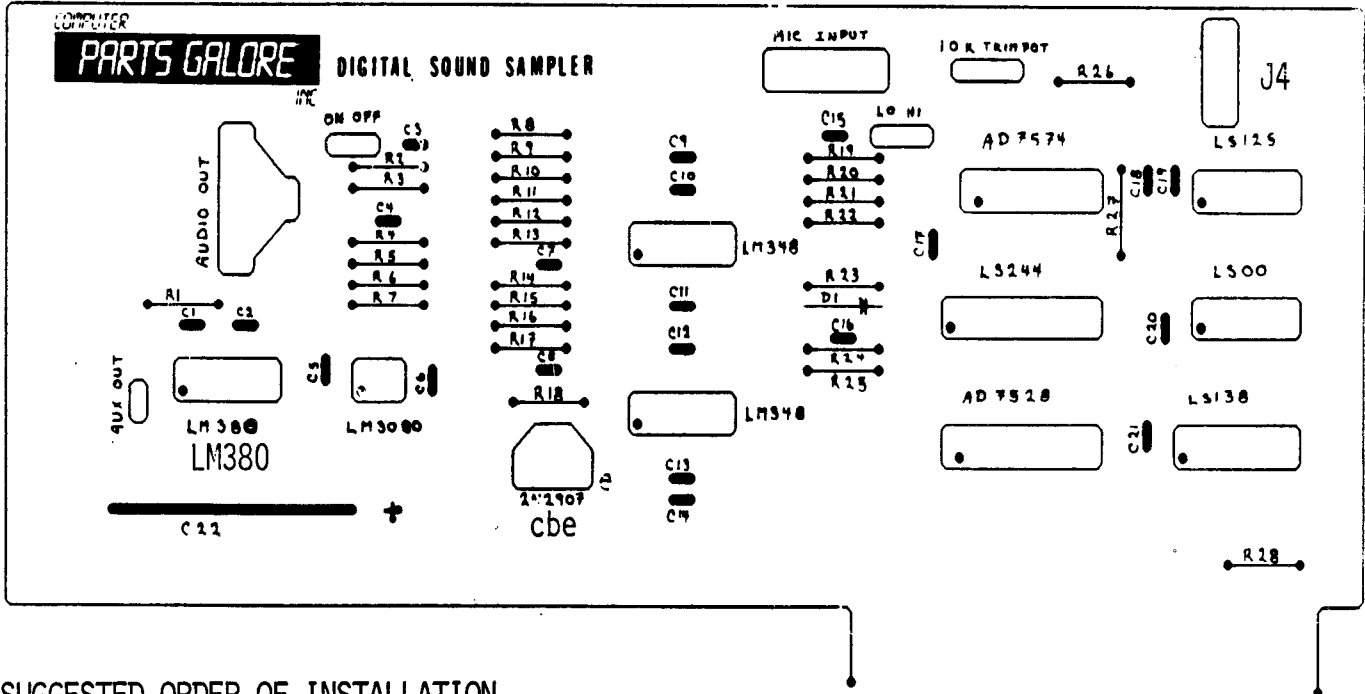

SUGGESTED ORDER OF INSTALLATION

*INDICATES A PRECAUTION

DIODES D *Position banded end (cathode) of diode towards the arrow
 ___ 1 - 1N914

RESISTORS R 1/4 watt 5%
 ___ 1 - 510 Ω @ R23
 ___ 7 - 1 KΩ @ R1,2,3,5,6,26,28
 ___ 1 - 5.1 KΩ @ R13
 ___ 1 - 6.8 KΩ @ R18
 ___ 6 - 10 KΩ @ R4,9,11,14,19,21
 ___ 4 - 100 KΩ @ R7,10,15,20
 ___ 1 - 180 KΩ @ R27
 ___ 1 - 220 KΩ @ R8
 ___ 2 - 330 KΩ @ R12,22
 ___ 2 - 5.1 KΩ metal oxide @ R16,17
 ___ 2 - 25.1 KΩ metal oxide @ R24,25
 ___ 1 - 10 KΩ Trimpot @ 10 K TRIMPOT controls input gain

SOCKETS *Match pin 1 of sockets with pin 1 (dot) on the layout. Check that ALL pins have passed thru ALL holes
 ___ 1 - 8-pin
 ___ 4 - 14-pin
 ___ 1 - 16-pin
 ___ 1 - 18-pin
 ___ 2 - 20-pin

CAPACITORS C *C17 is not equipped
 ___ 2 - 100 pF @ C4,18

CAPACITORS (continued)
 ___ 4 - 0.47 F @ C7,9,14,15
 ___ 1 - 470 F/50V Axial* @ C22 *Match + of axial with + on layout

TRANSISTOR Q *Match ebc leads of transistor with ebc on the layout
 ___ 1 - 2N2907

CONNECTORS
 ___ 1 - 2-pin male header @ AUX OUT provides a duplicate signal of the RCA audio output
 ___ 1 - 3-pin male header @ ON OFF controls a simple hi frequency filter for the output
 ___ 1 - 3-pin male header @ LO HI selects input sensitivity
 HI = 10 mV to 200 mV (P-P)
 LO = 200 mV to 4 volts (P-P)
 ___ 1 - 4-pin male header @ J4 to connect a feed back control pot for certain software. Not normally equipped
 ___ 1 - 3.5 female PC mount jack for MIC INPUT
 ___ 1 - RCA female PC mount jack for AUDIO OUT

INTEGRATED CIRCUITS *Match pin 1 of ICs with pin 1 on the layout
 ___ 1 - 74LS00
 ___ 1 - 74LS125
 ___ 1 - AD7574
 ___ 2 - LM348

GUIDE 8-13

ADVANCED 6850 MIDI CARD:(Ver 2): Allows user to interface synthesizers, drum machines & other MIDI (Musical Instrument Device Interface) equipped musical instruments to the computer. Requires software. Documentaion available from supplier.

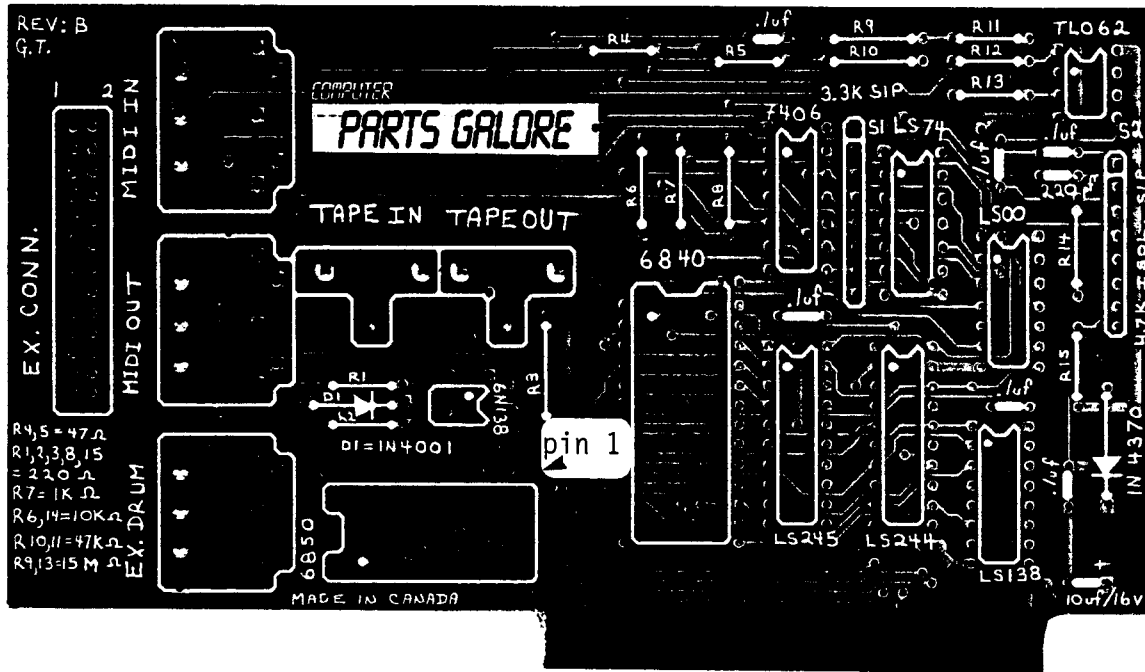

SEQUENCE *INDICATES A PRECAUTION

- DIODES D *Position banded end (cathode) of diode toward the arrow
- 1 - 1N4001 @ D1
 - 1 - 1N4370 2.4 V Zener diode/500 mV @ 1N4370

- RESISTORS R ½ watt, 5%
- 2 - 47 Ω @ R4,5
 - 5 - 220 Ω @ R1,2,3,8,15
 - 1 - 470 Ω @ R12
 - 1 - 1 KΩ @ R7
 - 2 - 10 KΩ @ R6,14
 - 2 - 47 KΩ @ R10,11
 - 2 - 15 MΩ @ R9,13

- *Match pin 1 of the following SIPs with pin 1 (white circle) on layout
- 1 - 3.3 KΩ 8-pin SIP* bussed @ S1
 - 1 - 47 KΩ 8-pin SIP* isolated @ S2 (*NOT 4.7 KΩ)

- SOCKETS *Match pin 1 of sockets with pin 1 on the layout. Check that ALL pins have passed thru ALL holes
- 2 - 8-pin
 - 3 - 14-pin
 - 1 - 16-pin
 - 2 - 20-pin
 - 1 - 24-pin* Note corrected pin 1
 - 1 - 28-pin

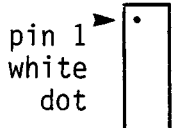

- CAPACITORS C
- 1 - 220 pF @ 220 pF
 - 6 - 0.1 μF Monolithic @ .1 μF
 - 1 - 10 μF/16V Tantalum* @ 10μF/16V

- CONNECTORS
- 2 - RCA female jacks, PCB mount @ TAPE IN, TAPE OUT
 - 3 - 5-pin DIN plugs, PCB mount @ EX. DRUM, MIDI OUT, MIDI IN
 - 1 - 2x13 header, right angle @ EX. CONN. (optional - use with external card in place of three 5-pin DIN plugs)

- INTEGRATED CIRCUITS *Match pin 1 of ICs with pin 1 on the layout
- 1 - 7406
 - 1 - 74LS00
 - 1 - 74LS74
 - 1 - 74LS138
 - 1 - 74LS244
 - 1 - 74LS245
 - 1 - 6850 ACIA *Note corrected pin 1
 - 1 - 6840 TIMER
 - 1 - TLO62 OP-AMP
 - 1 - 6N138 OPTO-ISOLATOR



GUIDE 9-1

COPY CARD: Allows you to make back-up copies of your protected software. With power off, install in any free slot except 0 or 6. Requires 16 K RAM card, firmware (one EPROM, and software (one disk).

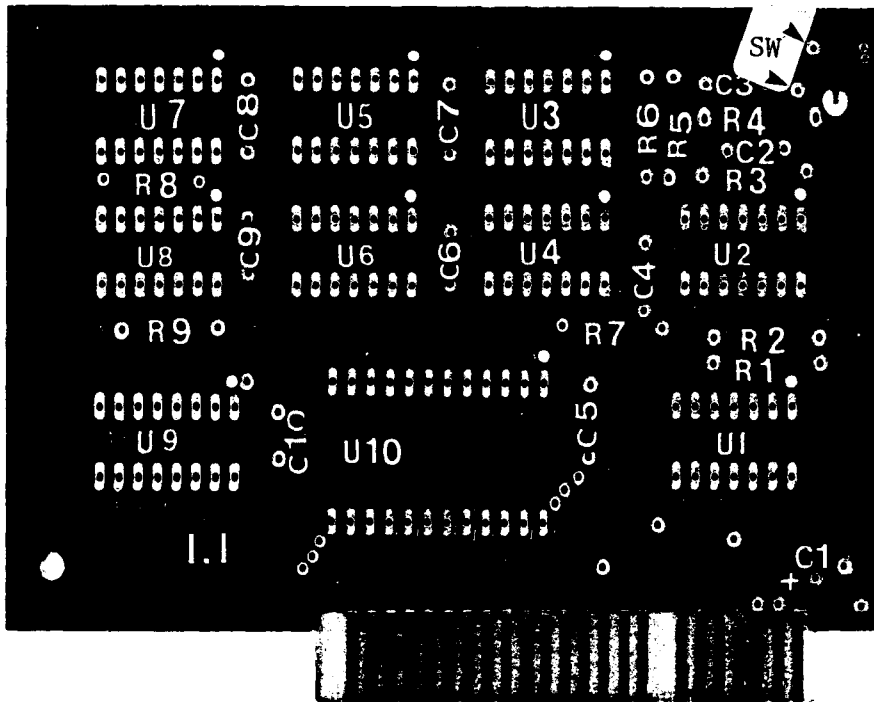

SEQUENCE *INDICATES A PRECAUTION

RESISTORS R $\frac{1}{4}$ watt, 5%

- _____ 7 - 6.8 K Ω @ R1,2,5,6,7,8,9
- _____ 2 - 100 Ω @ R3,4

CAPACITORS C

- _____ 8 - 0.1 μ F Monolithic @ C3 to C10
- _____ 1 - 270 pF 2% silver mica @ C2
- _____ 1 - 2.2 μ F/25v Tantalum* @ C1

*Match + of capacitor with
+ on layout

SOCKETS *Match pin 1 of socket with
pin 1 on layout. Check that ALL
pins have passed thru ALL holes.

- _____ 8 - 14-pin • ◀ pin 1
- _____ 1 - 16-pin
- _____ 1 - 24-pin

SWITCH AND CABLE

- _____ 1 - pushbutton switch, single pole
single throw (SPST)
- _____ 2 - 50-60 cm lengths of insulated
wire

SWITCH AND CABLE (continued)

Solder the two wires to the lugs of the
switch and cover with insulation.

Slip the other end of the wires thru
the large hole near R4. Tie a knot
about 1-2 cm from the end to act as a
"strain relief". Slip the leads thru
the solder holes and solder to the
solder side: i.e., Solder one lead to
ground and the other lead to the solder
pad connected to R4.

INTEGRATED CIRCUITS *Match pin 1 of IC
with pin 1 (white dot) on layout

- _____ 1 - 74LS00 @ U7
- _____ 1 - 74LS02 @ U8
- _____ 3 - 74LS05 @ U1,3,5
- _____ 1 - 74LS10 @ U2
- _____ 2 - 74LS30 @ U4,6
- _____ 1 - 74LS175 @ U9
- _____ 1 - 2716 EPROM @ U10



GUIDE 9-2

SNAPSHOT: Allows user to make backup copies of protected software. With power off, install in any slot except 0. Requires 64 K of RAM, firmware (one EPROM), and software (one disk).

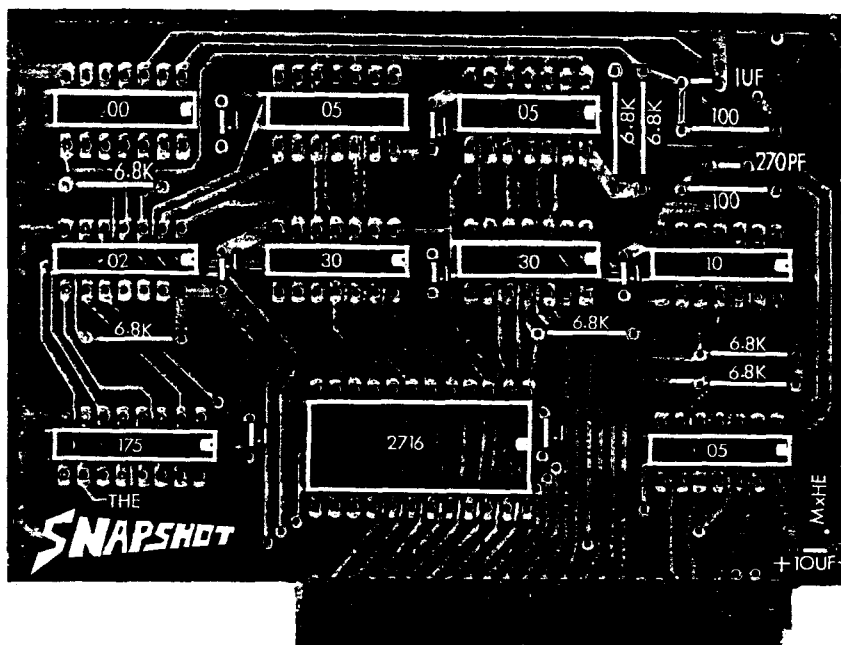

SEQUENCE *INDICATES A PRECAUTION

RESISTORS R ¼ watt, 5%

- 2 - 100 Ω
- 7 - 6.8 KΩ

SOCKETS *Match pin 1 of sockets with pin 1 on the layout. Check that ALL pins have passed thru ALL holes

- 8 - 14-pin
- 1 - 16-pin
- 1 - 24-pin

CAPACITORS C

- 1 - 270 pF
- 8 - 0.1 μF Monolithic @ positions labelled ".1"
- 1 - 10 μF/16v radial *Match + of capacitor with + on layout

SWITCH & CABLE

- 1 - pushbutton switch, SPST (single pole-single throw)
- 2 - 50-75 cm lengths of insulated wire

SWITCH & CABLE (continued)

Solder the ends of the two wires to the lugs of the switch and wrap with insulation. Pass the other end of each wire thru the holes of the component side as shown and solder them to the solder side.

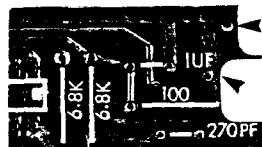

to switch

INTEGRATED CIRCUITS *Match pin 1 of ICs with pin 1 on the layout

- 1 - 74LS00
- 1 - 74LS02
- 3 - 74LS05
- 1 - 74LS10
- 2 - 74LS30
- 1 - 74LS175
- 1 - 2716 EPROM

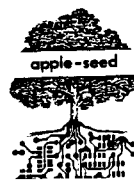
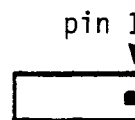

ROM BLASTER CARD: Allows user to read, write, or copy 2708-16-32 or 2508-16-32 EPROMS. With power off, insert in any slot except 0. Requires software (one disk).

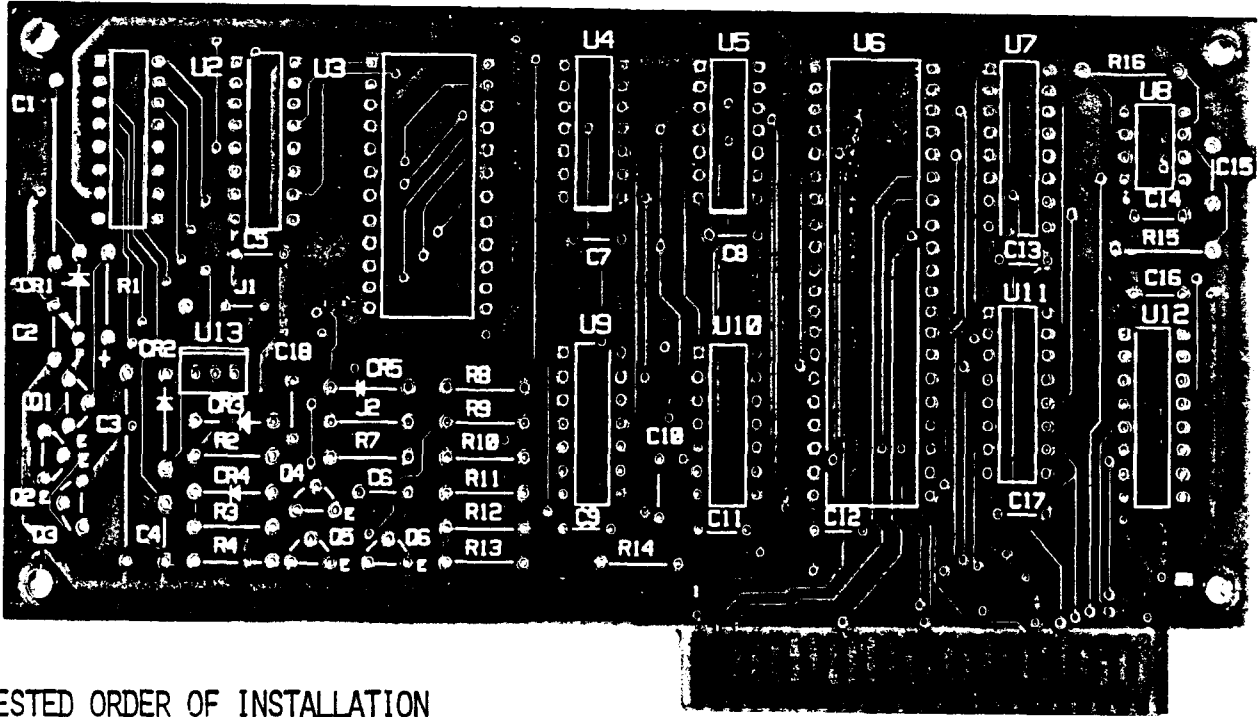

SUGGESTED ORDER OF INSTALLATION

*INDICATES A PRECAUTION

DIODES D *Postion banded end (cathode) of diode as shown
 cathode end

- 3 - 1N4001 @ CR1,2,4
- 1 - 1N754A 6.2 V Zener @ CR3
- 1 - 1N751A 5.1 V Zener @ CR5

RESISTORS R 1/2 watt, 5% *R5,6 is not silk-screened on the card

- 1 - 10 Ω @ R3
- 1 - 50 Ω @ R4
- 1 - 390 Ω @ R7
- 2 - 1 KΩ @ R1,15
- 1 - 2.2 KΩ @ R9
- 2 - 2.7 KΩ @ R10,11
- 1 - 6.8 KΩ @ R8
- 3 - 10 KΩ @ R2,12,13
- 1 - 47 KΩ @ R16
- 1 - 1.5 MΩ @ R14

JUMPER
 2 - @ J1,2

SOCKETS *Match pin 1 of sockets with pin 1 (square pad) on the layout. Check that ALL pins have passed thru ALL holes

SOCKETS (continued)

- 1 - 8-pin
- 4 - 14-pin
- 5 - 16-pin
- 1 - 40-pin
- - Personality Select Sockets
- 1 - EPROM Socket, Zero Insertion Force (ZIF)

CAPACITORS C

- 1 - 0.001 μF @ C15
- 15 - 0.1 μF @ C2,4,5,6,7,8,9,10,11,12,13,14,16,17,18
- 2 - 22 μF/63v Axial* @ C1,3

*Match + of capacitors with + on the layout

TRANSISTORS Q *Match the three EBC transistor leads correctly

- 3 - 2N5550 or 2N5551 @ Q1,2,3
- 2 - 2N2907 @ Q4,5
- 1 - 2N2222A @ Q6



*Only E is silk-screened on the layout
 (continued)



ROM BLASTER CARD (continued)

INTEGRATED CIRCUITS *Match pin 1 of ICs with pin 1 (white dot) on the layout.
Refer to SOCKETS for U1 & U3

- _____ 1 - CD4040B @ U2 12-stage binary/ripple counter
- _____ 1 - 74LS02 @ U4
- _____ 1 - 74LS04 @ U5
- _____ 1 - one of
6820 or)
6821 or) @ U6 Peripheral Interface Adapter (PIA)
6521)
- _____ 3 - 74LS367 @ U7,11,12
- _____ 1 - NE555 @ U8 Timer
- _____ 1 - 7407 @ U9 Hex inverter buffer/driver
- _____ 1 - 74LS00 @ U10
- _____ 1 - 7820 @ U13 20 V voltage regulator*

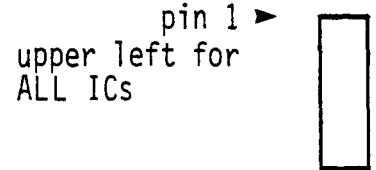

*Position metal (heat sink) of voltage regulator along the double bar on the layout

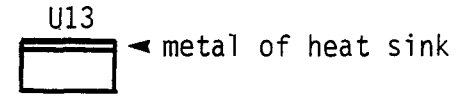

PERSONALITY SELECT SOCKETS: plug-in adapters (16-pin component carriers strapped as shown) are used to reconfigure the programming socket to match the type of EPROM being programmed.

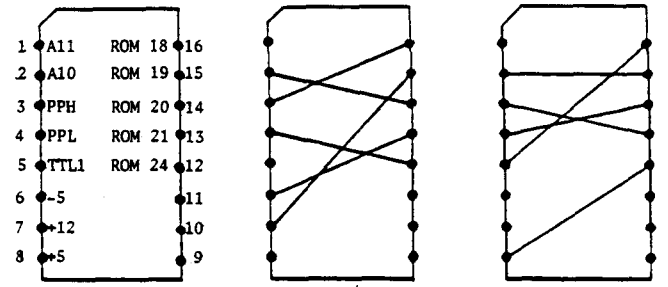

SIGNALS

2716
3-voltage

2716
5-volt only

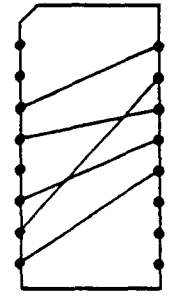

2708

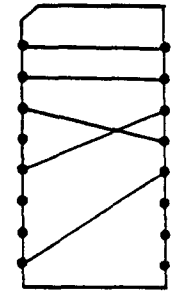

2532

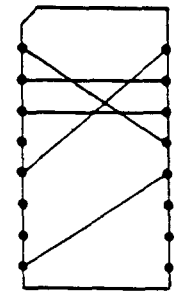

2732

Use diodes as shown when programming 2732A or 2815/2816 EPROMS:

- _____ 2 - 1N5231 5.1V Zeners
- _____ 1 - 1N4001

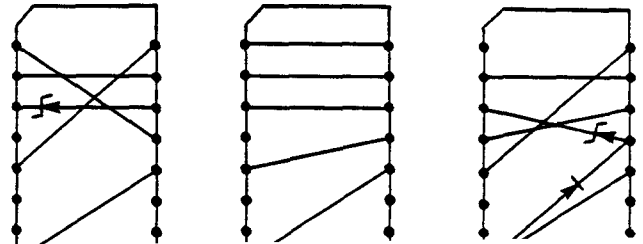

EPROM PROGRAMMER: Allows user to read, write or copy 2708,16,32,64 and 2532,64. With power off, install in any slot between 1 & 5. Requires firmware (one EPROM).

*NOTE THE COMPONENT CHANGES

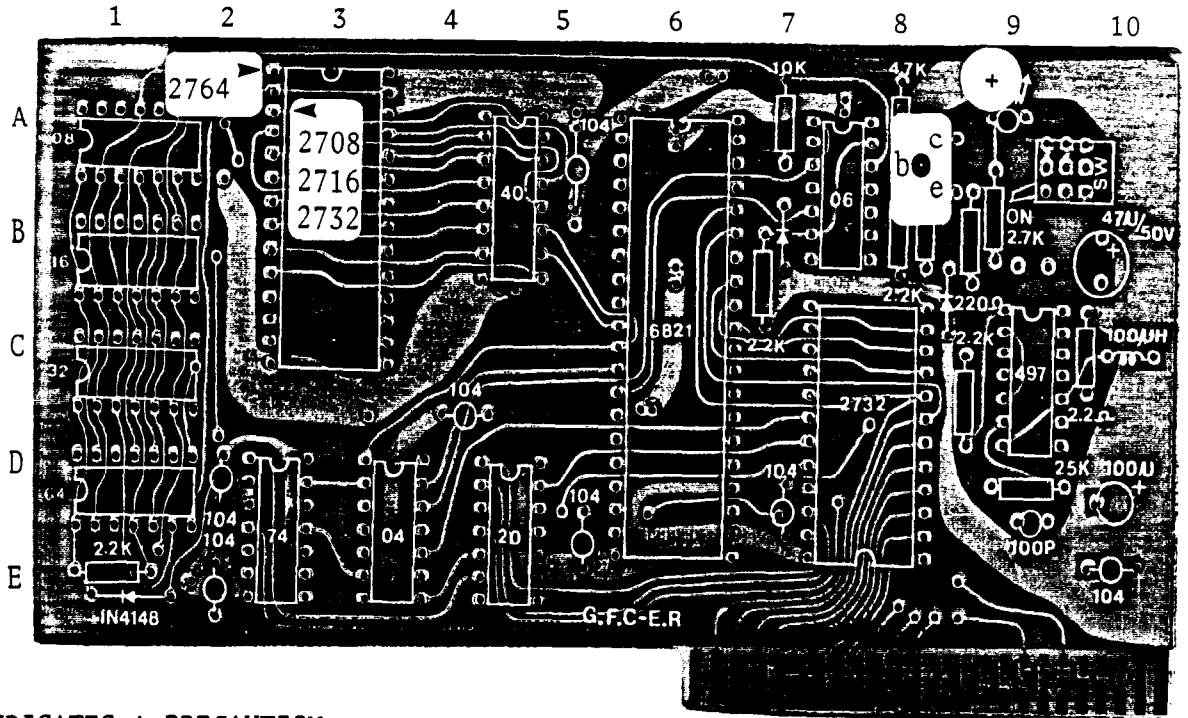

SEQUENCE *INDICATES A PRECAUTION

DIODES D *Position banded end (cathode) of diode as shown

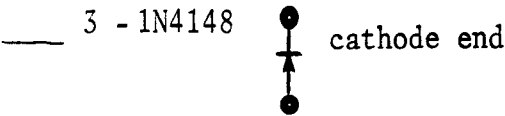

1 - LED *Position longer lead (+) of LED as shown on the layout @ A-9

RESISTORS 1/4 watt, 5% (unless indicated)

- 1 - 10 KΩ @ A7
- 1 - 4.7 KΩ @ A8
- 1 - 2.2 KΩ @ B8
- 1 - 100 Ω @ B8-9 in place of 1 KΩ
- 1 - 22 Ω @ B8-9 in place of 220 Ω
- 1 - 4.7 KΩ @ B9 in place of 2.7 kΩ
- 1 - 2.2 KΩ @ B-C7
- 1 - 1.0 Ω, 1/2W @ C10 in place of 2.2 Ω
- 1 - 1 KΩ @ C-D9 in place of 2.2 KΩ
- 1 - 22 KΩ, 1/2W @ D9 in place of 25 KΩ
- 1 - 2.2 KΩ @ E1

INDUCTOR L

- 1 - 100 uH RF choke

SOCKETS *Match pin 1 of sockets with pin 1 on the layout. Check that ALL pins have passed thru ALL holes

- 9 - 14-pin
- 1 - 16-pin
- 1 - 24-pin

CAPACITORS C

- 1 - 100 pF
 - 5 - 0.1 uF Monolithic *delete 2 caps at A-B5 & E2
 - 1 - 22 uF/16v Tantalum* @ D10
 - 1 - 33 uF/16v Radial* @ B10
- *Match + of capacitors with + on layout

INTEGRATED CIRCUITS *Match pin 1 of IC with pin 1 on layout

- 1 - 74LS04
- 1 - 74LS20
- 1 - 74LS74
- 1 - CD4040
- 1 - TL497
- 1 - 7406
- 1 - 6821P
- 1 - 2716 EPROM

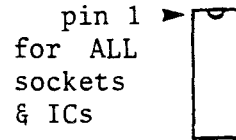

TRANSISTOR Q

- 1 - 2N3904 *Install the EBC leads as shown on the layout

SWITCH

- 1 - SPST PCB mount @ SW

(continued)



EPROM PROGRAMMER (continued)

PERSONALITY SELECT SOCKETS

Plug-in adapters (14-pin component carriers strapped as shown) are used to reconfigure the programming sockets (labelled on the layout) to match the type of EPROM being programmed.

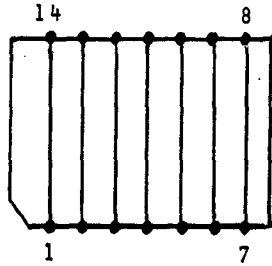

standard 2708
EPROMS 2716
2732
2764

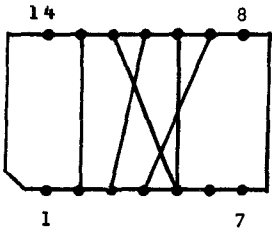

non standard 2532
EPROM

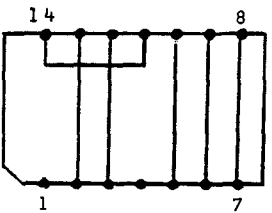

non standard 2564
EPROM

EPROM PROGRAMMER: The component side of this card is NOT silk-screened. Refer to the Guide on the previous page for component placement.

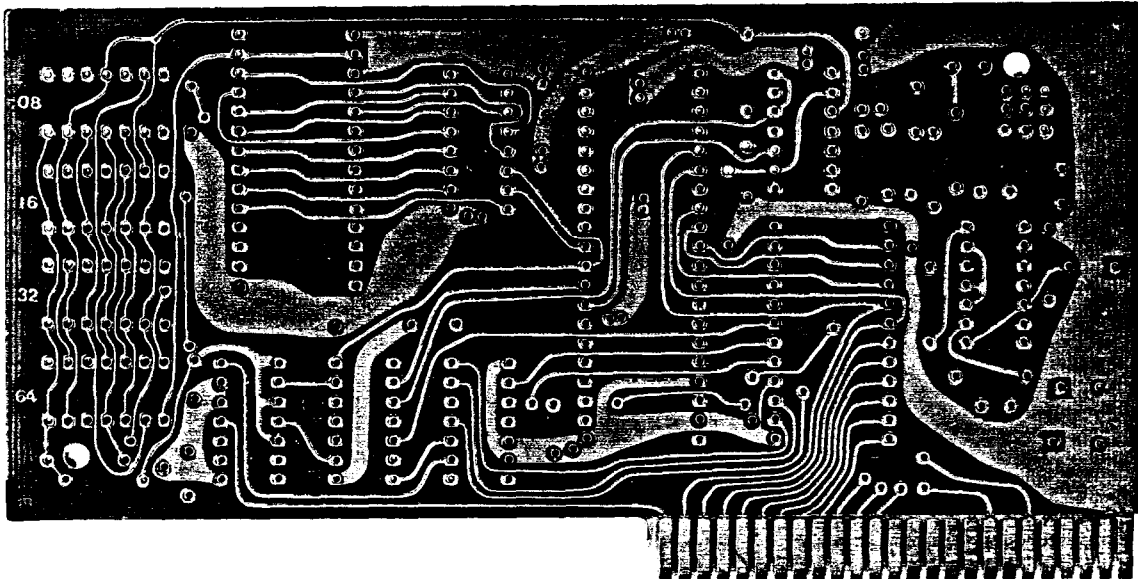

GUIDE 9-5

AP-64 EPROM WRITER: Burns 2716-32-64 EPROMS. Functions include: write, read, copy, verify, blank check, monitor. Requires firmware (one EPROM) and documentation.

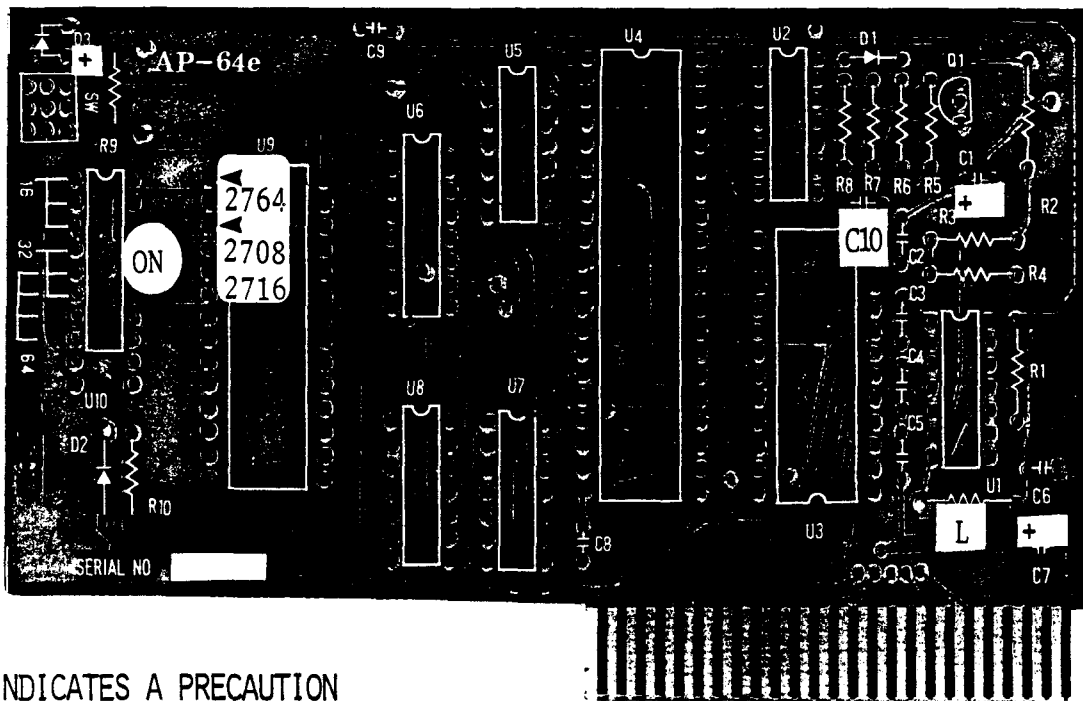

SEQUENCE *INDICATES A PRECAUTION

DIODES D *Position banded end (cathode) of diode as shown

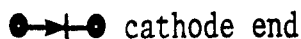

2 - 1N4001 @ D1,2

1 - LED *Position longer lead(+) as shown on the layout @ D3

RESISTORS R 1/4 watt, 5%

1 - 1 Ω @ R1

1 - 27 Ω @ R7

1 - 100 Ω @ R10

1 - 120 Ω @ R6

1 - 680 Ω @ R4

3 - 4.7 KΩ @ R5,8,9

1 - 10 KΩ @ R3

1 - 5 KΩ 2-cm rectangular trimpot, multi-turn adjustment @ R2

INDUCTOR L

1 - 100 μH @ L

SOCKETS *Match pin 1 of sockets with pin 1 on the layout. Check that ALL pins have passed thru ALL holes

5 - 14-pin

1 - 16-pin

1 - 24-pin

1 - 40-pin

1 - 28-pin ZIF (Zero-Insertion Force)

CAPACITORS C

1 - 100 pF disc ceramic @ C4

7 - 0.1 μF Tantalum @ C2,3,5,7,8, C9,10

CAPACITORS (continued)

1 - 2.2 μF/25V Radial* @ C1

1 - 10 μF/16V Radial* @ C6

*Match + of Radials with + on the layout

TRANSISTOR Q *Position the EBC leads as shown

1 - 2N3904 @ Q1

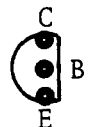

SWITCHES

1 - SPST @ SW *up position for "on"

1 - 8-position DIP @ U10, select as shown:

2716 - 1,2,3 on

2732 - 4,5,6 on

2764 - 5,6,7,8 on

INTEGRATED CIRCUITS *Match pin 1 of ICs with pin 1 on the layout

1 - 74LS04 @ U5

1 - 74LS20 @ U7

1 - 74LS74 @ U8

1 - CD4040 @ U6

1 - TL497 @ U1

1 - 7406 @ U2

1 - 6821P @ U4

1 - 2716 EPROM @ U3

pin 1 for all sockets and ICs



NOTE: Adjust trimpot @ R2 for correct voltage as outlined in the documentation

GUIDE 9-6

SUPER BURNER: Read, program any standard single-voltage EPROM including 27---- series 08, 16, 32, 32A, 64, 64A, 128, 128A, 256, 512 at either fast or normal burn speeds. With power off, install in any slot. Requires software (one diskette).

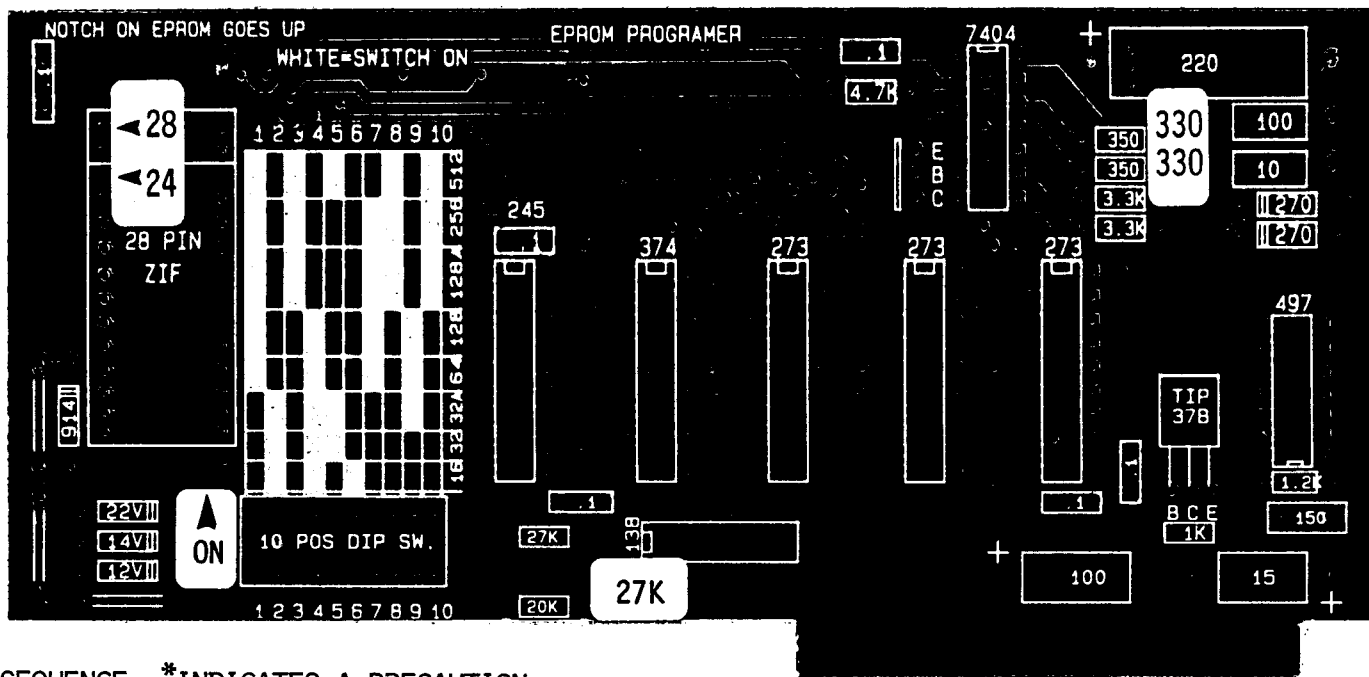

SEQUENCE *INDICATES A PRECAUTION

DIODES D *Position banded end (cathode) of diode as shown

- ___ 2 - 1N270 @ 270
- ___ 1 - 1N914 @ 914
- ___ 1 - 12V 500 mw Zener @ 12V
- ___ 1 - 14V 500 mw Zener @ 14V
- ___ 1 - 22V 500 mw Zener @ 22V

RESISTORS R ½ watt, 5% *Except 9.1 Ω

- ___ 1 - 9.1 Ω @ 10 *½ watt, 5%
- ___ 2 - 330 Ω @ 350
- ___ 1 - 1 KΩ @ 1K
- ___ 1 - 1.2 KΩ @ 1.2K
- ___ 2 - 3.3 KΩ @ 3.3K
- ___ 1 - 4.7 KΩ @ 4.7K
- ___ 2 - 27 KΩ @ 20K & 27K

COIL (RF CHOKE) L
___ 1 - 100 μH @ 100

SOCKETS *Match pin 1 of sockets with pin 1 on the layout. Check that ALL pins have passed thru ALL holes

- ___ 2 - 14-pin
- ___ 1 - 16-pin
- ___ 5 - 20-pin
- ___ 1 - 28-pin ZIF (Zero Insertion Force)

TRANSISTORS Q *Match EBC leads of transistors with EBC on the layout

- ___ 1 - 2N3904 @ Q1
- ___ 1 - TIP37B @ Q2

CAPACITORS C

- ___ 1 - 150 pF @ 150
- ___ 6 - 0.1 μF Monolithic @ .1
- *Match + of the following AXIAL capacitors with + on the layout
- ___ 1 - 15 μF/25V axial* @ 15
- ___ 1 - 100 μF/16V axial* @ 100
- ___ 1 - 220 μF/50V axial* @ 220

SWITCH *Note "ON" position

- ___ 1 - 10-position DIP for EPROM select

INTEGRATED CIRCUITS *Match pin 1 of ICs with pin 1 on the layout

- ___ 1 - 74LS07 @ 7404
- ___ 1 - 74LS138
- ___ 1 - 74LS245
- ___ 3 - 74LS273
- ___ 1 - 74LS374
- ___ 1 - TL497ACN

SWITCH SETTINGS Set DIP switches ON according to the chart on the layout

- e.g. For 2716 set # 2,4,6 ON
- THE FOLLOWING ARE NOT SHOWN ON THE CHART:
- For 2708 set #2,4,6 ON (as for 2716)
- For 2764A set #1,4,7,8 on
- For Toshiba 27256 set #1,3,7,9 ON

Jumpers:

- ___ 3 - strap @ ●—●



EXCEL BURNER: Allows user to read, write, copy 2716, 1732, 2732A & 2764 EPROMs. With power off, install in any slot. Requires software (one diskette).

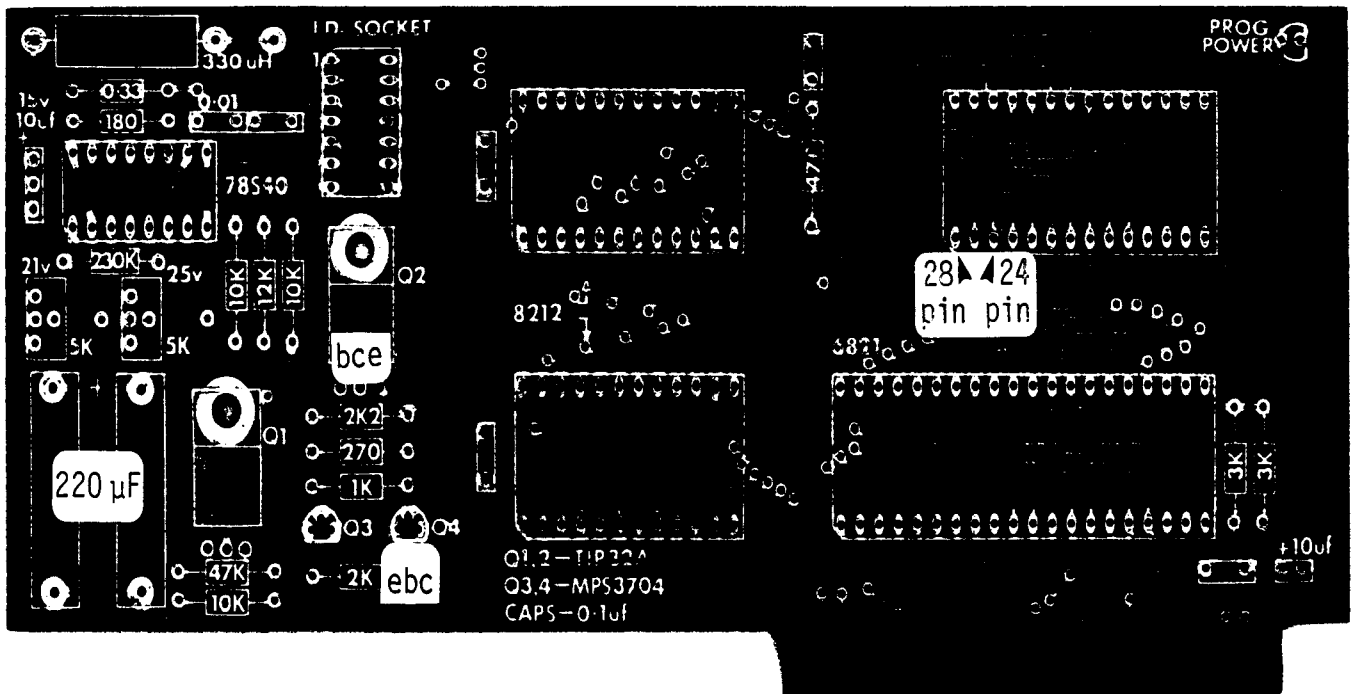

SUGGESTED SEQUENCE *INDICATES A PRECAUTION

- RESISTORS R ¼ watt, 5%
- _____ 1 - 0.33 Ω *2 watt
 - _____ 1 - 180 Ω
 - _____ 1 - 270 Ω
 - _____ 1 - 470 Ω
 - _____ 1 - 1 KΩ
 - _____ 1 - 2 KΩ
 - _____ 1 - 2.2 KΩ
 - _____ 2 - 3 KΩ
 - _____ 3 - 10 KΩ
 - _____ 1 - 12 KΩ
 - _____ 1 - 47 KΩ
 - _____ 1 - 230 KΩ
 - _____ 2 - 5 KΩ Tripot

- TRANSISTORS Q *Match ebc leads of transistors with ebc on the layout
- _____ 2 - MPS3704 @ Q1
 - _____ 2 - TIP32A @ Q1,2 Secure the top of the TIP32A transistors to the card with two nuts and bolts

- INTEGRATED CIRCUITS *Match pin 1 of ICs with pin 1 on the layout
- _____ 1 - UA78S40
 - _____ 2 - 8212
 - _____ 1 - 6821

- LIGHT EMITTING DIODE
- _____ 1 - LED @ PROG POWER

- SOCKETS *Match pin 1 of sockets with pin 1 on the layout. Check that ALL pins have passed thru ALL holes
- _____ 1 - 14-pin
 - _____ 1 - 16-pin
 - _____ 2 - 24-pin
 - _____ 1 - 40-pin
 - _____ 1 - 28-pin ZIF (Zero-Insertion Force)

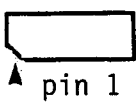

- INDUCTOR L
- _____ 1 - 330 μH

- CAPACITORS C
- _____ 1 - 0.01 μF
 - _____ 4 - 0.1 μF Monolithic @
- *Match + of the following capacitors with + on the layout
- _____ 2 - 10 μF/16V Tantalum*
 - _____ 2 - 220 μF/25V Axial* @ 220 μF

NuScope Associates



GUIDE 10-1

RGB CARD: Allows the user to interface an RGB colour monitor to the computer. With power off, install in slot number 7.

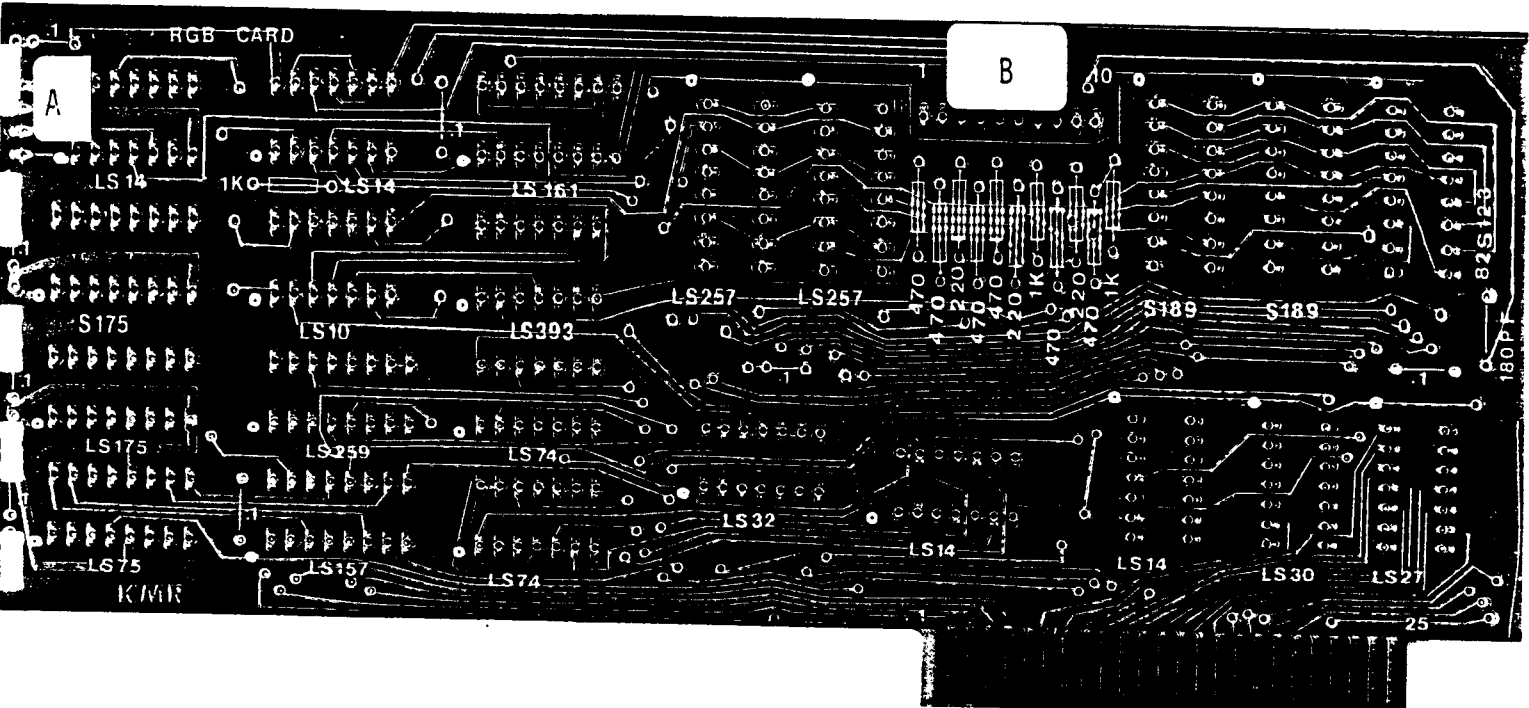

SUGGESTED ORDER OF INSTALLATION

*INDICATES A PRECAUTION

RESISTORS: R ¼ watt, 5%

- 3 - 220 Ω
- 5 - 470 Ω
- 3 - 1 KΩ

CAPACITORS: C

- 8 - 0.1 μF Monolithic
- 1 - 180 pF Disc

SOCKETS: *Match pin 1 of sockets with pin 1 (white dot) on the layout. Check that ALL pins have passed thru ALL holes

- 11 - 14-pin
- 11 - 16-pin

CONNECTORS:

- 1 - 1x4 male header strip, right-angle @ A on the layout for input from motherboard
- 1 - 1x10 male header strip, straight @ B on the layout for output to RGB monitor

Refer to appropriate user manual for correct interfacing

INTEGRATED CIRCUITS: *Match pin 1 of IC with pin 1 (white dot) on layout

- 1 - 74LS10
- 4 - 74LS14
- 1 - 74LS27
- 1 - 74LS30
- 1 - 74LS32
- 2 - 74LS74
- 1 - 74LS75
- 1 - 74LS157
- 1 - 74LS161
- 1 - 74LS175
- 2 - 74LS257
- 1 - 74LS259
- 1 - 74LS393
- 1 - 74S175
- 2 - 74S189
- 1 - 82S123 PROM

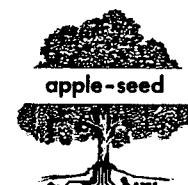
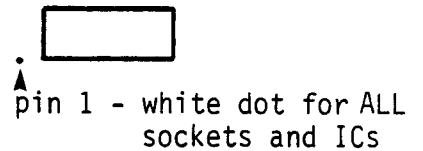

GUIDE 10-2

TIME CARD: Real time clock/calendar with on board battery backup power, charges when the computer is on. With power off, install in any slot except 0 (slot 5 recommended). Requires software (one disk).

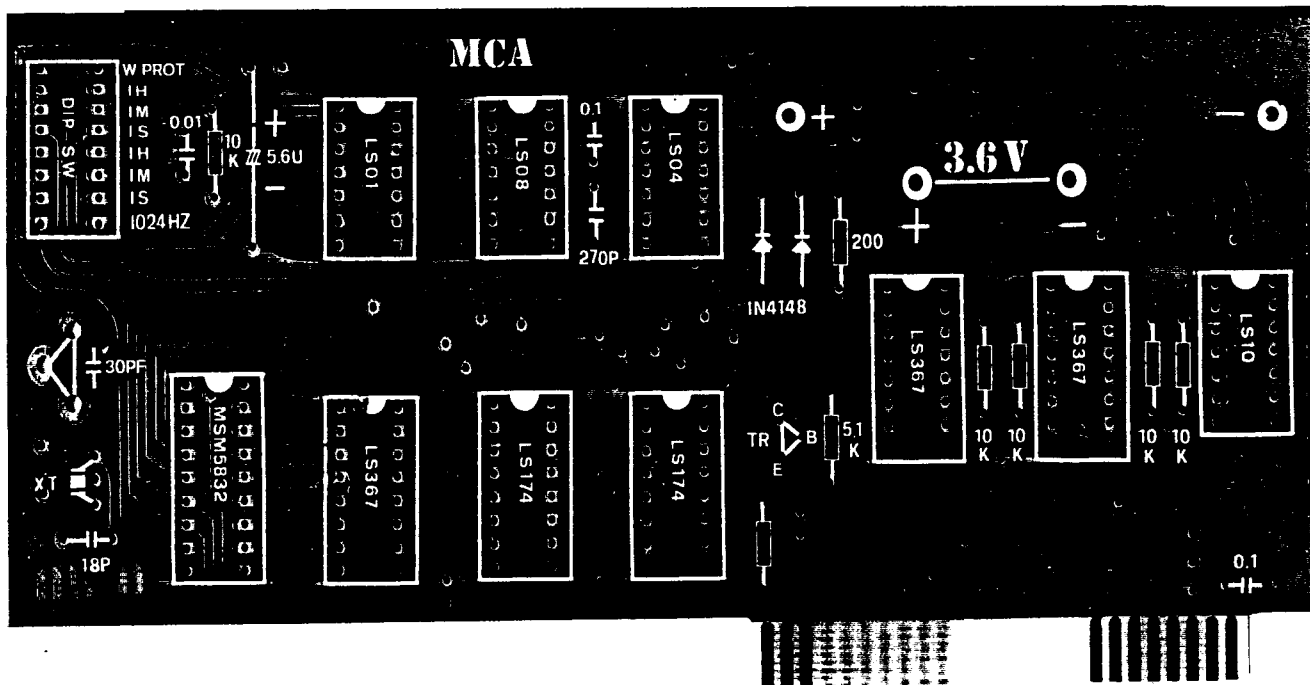

SEQUENCE *INDICATES A PRECAUTION

DIODES D *Position banded end (cathode) of diode as shown

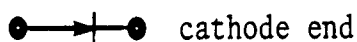

___ 2 - 1N4148

RESISTORS R 1/2 watt, 5%

- ___ 1 - 200 Ω
- ___ 1 - 5.1 Ω
- ___ 5 - 10 KΩ
- ___ 1 - 680 Ω @ position unlabelled

SOCKETS *Match pin 1 of sockets with pin 1 on the layout. Check that ALL pins have passed thru ALL holes

- ___ 4 - 14-pin
- ___ 5 - 16-pin
- ___ 1 - 18-pin

CAPACITORS C

- ___ 1 - 18 pF
- ___ 1 - 270 pF
- ___ 1 - 0.01 μF
- ___ 2 - 0.1 μF
- ___ 1 - 30 pF variable capacitor
- ___ 1 - 5.6 μF/16v axial*

*Match + of capacitor with + on the layout

TRANSISTOR Q *Install the three EBC transistor leads correctly

- ___ 1 - 2N3904 @ TR

CRYSTAL Y

- ___ 1 - 32.708 KHz @ XT on DIP S.W. off

SWITCH

- ___ 1 - 8-position DIP S.W. DIP S.W.

BATTERY

- ___ 1 - 3.6V NiCad rechargeable appropriately mounted

INTEGRATED CIRCUITS *Match pin 1 of IC with pin 1 on layout

- ___ 1 - 74LS01
 - ___ 1 - 74LS04
 - ___ 1 - 74LS08
 - ___ 1 - 74LS10
 - ___ 2 - 74LS174
 - ___ 3 - 74LS367
 - ___ 1 - MSM5832 real time clock/calender (OKI)
- pin 1 
- upper left for ALL sockets and ICs



NuScope Associates

GUIDE 10-3

INPUT/OUTPUT CARD: Universal interface card with prototyping area for custom design. Install either Peripheral Interface Adapter MPU or Programmable Interface Adapter MPU.

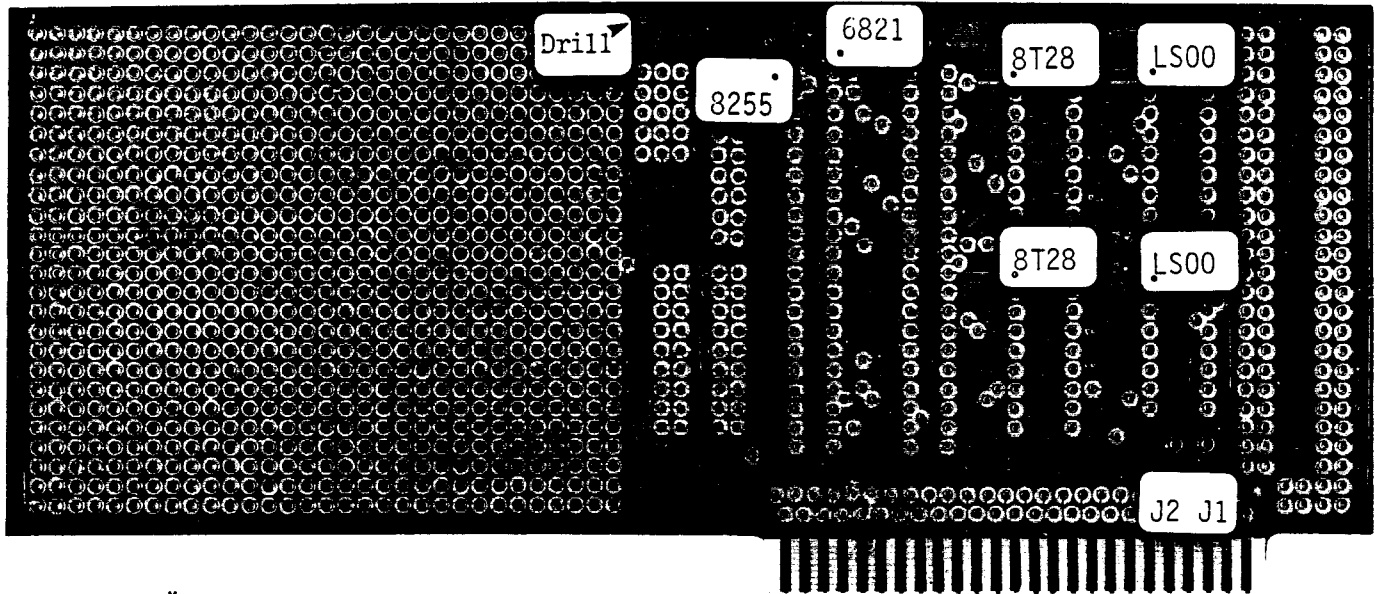

SEQUENCE *INDICATES A PRECAUTION

SOCKETS *Match pin 1 of sockets with pin 1 (dot) on the layout. Check that ALL pins have passed thru ALL holes

- ___ 2 - 14-pin
- ___ 2 - 16-pin
- ___ 1 - 40-pin

CONNECTORS

- ___ 2 - 2-pin male header, straight @ J1,2

INTEGRATED CIRCUITS *Match pin 1 of ICs with pin 1 on the layout

- ___ 2 - 74LS00 quad 2 input NAND gate
- ___ 2 - 8T28 quad tri-state bus transeiver

ONE OF THE FOLLOWING:

- ___ 1 - 6821 Peripheral Interface Adapter
*Note pin 1 position

OR

- ___ 1 - 8255 Programmable Interface Adapter
*Note pin 1 position

MODIFICATION: If necessary, drill the feed-thru hole labelled "Drill" on the layout to prevent a short between GND & +5V

NuScope Associates

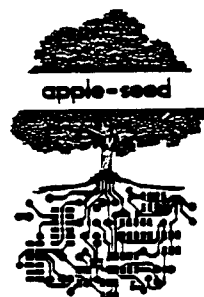

MULTIFUNCTION CARD: Provides an interface between the computer & external support devices including a bi-directional serial port, a parallel output interface, & a real-time clock/calender. With power off, install in any slot except 0. Requires firmware (one EPROM), software (one disk), & documentation.

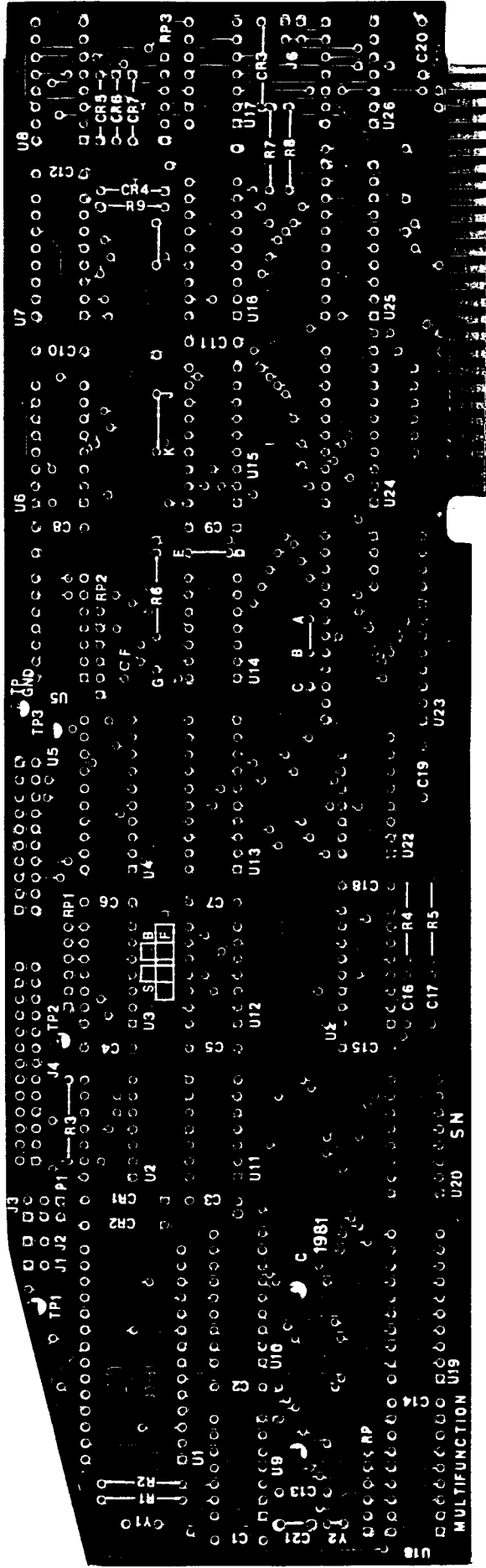

SEQUENCE * INDICATES A PRECAUTION

DIODES D *Position banded end (cathode) of diodes towards the "square" pad
 6 - 1N4148 @ CR1,2,3,4,5,6

- RESISTORS R** ¼ watt, 5%
- 1 - 51 Ω @ CR7*NOT an R number
 - 1 - 100 Ω @ R3
 - 1 - 510 Ω @ R9
 - 1 - 620 Ω @ R6
 - 2 - 1 KΩ @ R7,8
 - 2 - 1.5 KΩ @ R1,2
 - 1 - 10 KΩ @ R4
 - 1 - 20 KΩ @ R5
 - 2 - 10 K SIP* @ RP1,4
 - 1 - 1 K SIP* @ RP2
 - 1 - 10 K SIP* @ RP3

*Match pin 1 of SIPs with "square" solder pad (GND)

COMPONENT SIDE

SOCKETS *Match pin 1 of sockets with pin 1 (square pad) on the layout. Check that ALL pins pass thru ALL holes

- 10 - 14-pin
 - 6 - 16-pin
 - 3 - 18-pin
 - 5 - 20-pin
 - 2 - 40-pin
- pin 1 lower left for ALL sockets

CAPACITORS C

- 1 - 10 pF/100V Mica @ C13
- 1 - 100 pF/500V Mica @ C16,17
- 17 - 0.1 μF Monolithic @ C1,2,3,4,5,6, C7,8,9,10,11,12,14,15,18,19,20
- 1 - 0-50 pF Trimcap @ C21

CONNECTORS

- 4 - terminal posts @ TP1,2,3,TP-GND

CONNECTORS (Cont) Headers are straight

- 1 - 2x13 male header strip @ J4
- 1 - 2x10 male header strip @ J5*
- *J5 is silk-screened "U5"
- 1 - 14-pin male header: Use as 2-pin connectors @ J1,2,3,6, & @ the 4 squares between S&B

CRYSTAL Y

- 1 - 32.768 KHz (CLOCK) @ Y2
- 1 - 5.0688 MHz (UART) @ Y1

BATTERY

- 2 - 1.5 alkaline (AA) @ P1*

Mount battery with appropriate holder on solder side & secure with ties

+ve red
 J2 ● P1*
 -ve black

(Continued)



MULTIFUNCTION CARD (Continued)

FLAT RIBBON CABLES

- 1 - serial, 26-conductor to 25-pin "D" connector
- 1 - parallel, 20-conductor to 36-pin "Centronics" style connector

INTEGRATED CIRCUITS *Match pin 1 of ICs with pin 1 on the layout

- 1 - 74LS03 @ U5
- 1 - 74LS04 @ U9
- 1 - 74LS08 @ U17
- 1 - 74LS09 @ U14
- 2 - 74LS32 @ U22, 26
- 1 - 74LS74 @ U12
- 1 - 74LS123 @ U21
- 1 - 74LS136 @ U3
- 2 - 74LS138 @ U6, 7
- 1 - 74LS155 @ U8
- 1 - 74LS173 @ U18
- 2 - 74LS273 @ U13, 19
- 1 - 74LS357 (T.I.) @ U25
- 1 - 74LS367 @ U20
- 1 - 74LS374 @ U4

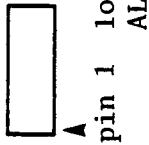

INTEGRATED CIRCUITS (Continued)

- 1 - 2716 EPROM @ U23
- 1 - 8T245 or 74F245 @ U24
- 1 - INS2651N (NAT) @ U1
- 1 - 75188 (MC1488) @ U11
- 1 - 75189 (MC1489) @ U2
- 1 - MSM5832 MPU (OKI) real time clock/calender @ U10
- 2 - HM-6513-9 512x4 CMOS static RAM (NAT), (HAR) @ U15, 16

MODIFICATIONS TO THE SOLDER SIDE: Refer to the layout below

- 1 - 10 pF/100V Mica capacitor @ pin 1 of U9 to bus strip directly below
- 1 - 1 MΩ resistor @ U15, pin 9 to U15, pin 17

CONNECT insulated jumper wires on the SOLDER SIDE as shown

- 1 - pin 10 of U24 to interface pin 26 (GND) of edge card connector @ A-A
- 1 - pin 20 of U24 to interface pin 25 (+5V) of edge card connector @ B-B

MODIFICATIONS TO THE SOLDER SIDE

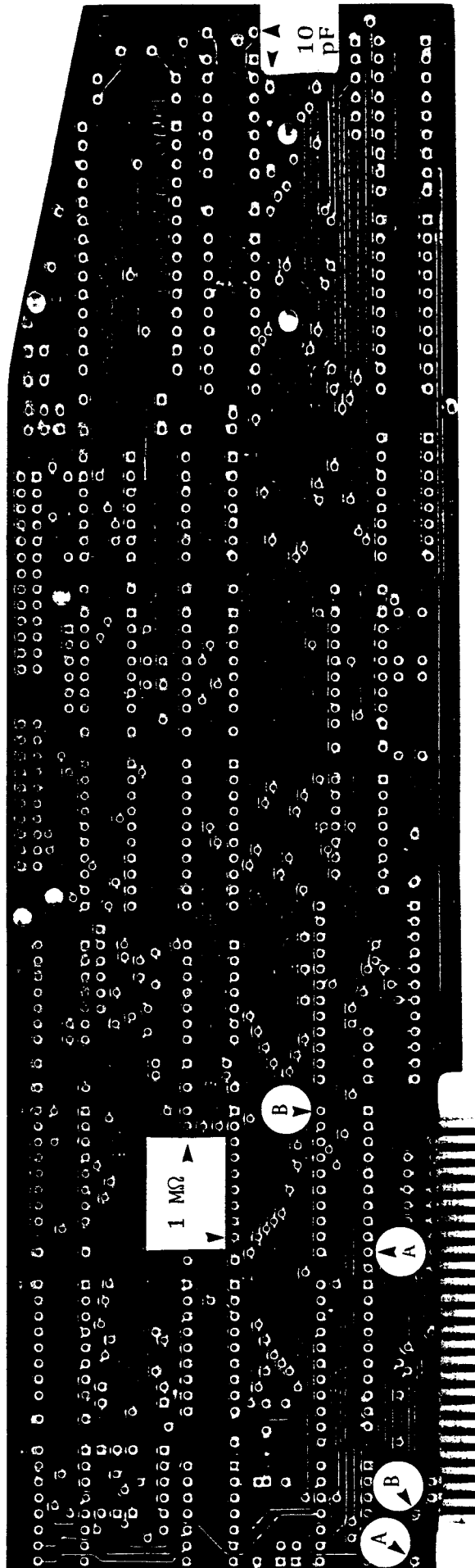

GUIDE 10-5

IEEE-INSTRUMENT CONTROLLER CARD: A parallel communication interface between the host computer and digitally-controlled equipment (for test, measure and control). Supports the instrument bus sanctioned by the IEEE. With power off, install in any slot except 0 (slot 3,4, or 5 recommended). Requires firmware (one EPROM) and documentation.

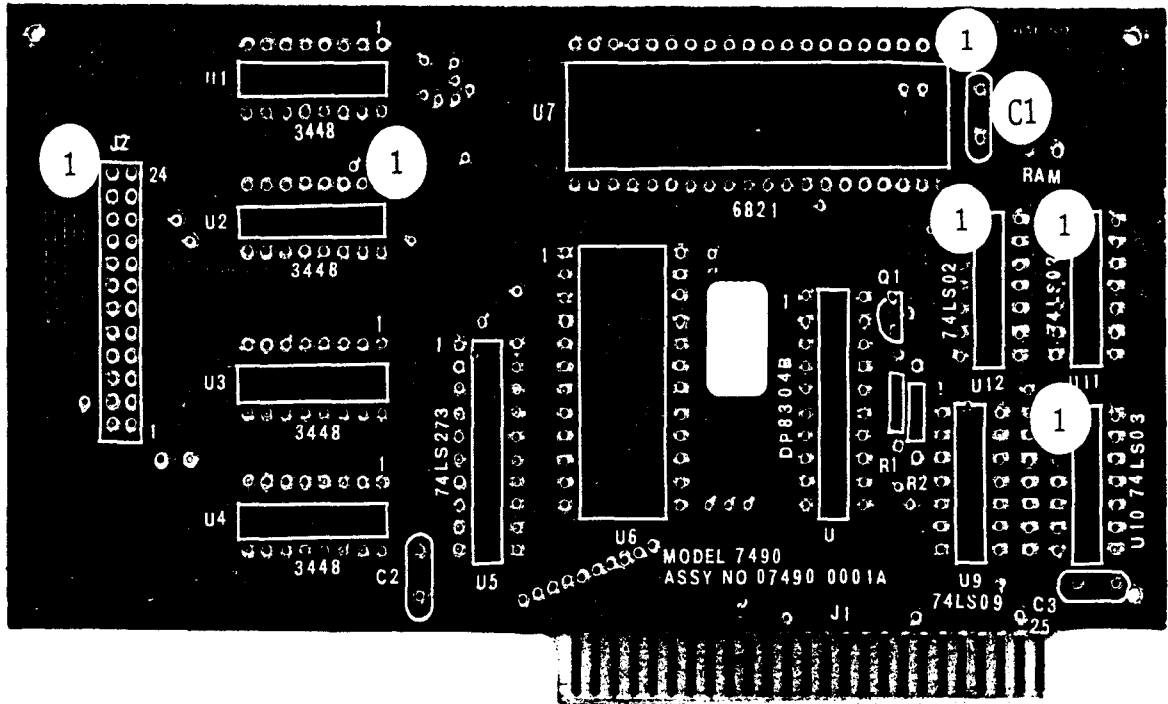

SEQUENCE *INDICATES A PRECAUTION

RESISTORS 1/4 watt, 5%

- 2 - 220 Ω @R1,2
 - 1 - 2.2 KΩ 8-pin SIP between U9 & U10
- *Pin 1 (common) is directly between U12 & U11

SOCKETS *Match pin 1 of sockets with pin 1 on the layout. Check that ALL pins have passed thru ALL holes.

- 4 - 14-pin
 - 4 - 16-pin
 - 2 - 20-pin
 - 1 - 24-pin
 - 1 - 40-pin
- pin 1 > 1
for ALL sockets and ICs
-

CAPACITORS C

- 3 - 0.1 uF Monolithic @ C1 (between U7 & "RAM"), C2, C3

TRANSISTOR Q *Install the three EBC leads as shown

- 1 - 2N3906 @ Q1



CONNECTOR

- 1 - 2x12 male header strip, straight @ J2

INTEGRATED CIRCUITS *Match pin 1 of ICs with pin 1 on the layout

- 4 - 3448 @ U1,2,3,4
- 1 - 74LS273 @ U5
- 1 - 2716 EPROM @ U6
- 1 - 6821 PIA @ U7
- 1 - DP8304B @ U ("8" is missing)
- 1 - 74LS09 @ U9
- 1 - 74LS03 @ U10
- 1 - 74LS00 @ U11
- 1 - 74LS02 @ U12

RAM OPTION

- 1 - 1x2 male header strip, straight @ RAM
- Jumper the two pins and replace the EPROM with 2K x 8 RAM @ U6



GUIDE 10-6

A/D-D/A CARD: A data acquisition, recording, and monitoring system. Has on-board 8-channel (optional 16-channel) analog to digital converter, as well as expandable 1-channel digital to analog converter. With power off, install in slot number 2. Requires software (one disc).

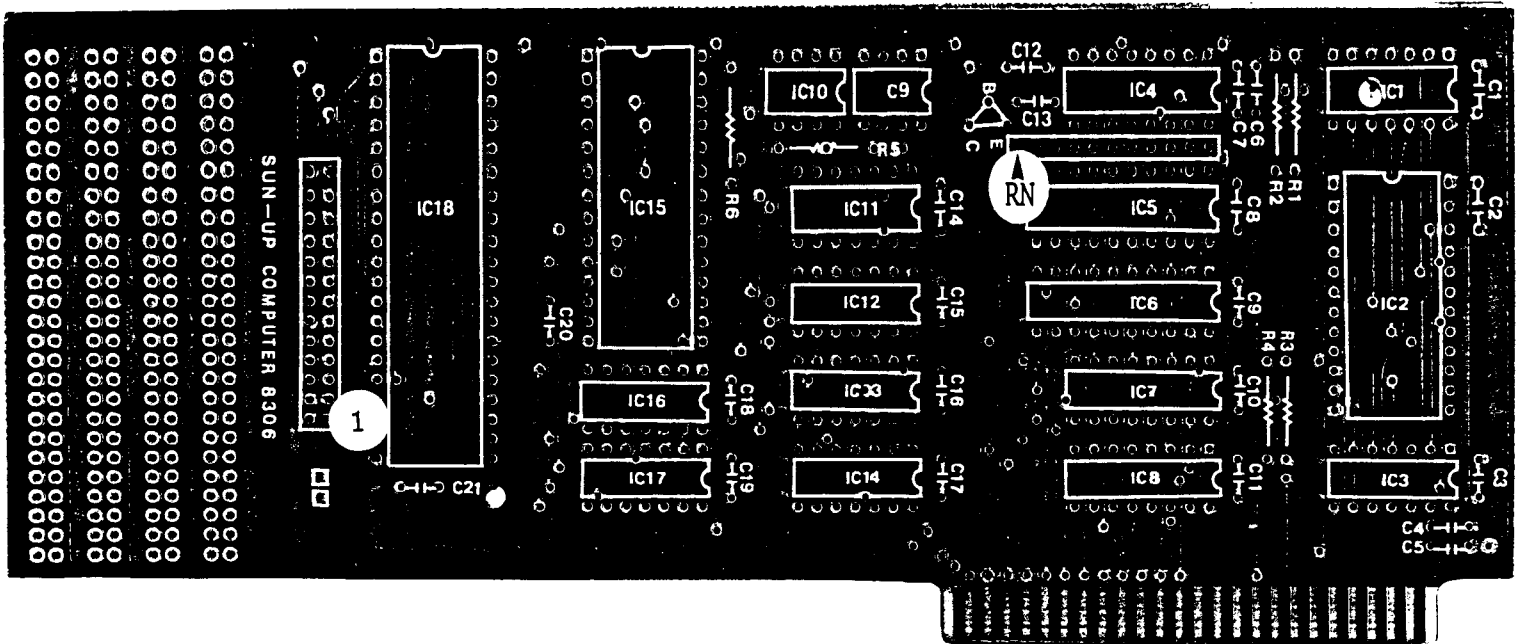

SEQUENCE *INDICATES A PRECAUTION

RESISTORS R ¼ watt, 5%

- _____ 4 - 4.7 KΩ @ R1,2,3,4,5
- _____ 1 - 10 KΩ 11-pin trimpot @ RN*

*Position common pin as shown by the arrow

- _____ 1 - 100 KΩ 2 cm rectangular trimpot, multiturn @ R6

SOCKETS *Match pin 1 of sockets with pin 1 on the layout. Check that ALL pins have passed thru ALL holes

- _____ 2 - 8-pin
- _____ 8 - 14-pin
- _____ 3 - 16-pin
- _____ 2 - 20-pin
- _____ 1 - 24-pin
- _____ 1 - 28-pin
- _____ 1 - 40-pin

CAPACITORS C

- _____ 1 - 100 pF @ C8
- _____ 20 - 0.1 uF Monolithic @ C1,2,3,4,5,6,7, C8,9,10,11,12,13,14,15,16, C17,18,19,20,21

TRANSISTOR Q *Position the three EBC leads correctly

- _____ 1 - 2N3904

CONNECTOR

- _____ 1 - 2x13 male header strip, straight

INTEGRATED CIRCUITS *Match pin 1 of ICs with pin 1 on the layout

- _____ 1 - 74LS00 @ IC16
- _____ 3 - 74LS02 @ IC1,3,14
- _____ 1 - 74LS04 @ IC17
- _____ 1 - 74LS32 @ IC32
- _____ 2 - 74LS74 @ IC11,13
- _____ 2 - 74LS365 @ IC7,8
- _____ 2 - 74LS373 @ IC5,6
- _____ 1 - DM74159 @ IC2
- _____ 1 - DAC0808 @ IC4
- _____ 1 - ADC0808 @ IC15 *For 8-channel
- _____ 1 - MC1456 @ IC9
- _____ 1 - - @ IC10
- _____ 1 - ADC0816 @ IC18 *For 16-channel

*USE EITHER IC15 OR IC18 BUT NOT BOTH

CABLE

- _____ 1 - to suit



K-CLOCK CARD: Real-time clock/calender with 3.6 V rechargeable battery on board. Battery charges when computer is on. With power off, install in any slot except 0 (slot 5 recommended). Requires software (one disc).

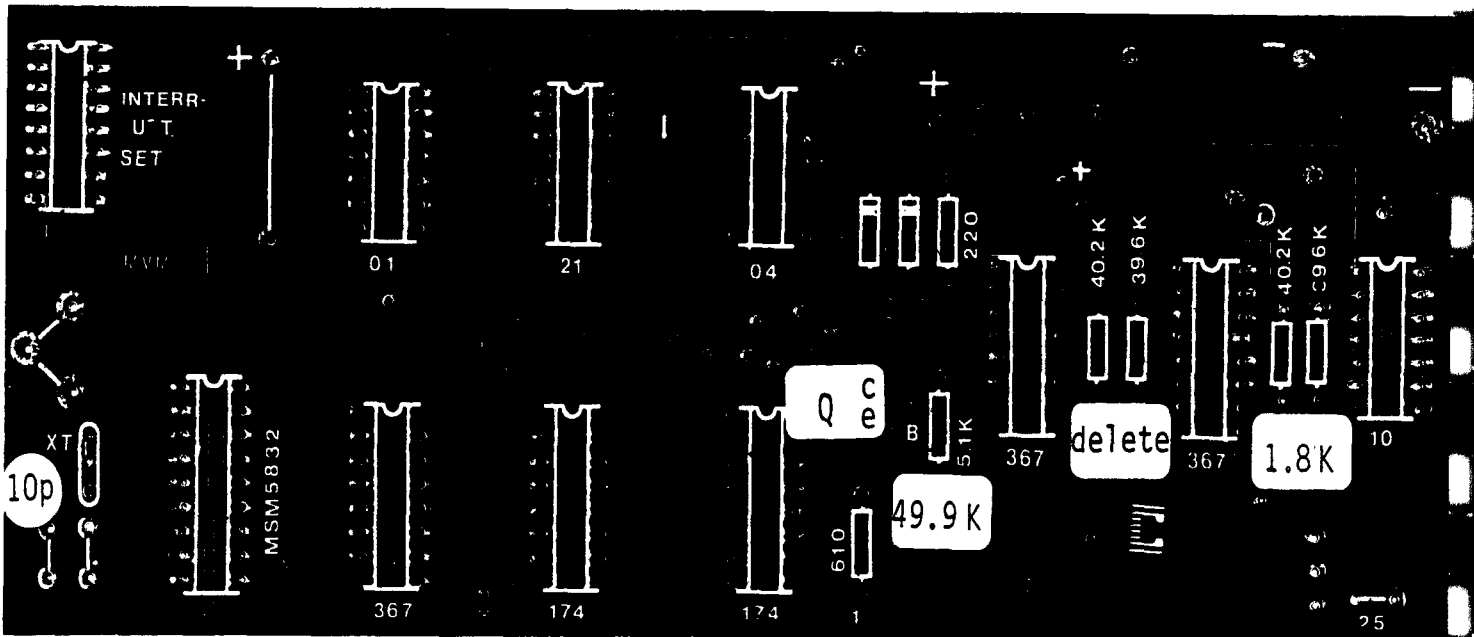

SUGGESTED ORDER OF INSTALLATION *A PRECAUTION

DIODES D *Position banded end (cathode) of diode as shown



▲ cathode end

- ___ 2 - 1N4148

RESISTORS R ½ watt, 1% except 220 Ω

- ___ 1 - 220 Ω 5%
- ___ 1 - 610 Ω @ 610
- ___ 2 - 1.80 KΩ
- ___ 1 - 49.9 KΩ

SOCKETS *Match pin 1 of sockets with pin 1 on the layout. Check that ALL pins have passed thru ALL holes

- ___ 4 - 14-pin
- ___ 5 - 16-pin
- ___ 1 - 18-pin

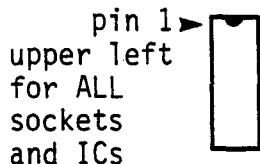

CAPACITORS C

- ___ 1 - 10 pF
- ___ 3 - 0.1 μF
- ___ 1 - 10 μF/40V Axial *Match + of axial with+ on the layout
- ___ 1 - 30 pF variable capacitor

TRANSISTOR Q Install the EBC leads as shown on the layout

- ___ 1 - 2N3904 @ Q

CRYSTAL Y

- ___ 1 - 32.708 KHz @ XT

SWITCH

- ___ 1 - 8-position DIP @ INTERRUPT SET

BATTERY

- ___ 1 - 3.6 V NiCad, rechargeable appropriately mounted

INTEGRATED CIRCUITS *Match pin 1 of ICs with pin 1 on the layout

- ___ 1 - 74LS01
- ___ 1 - 74LS04
- ___ 1 - 74LS10
- ___ 1 - 74LS21
- ___ 2 - 74LS174
- ___ 3 - 74LS367
- ___ 1 - MSM5832 (OKI) real-time clock/calender

GUIDE 10-8

6522 VIA: Allows user to perform I/O and timing/counting functions in 6502-based systems. The 6522 VIA chip shares the same bus and control signals provided by the 6502 MPU. Has four 16-pin sockets for connection to peripheral devices. With power off, install in any slot except 0. Requires documentaion.

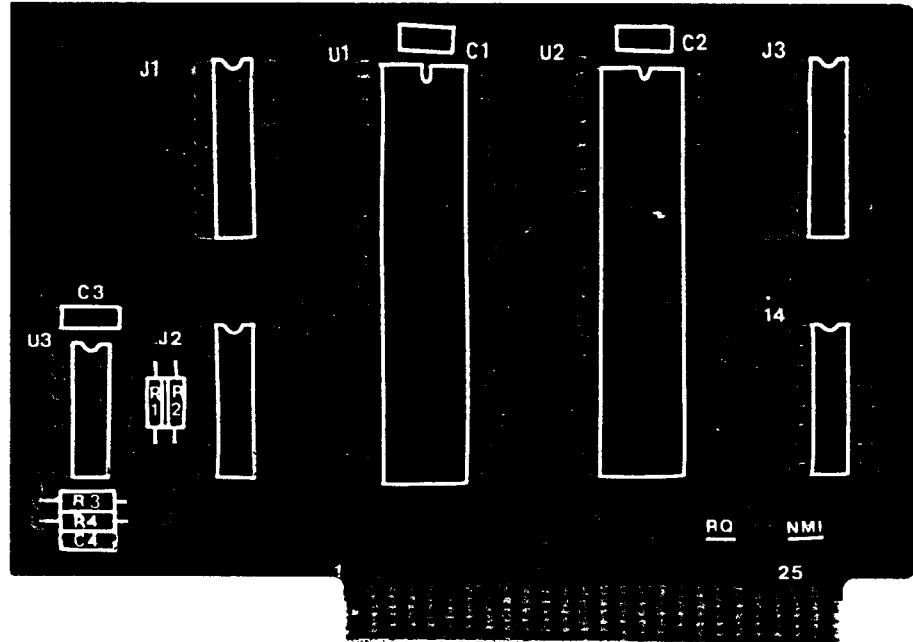

SUGGESTED SEQUENCE *INDICATES A PRECAUTION

RESISTORS R ¼ watt, 5%

- 2 - 1 KΩ @ R1,2
- 2 - 4.7 KΩ @ R3,4

SOCKETS *Match pin 1 of sockets with pin 1 on the layout. Check that ALL pins have passed thru ALL holes

- 1 - 14-pin
- 2 - 40-pin
- 4 - 16-pin for connection to peripheral devices via ribbon cables

CAPACITORS C

- 3 - 0.1 μF Monolithic @ C1,2,3
- 1 - 100 pF Disc @ C4

INTEGRATED CIRCUITS *Match pin 1 of ICs with pin 1 on the layout

- 1 - 74LS05
- 2 - R6522P VIA (versatile interface adapter) IC

JUMPERS

- 2 - 2-pin male header as feed-thru @ IRQ & MNI
- 1 - solder jumper on solder side for 12V supply for peripherals (as required)

pin 1 →
upper left for
ALL sockets
and ICs



GUIDE 10-9

PRO-TIME CARD: Versatile real time clock/calender used with DOS & ProDOStm operating systems. Gives access to year, month, day, hour, minute, second, for dating files. With optional transducer can give remote control of AC outlets. With power off, install in any slot 1 thru 7. Requires software (one disk) & firmware (one EPROM).

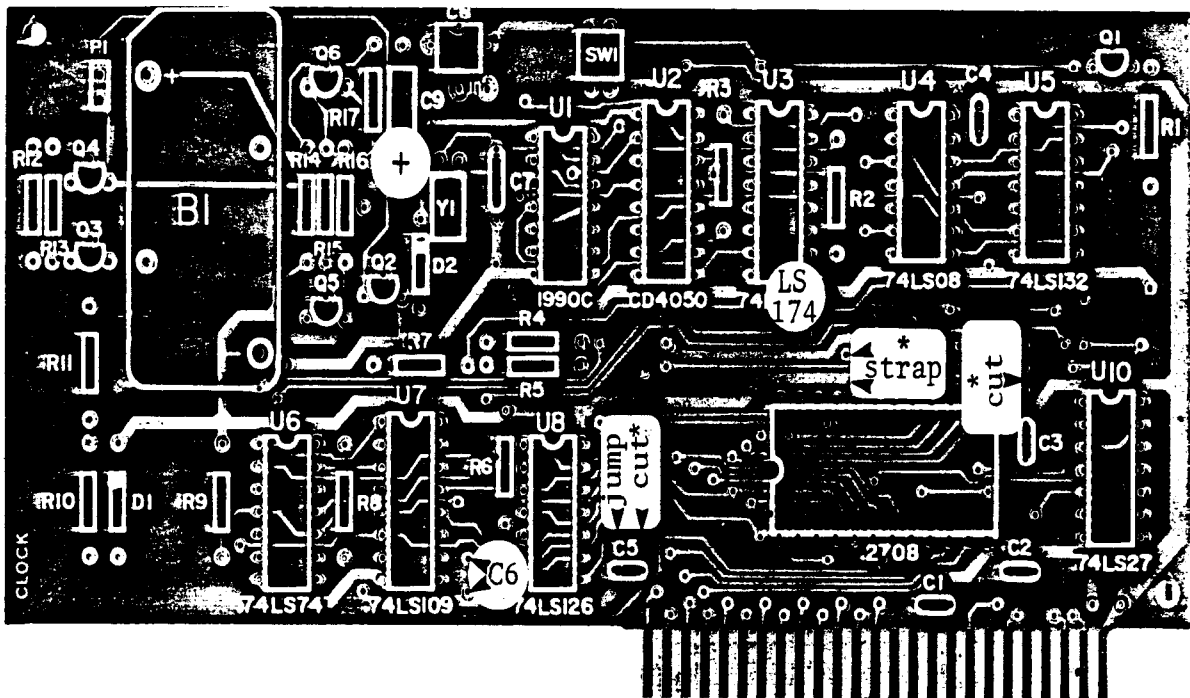

*MODIFICATION FOR USE WITH 2716 EPROM:
Requires two cuts & two jumpers as shown on layout

SEQUENCE *INDICATES A PRECAUTION

DIODES D *Position banded end (cathode) of diodes towards the band on the layout

- 1 - 1N5226 @ D1
- 1 - 1N4001 @ D2

RESISTORS R 1/2 watt, 5%

- 1 - 82 Ω @ R10
- 1 - 470 Ω @ R16
- 1 - 1 KΩ @ R15
- 2 - 3.3 KΩ @ R6,9
- 1 - 4.7 KΩ @ R17
- 3 - 10 KΩ @ R1,7,11
- 1 - 15 KΩ @ R14
- 5 - 47 KΩ @ R2,3,4,5,8
- 2 - 1 MΩ @ R12,13

SOCKETS *Match pin 1 of sockets with pin 1 on the layout. Check that ALL pins have passed thru ALL holes

- 6 - 14-pin pin 1 
- 3 - 16-pin
- 1 - 24-pin

CAPACITORS C *

- 1 - 22 pF @ C7* Try 10pF
- 6 - 0.1 μF Monolithic @ C1,2,3,4,5,6
- 1 - 4.7 μF/16V Radial* @ C9 Match + of Radial with + on the layout
- 1 - 5-50 pF Trimcap @ C8 (fast/slow adjust)

CRYSTAL Y

- 1 - 32.768 KHz @ Y1

TRANSISTORS Q *Position EBC transistors leads as shown

- 5 - 2N3904 @ Q1,2,3,4,6
- 1 - 2N3906 @ Q5

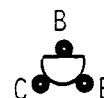

SWITCH

- 1 - two-position DIP @ SW1 (set/protect switch)

CONNECTORS

- 1 - 2-pin header, male, 90° @ P1 (for optional transducer)

BATTERY

- 1 - 3.6 V rechargeable NiCad (GE DS3D) (or appropriate substitute)

INTEGRATED CIRCUITS *Match pin 1 of ICs with pin 1 on the layout

- 1 - 74LS08 @ U4
- 1 - 74LS27 @ U10
- 1 - 74LS74 @ U6
- 1 - 74LS109 @ U7
- 1 - 74LS126 @ U8
- 1 - 74LS132 @ U5
- 1 - 74LS174 @ U3

- 1 - UPD1990C (NEC) @ U1 clock IC
- 1 - CD4050 @ U2

NuScope Associates



GUIDE 10-10

MULTIFUNCTION II (IIE): Provides: serial printer port; RS232 asynchronous serial communications port for remote terminal or external modem; real time clock/calendar with battery back-up. With power off, install in slot 1. Requires software (one diskette) and firmware (one EPROM).

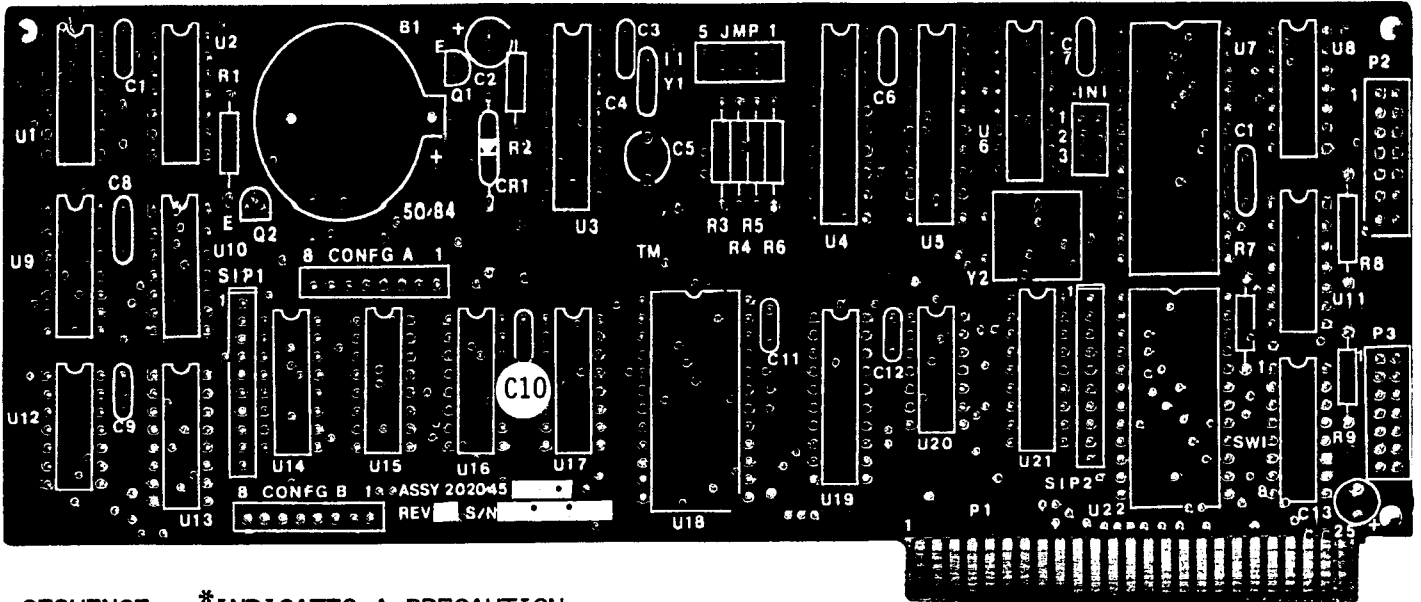

SEQUENCE *INDICATES A PRECAUTION

DIODE *Position banded end of diode towards the arrow

1 - 1N914 @ CR1

RESISTORS R ¼ watt, 5%

4 - 4.7 KΩ @ R1,7,8,9

5 - 10 MΩ @ R2,3,4,5,6

2 - 4.7 KΩ 10-pin SIP* bussed, @ SIP 1,2. *Match pin 1 of SIP with pin 1 on layout

SOCKETS *Match pin 1 of sockets with pin 1 on the layout. Check that ALL pins have passed thru ALL holes

8 - 14-pin

6 - 16-pin

2 - 18-pin

3 - 20-pin

3 - 24-pin

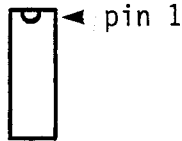

CAPACITORS C. *C1, above R7 is NOT equipped

1 - 22 pF @ C4

9 - 0.1 μF Monolithic @ C1,3,6,7,8,9, C10,11,12

2 - 1 μF/16V Tantalum* @ C2,13

*Match + of Tantalum with + on the layout

1 - 5-50 pF Trimcap @ C5

TRANSISTORS Q *Match ebc transistor leads as shown on the layout

1 - 2N2907A @ Q1

1 - 2N2222A @ Q2

CRYSTAL Y

1 - 32.768 KHz @ Y1

1 - 5.068 MHz @ Y2* Fold crystal flat against the card before soldering

SWITCH

1 - 8-position DIP @ SW1 -baud rate

HEADERS male, straight

2 - 1x8 @ CONFIG A,B -slot select

1 - 2x3 @ INI

1 - 2x5 @ JMP1 -set clock

2 - 2x7 @ P2 -printer port

@ P3 -communica. port

BATTERY Match + of battery with + on layout

1 - 3 V Lithium @ B1

INTEGRATED CIRCUITS * Match pin 1 of ICs with pin on the layout

1 - 74LS00 @ U9 1 - 74LS367 @ U6

1 - 74LS04 @ U2 1 - 74LS373 @ U4

1 - 74LS08 @ U12 1 - 1488 @ U8

1 - 74LS21 @ U10 1 - 1489 @ U11

1 - 74LS32 @ U20 2 - 68A50 @ U7,22

1 - 74LS74 @ U1 1 - COM8116 @ U21

1 - 74LS133 @ U17 1 - M5832 @ U3

3 - 74LS138 @ U13 1 - 2732 @ U18

U14,15

1 - 74LS157 @ U16

1 - 74LS245 @ U19

1 - 74LS273 @ U5



GUIDE 10-11

ACE DUAL I/O CARD: Centronics-compatible parallel printer interface and serial communication (RS232) interface on one card. With power off, install in slot 1 or 2. Use switch settings to control "phantom" slot assignment. Requires firmware (one EPROM). Documentation & schematics available from supplier.

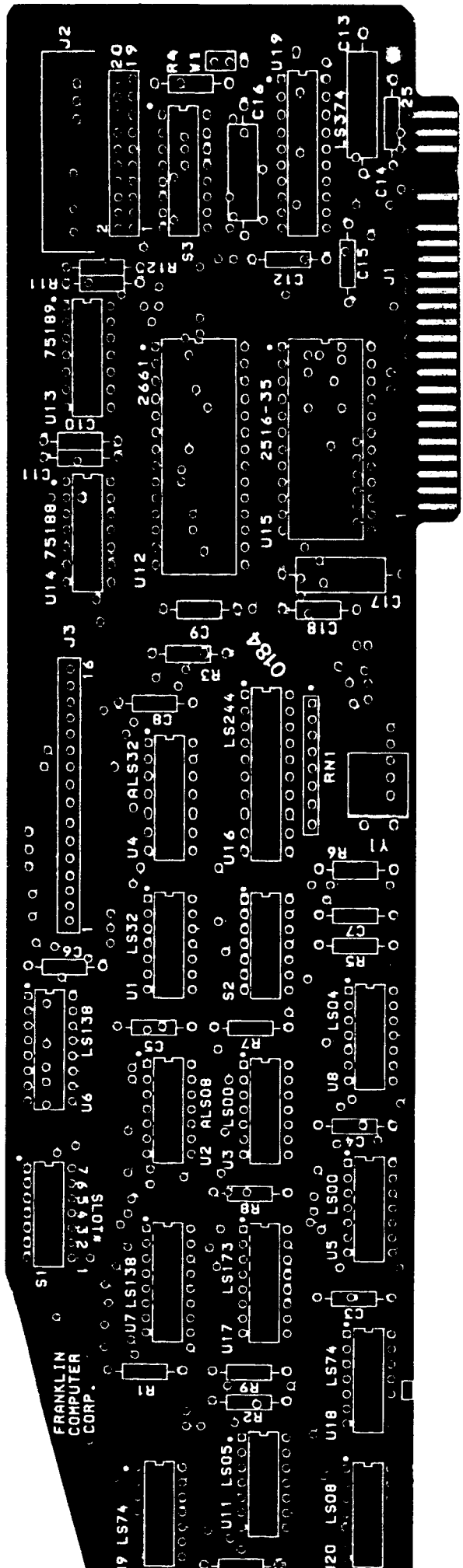

*INDICATES A PRECAUTION

- RESISTORS R 1/4 watt, 5%
 - 1 - 100 Ω @ R4
 - 2 - 1.5 KΩ @ R5,6
 - 3 - 4.7 KΩ @ R1,7,8
 - 6 - 10 KΩ @ R2,3,9,10,11,12
 - 1 - 1 KΩ 8-pin SIP* bussed @ RNI
- *Match pin 1 od SIP with pin 1 (white dot) on the layout
- *Match pin 1 of sockets with pin 1 on the layout. Check that ALL pins pass thru ALL holes
 - 12 - 14-pin pin 1
 - 3 - 16-pin pin 1
 - 2 - 20-pin pin 1
 - 1 - 24-pin pin 1
 - 1 - 28-pin pin 1

CAPACITORS C

- 1 - 0.01 F Monolithic @ C7
- 14 - 0.1 F Monolithic @ C1,2,3,4,5,6,8,9,10,11,12,14,15,18
- 3 - 10 F/16V Axial* @ C13,16,17
- *Match + of Axial with + on layout

CRYSTAL Y *Insulate and fold flat against the card before soldering

- 1 - 4.9152 MHz @ Y1

SWITCH

- 2 - 7-position DIP @ S1, S2
- 1 - 8-position DIP @ S3

CONNECTORS

- 1 - 1x2 header, right angle @ W1
- 1 - 1x16 header, right angle @ J3 - Parallel
- 1 - 1x20 header, right angle @ J2 - Serial
- 1 - shorting clip for W1

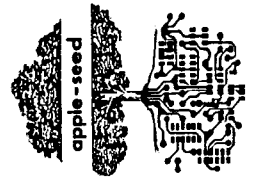

NuScope Associates

JAL I/O CARD (continued)

SEPARATED CIRCUITS *Match pin 1 of ICs with pin 1 on the layout. U10 is NOT shown on the layout.

- 2 - 74LS00 @ U3,5
- 1 - 74LS04 @ U8
- 1 - 74LS05 @ U11
- 1 - 74LS08 @ U20
- 1 - 74LS32 @ U1
- 2 - 74LS74 @ U9,18 (TI only)
- 2 - 74LS138 @ U6,7
- 1 - 74LS173 @ U17
- 1 - 74LS244 @ U16
- 1 - 74LS374 @ U19

- 1 - 74ALS08 @ U2
- 1 - 74ALS32 @ U4 (74LS32)

- 1 - 75188 @ U14 (MC1488)
- 1 - 75189 @ U13 (MC1489)

- 1 - 2661 USART @ U12
- 1 - 2716 EPROM @ U15

GUIDE 11-1

PROTOTYPING CARD I: For high-density wire wrap prototyping work. Has over 1,900 solder pads on 0.1 inch spacing.



COMPONENT SIDE

25 +5V
 24 DMA OUT
 23 INT OUT
 22 DMA IN
 21 PDY STROBE
 20 N.C.
 19 R/W
 18 R/W
 17 A15
 16 A14
 15 A13
 14 A12
 13 A11
 12 A10
 11 A9
 10 A8
 9 A7
 8 A6
 7 A5
 6 A4
 5 A3
 4 A2
 3 A1
 2 I/O SEL
 1 I/O SEL

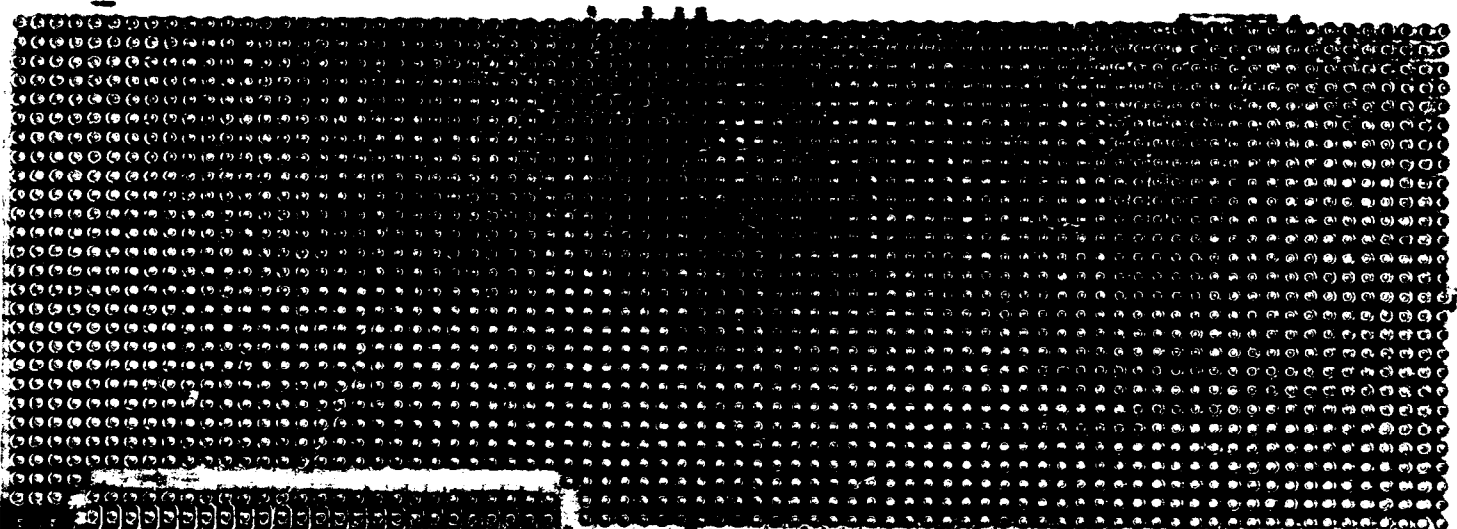

SOLDER SIDE

26 GND
 27 DMA IN
 28 INT IN
 29 INT IN
 30 INT IN
 31 RES
 32 INT IN
 33 -12V
 34 -5V
 35 N.C.
 36 7M
 37 Q3
 38 Q1
 39 USER 1
 40 USER 2
 41 DEV SEL
 42 D7
 43 D6
 44 D5
 45 D4
 46 D3
 47 D2
 48 D1
 49 D0
 50 +12V



PROTOTYPING CARD II: For point-to-point hand-wired custom work. Has on-board +5 V power bus & ground bus.

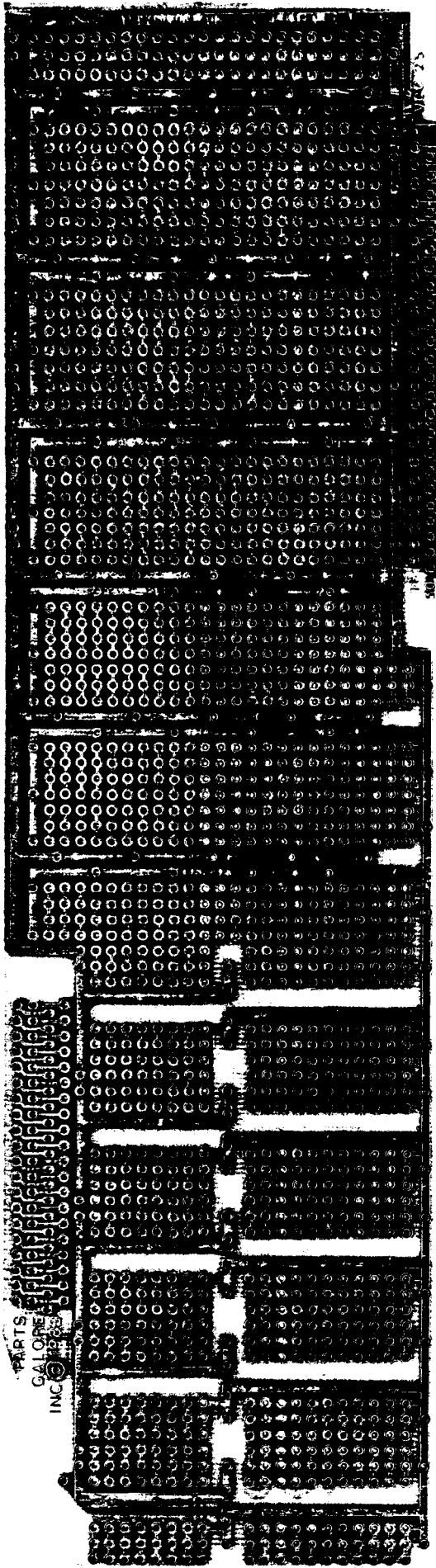

COMPONENT SIDE

- 25 +5V
- 24 DMA OUT
- 23 INT OUT
- 22 DMA
- 21 RDY
- 20 I/O STROBE
- 19 N.C.
- 18 R/W
- 17 A15
- 16 A14
- 15 A13
- 14 A12
- 13 A11
- 12 A10
- 11 A9
- 10 A8
- 9 A7
- 8 A6
- 7 A5
- 6 A4
- 5 A3
- 4 A2
- 3 A1
- 2 A0
- 1 I/O SEL

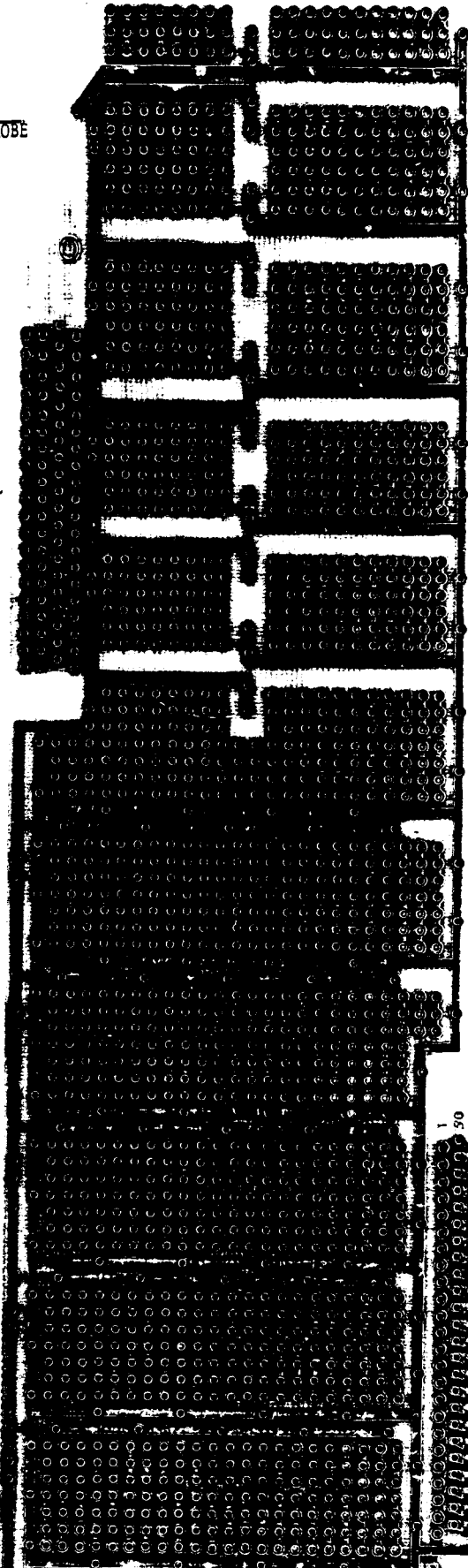

SOLDER SIDE

- GND 26
- DMA IN 27
- INT IN 28
- INT 29
- RES 30
- INT 31
- RES 32
- 12V 33
- 5V 34
- N.C. 35
- 7M 36
- Q3 37
- Q3 38
- USER 39
- DEV SEL 40
- D7 41
- D6 42
- D5 43
- D4 44
- D4 45
- D3 46
- D2 47
- D1 48
- D0 49
- 12V 50

NuScope Associates



GUIDE 11-3

PROTOTYPING CARD III: For point-to-point hand-wired custom work.

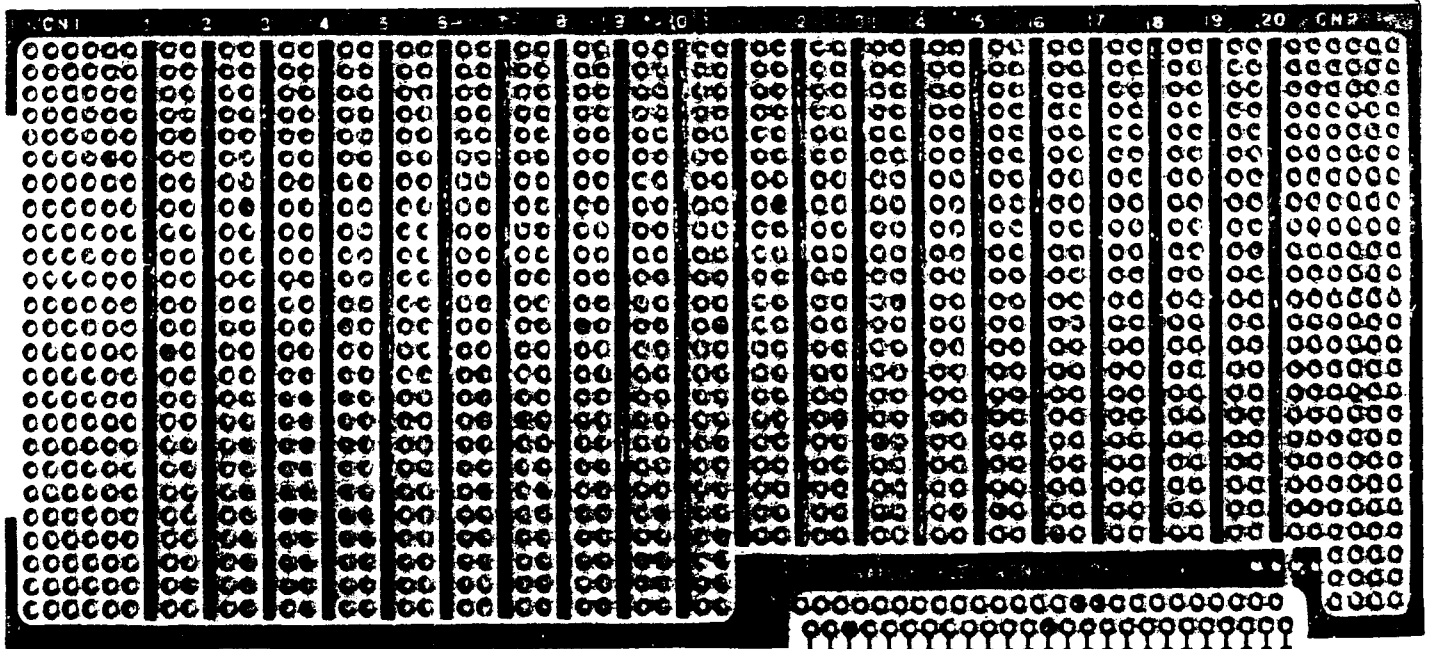

COMPONENT SIDE

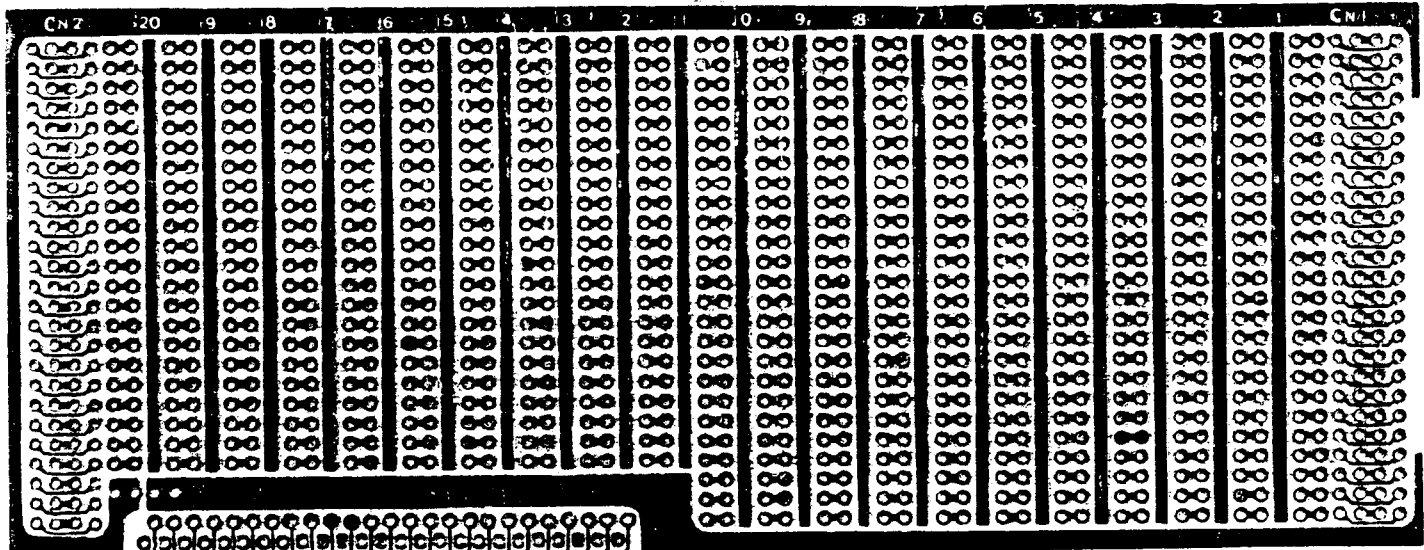
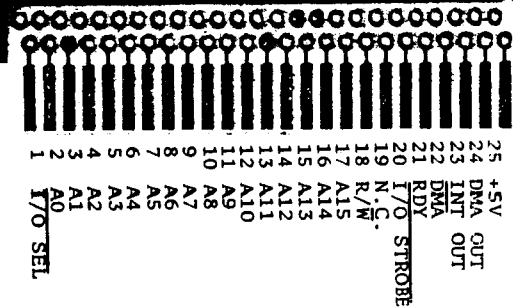

SOLDER SIDE

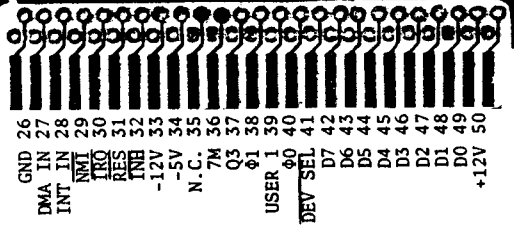

GUIDE 11-4

EXTEND-A-CARD: Lifts card 5 cm above the motherboard for easy testing & servicing.

Secure a 50-pin card edge connector to the top of the card so that the pins of the connector line up with the traces on the card. Centre the connector and solder the end pins to the card. Check that pins are correctly lined up. Solder the remaining pins to the card. Appropriately label one end of the connector pin 1 and pin 26.

SOLDER CARD EDGE CONNECTOR
TO
TOP OF CARD



gold fingers

CONNECT TO MOTHERBOARD



GUIDE 11-5

EK CARD EXTENDER: Lifts card 11 cm above the motherboard for ease of servicing testing and troubleshooting.

Secure a 50-pin card edge connector to the top of the card so that the pins of the connector line up with the traces on the card. Solder the four end pins to the card. Check that the rest to the pins are aligned. Solder the remaining pins to the card. Appropriately label one end of the connector pin 1 and pin 26.

SOLDER CARD EDGE CONNECTOR
TO
TOP OF CARD

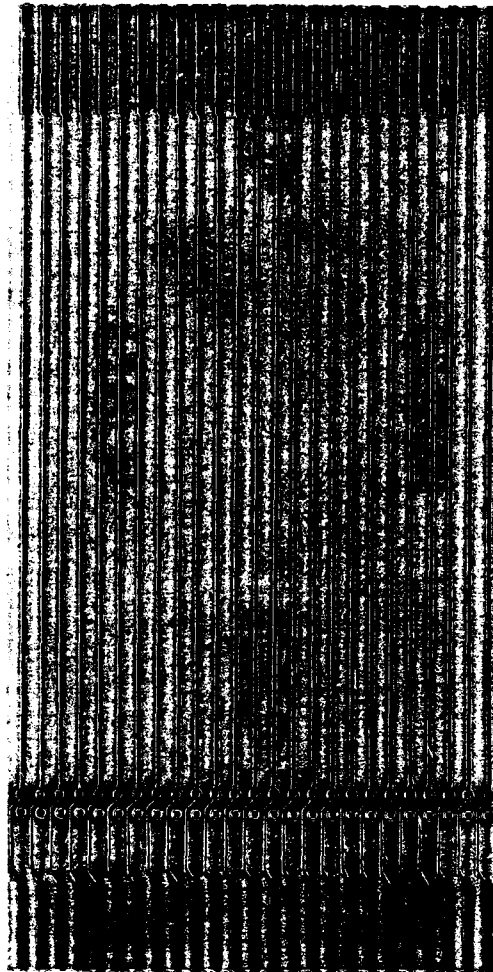

gold fingers

INSTALL IN MOTHERBOARD



GUIDE 11-6

PROTOTYPING IV: For high-density wire wrap prototyping work. Has approximately 2,000 solder pads on 0.1" spacing.

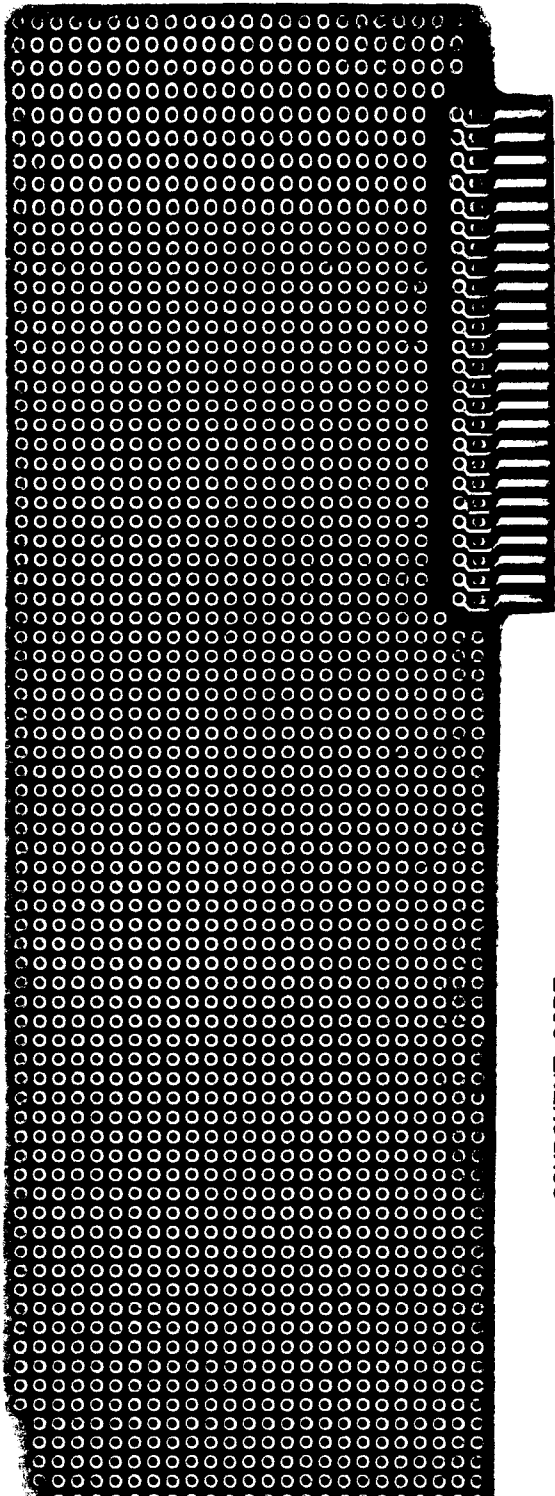

COMPONENT SIDE

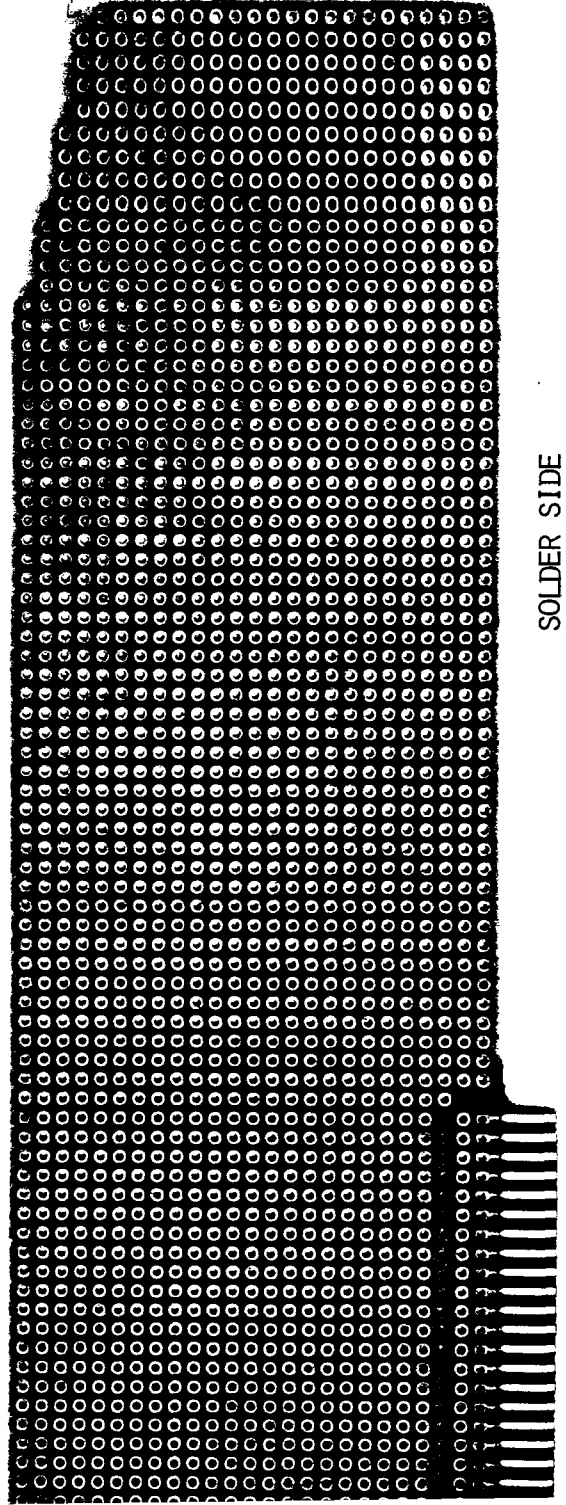

SOLDER SIDE

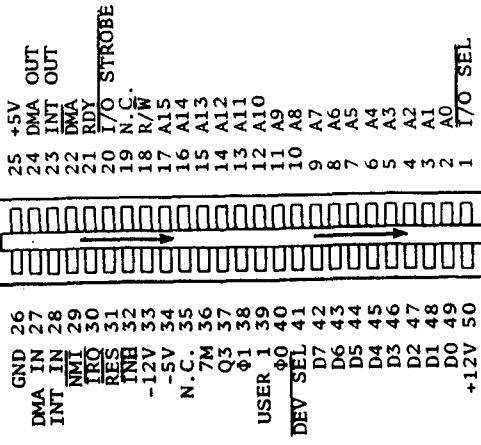

GUIDE 11-7

JK EXTENDER: Lifts card 9 cm above the motherboard for easy testing & servicing.

Secure a 50-pin card edge connector to the top of the card so that the pins of the connector line up with the traces on the card. Centre the connector and solder the end pins to the card. Check that pins are correctly lined up. Solder the remaining pins to the card. Appropriately label one end of the connector pin 1 and pin 26.

SOLDER CARD EDGE CONNECTOR
TO
TOP OF CARD

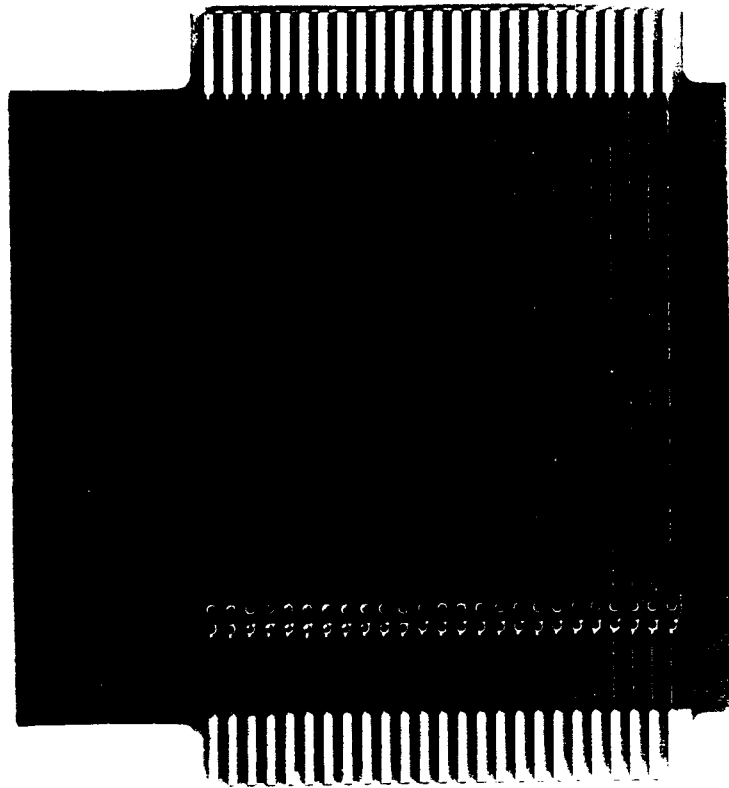

gold fingers

CONNECT TO MOTHERBOARD

NuScope
Associates



GUIDE 11-8

APL PROTOTYPING V: Two-sided prototyping PCB for point-to-point or wire-wrap custom work. Solder pads are on 0.1 spacing. Has power and ground bus. Documentation available from supplier.

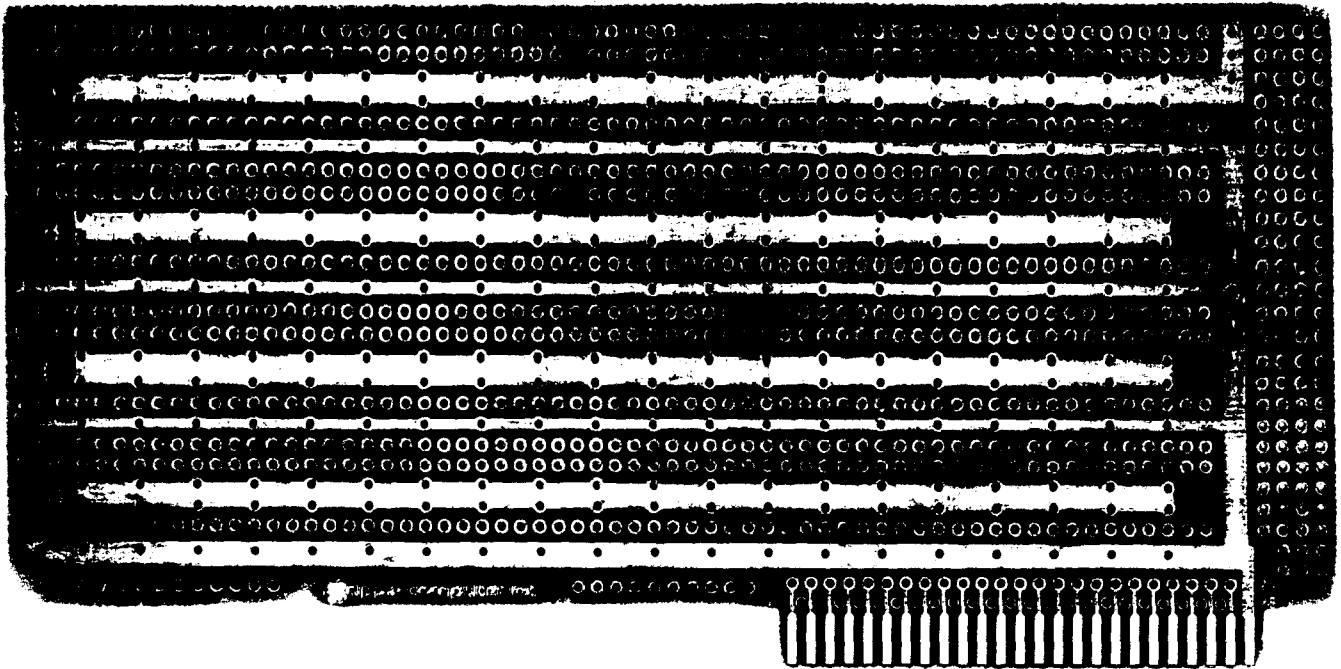

+5V
 24 DMA OUT
 23 INT OUT
 22 DMA
 21 RDY
 20 I/O STROBE
 19 N.C.
 18 R/W
 17 A15
 16 A14
 15 A13
 14 A12
 13 A11
 12 A10
 11 A9
 10 A8
 9 A7
 8 A6
 7 A5
 6 A4
 5 A3
 4 A2
 3 A1
 2 A0
 1 I/O SEL

COMPONENT SIDE

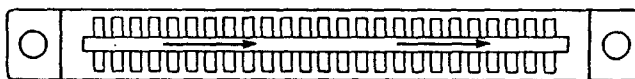

SOLDER SIDE

26 GND
 27 DMA IN
 28 INT
 29 INT
 30 I/O
 31 RES
 32 INT
 33 -12V
 34 -5V
 35 N.C.
 36 7M
 37 Q3
 38 Φ1
 39 USER 1
 40 USER 2
 41 DEV SEL
 42 D7
 43 D6
 44 D5
 45 D4
 46 D3
 47 D2
 48 D1
 49 D0
 50 +12V

