



T.M.

Videoterm 80 Column Display

Installation and Operation Manual

>Edit: A(djst C(py D(lete F(ind I(nsrst J(mp R(place Q(uit X(chng Z(ap [1.1]

The VIDEOTERM 80 Column Display for the Apple][computer gives full 80 by 24 upper/lower case display and compatibility with DOS, CP/M and Pascal environments. Below is a sample of Videoterm text.

of transmitting characters to a display device at ultra high speed regardless of the mapping scheme of that device or whether the device allows memory mapped display at all. The primary application of this method would be for use with word processors and communication packages.

The primary drawback of word processors that take advantage of memory mapped video is that they require the display memory to be contiguous and do not utilize advanced features such as hardware scrolling in the display device. A secondary drawback is that the word processor must be written to accomodate non-memory mapped devices as well and must handle these in a different way.

The approach to solving these problems is to define general purpose drivers that can be used with non-memory mapped devices and can also be made to drive memory mapped devices at very high speed.

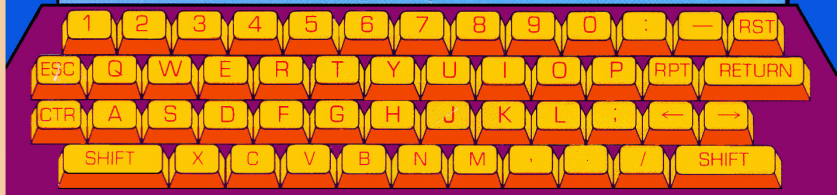

VIDEX VIDEOTERM
Installation and Operation Manual

Curtis White
Darrell Aldrich

Fourth Edition
November 1982

First Printing: March, 1980
Second Printing: August, 1980
Third Printing: January, 1982

Published by:
VIDEX
897 N.W. Grant Ave.
Corvallis, Oregon 97330
Phone: [503] 758-0521

All rights reserved. No part of this publication may be reproduced without prior written permission of VIDEX. Please call for more information.

Copyright © 1980 by VIDEX.

Apple][® Apple Computer, Inc.
Micromodem][® D.C. Hayes Associate, Inc.
ROMWriter® Mountain Hardware, Inc.
EasyWriter® Information Unlimited Software, Inc.
Softcard® Microsoft

Apple PIE® Programma International, Inc.
Video 100 is a product of Leedex Corporation

Videx is a trademark of Videx, Inc.

TABLE OF CONTENTS

Disclaimer	vii
Warranty	viii
OVERVIEW	
Introduction	1-1
Physical Description	1-3
VIDEOTERM Features	1-6
Apple][Hardware Peprerequisites and Options	1-10
INSTALLATION AND CHECKOUT	
How to Install the VIDEOTERM Board	2-1
Installation Checklist	2-8
Checkout	2-9
How to Verify Correct Performance	2-9
Video Monitor Adjustment	2-13
Fault Diagnosis	2-16
OPERATION	
Using the VIDEOTERM Board	3-1
VIDEOTERM Initialization	3-3
Upper and Lower Case	3-5
Special Key Operation	3-6
SOFTWARE	
Apple Language Interactions	4-1
Assembly Language	4-1
Integer Basic	4-2
Applesoft	4-3
Pascal	4-4
Language Considerations in General	4-7
Software Examples	4-9
Assembly Language	4-9
Integer Basic	4-13
Applesoft	4-22
Pascal	4-28
Using VIDEOTERM with Other Software	4-30
EasyWriter	4-30
Apple PIE	4-30
Others	4-30
Interfacing with Other Peripherals	4-31
Softcard	4-31
D.C. Hayes Micromodem][.....	4-31
Creating New Character Sets	4-35
Text	4-35
Graphics	4-37

FIRMWARE

Firmware Control of the VIDEOTERM Board	5-1
CRTC Internal Register Use	5-2
How to Modify CRTC Registers	5-8
Device Select Operation	5-9
Video Set-Up Flags	5-10
VIDEOTERM Memory Mapping	5-12
VIDEX VIDEOTERM Firmware Listing	5-15

HARDWARE OPERATION

Theory of Operation	6-1
Shift Wire Mod	6-4
The Soft Video Switch	6-5

APPENDIX

ASCII Character Code Chart	A-1
Owners Notes	A-2
Technical Summary	A-3

PROGRAM LISTINGS

Program Listing 1	4-6
Program Listing 2	4-10
Program Listing 3	4-15
Program Listing 4	4-18
Program Listing 5	4-23
Program Listing 6	4-26
Program Listing 7	4-29

FIGURES AND ILLUSTRATIONS

Fig. 1:	Board Installed in System: Interior View	2-2
Fig. 2:	VIDEX Switchplate Assembly Mating with VIDEOTERM Board	2-4
Fig. 3:	Board Installed in System: Exterior View	2-6
Fig. 4:	Insertion of Character Set EPROM into the VIDEOTERM Board	4-35
Fig. 5:	Line Drawing Character Set Keyboard Correspondence	4-38
Fig. 6:	Alternate Character Sets	4-39
Fig. 7:	Standard Character Set	4-44
Fig. 8:	Blank Forms for Future Character Sets	4-52
Fig. 9:	VIDEOTERM Soldering Points	6-7
Fig. 10:	VIDEOTERM Board Photograph	A-4
Fig. 11:	Schematic Diagram of VIDEOTERM Board	Endsheet

TABLES

Table 1:	VIDEOTERM Use of Apple][RAM	3-2
Table 2:	VIDEOTERM Control parameters	3-4
Table 3:	Address Definitions by Language	4-8
Table 4:	CRTC Register Assignments	5-7

Notice:

Videx, Inc. reserves the right to make improvements or changes in the product described in this manual at any time without notice.

Disclaimer of All Warranties and Liability:

Videx, Inc. makes no warranties, neither express nor implied except as explicitly set forth in the Limited Warranty below, with respect to this manual nor with respect to the product described in this manual, its quality, performance, merchantability or fitness for any purpose. Videx, Inc. software is sold or licensed "as is". The entire risk as to its quality and performance is with the buyer. Should the programs prove defective following their purchase, the buyer (and not Videx, Inc., its distributors, or its retailers) assumes the entire cost of all necessary servicing, repair, or correction and any incidental or consequential damages. In no event will Videx, Inc. be liable for direct, indirect, incidental, or consequential damages resulting from any defect in the hardware/software, even if Videx, Inc. has been advised of the possibility of such damages. Some states do not allow the exclusion or limitation of implied warranties or liability for incidental or consequential damages, so the above limitation or exclusion may not apply to you.

VIDEX VIDEOTERM

Limited Warranty:

Videx, Inc. warrants this product to be free from defects in material and workmanship for a period of ninety (90) days from the date of original purchase. Videx, Inc. agrees to repair or, at our option, replace any defective unit without charge. Videx, Inc. assumes no responsibility for any special or consequential damages. No other warranty, neither express nor implied, is authorized by Videx, Inc. Some states do not allow the exclusion or limitation of implied warranties or liability for incidental or consequential damages, so the above limitation or exclusion may not apply to you.

Please return the registration card in order that VIDEX can notify you of new products, VIDEOTERM updates and new software.

Mail to: VIDEX
897 N.W. Grant Ave.
Corvallis, OR 97330

Errata

*
* IMPORTANT NOTICE: THE VIDEOTERM MUST NOW BE PLACED only IN SLOT 3. *
*

Since this manual was published, some changes have been made in the Videoterm and other products. The Soft Video Switch, an automatic version of the Switchplate, was introduced. We generally recommend use of the Soft Video Switch over the Switchplate, however the two may be used together. A new release of firmware, Firmware 2.4, has been included on your Videoterm. Here are some of the features which have been added to your Videoterm by the new firmware:

- * The popular Escape I,J,K & M cursor movement commands
- * Pascal Card Type 6 protocol (eliminating the need for the program Vidpatch, found on page 4-27)
- * The Monitor /// is supported (a CRT from Apple Computer)
- * The Soft Video Switch is supported (page 6-5)
- * The Shift Wire Mod is supported (page 6-4)
- * CP/M's inverse/normal protocol (CNTL-O/CNTL-N)
- * Interrupts are handled properly
- * 20% faster output

There are two features documented in this manual which have been removed:

- * The 80 characters by 18 line format (used by the 7 x 12 character font)
- * Slot independence (the Videoterm MUST be placed in Slot 3)

More new products for your Videoterm include an 80 column VisiCalc Pre-Boot Disc, an AppleWriter][Pre-Boot Disc and a Videoterm Utilities Disc.

OVERVIEW

Introduction

The new Apple II peripheral that you have just purchased combines the features of an asynchronous serial interface card with the "guts" of a high speed terminal to transform your current black and white video monitor into a full feature intelligent video display terminal. When properly adjusted, the interface card clearly displays upper and lower case characters using a 7 by 9 character dot matrix size (the full matrix is actually 9 by 9). An optional 7 by 12 matrix size (full size is 9 by 12) is also available. You may select for 18 or 24 lines each containing 80 characters. Special characters may be defined by the user and preprogrammed EPROM chips are available that offer various character fonts. These capabilities are available under both the Pascal operating system and both Basic languages that Apple Computer, Inc., supplies.

All of these features are included on one printed circuit (PC) board, the size of the Applesoft or Language board, utilizing only 24 integrated circuits. The use of CMOS and low power electronic components reduces the power draw needed for the board to properly function and virtually eliminates power conflicts with other expansion cards. An on-board clock circuit regulates video signal timing, providing the user with a clear, flicker-free video image.

The firmware used with the VIDEOTERM board is fairly transparent to standard Apple II and Apple II-compatible software. The call addresses for various board functions are fully documented, allowing you to interface your software directly with the display software if you desire. Specific software interface information for the D. C. Hayes

Micromodem II (requires an EPROM replacement firmware chip available from VIDEX), the ROMWriter by Mountain Hardware, EasyWriter by Information Unlimited Software and the Microsoft Softcard is included. A variety of other software application examples are included, along with specifics on Apple Basic interaction with the VIDEOTERM.

The remainder of this Overview chapter is devoted to a description of the physical appearance of the VIDEOTERM board, a full description of all features of the board and the necessary Apple II system prerequisites for its proper functioning.

It is best to close with a word of advice concerning your new purchase. Treat it well and with respect as the quality instrument that it is and it will reward you with years of service, probably lasting through the life of your Apple II system. If any difficulty with the unit arises, you should contact the store where you purchased the VIDEOTERM. They should be able to determine if the fault lies with the VIDEOTERM or if your video monitor is incorrectly adjusted. If they cannot help you, please feel free to contact VIDEX directly so that the problem may be quickly corrected.

Physical Description

As you can see when you hold the VIDEOTERM board in your hand, the board is small, compact and relatively uncluttered with electronic components. The implementation of the interface design is quite economic, both in terms of initial purchase price and by minimizing the number of parts which may fail. The board measures only 7.25 by 2.75 inches, about the same size as the Applesoft Basic firmware card or the Language card.

As you look at the component side of the board, you will notice a small crystal can on the right-hand side of the board, possibly with the label 'Crystek'. This is the on-board crystal clock which, with the rest of the clock logic circuit, ensures flicker-free display characters on your monitor. The clock should be labelled 17.430.

At the upper left of the board, you will see the four small prongs of the video signal takeoff jack and a fifth small prong next to it which is the light pen takeoff jack. It is designed to be used with a possible optional light pen.

A separate connector is included which connects these five prongs to a standard video output female plug. This connector will not be included if you have purchased the optional, and more versatile, Switchplate assembly with your VIDEOTERM. The Switchplate assembly has an identical connector end to attach to the VIDEOTERM board. The assembly allows you to switch between the VIDEOTERM's video output signal and the Apple II's video output signal without having to change any of the cable connections. A separate jumper cable, a double-ended male RCA audio cable, connects a second female video jack on the Switchplate to the Apple II's video monitor output female jack located on the

rear of the computer next to the cassette I/O ports. By a simple flick of the switch, you may then display either PR#0 output on your video monitor, this being in the standard default Apple II video output format of 24 lines by 40 characters, or PR#n output (where n is the number of the slot in which the VIDEOTERM board has been placed), which is in the VIDEOTERM output format. Thus, you need only use one monitor with the VIDEOTERM, although it is more convenient and provides more user options if you have two monitors, one a color TV connected to the standard Apple II video output (through a standard RF Modulator), the other a black and white video monitor connected to the VIDEOTERM board. This allows simultaneous displays of 24 lines of text, each line containing 80 characters, and full high resolution, color graphics or another 24 lines of text, each line containing the Apple II standard of 40 characters.

The large chip in the middle of the board is the CRT Controller (CRTC) chip. Above it is the EPROM (erasable programmable read-only memory chip) which contains the current optional character set which the board may display. By switching this EPROM with another, the optional character set may be changed. The board comes equipped with the standard ASCII character set in a second EPROM located below and to the right of the long CRTC chip. The Character Generator chip, located above the CRTC and to the right of the optional character set EPROM, does the actual work of creating the display character. The VIDEOTERM board is described more fully in the Hardware Operation chapter starting at page 6-1. A labelled photograph and a complete board schematic drawing are included as Figures 10 and 11, respectively.

At the bottom right of the board, a part of the board protrudes and has many parallel electrical contacts printed on it. This is the expansion slot interface connector. It is this part of the board

which will be pushed into the Apple II's expansion bus slot to install the VIDEOTERM. You should avoid touching the connectors with your fingers as this may impair the quality of electrical contact. In general, hold the card by its edges when examining it and grasp it firmly by its upper corners when installing or removing it from the Apple II.

VIDEOTERM Features

The VIDEOTERM Board offers you a great many features, some of which are only found on more expensive video display terminals. A complete list of all features is given below. At the end of each description, a manual page reference is given so that you may immediately read more concerning that feature. This allows you to use this section as a cross-index to the more detailed instructions and information which follow.

- <1> 80 Character columns by 24 character lines are displayed at once. The number of lines is changeable to 18. You will definitely want to use the 18 line mode if you have purchased the optional 7 by 12 character matrix EPROM (pages 3-3 to 3-4).

- <2> Text is printed in upper and/or lower case at your discretion (page 3-5). All 96 ASCII display characters are available, as are some of the control characters and a set of graphics characters (Table 2, page 3-4).

- <3> All text character entry is done directly using the Apple II's keyboard. A "CTRL-A" keystroke sequence is used to shift from upper to lower case, and from lower to upper case (page 3-5). Lower case letters are stored internally as true lower case and do not have a "CTRL-A" embedded with them. Alternate entry keystroke sequences are needed to access some of the VIDEOTERM features. These are all fully defined herein (pages 3-6 to 3-10).

- <4> You have direct screen cursor control in Apple's Basic languages using the familiar ESCape key sequences (pages 3-8 to 3-9). In Pascal, cursor control is the same as the Pascal defaults and may be controlled using GOTOXY (pages 3-9 to 3-10 and 4-28).
- <5> The VIDEOTERM board is completely compatible with Pascal. You will not need any software 'patches' to make the board work right the first time, every time (page 4-4). Applesoft Basic and Integer Basic usage requires some slight modification to existing user programs and some precautions in writing new programs that access the VIDEOTERM, but these are well-defined and have been kept to a minimum. Such constraints are fully described (pages 4-2 to 4-4).
- <6> Both Basics are listed on the VIDEOTERM using all 80 columns. Keywords are not split and you may start or stop listings by using the "CTRL-S" entry just like the Apple Autostart ROM (page 3-8).
- <7> The VIDEOTERM board generates an almost immediate response to all inputs. The effective transfer rate between the computer and the display is extremely high, approximately 12,000 BAUD. Speed is enhanced because there is no need to encode the signal into a standard parallel or serial interface format. A very quick screen response is evident in all text printing and scrolling.
- <8> The VIDEOTERM board follows all OEM specifications as issued by Apple Computer, Inc. This guarantees that your board will be fully compatible with all

current and future Apple II peripherals (pages 3-1 and 4-30 to 4-33). The economy minded design of the board ensures that the VIDEOTERM board power draw will be low, further reducing peripheral conflicts.

<9>

The board is compatible with the Apple Serial Interface board, the CCS Asynchronous Serial Interface board, the D. C. Hayes Micromodem II (using optional customized firmware available from VIDEX), the Microsoft Softcard, and many other peripherals that allow interaction with a video display terminal (page 4-33ff). VIDEOTERM is compatible with the EasyWriter Professional Word Processing System, the Apple PIE editor and other word processors available for the Apple II (page 4-30). With only slight modifications, you will find that most software will work excellently with the VIDEOTERM. And the board is compatible with the VIDEX KEYBOARD ENHANCER, allowing direct lower case text entry from the Apple II keyboard (pages 1-11).

<10>

The VIDEOTERM board allows you the option of displaying, either through keyboard or software control, a set of user defined or predefined graphic character sets, in addition to the standard 96 ASCII display characters. Although more limited than the Apple high resolution graphics, many interesting graphical displays can be generated in this fashion. Using the Mountain Hardware ROMWriter (or other EPROM programmer) the user can create any desired graphical or character set (page 4-35ff).

- <11> VIDEOTERM in no way interferes with the memory-mapped graphics display of the Apple II itself (page 5-12 to 5-14). You may thus generate graphical output on either of the two high-resolution graphics pages, or display text data on the direct Apple II video monitor and also have a full page of text and/or VIDEOTERM graphics symbols displayed on your black and white monitor.
- <12> Optional hardware modifications may be made to the VIDEOTERM. These allow use of a 2708, 2716 or 2758 EPROM for the optional character set, setting the entire screen to inverse video (black characters on a white field), or using the characters eighth bit to invert that one character (the cursor is lost in this last option). These hardware modifications are simple and fully described herein (pages 6-4 to 6-8).
- <13> The VIDEOTERM cursor is fully programmable in size and may be set to flash at one of two different rates (page 5-8).
- <14> You may simultaneously display on the VIDEOTERM text that is being sent to a printer (pages 4-9 to 4-13). This software may be modified to allow you to examine what your printer will print before actually doing so.

Apple II Hardware Prerequisites and Options

To fully use all the features and capabilities of the VIDEOTERM board, you should have the following pieces of equipment. However, any Apple II or Apple II Plus with at least 16K of RAM will work, even if the VIDEOTERM is your only Apple II peripheral.

- (1) An Apple II or Apple II Plus, with at least 16K of Random Access Memory.
- (2) A black and white video monitor. We have found the Leedex video-100 monitor and the Sanyo monitor to be excellent monitors for use with the VIDEOTERM. Any monitor that can handle at least a 12 mH bandwidth is acceptable. We have even heard of use of the VIDEOTERM with a TI Color monitor, but the use of Color monitors is not recommended.
- (3) Optionally, an RF Modulator linked to a Color TV to use for graphics displays, additional text displays and as the monitor when the system is first turned on.
- (4) Optionally, at least one, and as many as six, disk drives for full system utilization.
- (5) Optionally, an Apple Language card. The 80 character per line VIDEOTERM screen display format is especially useful with Apple Pascal (or the Softcard).
- (6) Optionally, a VIDEX Switchplate assembly may be added to allow easy use of a single monitor for both Apple II standard video output and VIDEOTERM output.

- (7) Optionally, a VIDEX KEYBOARD ENHANCER for full text entry, both upper and lower case, direct from your Apple II keyboard. This allows access of nine new characters and operates in three different modes.

- (9) Optionally, a ROMWriter or other EPROM programmer for creation of user defined character and graphic sets.

INSTALLATION AND CHECKOUT

How to Install the VIDEOTERM Board

The VIDEX VIDEOTERM consists of two parts: the VIDEOTERM board itself and a connector from the board to the video monitor. An optional product, called the VIDEX Switchplate assembly is also available. The VIDEX Switchplate assembly has its own attached jumper cable that replaces the simple standard connector. If you have installed various Apple II peripherals before, then you should scan these instructions, examine the photographs, follow the checklist at the end of this section as you install the board, and then proceed directly to the Checkout section, page 2-9. If you have never installed a peripheral card in the Apple II expansion slots, then carefully read the following explanation through completely at least twice before attempting the installation. After the detailed explanation, there is a short checklist, page 2-8, to follow when installing the board.

To orient you as to how the board appears when installed, a photograph of the completed installation is included as Figure 1. The view shows the inside of the Apple II with the completed installation, including the Switchplate. Examine these photographs carefully before installing the board and again after installation but before turning on your computer's power switch.

VIDEX CAN ASSUME NO LIABILITY OR RESPONSIBILITY FOR DAMAGES CAUSED BY INCORRECT VIDEOTERM INSTALLATION!

So please double check all connections before you power up the system.

In the following instructions, it is assumed that you are seated at your Apple II, with the

keyboard directly in front of you as if you were about to type. You should clear the top of the Apple II so that you can easily open the computer case and install the board.

- (1) Turn the power switch OFF. The power switch is located at the rear of the Apple II near the power cord connector. It is imperative that this be done, as permanent damage may be done the VIDEOTERM board, the Apple II Motherboard and/or any of the other peripheral boards that may be plugged into the expansion bus at the time. It is much more safe and sure to also completely detach the power cord from the Apple II. That way, it is impossible to accidentally have power supplied to the computer before you are ready.

- (2) Remove the cover from the Apple II. Grasp the cover under its rear lip at each corner using, one hand at each corner, and pop the cover loose from its fasteners. Then pull the cover

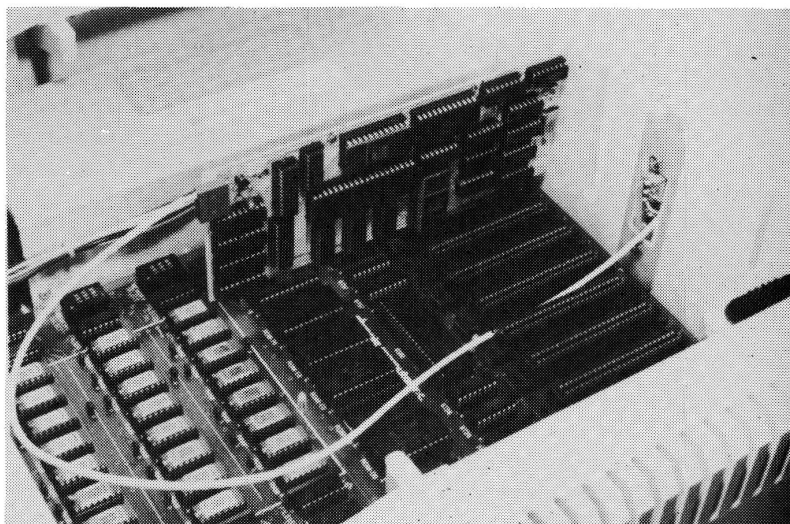

Figure 1: Board Installed in System: Interior View

directly out toward the rear to avoid possible prying on the keyboard. When the cover is free, lift and remove it from the Apple II.

- (3) Inside, covering almost the entire bottom of the computer case, is the green PC Motherboard of the Apple II. Across the rear of the Motherboard is a row of 8 connectors or expansion slots. It is into one of these slots that you will install the VIDEOTERM board. The leftmost slot is slot #0 and the rightmost slot is #7, with the other slots numbered sequentially between the two. Slot #0 should contain your Basic firmware card, containing either Applesoft or Intger Basic, or the Apple Language card. Slot #6 should be reserved for use with the Apple Disk II controller card. The VIDEOTERM board may go into any of the other slots, but it is strongly recommended that it be placed in slot #3, as this is the slot that Pascal expects a terminal to be located in. Standard Apple II software will undoubtedly be written with this consideration in mind, so it is probably best just to use slot #3 right from the start. However, there is no penalty for not using this slot and complete information regarding use of the other slots is given herein. All examples will assume that the VIDEOTERM board has been placed in slot #3.
- (4) Attach the optional VIDEX Switchplate assembly, if you have one, to the outside of the Apple II case in one of the notches cut into the case for that purpose. Any notch may be used, since the connector, which will attach to the VIDEOTERM board, is of sufficient length to reach the board regardless of the location of the installation slot. To attach the VIDEX Switchplate assembly, loosen the two screws (you should

not completely remove them as this will make installation a little harder), separate the two PC boards of the assembly and slip the assembly into a notch. The plate of the assembly which has the switch and two video I/O ports should go on the outside while the board with the VIDEOTERM connector should go on the inside. Orient the Switchplate assembly so that the ports are on the bottom and the switch is on top. Center the Switchplate in the notch and clamp it into place by tightening the two screws on the Switchplate assembly.

- (5) Position the VIDEOTERM board's protruding expansion slot interface connector directly over the chosen expansion slot. The card should be aligned vertically and not twisted in any manner. Holding firmly onto the corners of the board, push the expansion interface connector into its slot. Check that

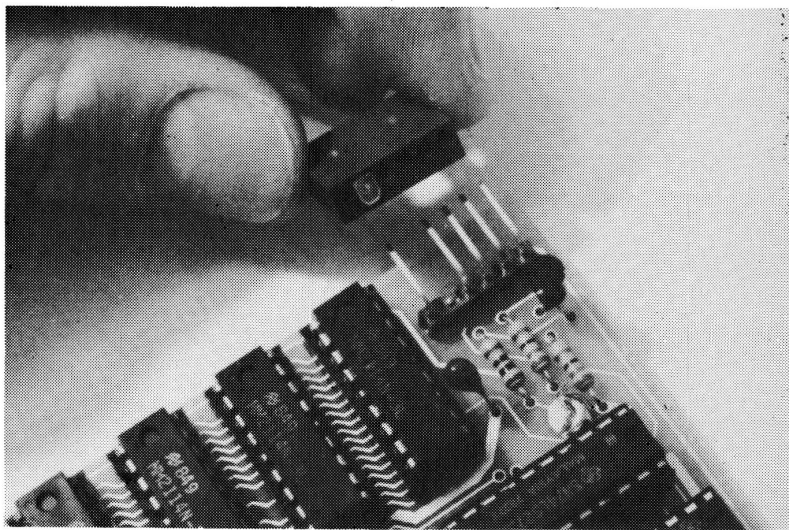

Figure 2: VIDEOTERM Switchplate Assembly Mating with the VIDEOTERM Board

the board is firmly pushed all the way into the slot by rocking it a bit. Make sure that the board has not been tilted down toward the center of the Apple II, as this could result in incomplete connections with the expansion bus (probably with disastrous effects when the power is turned on).

- (6) Attach the enclosed connector to the five video output takeoff prongs on the board as shown in Figure 2 (this connector also slides onto the light pen prong). If you have the VIDEX Switchplate assembly, attach its connector to the VIDEOTERM board in exactly the same manner. The standard connector will not be included if you have also purchased the VIDEX Switchplate assembly. Note that the positioning of the 5 prongs and the design of the connector makes it virtually impossible to connect the two incorrectly.
- (7) Attach your video monitor to the VIDEOTERM by plugging the male end of the video monitor input plug into the female plug on the enclosed connector. If you have the Switchplate assembly, plug your video monitor male plug into the female plug on the outside of the Switchplate assembly. It should go into the upper of the two I/O video ports, the one labelled M for Monitor.
- (8) If you are using the optional VIDEX Switchplate assembly, then you should use a separate standard double-ended male RCA audio cable to connect the lower video monitor input port on the Switchplate assembly (labelled A for Apple) to the Apple II's video monitor output port. The Apple II's port is located next to the cassette I/O ports on the rear of the Apple II. Figure 3 shows the completed assembly of the VIDEX Switchplate assembly and

its connections from a back exterior viewpoint. Flip the switch on the Switchplate to the right position (assuming that you are still seated facing the keyboard) so that you will be sending PR#0 output to your video monitor. This will assist in checking out the VIDEOTERM board as you can tell if your video monitor is working when you turn on your Apple II. If you have Apple Language card, you need not make this connection and you should place the switch on the VIDEX Switchplate assembly in the left position. Actually, if you run just Pascal, you will not need the VIDEX Switchplate assembly but can make do simply with the enclosed, less versatile, standard connector. However, you will find this less than convenient when using either Basic language.

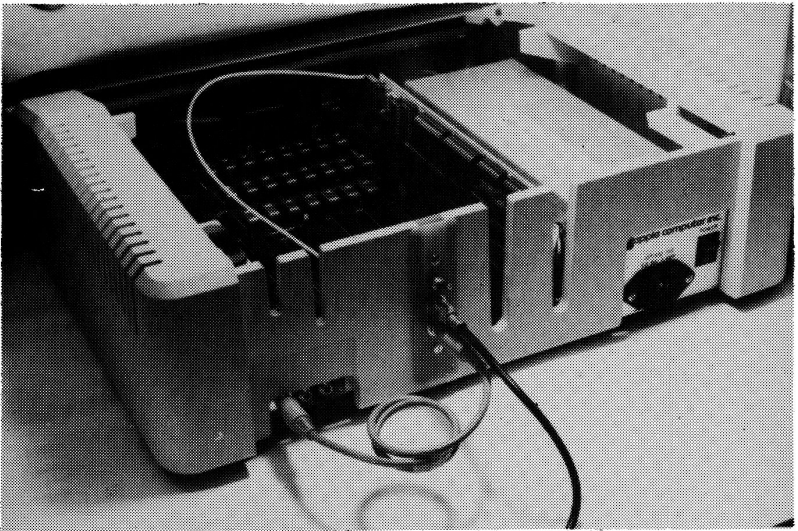

Figure 3: Board Installed in System: Exterior View

- (9) Carefully replace the Apple II cover. At the same time, press down firmly on both rear corners of the lid to resecure it.
- (10) Reattach the power cable and turn on the power switch located on the back of the Apple II.

Installation Checklist

You are now ready to proceed to the Checkout section, page 2-9. To assist you in the actual installation, you may wish to use the following outline as a checklist.

- (1) Turn OFF the power switch and unplug the power cord.
- (2) Remove the cover.
- (3) Insert the VIDEX Switchplate assembly, if you have it, into a notch and tighten its clamp.
- (4) Insert the board into the chosen expansion slot.
- (5) Attach the enclosed connector to the 5 takeoff prongs on the board. If you have it, attach the VIDEX Switchplate assembly's connector to the VIDEOTERM board instead of the connector. (Note that the standard connector is not included if you have purchased the VIDEX Switchplate assembly.)
- (6) Connect your video monitor input plug to the appropriate output plug depending on your use of the enclosed connector or the VIDEX Switchplate assembly.
- (7) Connect the Switchplate assembly to the Apple II's video monitor output port using a separate double-male audio plug. Place the switch in the right position (left if you have Pascal).
- (8) Recheck all connections. Replace and resecure the cover.
- (9) Plug in the power cord and turn on your Apple II!

Checkout

Naturally, the first thing that you will want to do is verify that the VIDEOTERM board is working correctly and that all of its features operate as described. This section will tell you how to make sure that the board is operating normally, make minor adjustments and fix minor errors, or diagnose serious hardware problems which would justify contacting us. All boards are tested before sale, but problems can arise with anything, electronic or otherwise.

A. How to Verify Correct Performance

Verification of board performance will be discussed by type of Apple II system configuration. We need to discuss each language and how the Autostart ROM presence or absence affects the checkout. We will start with a standard Basic Apple II system utilizing one of the two Basic languages. Before we try the board using one of the Basics, however, we will use the Apple II Monitor to do some initial adjustment.

When you turn your system on, it should beep and fill the screen with question marks and/or other symbols and an asterisk with a flashing square cursor next to it will appear near the lower left corner, indicating that you are in the Apple II Monitor. The Monitor's capabilities are described at length in the Apple II Reference Manual. Suffice it to say here that the Monitor is very powerful and you may adequately verify the VIDEOTERM board's correct response from here with a few simple tests.

If you have the Autostart-ROM installed in your Apple II, the probable condition with the Apple II-Plus, you will see

APPLE II

at the top center of your screen. If you have the Disk II system, it will automatically be turned on and a copy of the DOS will be written into your Apple's RAM. Your "HELLO" program that you "INIT"ed the diskette with will be loaded and run. Without the Disk II peripheral, your computer will simply go into either the Applesoft or Integer Basic language, depending on which language is set as the default. (The default language is the one in the Apple II in its Motherboard sockets \$D8 to \$F8, or on your Applesoft or Integer Basic card depending on its switch position.) Once you are in either language, type

CALL -154 (CR)

and you will be placed in the monitor mode.

If you have the standard Monitor ROM, initialize your disk operating system (if you have one), as this will make some of our later tests a little faster. You do this, of course, by typing "6 CTRL-P", where the hyphen indicates that you hold down the Control key while depressing the P key. Naturally, you will terminate all your responses to the Apple II by striking the Return key. After your disk drive finishes whirring, return to the Monitor by pushing the Reset button.

Now, no matter your system configuration using the Basic languages, you are ready to activate the VIDEOTERM board. Type "3 CTRL-P", if you have the board in slot 3. If not, type "n CTRL-P", where n is the number of the slot that you have placed the board in. Flip the switch on the VIDEX Switchplate assembly to the left position. Asterisk should be visible on the left side of the monitor display with a flashing cursor next to it. Reenter either Basic by typing

*3DOG (CR)

and ask for a "CATALOG". If you don't have a Disk II system, then reenter either Basic by typing "CTRL-B" and fill the screen with characters by depressing any alphanumeric key and, while depressing it, hold down the Repeat key for a few seconds. You might want to pause at this time and fine adjust your video monitor since your screen should now be almost full of characters. (With Disk II, try to CATALOG a full diskette so that you can see characters down the entire left side of your screen.) If everything is proceeding smoothly, load and list a Basic program. If you have both versions of Basic installed, try typing "FP" or "INT" as appropriate, and loading and listing a program in the other language. If you don't have the Disk II system, then you can change Basic languages by typing

```
>POKE -16256,0 (CR) (Integer)
?OVERFLOW ERROR IN 60908 (or similar error
                           message will appear on
                           screen)
*"CTRL-B" (CR) (Enter Applesoft)
```

or

```
POKE 49280,0 (CR) (Applesoft)
*"CTRL-B" (CR) (Enter Integer Basic)
```

which will work with or without the Autostart-ROM. Note that "CTRL-B" should not be typed literally, but means that you should strike the B key while holding down the Control key.

If you have a problem at any time, refer first to the Video Monitor Adjustment section, page 2-13, and then proceed to the Fault Diagnosis section, page 2-16 if your question still has not been answered. If everything has been verified, then you may proceed to the Operation section, page 3-1 below.

If you are lucky enough to have either the Apple Language card or the Microsoft Softcard, you will especially enjoy the convenience of the full 80 character wide display and soon be making full use of the lower case capabilities. It is very important that you place the board in slot 3, as this is the normal terminal display interface slot. As explained above, you will not need the VIDEX Switchplate assembly for exclusive Pascal use of the VIDEOTERM board, although it is convenient to have it so that you can use more than one monitor at a time. If you do have the VIDEX Switchplate assembly, make sure the switch is in the left position. Go ahead and activate your system by turning on your Apple II. If by chance you have replaced the Autostart ROM with its non-Autostart brother, then you will have to type "6 CTRL-P". You should see the Pascal announcement in the center of your screen. Proceed to the Video Monitor Adjustment section, page 2-13, until you do have the display.

As soon as you have the Pascal menu prompt line showing, go ahead and try asking for a directory. Feel free to try editing any of your programs. You'll be amazed at the different look your programs and text will have. If you have any difficulties, reread the Video Monitor Adjustment section, page 2-13. If all else fails, consult the Fault Diagnosis section, page 2-16.

B. Video Monitor Adjustment

Let us start with the worst possible case and work toward less dramatic problems.

- <1> No picture at all: Always begin by checking what is simplest to fix and usually makes you feel the dumbest. Is the TV monitor turned on? Is it plugged into the power outlet? Do you know that the video display works? Could it have burned out tubes? Carefully recheck the connections associated with the board, being sure to turn off the Apple II before you do any radical wiggling of the board. Are the connections as described in the section on How to Install the VIDEOTERM board, page 2-1? Is the switch in the correct position on the VIDEX Switchplate assembly? Are all the connections tight? If everything is OK, you should be seeing something on the video display. If the screen is obviously on but you cannot see anything, proceed to the next possibility.

- <2> No visible characters: This is probably due to the screen contrast and brightness controls being slightly out of adjustment. Turn both the contrast and the brightness controls up and see if you notice anything. The next possibility is that the display is shifted slightly off the screen. Look for the horizontal and vertical hold adjustments, which should be located on the front of your monitor. Try twisting each of these slightly in either direction. You should be able to see some type of signal being displayed. Use these two controls to steady and center the display. Once the screen is filled with characters, you might notice that the ones at the top are slightly larger or smaller than the ones at the bottom of the screen. Quite often black and white monitors will have a vertical-size, vertical-line (or linearity) and horizontal width adjustment controls. Usually, these controls will be on the back of the set. Infrequently, they are located inside the cabinet. You should not try to open the cabinet to adjust them, unless you are qualified in servicing TVs. By adjusting these controls, you should be able to obtain a uniform character image over the entire display.
- <3> Persistent rolling: Use the vertical hold adjustment. If you can not correct this, consult the Fault Diagnosis section, page 2-16.
- <4> Bent characters: Try adjusting the horizontal hold adjustment control very slightly in both directions. This problem usually occurs on the top line of the screen.
- <5> Uneven sized characters: Usually caused by incorrect adjustment of the vertical linearity

control. Try varying the setting of it slightly in each direction.

- <6> Indistinct or fuzzy characters: This can usually be corrected by adjusting the focus, fine focus, brightness and/or contrast controls. Characters may be distinctly smeared if your monitor is not terminated with 75 ohms of impedance or if the input gain is too high.
- <7> Overall pointers: One thing to check if you are having problems is the resistance setting on some monitors. The 75 ohm setting should be used. Some monitors have a focus adjustment and this can be used to sharpen or clarify the image. Don't be discouraged. Patiently try various combinations of settings without radically changing anything. You should soon have a clear picture. If you are still having problems, perhaps a friend or the dealer that you bought the board from could help you. If all else fails, please feel free to contact VIDEX directly and we'll be happy to try to help you solve the problem.

Fault Diagnosis

If you are using a standard black and white TV set, we suggest that you modify the TV for use strictly as a video monitor. Don Lancaster's The Cheap Video Cookbook (Howard W. Sams & Co., Indianapolis, IN, 1978) contains the information needed for this transformation on pages 148 to 150.

Our extensive testing of the VIDEOTERM and our experience based on direct feedback after thousands of user hours has convinced us that the VIDEOTERM is generally quite error free. If you suspect a hardware problem, go to your local Apple dealer and ask him to briefly test the various Integrated Circuits on the VIDEOTERM. This can be done by simply swapping in new ICs, an easy task since all ICs are fully socketed and not soldered in place. A bad IC will be at the root of most problems.

Also, have your dealer check the various solder blob connections described in Optional Hardware Modifications, starting on page 6-4. The solder points X1 and X2 should match the IC U5 (see Figure 10) specification, X3 and X4 must match the choice of 2708 or 2716 EPROM, and X5 must match with X6. X7 will be set as normal video when you receive the board. These connections are illustrated in Figure 9 of that section.

In the rare event that your dealer cannot diagnose and correct the fault, return the board postpaid directly to VIDEX in Corvallis, Oregon, for prompt servicing.

OPERATION

Using the VIDEOTERM Board

For those of you who have owned other Apple II peripherals, or Apple compatible peripherals, you will find that the board acts exactly as you would expect when you use the PR#n command (where n is the slot number) to direct printed output to the video display screen instead of the normal PR#0 screen. The board uses the reserved locations for peripheral boards in the Apple's Random Access Memory. These slot dependent location addresses are given in both hexadecimal and decimal notation, along with their usage, in Table 1.

If this is your first Apple II peripheral, you will find it amazingly easy to operate. When you turn on your system, you merely type "PR#3", assuming you have installed the board in slot 3 (PR#n for slot n), and you will see the asterisk, Applesoft or Integer Basic prompt, or the Pascal menu prompt line on the video monitor display screen. You then proceed to use your computer normally, but now you have available, at your fingertips as it were, some powerful new capabilities.

It should be noted that the VIDEOTERM board only uses a few locations in the Apple II's memory. The screen display is memory-mapped out of RAM which is located on the VIDEOTERM board itself. As the Apple II memory addresses used are set aside for that purpose by Apple itself, you are able to use the VIDEOTERM board and have no memory use conflicts with any of your programs, any software that you may have purchased, or with any other peripheral that you may have which has also followed Apple's OEM guidelines.

Table 1

VIDEOTERM Use of Apple II RAM

Addresses used are relative to the slot used for the VIDEOTERM board. Slot n is the slot the board has been placed in. See page 134 in the Apple II Reference Manual for the sets of addresses available as scratchpad Random Access Memory locations.

Description	Hex Addr	Dec Addr
Screen base addr. (low)	\$478 + n	1144 + n
Screen base addr. (high)	\$4F8 + n	1272 + n
Cursor horiz. position	\$578 + n	1400 + n
Cursor vert. position	\$5F8 + n	1528 + n
Pascal char. write loc.	\$678 + n	1656 + n
First line on screen	\$6F8 + n	1784 + n
Power off/leadin counter	\$778 + n	1912 + n
Video set-up flags	\$7F8 + n	2040 + n

The first two storage locations are used to store an address of a location in VIDEOTERM's on-board RAM. This address is where the first character in the line currently being edited/listed is stored. This address will be \$000 to \$7FF, inclusive.

The cursor horizontal position is the current column location of the cursor (0-79, inclusive, from left to right). The cursor vertical position is the current line location of the cursor (0-23, inclusive, from top to bottom). The Pascal write character location is where the Apple Pascal system looks to find the next character to send to a terminal or other peripheral. The first line on screen pointer is used in text scrolling. The various video set-up flags are discussed in the software section, page 5-9.

VIDEOTERM Initialization

When you first activate the VIDEOTERM board with the "PR#3", or when you reset the board to its standard default, you will see 80 characters per line and 24 lines per page or screen, with each character defined as a 7 by 9 matrix within a total 8 by 10 matrix cell, allowing for a slight border around the character.

To change this, simply type "CTRL-Z <params>" where you substitute one of the parameters listed in Table 2 for the angle brackets and their contents. (Pascal users will need to write a short program to send this character sequence to the VIDEOTERM.) For example, if you wanted to use the alternae character set, you would type "CTRL-Z 3". Presto-chango, as they say, and there it is. You should try each of the options and then type a little to observe the different display responses you achieve.

Before we continue, let us mention a unique feature of the VIDEOTERM board. Try using the entry of "CTRL-Z" followed by any control character H through O. You will notice that when you type the control character, you will see displayed the correct ASCII abbreviation for that action. For example, when you type "CTRL-H" (or the back arrow), you will see "BS" displayed as two tiny diagonally-space capital letters in the position of one normal display character.

Return to the Apple Display

When you enter the VIDEOTERM WITH THE "PR#3" statement, the Apple automatically issues a "IN#3" command. However, when you enter "PR#0", THE VIDEOTERM will not reset the "IN" switch by itself. You should thus always follow this command with "IN#0".

Table 2
VIDEOTERM Control Parameters

CTRL-Z Followed by:	Description
0	Clears the 80 column screen and Home's the cursor.
1	Turns off the VIDEOTERM and activates the 40 column screen.
2	Selects the standard 7x9 Character set (the character set in location U20 see page A-4)
3	Selects the alternate 7x9 Character set (the character set in location U17 see page A-4)
CTRL-@ to CTRL-G	Displays one of the set of Mid-resolution graphics characters.
CTRL-Q to CTRL-Underline	Displays one of the set of line drawing graphics characters.
CTRL-H to CTRL-P	Displays small abbreviation of ASCII function (i.e., CTRL-H shows a BS for Backspace)

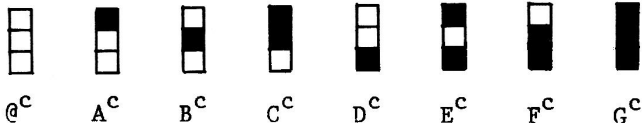

Low-resolution graphics characters: each occupies one character position on the screen display

Upper and Lower Case

You will, of course, want to use lower case right away and no wonder. Lower case is significantly easier to read and recognize than is all capital type, reducing eye strain and reading time. When you first activate the VIDEOTERM board, it will still be in all upper case. To place it in lower case, simply type "CTRL-A". This acts just like a toggle switch or flip-flop in that you are now in lower case mode for as many characters as you wish to type. That is, the next character and all following characters will be uncapitalized.

To do a shift lock, so that you are returned to upper case, type another "CTRL-A". You have flipped the switch, so to speak, and each time that you enter the "CTRL-A" you will go into the mode that you are not currently in. This method of operating the upper and lower case modes is fairly convenient except in the case where you wish to capitalize only the next character. At present, the only way to do this from the keyboard is by typing a sequence such as "CTRL-A Q CTRL-A UITE" to obtain the display 'Quite'. Installation of the VINDEX KEYBOARD ENHANCER will solve this problem, as it allows the use of the shift keys in a manner exactly like that of a standard typewriter keyboard. Note that the lower case characters are stored internally as true lower case. The "CTRL-A" is NOT stored.

Special Key Operation

Most keys will display just as they are typed. However, certain keystroke sequences utilized in conjunction with the Control key, have specific and standard results. These various sequences will be discussed here in detail. In general, they will work the same in all Apple languages, so that by printing that keystroke character sequence to the VIDEOTERM board you will obtain the desired result. Notice that you will not be able to enter all of these directly from your keyboard without the VIDEK KEYBOARD ENHANCER.

As a special note, both the "CTRL-A" and the ESCape key sequences are "swallowed" by the VIDEOTERM board and are not transferred to the Apple II input buffer. All other special key sequences are transferred into the buffer.

CTRL-A: Shift Toggle. The typing of the "A" key CHR\$(1) while holding the Control key down toggles the VIDEOTERM into the other case mode. Thus, if you are in upper case, you will be shifted to lower case, while if you are in upper case you will be shifted to lower case. The case mode remains unchanged until another "CTRL-A" is issued. The "CTRL-A" is not entered into a line of text when typed in from the keyboard. It serves only as a shift toggle.

CTRL-G: Sound the Bell. The typing of the "G" key CHR\$(7) while holding the Control key depressed causes the bell to be sounded. Doing this from the Apple II keyboard directly will cause the computer to sound a small beep from its internal speaker. Try this with the VIDEOTERM board active and with it inactive (i.e., try it before and after you type "PR#3"). The bell will have a

different sound when you have the VIDEOTERM board activated to let you know that it is currently on.

CTRL-H: Non-destructive Back Space function. This operation forces the cursor back one character on the display without destroying the character displayed at the previous location. The "CTRL-H" acts exactly like the single key on the Apple II keyboard labelled with the arrow pointing to the left (found just under the Return key on the right side of the keyboard).

CTRL-J: Line Feed function. This operation causes a line feed to be issued which forces the cursor down to the next line without changing the column position of the cursor. At the bottom of the screen, this will cause the text to be scrolled up one line so that the page display will be altered. A Carriage Return will also have a line feed associated with it.

CTRL-K: Clear to End of Screen function. This operation will clear the text from the present cursor location to the end of the screen. The character at the cursor location will also be deleted but the cursor itself will not move.

CTRL-L: Form Feed function. The issuance of a form feed command will clear the screen entirely of all information displayed, just as if you had ejected a page and started a new one with a printer. This does not destroy any information stored internally in your Apple's RAM, but rather simply starts a new screen. It is important to note here that the "HOME" command in Applesoft and the "CALL -936" statement in either language MUST be replaced with a "PRINT CHR\$(12)" in

Applesoft or "PRINT <CTRL-L>" in either language. See the Apple Language Interactions section in the Software chapter, pages 4-1 to 4-6.

CTRL-M: Carriage Return function. In Pascal, this operation will move the cursor to the leftmost column on the screen without changing its line position. In either Basic language, an automatic Line Feed function (CTRL-J) is also performed at the same time.

CTRL-S: Stop/start text scrolling. This ASCII control character will cause the current text scrolling operation to stop, freezing the display. Text scrolling can be resumed by typing another "CTRL-S" (or any other character).

CTRL-U: Copy character function. This operation, in either Basic, causes the cursor to be advanced one position, copying the character that it was positioned at into the input buffer of the Apple as if it had just been typed from the keyboard. The right arrow, located on the right of the keyboard just under the Return key, performs the same function. This will only work with direct keyboard or program input utilizing the GETLN routine, pages 33-34 of the Apple II Reference Manual. This will not work with the "GET" statement.

CTRL-Y: Home the cursor. This operation causes the cursor to be positioned in the first row, first column without changing the display. It is not the same as the Form Feed function described above.

CTRL-Z: Initialization Lead-in function. Use as the lead-in character for reinitiali-

zation of the VIDEOTERM. The user may choose 18 or 24 lines of text, standard or alternate character sets, display of a control character or normal or inverse video utilizing this function. See Table 2, page 3-4, for a fuller description.

ESCAPE: Edit Control Lead-in function. The ESCape CHR\$(27) key works exactly as it does for the Apple II standard video display. It is used as the lead-in character for an editing command. Follow the ESCape key entry with any of the standard editing keystrokes. These include:

- A -- Advance cursor
- B -- Backspace cursor
- C -- Move cursor down a line
- D -- Move cursor up a line
- E -- Clear to end of line
- F -- Clear to end of screen
- @ -- Clear screen

Note that many of this ESCape key sequences are the same as other Control key sequences mentioned above. Also note that the ESCape key sequences utilizing 'I', 'J', 'K', and 'M' that are available with the Autostart ROM are not usable with the VIDEOTERM.

CTRL-SHIFT-L: Non-Destructive Forward Space function. This operation moves the cursor forward one character on the display without actually copying the character at its previous location to the input buffer. You will not be able to enter this key sequence directly from your keyboard unless you have the VINDEX KEYBOARD ENHANCER installed. Both the Control and the Shift keys must be depressed before striking 'L'. You will still be able to use this function from Applesoft.

CTRL-SHIFT-M: Clear to End of Line function. This CHR\$(29) operation erases all characters from the current cursor location to the end of the present line. Both the Control and the Shift keys be depressed before you strike the 'M' key. Otherwise you will cause a Carriage Return (CTRL-M) to occur.

CTRL-SHIFT-N <x> <y>: Cursor Positioning function. CHR\$(30) This operation is equivalent to the ASCII code GOTOXY. It allows you to directly move the cursor to any specified position on the screen. It is completely compatible with the Apple Pascal GOTOXY function. You follow the "CTRL-SHIFT-N" entry with two numbers which specify the x and y (or horizontal and vertical) screen location that the cursor is to be relocated at. The x and y coordinates are entered as ASCII code sequences above decimal value 32. Try sending various codes to the VIDEOTERM using this function and observe the movement of the cursor in each of the different character cell matrix sizes. Start with "CTRL-SHIFT-N & *" as a start. The upper left corner of the screen is ' ' and ' ' (two spaces). The lower right corner of the screen is '7' and 'o'.

CTRL-SHIFT-O: Reverse Linefeed function. This CHR\$(31) operation forces the cursor up one line without changing its column location. Once the cursor reaches the top of the screen, it will not move anymore. Again, you will need the VIDEX KEYBOARD ENHANCER in order to enter this key sequence directly from your keyboard. It is still available from Applesoft.

SOFTWARE

Now that you have your VIDEOTERM installed and you are satisfied that the monitor is properly adjusted, you are probably very anxious to use it. In the previous chapter you have seen how various key sequences are used to control the VIDEOTERM directly from the keyboard. This chapter contains a number of sample programs, in each of the Apple II languages, to acquaint you with software control of the board. But first we will detail a few necessary changes that you will need to make to some of your existing programs in order to use them with the VIDEOTERM. And we will give the language specific addresses necessary for modifying the VIDEOTERM's internal registers, which are described in the next chapter, starting on page 5-2. We will then describe the use of the VIDEOTERM in conjunction with some other available Apple II peripherals, in particular the use of the ROMWriter to create a new character set.

Apple Language Interactions

The VIDEOTERM has been designed to minimize the interaction it has with user software. Unfortunately, there is some interaction and you will need to make some slight modifications to your current programs, and avoid the use of certain programming statements in the software that you write. This section fully documents those changes.

A. Assembly Language

The only real restriction in Apple Assembly language is to not use those RAM locations, described in Table 1, page 3-2, which the VIDEOTERM uses. This is true regardless of which peripheral you purchase, as Apple Computer, Inc. has set aside these locations specifically for firmware located on

an expansion board. Naturally, you can use these locations either directly in Assembly language, or from other languages, to modify the cursor location, to modify the video set-up flags, to access the start address, in the VIDEOTERM RAM, of the screen start address, and many other things.

B. Integer Basic

You cannot use the "CALL -936" command. You must substitute in its place "PRINT CTRL-L". Naturally, when this is listed, you will see "PRINT", SINCE THE CTRL-L is not printed. You should adopt the trick taught Disk II owners which is to define a character string variable equal to the non-printing character(s) and print that variable. Thus

```
10 L$="<CTRL-L>":REM THIS IS CTRL-L
20 PRINT L$:REM USE THIS IN PLACE OF
   ALL 'HOME' AND 'CALL -936'
   STATEMENTS
```

If you use any "CALL -958" statements, which serve to clear the screen of text from your current cursor position, you will need to replace these with "PRINT CTRL-K" statements. Use a procedure such as that described above to enter these changes into your programs.

If you use any "CALL -868" statements, which serves to clear the present line from your current cursor position, you will need to replace these with "PRINT CTRL-SHIFT-M" statements. Again, use a procedure such as that described above to enter these changes into your programs.

In general, you should be slightly suspicious of any "CALL n" type statements that you use in any of your programs.

You should also be wary of the interaction of

"PEEK" and "POKE" instructions, as these may not work quite as you had planned. However, these should work properly, as should your "VTAB" and "TAB" commands. Expect some minor surprises the first time you run some of your programs using the VIDEOTERM.

Note that graphics statements will not work as expected. Such statements include

```
GR
PLOT x,y
HLIN x,y AT n
VLIN x,y AT n
```

These will be sent to a separate display, such as a color TV, if you have one attached to your Apple video output plug separately from your VIDEOTERM. In fact, even with one monitor, the Apple video display is changed and can be viewed by typing "PR#0". Otherwise, use "REM"s to disable such statements. There is some limited use of graphics on the VIDEOTERM as demonstrated in the example programs, starting on page 4-8.

C. Applesoft

Those restrictions stated above concerning "CALL n" statements for Integer Basic also hold true for Applesoft, and similar corrections should be made to your programs. Of special concern is that the Home command will not work with the VIDEOTERM, so substitute "CHR\$(12)" in its place. Note that the availability of the "CHR\$(n)" function in Applesoft makes it much easier to print the various character sequences that control the operation of the VIDEOTERM.

You should not expect any of the graphics commands to affect the VIDEOTERM, as these will again affect only the normal Apple II display. The commands affected are:

```
GR
PLOT X,Y
HLIN X1,X2 AT Y
VLIN Y1,Y2 AT X
SCRN(X,Y)
HGR
HGR2
HCOLOR=X
HPLOT X,Y
HPLOT X1,Y1 TO X2,Y2
DRAW n AT X,Y
VDRAW n AT X,Y
```

A limited usage of graphics in Applesoft programs is demonstrated in the sample program starting on page 4-21.

The following Applesoft statements will also have no affect on the VIDEOTERM display:

```
FLASH
INVERSE
NORMAL
```

These commands will simply be ignored when executed.

D. Pascal

Your VIDEOTERM will work immediately with the Apple Language card, but there are a few helpful changes you should make. After you install the VIDEOTERM, execute "APPLE3: SETUP" and then change

```
HAS LOWERCASE to TRUE
Set screen width to 80
```

You will now get Pascal prompt lines and all Directory and Edit lines in their full expanded 80 column format. Of course, you had a 79 column display from the moment you initiated your Pascal system with the VIDEOTERM. However, by setting the

screen width to 80, from 79, you will obtain longer Pascal prompt lines.

Program Listing Number One

```
program peekpoke;

type
  trixarray = packed array [0..1] of 0..255;
  trixtype = record
    case boolean of
      false: (address: integer);
      true: (pointer: ^trixarray);
    end;
var
  i, val: integer;
  ch: char;

function peek (addr: integer): integer;
var trix: trixtype;
begin
  with trix do
    begin
      address:= addr;
      peek:= pointer^ [0];
    end;
  end; {poke}

procedure poke (addr, value: integer);
var trix: trixtype;
begin
  with trix do
    begin
      address:= addr;
      pointer^ [0]:= value;
    end;
  end; {poke}

begin {main program}
  page (output);
  writeln ('Peek and Poke program',chr(13));
  ch:= ' ';
  repeat
    if not (ch in ['q','r','w','Q','R','W']) then
      begin
        writeln ('Options:');
        writeln ('      R)read memory address');
        writeln ('      W)rite to memory address');
        writeln ('      Q)uit');
      end;

    writeln (chr(13),'Select.....',chr(13));
    read (keyboard, ch);
    case ch of
      'R','r': begin
          write ('Address to be examined: ');
          read (i);
          writeln (peek(i):10, chr (peek (i)):10);
          writeln;
        end;
      'W','w': begin
          write ('Address: ');
          read (i);
          write ('Value to be poked: ');
          read (val);
          poke (i, val);
          writeln;
        end;
      'Q','q': writeln (chr(13),'That', chr (39),'s all folks.....');
    end; {case}
  until (ch = 'Q') or (ch = 'q');
end.
```

Language Considerations in General

For the most part, you will want to know the memory usage of the VIDEOTERM and how to perform the various operations mentioned in the Firmware chapter, on pages 5-1 to 5-8, in each of the various languages. Sample statements are given in Table 3.

Memory usage in the \$C080+ region of the Apple II addressing space is also of interest. VIDEOTERM usage of this area is also detailed in Table 3. The assignment of the different 16-byte address blocks to the 8 possible expansion slots is given in Table 25, page 82, of the Apple II Reference Manual, available from your Apple dealer. For a discussion of the utilization of the 2K byte firmware memory space, \$C800 to \$CFFF, mentioned in the Apple II Reference Manual on pages 84-85, see the section on VIDEOTERM Memory Mapping, starting in the next chapter on page 5-11. It might be good idea to briefly skim through that section before reading the detailed comments on each of the example programs.

Remember, as noted on page 3-5, that you must execute a "IN#0" following a "PR#0" in order to reactivate the input device correctly. Otherwise, all Apple II display characters will be placed on top of each other.

Table 3: Address Definitions by Language

This table summarizes the addresses to be accessed for device select as described in Apple Language Modifications, pages 4-1 to 4-7, and How to Modify CRTC Registers, page 5-8. These are the language specific address equivalents of each Hexadecimal Apple II memory address. For example, suppose the board is in slot 3. We will enter the number of the register whose value we wish to change first, followed by the value that is to be placed in that register. A total of two bytes of information must be specified. The following sets of statements are equivalent:

```
*COB0: 01 70 (CR)
>POKE(-16208),01:POKE(-16207),112 (CR)
POKE(49328),01:POKE(49329),112 (CR)
```

Slot #	Monitor	Integer Basic	Applesoft
1	\$C090	-16240	49296
2	\$C0A0	-16224	49312
3	\$C0B0	-16208	49328
4	\$C0C0	-16192	49344
5	\$C0D0	-16176	49360
6	\$C0E0	-16160	49376
7	\$C0F0	-16144	49392

Software Examples

The following program listings are offered as examples of how the VIDEOTERM can be controlled by one of your programs. They are not meant to be taken as the best way to use the board, but as indicative of what you can do. Each example will be explained in detail so that you can see just how the program works. Throughout the rest of this chapter, the symbol "(CR)" is used to indicate that you should strike the Return key.

A. Assembly Language

Program Listing 2 gives an example of how the VIDEOTERM can be controlled using Assembly Language. The object of the program is to allow you to view on your monitor the same text that is currently being listed on your printer. To enter this program, go into the Apple Monitor by typing

```
CALL -154 (CR)
```

Then type the following (note that you do not have to type the "*"; the Apple II displays this symbol to let you know that it is ready for more input)

```
*300:48 8A 48 98 48 20 42 03 (CR)
*308:20 00 C8 A9 80 20 ED FD (CR)
*310:A5 36 8D 40 03 A5 37 8D (CR)
*318:41 03 A9 2B 85 36 A9 03 (CR)
*320:85 37 20 EA 03 68 A8 68 (CR)
*328:AA 68 60 8D 7B 06 8A 48 (CR)
*330:98 48 20 42 03 20 C1 C8 (CR)
*338:68 A8 68 AA AD 7B 06 4C (CR)
*340:00 C0 8D FF CF 8D 00 C3 (CR)
*348:A0 30 8C F8 06 A2 C3 8E (CR)
*350:F8 07 60 80 08 08 A0 10 (CR)
```

PROGRAM LISTING # 2

```

2          LST ON
0000:      3 *
0000:      4 BYTE    EQU $678
0000:      5 NO      EQU $6F8
0000:      6 MSLOT   EQU $7F8
0000:      7 COUT    EQU SFDED
0000:      8 *
0000:      9          ORG $300
0300:     10          OBJ $300
0300:     11 *
0300: 48     12 START   PHA          SAVE REGISTERS
0301: 8A     13          TXA
0302: 48     14          PHA
0303: 98     15          TYA
0304: 48     16          PHA
0305: 20 42 03 17          JSR SETREGS   SET-UP FOR ENTRY INTO C800 ROM
0308: 20 00 C8 18          JSR $C800    INITIALIZE VIDEOTERM
030B: A9 90     19          LDA #$80      TRANSMIT FAKE CHARACTER TO PRINTER
030D: 20 ED FD 20          JSR COUT
0310: A5 36     21          LDA $36      STORE OLD OUTPUT VECTOR
0312: 8D 40 03 22          STA JMPADR+1 INTO A JMP OPERAND
0315: A5 37     23          LDA $37
0317: 8D 41 03 24          STA JMPADR+2
031A: A9 2E     25          LDA #<OUT1   SET UP NEW OUTPUT VECTOR
031C: 85 36     26          STA $36
031E: A9 03     27          LDA #>OUT1
0320: 85 37     28          STA $37
0322: 20 EA 03 29          JSR $3EA    SWAP IN DOS OUTPUT VECTOR
0325: 68        30 DONE    PLA          RECOVER REGISTERS
0326: A8        31          TAY
0327: 68        32          PLA
0328: AA        33          TAX
0329: 68        34          PLA
032A: 60        35          RTS
032B:          36 *
032B: 8D 7B 06 37 OUT1    STA BYTE+3   SAVE BYTE TO OUTPUT
032E: 8A        38          TXA          SAVE REGISTERS
032F: 48        39          PHA
0330: 98        40          TYA
0331: 48        41          PHA
0332: 20 42 03 42          JSR SETREGS   SET-UP FOR ENTRY INTO C800 ROM
0335: 20 B3 C8 43          JSR $C8B3   OUTPUT BYTE TO VIDEOTERM
0338: 68        44          PLA          RECOVER REGISTERS
0339: A8        45          TAY
033A: 68        46          PLA
033B: AA        47          TAX
033C: AD 7E 06 48          LDA BYTE+3   OUTPUT BYTE TO PRINTER
033F: 4C 00 C0 49 JMPADR   JMP $C000    THIS ADDRESS WILL BE CHANGED
0342:          50 *
0342: 8D FF CF 51 SETREGS   STA $CFFF   TURN OFF CO-RESIDENT ROMS
0345: 8D 00 C3 52          STA $C300   SELECT CO-RESIDENT ROM IN SLOT 3
0348: A0 30     53          LDY #$30   SET UP THE NO INDEX
034A: 8C F8 06 54          STY NO
034D: A2 C3     55          LDX #$C3   SET UP THE CN INDEX
034F: 8E F8 07 56          STX MSLOT
0352: 60        57          RTS
0353:

```

When you have finished entering these values, type

*300.357 (CR)

This will cause a copy of what you have entered above to be displayed on your video screen. Carefully double-check your entry to make sure that it is the same. You can also type

*300L (CR)

This will cause the Apple to display a listing like that in Program Listing 2, except that no comments will be written by the Apple II disassembler. To continue the listing, type

*L (CR)

Repeat this last entry once more to finish your listing. The important entries are the actual hexadecimal operation codes that are displayed to the left of the Assembly language operation codes, since some of the symbols, such as COUT will not be displayed.

There are several alterations you will have to make if you have installed the VIDEOTERM in some slot other than 3. Substitute

*347:Cn (CR)

*34E:Cn (CR)

WHERE N IS THE SLOT NUMBER IN WHICH THE VIDEOTERM has been placed. Also

*349:<8+n>0 (CR)

is necessary. Note that B0 would be entered if in slot 3, C0 if in slot 4 and so forth.

Notice the two instructions using "BYTE+3" in

the listing at locations \$32B and \$33C, respectively. These must be changed to the equivalent of "BYTE+n". Do this by using Table 1 to calculate the new value to be placed at locations \$32C and \$33D. Note that the same values will be placed in each location. Assuming that the VIDEOTERM has been placed in slot 5, then we would calculate

$$\$678 + n = \$678 + \$5 = \$67D$$

and we would type

```
*32C:7D (CR)
*33C:7D (CR)
```

This completes the necessary changes in the program for use with the VIDEOTERM's changed location. You should save this routine onto your diskette or cassette. The routine starts at \$300 and has a length of \$58.

In order to use the routine from either Basic language, enter the following into your program

```
PR#p:CALL 768
```

where p is the slot number that your printer is in (also true below).

In order to test the program, simply enter the one-line program (again, using either Basic, but using Integer Basic here as an example)

```
>10 PR#p:CALL 768:END
>RUN
```

Note that even with the Apple Disk you should enter the program as above. Do not enter (where D\$ is a "CTRL-D")

```
>10 PRINT D$;"PR#p":CALL 768:END
```

as this will not work with the VIDEOTERM.

If you do not have the Apple Disk Operating System (DOS), then you should modify the above Assembly Language program by typing

```
*322:EA EA EA
```

These are NOP (No Operation) codes, and they effectively keep the program from accessing DOS to obtain its output address (also called a vector, since it points to a location which itself contains an address). The 6502 microprocessor will simply ignore this instruction and execute the following one. This program modification should be done before saving your copy of the program.

An important reminder is that the printer is the controlling device, not the VIDEOTERM, so that some of the VIDEOTERMs control key sequences will not be activated, but printer control characters will be.

B. Integer Basic

Program Listing 3 is an example of how to place a character on the screen in a desired location using an Integer Basic program. This program will fill the video display with the entire character set, with each line repeating the set but shifted over one column so as to make a diagonal pattern. The screen is filled in a random order, so that it takes several minutes to completely fill the screen, but the display is about 80% complete after one minute. This program is an excellent one to use to help fine tune the adjustment on your monitor.

Before we begin, it might be helpful if you briefly review the discussion of how the VIDEOTERM's on-board RAM maps into the display and how it is accessed by internal Apple II addresses.

Essentially, the on-screen location of a character corresponds to its address in the RAM which is located on the board. A unique set of addresses in the Apple II allows you to access the VIDEOTERM RAM directly, but this same set of Apple II addresses can specify any one of 4 different address locations on the VIDEOTERM. A technique called "paging" is used, and by determining which page we are using (each page being 512 bytes long), we have determined where the character we are writing is really going in the VIDEOTERMs RAM, and therefor, on the display screen.

Let's take a look in detail at how the program operates. Line 10 defines several Basic variables. START is the address, in decimal, of the memory location in the Apple II where a VIDEOTERM address is stored. This VIDEOTERM address, in turn, is defined as the location where the first character of the first line on the screen is stored (see $\$6F8 + n$, Table 1). This is needed since the actual memory location in the on-board RAM of the first display line on the screen varies. By adding the SLOT value to START we will obtain the correct Apple II address. This is done in line 15, with the result being assigned to the variable LINE1.

DEVICE is the name of the variable assigned the value of the base address of the 16-byte group of slot dedicated addresses reserved for the various peripherals. (Again, see the Apple II Reference Manual, page 82.) The value -16256 is equal to $\$C080$ or 49280. By adding SLOT times 16, we get the value assigned to LINE2 in line 15. Note that if $SLOT = 3$, then $LINE2 = -16208$ or 49328 or $\$C0B0$, exactly the values we see in Table 3 for slot 3 usage! Because we have the VIDEOTERM in slot 3, $SLOT = 3$ in line 10.

The value for SCREEN is equivalent to 53224 or $\$CC00$, the Apple II address of the first character of the current active page of VIDEOTERM Random

PROGRAM LISTING # 3

```
>LIST
10 START=1784:DEVICE=-16256:SLOT=3:SCREEN=-13312:PLOT=100
15 LINE1=START+SLOT:LINE2=DEVICE+SLOT*16
20 X= RND (80)
30 Y= RND (24)
40 BYTE=(X+Y) MOD 96+32
50 GOSUB PLOT
60 GOTO 20: REM

100 ADDRESS=(X+Y*80+ PEEK (LINE1)*16) MOD 2048
110 PAGE=ADDRESS/512
120 SELECT= PEEK (LINE2+PAGE*4)
130 POKE SCREEN+(ADDRESS MOD 512),BYTE
140 RETURN

>
```

Access Memory. See the next chapter, page 5-11, for an explanation of how the addresses \$CC00 to \$CFFF are used in writing characters to the VIDEOTERM memory. For now, just note that this is the base address for VIDEOTERM RAM access.

Lines 20 and 30 assign a random integer number between 0 and 79 to X and a random integer number between 0 and 23 to Y. These correspond to the column (X) and the row (Y) that we will put the character in on the display screen. In line 40, we then use the screen position to determine which character will be printed there. The sum of X and Y is taken modulo 96, which just means that a value between 0 and 95 will be chosen depending on the actual value of the sum. Then the value 32 is added. This value is then assigned to the variable BYTE. If you look at the ASCII symbols defined in the Appendix Table, you will see that this limits us to choosing an ASCII character whose decimal value is between 32 and 127, inclusive. This includes all the standard display characters, but excludes the control characters.

Line 50 directs program control to the PLOT subroutine, starting at program line 100. Finally, line 60 returns us to line 20 to repeat the process. Note that the REM statement contains a "CTRL-J" to space the PLOT subroutine down one line for easier reading.

Line 100 starts the PLOT subroutine. A value is calculated and assigned to the variable ADDRESS. This value is calculated as follows. First, the on-screen character location is calculated as a number between 0 and 1919 ($X + Y * 80$). The on-screen character locations are numbered from 0 to 79 on the first line, 80 to 159 on the second, and so forth, to 1840 to 1919 on the twenty-fourth line. This is added to the VIDEOTERM start screen address multiplied by the value of 16. We do this because the start screen address was divided by 16 in the

firmware to save one byte of room.

The resulting number of this process is then taken modulo 2048, since there is only 2K RAM on-board and thus there are only 2048 locations to store information at. This is called "wrap-around" since the character stored at VIDEOTERM RAM address 2047 is followed on the screen by the character stored at address 0.

Line 110 assigns to PAGE the current active page of on-board memory that will be accessed by Apple II addresses in the range \$CC00 to \$CDFF. Then line 120 assigns to SELECT the value stored at the location \$COB0, \$COB4, \$COB8 and \$COBC, depending on the current active "PAGE". The value stored there is of no consequence. The access by the "PEEK" activates the appropriate page. It is important that a "PEEK" access be utilized at this time for that purpose! (It can also be done at an earlier time, but only after the correct address has been calculated.)

Line 130 then writes the actual chosen character, BYTE to the VIDEOTERM memory using a poke. Simultaneously, the character appears displayed on the monitor screen. The address for the POKE is the base address of the VIDEOTERM memory, SCREEN (\$CC00) plus the page-relative address of the character ("ADDRESS MOD 512"). Line 140 is the "RETURN" statement that ends the subroutine.

You might want to play around with the program a little. A faster display of the character set can be obtained if you substitute "FOR" statements in place of the two Random number calls on lines 20 and 30 and "NEXT" statements in place of the "GOTO" statement on line 60. You can also change line 40 to print any set of characters that you would like to see. Try modifying it to display the graphics character set located at "CTRL-P" to "CTRL-SHIFT-0".

PROGRAM LISTING # 4

PR#0
>LIST

```
5 DIM A(3):A(0)=1:A(1)=2:A(2)=4:A(3)=8
10 START=1784:DEVICE=-16256:SLOT=3:SCREEN=-13312:PLOT=100
15 LINE1=START+SLOT:LINE2=DEVICE+SLOT*16
20 FOR X=0 TO 79
30 FOR Y=0 TO 71
50 GOSUB PLOT
60 NEXT Y,X: REM

100 ADDRESS=(X+Y/3*80+ PEEK (LINE1)*16) MOD 2048
120 SELECT= PEEK (LINE2+ADDRESS/512*4)
130 ADD=SCREEN+(ADDRESS MOD 512)
147 R=Y MOD 3
155 BYTE= PEEK (ADD) MOD 8
157 STRIP=A(R+1)
160 POKE ADD,BYTE/STRIP*STRIP+3*BYTE MOD A(R)+A(R)*COL
180 RETURN
```

>

Program Listing 4 follows the same pattern as the previous example. The object of this program is to demonstrate the writing of one of the graphics characters in the range "CTRL-Z CTRL-@" to "CTRL-Z CTRL-G" as explained in Table 2. Let us examine this example in detail.

Line 5 assigns to the elements of the array A the corresponding powers of 2. Thus, $A(0) = 1$, $A(1) = 2$, $A(2) = 4$, and $A(3) = 8$. These will be used later in the program rather than an equivalent calculation of the power of 2, because access of an array element is much faster than the exponentiation operation.

Lines 10 and 15 are similar to those lines in Program Listing 2. Lines 20 and 30 set up a pair of "FOR-NEXT" loops. Notice that in the current order, the screen will be filled a column at a time. To change this, simply reverse the order of the two lines and change the "NEXT" statement in line 60.

Line 40 determines the color of the graphics character to be printed which in this case is color 1 (magenta). This will appear as a white dot on your Black and White monitor. In the listing it is assigned a constant value, but we will change this later. Line 50 calls the PLOT subroutine and line 60 continues the loops. Notice that the order of Y and X need to be exchanged if you change the order of the "FOR" statements. The "REM" statement of line 60 contains a "CTRL-J" to skip a line in the listing.

Line 100 begins the PLOT subroutine. We choose the ADDRESS in the VIDEOTERMs RAM at which the graphics symbol will be placed as in the preceding example. Note that Y must be divided by 3 to obtain a value between 0 and 23, inclusive. Line 120 activates the proper memory page, in a slightly different fashion than was done in line 120 of the

previous example. Line 130 calculates the page-specific address. The following lines require considerable explanation. Before we describe these in detail, let's consider what is happening overall.

We wish to change the entire screen from black to white by changing only one low-resolution pixel at a time. As can be seen in Table 2, page 3-4, each "CTRL-<char>" in the low-resolution graphics character set contains 3 pixels. We will start with the equivalent of "CTRL-@" in character position 0 (first column, first row). We wish to replace it with the symbol corresponding to "CTRL-A" as this changes the color of the first pixel. Then, we will replace that with "CTRL-C", and then with "CTRL-G". This adds, in smooth increments, one pixel at a time in that character position.

Now let's look at the program in detail. Line 147 takes the modulo base 3 of the row variable, Y. Note that the Y indexed "FOR-NEXT" loop runs from 0 to 71. This is because each graphics symbol only occupies one-third of a row! So we must take the row number modulo base 3 to determine which of the 3 pixels at our current location is to be changed to white.

Line 155 gets the contents of the current screen location. This will be a value between 0 and 7, and will correspond to the assigned low-resolution graphics character already there. You will note that if you turn Table 2 on edge, with the page number to your left, that the pixel assignments fall in a normal bit pattern from the values 0 ("CTRL-@"), 1 ("CTRL-A"), and so forth, to 7 ("CTRL-G"). (See bits 0, 1 and 2 for this character group in the ASCII Character Code Chart, page A-1.) Note that no matter which character is actually at that location, a number between 0 and 7 will still be selected.

For example, if your screen was filled with

characters as a result of running the previous example, and you ran this example without first clearing the screen, then the program would detect some character, perhaps a ".". The rightmost three bits add up to 6. Thus, BYTE could be assigned a 6, which it would interpret as a "CTRL-F". We will follow this example as we continue to examine the program.

Line 157 assigns a power of 2 to STRIP based on the value of R. Since R must be 0, 1 or 2, STRIP will be 1, 2 or 4, respectively. In our example, we would obtain 2 for Y = 0, 4 for Y = 1, and 8 for Y = 2. Note that this calculation depends on which of the three pixel we are adding to the display and not the value of any character that might already exist at that location.

At line 60 the actual "POKE" of the character into address ADD is done. The value "POKE" is arrived at as follows. First, the higher order bits of the first three bits of BYTE are obtained by dividing and multiplying by STRIP. In our example, 6 would be divided by 2 ($A(1) = 2$ for $R = 0$, which is always the first value used in any character location due to line 147), and then multiplied by 2, yielding 6. Thus, we have not changed bit 1 or 2 at all by this operation, which is the object -- to leave them undisturbed. This operation, with $R = 0$, clears bit 0. When $R = 1$, we would clear bits 0 and 1, and when $R = 2$, we would clear bits 0, 1 and 2. Then the "BYTE MOD A(R)" instruction gets any previously set bits in this group (i.e., none for $R = 0$, bit 0 for $R = 1$, and bits 0 and 1 for $R = 2$). Following our example, with $R = 0$, we would obtain a 0, since the modulo base 1 is always 0. Finally, the " $A(R) * COL$ " does the actual setting of bit 0. In our example, it will be equal to $1 \times 1 = 1$. Thus, our final "POKE" will be with a value of 7 and we will fill the entire character location with a white square in one jump. This is why the line being drawn on the screen appears to jump faster

down the column when there are other characters on the screen when you start to run the program. If you clear the screen before running, the drawing will be done in a smooth fashion.

On the next pass on this row, the value 7 will be obtained by `BYTE` (all pixels colored), so that with `R = 1`, we will calculate the value of $4 = \text{BYTE} / \text{STRIP} * \text{STRIP}$, $1 = \text{BYTE} \text{ MOD } A(1)$, and $2 = A(1) * \text{COL}$, so that again a 7 will be obtained. You can verify that the same result will occur for `R = 2`.

Now if the display was blank to begin with, for `R = 0` we would obtain the value of 1 to be "POKE"d, for `R = 1` we would obtain 3, and for `R = 2` we would obtain 7. You should verify this by calculating the values for line 160 using `BYTE = 0` to start.

Try modifying this program by substituting "`COL = RND(2)`" at line 40. This will randomly determine if the current pixel should be colored or not.

C. Applesoft

The `VIDEOTERM` is relatively easy to work from Applesoft due to its intrinsic "`ASC`" and "`CHR$`" functions. As an example of how to implement a shift/shift-lock feature under program control using the "`ESC`" key as the shift key, examine Program Listing 5.

Line 5 starts by defining the "`ESC`" key (`CHR$(27)`) to be the shift key toggle. We also set the upper/lower case mode flag, `UL = 1`, indicating that all characters are to be interpreted in the lower case. A value of 2 will indicate that we wish to capitalize only the next character and a value of 3 will indicate that we wish to have all upper case characters until we again type the "`ESC`" key.

Line 8 makes sure that `UL` will always be

PROGRAM LISTING # 5

PR#0
]LIST

```
2 HOME
3 VTAB 23: PRINT "VIDEOTERM IS ACTIVE SCREEN": PRINT CHR$(4);"PR#3"
5 UL = 1:AS = CHR$(27)
8 IF UL = 4 THEN UL = 1
10 GET XS:X = ASC(XS)
15 IF XS = AS THEN UL = UL + 1: GOTO 8
20 ON UL GOTO 30,40,50
30 XS = CHR$(X + (32 * (X > 63)))
40 UL = 1
50 PRINT XS;: GOTO 10
10000 END
```

]]

limited to the values 1, 2 or 3. Line 10 is used to obtain a keyboard character, and then the ASCII decimal value of the character is assigned to the variable X.

In line 15, we test to see if we have received the "ESC" key entry. If we have, then we increment UL and go to line 8 to make sure that UL does not get too large. Thus, if UL = 1 and we get the "ESC" key, then we change to upper case for the next character (UL = 2). If another "ESC" entry follows immediately, then we will go into shift lock (UL = 3). Another "ESC" in a row will leave us in lower case again (UL = 4 --> UL = 1). This functions very much like a normal typewriter.

As soon as we receive any other key entry, we will proceed to line 20. We jump to a location dependent on the current UL value. If in lower case mode, we will go to line 30. Here we take the value X and add 32 to it if the character is a letter, i.e., if its ASCII decimal value exceeds 63. (See the ASCII Character Code Chart, page A-1. We are effectively mapping columns 4 and 5 into columns 6 and 7, respectively.) We emphasize that this is only done when UL = 1.

If UL = 2, then we go to line 40, skipping the lower case conversion. Line 40 sets UL = 1 again, since the first "ESC" key was not followed immediately by another "ESC". If UL = 3, we would proceed immediately to line 50 to print the character just obtained. Note that for any of the "GOTO"s we will "fall through", executing the following instructions, until line 50 sends us back to line 10.

Now let's see how the program works using an example. Enter the program and save it. Now run it. Let's enter the proper combination of characters so that we will see

HELLO out There

displayed on the VIDEOTERM. Start by typing the "ESC" twice. Then type "HELLO ", one letter at a time. UL will now equal 3. Enter another "ESC" and type "OUT". The value of UL was changed to 4 and then to 1 before "OUT " was typed, so we will see the word displayed in lower case. Finally, type the "ESC" key once and type "THERE". The program will type the "T" in upper case and the rest in lower case. UL was set equal to 2 for "T", and then back to 1 at line 40.

You might want to incorporate this technique into some of your own programs. The character string could be appended to another one until a full line was obtained and then it could be saved as part of a text file. The technique can also be used with Assembly language to interface your word processor with the VIDEOTERM.

Program Listing 6 gives an example of cursor positioning in Applesoft. The program is simple and straightforward. Line 5 prints a "CTRL-D". Line 10 creates a string of 8 backspaces. Then the program will request that you enter an X and Y coordinate of a character location in the range of 1 to 80 for X and 1 to 24 for Y. Note that this is different than how the columns and rows are actually numbered, but it is easier to count that way. Enter the values on one line, separated by a comma and terminated by striking the Return key.

Line 35 positions the cursor to the appropriate location and line 50 displays the Rub-out character (CHR\$(127)) there. Then line 50 returns us to line 20 for input of another pair of coordinates.

While very simple, note that this is generally useful. You should try translating the Integer Basic examples into Applesoft, especially the low-resolution graphics example. That example and

PROGRAM LISTING # 6

```
5 PRINT CHR$(12);
10 FOR I = 1 TO 8:H$ = H$ + CHR$(8): NEXT I
20 VTAB 1: PRINT " ENTER X & Y COORDINATES ";H$;
30 INPUT X,Y
35 PRINT CHR$(30); CHR$(31 + X); CHR$(31 + Y);
50 PRINT CHR$(127)
70 GOTO 20
```

this one can be integrated to yield a simple plotting program. The low-resolution graphics set gives 80 by 72 pixels, almost three times the density of the Apple II's format of 40 by 48 in low-resolution graphics mode.

These listings are patch programs for KEYPRESS, the appropriate one should be run for your version of Pascal with the disk that has SYSTEM.APPLE on it in the drive that is volume #4. In addition to enabling the KEYPRESS function, the type-ahead buffer and system break have also been enabled.

PROGRAM VIDPATCH;

(* This program patches the SYSTEM.APPLE console check routine for version *)
(* 1.0 to allow KEYPRESS, SYSTEM BREAK and type ahead buffers to operate *)
(* with the VIDEOTERM. Darrell Aldrich 10/80 *)

VAR BUF:PACKED ARRAY [0..31,0..511] OF 0..255;

F:FILE;

I:INTEGER;

BEGIN

RESET(F,'#4:SYSTEM.APPLE');

I:=BLOCKREAD (F,BUF,32);

CLOSE(F);

BUF[3,147]:=4;

BUF[3,366]:=234; BUF[3,367]:=234; BUF[3,368]:=234;

BUF[3,202]:=160; BUF[3,203]:=48; BUF[3,204]:=173; BUF[3,205]:=0;

BUF[3,206]:=192; BUF[3,207]:=16; BUF[3,208]:=18; BUF[3,209]:=32;

BUF[3,210]:=111; BUF[3,211]:=216; BUF[3,212]:=234;

RESET(F,'#4:SYSTEM.APPLE');

I:=BLOCKWRITE(F,BUF,32);

CLOSE(F);

END.

PROGRAM VIDPATCH;

(* This program patches the SYSTEM.APPLE console check routine for version *)
(* 1.1 to allow KEYPRESS, SYSTEM BREAK and type ahead buffers to operate *)
(* with the VIDEOTERM. Darrell Aldrich 1/81 *)

VAR BUF:PACKED ARRAY [0..31,0..511] OF 0..255;

F:FILE;

I:INTEGER;

BEGIN

RESET(F,'#4:SYSTEM.APPLE');

I:=BLOCKREAD (F,BUF,32);

CLOSE(F);

BUF[3,389]:=160; BUF[3,390]:=48;

BUF[3,394]:=60;

BUF[3,455]:=173; BUF[3,456]:=0; BUF[3,457]:=192; BUF[3,458]:=16;

BUF[3,459]:=29; BUF[3,460]:=32; BUF[3,461]:=24; BUF[3,462]:=218;

BUF[3,463]:=234;

BUF[4,207]:=3;

RESET(F,'#4:SYSTEM.APPLE');

I:=BLOCKWRITE(F,BUF,32);

CLOSE(F);

END.

D. Pascal

The use of the VIDEOTERM with Pascal is especially easy due to the great flexibility of the language and the Apple Language card operating system. As a quick example, Program Listing 7 shows how to utilize the "GOTOXY" function.

Program XYADDRESS defines three integer variables and a single string variable. I is used as a loop index, and X and Y are, naturally, the X and Y screen coordinates of the desired character location. When the program begins, the string variable S is set equal to "VIDEX" and the screen is cleared. Then each of the letters of S are accessed one at a time by execution of the "FOR" loop. The "CASE" statement is used to assign the actual screen coordinates at which the chosen character will be printed. Then the "GOTOXY" function moves the cursor there, and the Pascal internal "COPY" function is used to acquire the correct character from S and display it on the screen at the cursor location. The next character is then done until the "FOR" loop has been completed.

Enter the program using the Editor, then quit and update your work file. Compile and run it. The program will print "VIDEX" in a V pattern on the screen, starting in column 0, row 1 and ending in column 79, row 1.

You should also review the Program PEEKPOKE, Program Listing 1, for a method of accessing and changing internal memory location values.

PROGRAM LISTING #7

```
(*SL PRINTER: *)
PROGRAM XYADDRESS;
VAR I,X,Y:INTEGER;
    S:STRING;
BEGIN

  S:='VIDEX'; (* INITIALIZES STRING *)
  PAGE(OUTPUT); (* BLANKS SCREEN *)
  FOR I:=1 TO 5 DO BEGIN
    CASE I OF
      1: BEGIN X:=0;Y:=1;END;
      2: BEGIN X:=19;Y:=11;END;
      3: BEGIN X:=39;Y:=23;END;
      4: BEGIN X:=59;Y:=11;END;
      5: BEGIN X:=79;Y:=1;END;
    END; (* OF CASE STATEMENT *)

    GOTOXY(X,Y);WRITE(COPY(S,I,1)); (* USES COPY INTRINSIC STRING FUNCTION *)
  END; (* OF FOR LOOP *)
END. (* OF PROGRAM *)
```

Using VIDEOTERM with Other Software

A. EasyWriter Professional Word Processing System

The EasyWriter, by Information Unlimited Software, is now totally compatible with the VIDEOTERM. Be sure to specify that you own a VIDEOTERM when you purchase EasyWriter, or contact IUS or your Apple dealer for details on how to acquire software updates incorporating full VIDEOTERM utilization. You can now view your text as it will be printed before printing it. The resulting display is much easier to read and on-screen text editing is improved.

B. Apple PIE

The Apple PIE editor, available from Programma International, makes full use of all VIDEOTERM features. Be sure to inform them that you own a VIDEOTERM if you purchase the editor from Programma directly, or from your local Apple dealer, to ensure that you get the new version. Contact Programma directly for information on updating your version of Apple PIE, if you currently own a copy.

C. Others

At present, several other software houses are modifying or creating software for full VIDEOTERM compatibility. If you return the enclosed registration page, VIDEX will keep you informed of new and modified software products as they become available.

Interfacing with Other Peripherals

A. Softcard

The new Softcard by Microsoft utilizes software which, as far as the VIDEOTERM is concerned, looks much the same as the Apple Language card. The installation of the VIDEOTERM card in slot 3 will cause the Softcard to treat your video screen as if it was an ordinary display terminal. You should not have to make any adjustments or changes to the Input/Output routines of the CP/M Operating System. See the Checkout section, page 2-12, and follow the same procedures that you did with Apple Pascal in adjusting your monitor for the VIDEOTERM.

B. D. C. Hayes Micromodem II

The VIDEOTERM and the Micromodem II are compatible.

There are two basic ways to use the VIDEOTERM and the Micromodem together. As a 'dumb' terminal, without any program in memory, or under the control of a communication program. If you are going to use the Micromodem in the dumb terminal mode, it may be advantageous to use the VIDEX Micromodem firmware, which replaces the firmware on the Micromodem board. With our version of the firmware installed the prompts that the Micromodem issues will be sent to the VIDEOTERM's screen. Without our firmware the prompts will be sent to the 40 column display, even if the VIDEOTERM is turned on! It is important to note that there are some changes in the operation of the Micromodem with our firmware installed.

The most important modification is the removal of the self-test feature of the original Micromodem II firmware. Attendant to this change is the removal of the OUTA entry point in the firmware, which was used with the self-test procedure. It is therefore very important to keep your original firmware EPROM in a safe place, as you will need it for testing the unit when you desire. The other changes to the firmware are:

The flashing cursor is no longer removed when a character is received.

In the original firmware, bit 5 of the FLAGS register (\$77B) was unused. It is now used for the VIDEOTERM bit. If bit 5 is set it indicates that the VIDEOTERM board is present and output will be routed to it directly. If it is not set, output will be sent to the normal Apple II display.

Two new Zero Page locations are defined. VIDEXL (\$08) and VIDEXH (\$09) hold the address of the VIDEOTERM output call address. Remember that this first address is called a vector because it points to another location whose contents are of interest. When the VIDEOTERM board is present, output is routed via an indirect jump (hexadecimal operation code 6C, see page 123 of the Apple II Reference Manual) which uses the address stored at VIDEXL and VIDEXH.

To use the VIDEOTERM with the Micromodem the sign on process to a dial on computer network varies slightly. The following illustration shows the correct way to use the Micromodem and the VIDEOTERM together. (This example assumes the VIDEOTERM is in slot 3, the Micromodem is in slot 2, and the VIDEX micromodem firmware installed in the Micromodem II)

PROCEDURE	RESULTS
1) Connect VIDEOTERM	(If the soft switch is not being used)
2) PR#3	Prompt returns
3) IN#2	Prompt returns
4) POKE 1786,0	(To enable lower case display)
5) CRTL-A	MICROMODEM:?
6) CTRL-F	MICROMODEM:BEGIN TERM
7) CTRL-A	MICROMODEM:?
8) CTRL-Q	MICROMODEM:DIAL:
9) type number	MICROMODEM:AWAIT CARR
10) wait	MICROMODEM:CONN

At this point you should be able to sign on to a computer network (such as the Source or Micro-Net) normally, with the display in 80 columns! If you did not have the VIDEX Micromodem firmware the procedure would be the same but you would not have any display on the VIDEOTERM until after step 10. (information on step 4 can be found in the Micromodem manual)

Another popular way to use the Micromodem and the VIDEOTERM together is through the use of a Communications Program.

A good communications program can be invaluable in making the most of your time when connected to another computer. An important thing to look for when buying a communications program is: Compatability with the VIDEOTERM. Although most programs work well with the VIDEOTERM some do not. It is always a good idea to try out a program before buying it to insure that you will have no problems setting up the program before trying to use it.

If you are going to use the Micromodem with a communications program it is important to note that you have NO need for the VIDEX micromodem firmware. In fact some programs, such as Apple Computer's News and Quotes and Dow Jones program will NOT work with the modified ROM. However, most programs will work properly with the VIDEX Micromodem firmware installed in the Micromodem.

The following is a list of communications programs that are known to work with a VIDEOTERM and Micromodem.

ASCII Express 'The Professional'
Transend
Data Capture 4.0 (VIDEOTERM version)
B. I. T. S.
Z Term (for CP/M)

This is in no way a comprehensive list of all the communications programs that work with the VIDEOTERM rather, it is a sampling of programs that are currently available. New programs are constantly being released for the Apple][and should not be overlooked when buying a communications program.

Creating New Character Sets

You may use any 2708, 2758 or 2716 EPROM programmer, although the most common and popular programmer is the ROMWriter available from Mountain Hardware. . The ROMWriter utilizes 2716 EPROMs. You should check the Optional Hardware Modification section, page 6-4 to 6-6, to ensure that your VIDEOTERM is correctly set up for the size of EPROM that you are planning to use. Note that the 2758 should be set up like a 2716.

A. Text

Naturally, you may print all 128 ASCII characters on your video monitor using the VIDEOTERM. However, the expanded character set available on the 2708 EPROM on the VIDEOTERM contains another 64 characters which may be printed

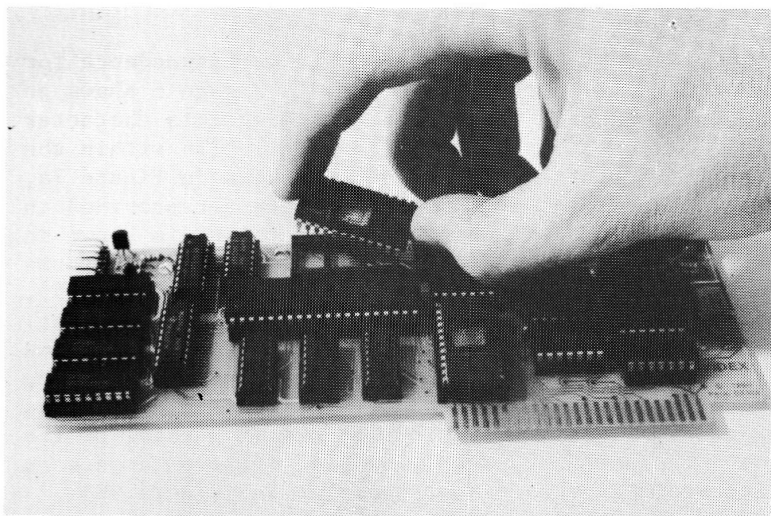

Figure 4: Insertion of Character set EPROM into the VIDEOTERM board

using the keyboard or by printing characters from your running programs. To activate the expanded character set, enter or "PRINT" the "CTRL-Z 3". Return to the standard character set with "CTRL-Z 2". Depending on the EPROM that you have installed, you may have virtually any character font available to you. If you don't have an EPROM installed in your VIDEOTERM, the selection of the expanded character set will simply generate blank white squares.

VIDEX offers a variety of character fonts on 2708 and 2716 EPROMs. Write to us for a current list of available character sets. These EPROMS are easily installed in place of part U-17 in the photograph on page A-4. Figure 4 shows a photograph of the insertion of an EPROM into this location. Be careful when inserting or withdrawing any chip from the board as you can easily bend the pins which may result in their breaking.

Figure 5 shows the keyboard correspondence for the Line Drawing set EPROM. Figure 6 shows an example report form created using this character set. The actual use of character cells within the matrix for this character set is shown in Figure 7a, pages 4-40 to 4-43. The character set provided in your 2716 EPROM Character Generator is shown in Figure 7b, pages 4-44 to 4-51. Several blank forms have been included as Figure 8, pages 4-52 to 4-55, for you to use in creating your own character set. Feel free to photocopy as many of these blank forms as you like. You can program these yourself if you have a 2708 EPROM Programmer for the Apple II. You can even use a 2716 EPROM to obtain a total of 128 new characters by simply resoldering two jumpers on the VIDEOTERM board (see page 6-4 and Figure 9b).

Follow the instructions included with your EPROM programmer to program your chip. We advise that you try programming the standard character set

on your first attempt and use it to replace the VIDEX supplied EPROM in U-20. That way you can verify that you are following the correct procedures in "burning" your EPROMs.

B. Graphics

You can generate your own set of graphics display characters using your EPROM programmer. Follow exactly the same method you used in generating text character sets.

ASCII:



ASCII UC:



FRENCH:

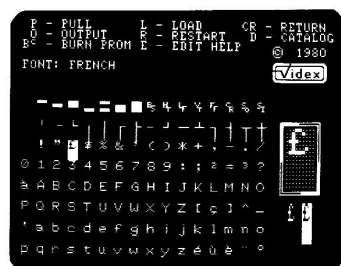

GERMAN:



KATAKANA:



SPANISH:

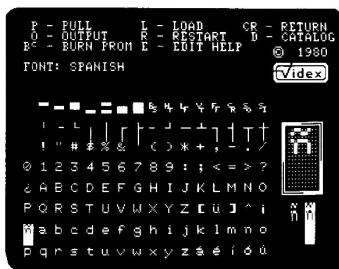

SYMBOL:

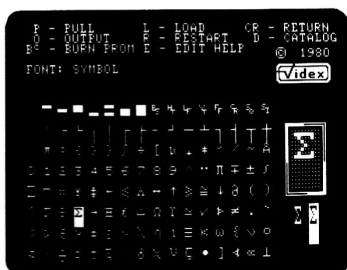

SUPER & SUBSCRIPT:



APL:



EPSON:



GRAPHICS CHARACTER SET

DATA 7 6 5 4 3 2 1 0		DATA 7 6 5 4 3 2 1 0		DATA 7 6 5 4 3 2 1 0		DATA 7 6 5 4 3 2 1 0	
00		10		20		30	
01		11		21		31	
02		12		22		32	
03		13		23		33	
04		14		24		34	
05		15		25		35	
06		16		26		36	
07		17		27		37	
08		18		28		38	
09		19		29		39	
0A		1A		2A		3A	
0B		1B		2B		3B	
0C		1C		2C		3C	
0D		1D		2D		3D	
0E		1E		2E		3E	
0F		1F		2F		3F	
DATA 7 6 5 4 3 2 1 0		DATA 7 6 5 4 3 2 1 0		DATA 7 6 5 4 3 2 1 0		DATA 7 6 5 4 3 2 1 0	
40		50		60		70	
41		51		61		71	
42		52		62		72	
43		53		63		73	
44		54		64		74	
45		55		65		75	
46		56		66		76	
47		57		67		77	
48		58		68		78	
49		59		69		79	
4A		5A		6A		7A	
4B		5B		6B		7B	
4C		5C		6C		7C	
4D		5D		6D		7D	
4E		5E		6E		7E	
4F		5F		6F		7F	
DATA 7 6 5 4 3 2 1 0		DATA 7 6 5 4 3 2 1 0		DATA 7 6 5 4 3 2 1 0		DATA 7 6 5 4 3 2 1 0	
80		90		A0		B0	
81		91		A1		B1	
82		92		A2		B2	
83		93		A3		B3	
84		94		A4		B4	
85		95		A5		B5	
86		96		A6		B6	
87		97		A7		B7	
88		98		A8		B8	
89		99		A9		B9	
8A		9A		AA		BA	
8B		9B		AB		BB	
8C		9C		AC		BC	
8D		9D		AD		BD	
8E		9E		AE		BE	
8F		9F		AF		BF	
DATA 7 6 5 4 3 2 1 0		DATA 7 6 5 4 3 2 1 0		DATA 7 6 5 4 3 2 1 0		DATA 7 6 5 4 3 2 1 0	
C0		D0		E0		F0	
C1		D1		E1		F1	
C2		D2		E2		F2	
C3		D3		E3		F3	
C4		D4		E4		F4	
C5		D5		E5		F5	
C6		D6		E6		F6	
C7		D7		E7		F7	
C8		D8		E8		F8	
C9		D9		E9		F9	
CA		DA		Ea		Fa	
CB		DB		Eb		Fb	
CC		DC		Ec		Fc	
CD		DD		Ed		Fd	
CE		DE		Ee		Fe	
CF		DF		Ef		Ff	

ADDRESS

GRAPHICS CHARACTER SET

<table border="1"> <thead> <tr><th colspan="4">DATA</th></tr> <tr><th>7</th><th>6</th><th>5</th><th>4</th></tr> </thead> <tbody> <tr><td>00</td><td></td><td></td><td></td></tr> <tr><td>01</td><td></td><td></td><td></td></tr> <tr><td>02</td><td></td><td></td><td></td></tr> <tr><td>03</td><td></td><td></td><td></td></tr> <tr><td>04</td><td></td><td></td><td></td></tr> <tr><td>05</td><td></td><td></td><td></td></tr> <tr><td>06</td><td></td><td></td><td></td></tr> <tr><td>07</td><td></td><td></td><td></td></tr> <tr><td>08</td><td></td><td></td><td></td></tr> <tr><td>09</td><td></td><td></td><td></td></tr> <tr><td>0A</td><td></td><td></td><td></td></tr> <tr><td>0B</td><td></td><td></td><td></td></tr> <tr><td>0C</td><td></td><td></td><td></td></tr> <tr><td>0D</td><td></td><td></td><td></td></tr> <tr><td>0E</td><td></td><td></td><td></td></tr> <tr><td>0F</td><td></td><td></td><td></td></tr> </tbody> </table>	DATA				7	6	5	4	00				01				02				03				04				05				06				07				08				09				0A				0B				0C				0D				0E				0F				<table border="1"> <thead> <tr><th colspan="4">DATA</th></tr> <tr><th>7</th><th>6</th><th>5</th><th>4</th></tr> </thead> <tbody> <tr><td>10</td><td></td><td></td><td></td></tr> <tr><td>11</td><td></td><td></td><td></td></tr> <tr><td>12</td><td></td><td></td><td></td></tr> <tr><td>13</td><td></td><td></td><td></td></tr> <tr><td>14</td><td></td><td></td><td></td></tr> <tr><td>15</td><td></td><td></td><td></td></tr> <tr><td>16</td><td></td><td></td><td></td></tr> <tr><td>17</td><td></td><td></td><td></td></tr> <tr><td>18</td><td></td><td></td><td></td></tr> <tr><td>19</td><td></td><td></td><td></td></tr> <tr><td>1A</td><td></td><td></td><td></td></tr> <tr><td>1B</td><td></td><td></td><td></td></tr> <tr><td>1C</td><td></td><td></td><td></td></tr> <tr><td>1D</td><td></td><td></td><td></td></tr> <tr><td>1E</td><td></td><td></td><td></td></tr> <tr><td>1F</td><td></td><td></td><td></td></tr> </tbody> </table>	DATA				7	6	5	4	10				11				12				13				14				15				16				17				18				19				1A				1B				1C				1D				1E				1F				<table border="1"> <thead> <tr><th colspan="4">DATA</th></tr> <tr><th>7</th><th>6</th><th>5</th><th>4</th></tr> </thead> <tbody> <tr><td>20</td><td></td><td></td><td></td></tr> <tr><td>21</td><td></td><td></td><td></td></tr> <tr><td>22</td><td></td><td></td><td></td></tr> <tr><td>23</td><td></td><td></td><td></td></tr> <tr><td>24</td><td></td><td></td><td></td></tr> <tr><td>25</td><td></td><td></td><td></td></tr> <tr><td>26</td><td></td><td></td><td></td></tr> <tr><td>27</td><td></td><td></td><td></td></tr> <tr><td>28</td><td></td><td></td><td></td></tr> <tr><td>29</td><td></td><td></td><td></td></tr> <tr><td>2A</td><td></td><td></td><td></td></tr> <tr><td>2B</td><td></td><td></td><td></td></tr> <tr><td>2C</td><td></td><td></td><td></td></tr> <tr><td>2D</td><td></td><td></td><td></td></tr> <tr><td>2E</td><td></td><td></td><td></td></tr> <tr><td>2F</td><td></td><td></td><td></td></tr> </tbody> </table>	DATA				7	6	5	4	20				21				22				23				24				25				26				27				28				29				2A				2B				2C				2D				2E				2F				<table border="1"> <thead> <tr><th colspan="4">DATA</th></tr> <tr><th>7</th><th>6</th><th>5</th><th>4</th></tr> </thead> <tbody> <tr><td>30</td><td></td><td></td><td></td></tr> <tr><td>31</td><td></td><td></td><td></td></tr> <tr><td>32</td><td></td><td></td><td></td></tr> <tr><td>33</td><td></td><td></td><td></td></tr> <tr><td>34</td><td></td><td></td><td></td></tr> <tr><td>35</td><td></td><td></td><td></td></tr> <tr><td>36</td><td></td><td></td><td></td></tr> <tr><td>37</td><td></td><td></td><td></td></tr> <tr><td>38</td><td></td><td></td><td></td></tr> <tr><td>39</td><td></td><td></td><td></td></tr> <tr><td>3A</td><td></td><td></td><td></td></tr> <tr><td>3B</td><td></td><td></td><td></td></tr> <tr><td>3C</td><td></td><td></td><td></td></tr> <tr><td>3D</td><td></td><td></td><td></td></tr> <tr><td>3E</td><td></td><td></td><td></td></tr> <tr><td>3F</td><td></td><td></td><td></td></tr> </tbody> </table>	DATA				7	6	5	4	30				31				32				33				34				35				36				37				38				39				3A				3B				3C				3D				3E				3F			
DATA																																																																																																																																																																																																																																																																																																			
7	6	5	4																																																																																																																																																																																																																																																																																																
00																																																																																																																																																																																																																																																																																																			
01																																																																																																																																																																																																																																																																																																			
02																																																																																																																																																																																																																																																																																																			
03																																																																																																																																																																																																																																																																																																			
04																																																																																																																																																																																																																																																																																																			
05																																																																																																																																																																																																																																																																																																			
06																																																																																																																																																																																																																																																																																																			
07																																																																																																																																																																																																																																																																																																			
08																																																																																																																																																																																																																																																																																																			
09																																																																																																																																																																																																																																																																																																			
0A																																																																																																																																																																																																																																																																																																			
0B																																																																																																																																																																																																																																																																																																			
0C																																																																																																																																																																																																																																																																																																			
0D																																																																																																																																																																																																																																																																																																			
0E																																																																																																																																																																																																																																																																																																			
0F																																																																																																																																																																																																																																																																																																			
DATA																																																																																																																																																																																																																																																																																																			
7	6	5	4																																																																																																																																																																																																																																																																																																
10																																																																																																																																																																																																																																																																																																			
11																																																																																																																																																																																																																																																																																																			
12																																																																																																																																																																																																																																																																																																			
13																																																																																																																																																																																																																																																																																																			
14																																																																																																																																																																																																																																																																																																			
15																																																																																																																																																																																																																																																																																																			
16																																																																																																																																																																																																																																																																																																			
17																																																																																																																																																																																																																																																																																																			
18																																																																																																																																																																																																																																																																																																			
19																																																																																																																																																																																																																																																																																																			
1A																																																																																																																																																																																																																																																																																																			
1B																																																																																																																																																																																																																																																																																																			
1C																																																																																																																																																																																																																																																																																																			
1D																																																																																																																																																																																																																																																																																																			
1E																																																																																																																																																																																																																																																																																																			
1F																																																																																																																																																																																																																																																																																																			
DATA																																																																																																																																																																																																																																																																																																			
7	6	5	4																																																																																																																																																																																																																																																																																																
20																																																																																																																																																																																																																																																																																																			
21																																																																																																																																																																																																																																																																																																			
22																																																																																																																																																																																																																																																																																																			
23																																																																																																																																																																																																																																																																																																			
24																																																																																																																																																																																																																																																																																																			
25																																																																																																																																																																																																																																																																																																			
26																																																																																																																																																																																																																																																																																																			
27																																																																																																																																																																																																																																																																																																			
28																																																																																																																																																																																																																																																																																																			
29																																																																																																																																																																																																																																																																																																			
2A																																																																																																																																																																																																																																																																																																			
2B																																																																																																																																																																																																																																																																																																			
2C																																																																																																																																																																																																																																																																																																			
2D																																																																																																																																																																																																																																																																																																			
2E																																																																																																																																																																																																																																																																																																			
2F																																																																																																																																																																																																																																																																																																			
DATA																																																																																																																																																																																																																																																																																																			
7	6	5	4																																																																																																																																																																																																																																																																																																
30																																																																																																																																																																																																																																																																																																			
31																																																																																																																																																																																																																																																																																																			
32																																																																																																																																																																																																																																																																																																			
33																																																																																																																																																																																																																																																																																																			
34																																																																																																																																																																																																																																																																																																			
35																																																																																																																																																																																																																																																																																																			
36																																																																																																																																																																																																																																																																																																			
37																																																																																																																																																																																																																																																																																																			
38																																																																																																																																																																																																																																																																																																			
39																																																																																																																																																																																																																																																																																																			
3A																																																																																																																																																																																																																																																																																																			
3B																																																																																																																																																																																																																																																																																																			
3C																																																																																																																																																																																																																																																																																																			
3D																																																																																																																																																																																																																																																																																																			
3E																																																																																																																																																																																																																																																																																																			
3F																																																																																																																																																																																																																																																																																																			
<table border="1"> <thead> <tr><th colspan="4">DATA</th></tr> <tr><th>7</th><th>6</th><th>5</th><th>4</th></tr> </thead> <tbody> <tr><td>40</td><td></td><td></td><td></td></tr> <tr><td>41</td><td></td><td></td><td></td></tr> <tr><td>42</td><td></td><td></td><td></td></tr> <tr><td>43</td><td></td><td></td><td></td></tr> <tr><td>44</td><td></td><td></td><td></td></tr> <tr><td>45</td><td></td><td></td><td></td></tr> <tr><td>46</td><td></td><td></td><td></td></tr> <tr><td>47</td><td></td><td></td><td></td></tr> <tr><td>48</td><td></td><td></td><td></td></tr> <tr><td>49</td><td></td><td></td><td></td></tr> <tr><td>4A</td><td></td><td></td><td></td></tr> <tr><td>4B</td><td></td><td></td><td></td></tr> <tr><td>4C</td><td></td><td></td><td></td></tr> <tr><td>4D</td><td></td><td></td><td></td></tr> <tr><td>4E</td><td></td><td></td><td></td></tr> <tr><td>4F</td><td></td><td></td><td></td></tr> </tbody> </table>	DATA				7	6	5	4	40				41				42				43				44				45				46				47				48				49				4A				4B				4C				4D				4E				4F				<table border="1"> <thead> <tr><th colspan="4">DATA</th></tr> <tr><th>7</th><th>6</th><th>5</th><th>4</th></tr> </thead> <tbody> <tr><td>50</td><td></td><td></td><td></td></tr> <tr><td>51</td><td></td><td></td><td></td></tr> <tr><td>52</td><td></td><td></td><td></td></tr> <tr><td>53</td><td></td><td></td><td></td></tr> <tr><td>54</td><td></td><td></td><td></td></tr> <tr><td>55</td><td></td><td></td><td></td></tr> <tr><td>56</td><td></td><td></td><td></td></tr> <tr><td>57</td><td></td><td></td><td></td></tr> <tr><td>58</td><td></td><td></td><td></td></tr> <tr><td>59</td><td></td><td></td><td></td></tr> <tr><td>5A</td><td></td><td></td><td></td></tr> <tr><td>5B</td><td></td><td></td><td></td></tr> <tr><td>5C</td><td></td><td></td><td></td></tr> <tr><td>5D</td><td></td><td></td><td></td></tr> <tr><td>5E</td><td></td><td></td><td></td></tr> <tr><td>5F</td><td></td><td></td><td></td></tr> </tbody> </table>	DATA				7	6	5	4	50				51				52				53				54				55				56				57				58				59				5A				5B				5C				5D				5E				5F				<table border="1"> <thead> <tr><th colspan="4">DATA</th></tr> <tr><th>7</th><th>6</th><th>5</th><th>4</th></tr> </thead> <tbody> <tr><td>60</td><td></td><td></td><td></td></tr> <tr><td>61</td><td></td><td></td><td></td></tr> <tr><td>62</td><td></td><td></td><td></td></tr> <tr><td>63</td><td></td><td></td><td></td></tr> <tr><td>64</td><td></td><td></td><td></td></tr> <tr><td>65</td><td></td><td></td><td></td></tr> <tr><td>66</td><td></td><td></td><td></td></tr> <tr><td>67</td><td></td><td></td><td></td></tr> <tr><td>68</td><td></td><td></td><td></td></tr> <tr><td>69</td><td></td><td></td><td></td></tr> <tr><td>6A</td><td></td><td></td><td></td></tr> <tr><td>6B</td><td></td><td></td><td></td></tr> <tr><td>6C</td><td></td><td></td><td></td></tr> <tr><td>6D</td><td></td><td></td><td></td></tr> <tr><td>6E</td><td></td><td></td><td></td></tr> <tr><td>6F</td><td></td><td></td><td></td></tr> </tbody> </table>	DATA				7	6	5	4	60				61				62				63				64				65				66				67				68				69				6A				6B				6C				6D				6E				6F				<table border="1"> <thead> <tr><th colspan="4">DATA</th></tr> <tr><th>7</th><th>6</th><th>5</th><th>4</th></tr> </thead> <tbody> <tr><td>70</td><td></td><td></td><td></td></tr> <tr><td>71</td><td></td><td></td><td></td></tr> <tr><td>72</td><td></td><td></td><td></td></tr> <tr><td>73</td><td></td><td></td><td></td></tr> <tr><td>74</td><td></td><td></td><td></td></tr> <tr><td>75</td><td></td><td></td><td></td></tr> <tr><td>76</td><td></td><td></td><td></td></tr> <tr><td>77</td><td></td><td></td><td></td></tr> <tr><td>78</td><td></td><td></td><td></td></tr> <tr><td>79</td><td></td><td></td><td></td></tr> <tr><td>7A</td><td></td><td></td><td></td></tr> <tr><td>7B</td><td></td><td></td><td></td></tr> <tr><td>7C</td><td></td><td></td><td></td></tr> <tr><td>7D</td><td></td><td></td><td></td></tr> <tr><td>7E</td><td></td><td></td><td></td></tr> <tr><td>7F</td><td></td><td></td><td></td></tr> </tbody> </table>	DATA				7	6	5	4	70				71				72				73				74				75				76				77				78				79				7A				7B				7C				7D				7E				7F			
DATA																																																																																																																																																																																																																																																																																																			
7	6	5	4																																																																																																																																																																																																																																																																																																
40																																																																																																																																																																																																																																																																																																			
41																																																																																																																																																																																																																																																																																																			
42																																																																																																																																																																																																																																																																																																			
43																																																																																																																																																																																																																																																																																																			
44																																																																																																																																																																																																																																																																																																			
45																																																																																																																																																																																																																																																																																																			
46																																																																																																																																																																																																																																																																																																			
47																																																																																																																																																																																																																																																																																																			
48																																																																																																																																																																																																																																																																																																			
49																																																																																																																																																																																																																																																																																																			
4A																																																																																																																																																																																																																																																																																																			
4B																																																																																																																																																																																																																																																																																																			
4C																																																																																																																																																																																																																																																																																																			
4D																																																																																																																																																																																																																																																																																																			
4E																																																																																																																																																																																																																																																																																																			
4F																																																																																																																																																																																																																																																																																																			
DATA																																																																																																																																																																																																																																																																																																			
7	6	5	4																																																																																																																																																																																																																																																																																																
50																																																																																																																																																																																																																																																																																																			
51																																																																																																																																																																																																																																																																																																			
52																																																																																																																																																																																																																																																																																																			
53																																																																																																																																																																																																																																																																																																			
54																																																																																																																																																																																																																																																																																																			
55																																																																																																																																																																																																																																																																																																			
56																																																																																																																																																																																																																																																																																																			
57																																																																																																																																																																																																																																																																																																			
58																																																																																																																																																																																																																																																																																																			
59																																																																																																																																																																																																																																																																																																			
5A																																																																																																																																																																																																																																																																																																			
5B																																																																																																																																																																																																																																																																																																			
5C																																																																																																																																																																																																																																																																																																			
5D																																																																																																																																																																																																																																																																																																			
5E																																																																																																																																																																																																																																																																																																			
5F																																																																																																																																																																																																																																																																																																			
DATA																																																																																																																																																																																																																																																																																																			
7	6	5	4																																																																																																																																																																																																																																																																																																
60																																																																																																																																																																																																																																																																																																			
61																																																																																																																																																																																																																																																																																																			
62																																																																																																																																																																																																																																																																																																			
63																																																																																																																																																																																																																																																																																																			
64																																																																																																																																																																																																																																																																																																			
65																																																																																																																																																																																																																																																																																																			
66																																																																																																																																																																																																																																																																																																			
67																																																																																																																																																																																																																																																																																																			
68																																																																																																																																																																																																																																																																																																			
69																																																																																																																																																																																																																																																																																																			
6A																																																																																																																																																																																																																																																																																																			
6B																																																																																																																																																																																																																																																																																																			
6C																																																																																																																																																																																																																																																																																																			
6D																																																																																																																																																																																																																																																																																																			
6E																																																																																																																																																																																																																																																																																																			
6F																																																																																																																																																																																																																																																																																																			
DATA																																																																																																																																																																																																																																																																																																			
7	6	5	4																																																																																																																																																																																																																																																																																																
70																																																																																																																																																																																																																																																																																																			
71																																																																																																																																																																																																																																																																																																			
72																																																																																																																																																																																																																																																																																																			
73																																																																																																																																																																																																																																																																																																			
74																																																																																																																																																																																																																																																																																																			
75																																																																																																																																																																																																																																																																																																			
76																																																																																																																																																																																																																																																																																																			
77																																																																																																																																																																																																																																																																																																			
78																																																																																																																																																																																																																																																																																																			
79																																																																																																																																																																																																																																																																																																			
7A																																																																																																																																																																																																																																																																																																			
7B																																																																																																																																																																																																																																																																																																			
7C																																																																																																																																																																																																																																																																																																			
7D																																																																																																																																																																																																																																																																																																			
7E																																																																																																																																																																																																																																																																																																			
7F																																																																																																																																																																																																																																																																																																			
<table border="1"> <thead> <tr><th colspan="4">DATA</th></tr> <tr><th>7</th><th>6</th><th>5</th><th>4</th></tr> </thead> <tbody> <tr><td>80</td><td></td><td></td><td></td></tr> <tr><td>81</td><td></td><td></td><td></td></tr> <tr><td>82</td><td></td><td></td><td></td></tr> <tr><td>83</td><td></td><td></td><td></td></tr> <tr><td>84</td><td></td><td></td><td></td></tr> <tr><td>85</td><td></td><td></td><td></td></tr> <tr><td>86</td><td></td><td></td><td></td></tr> <tr><td>87</td><td></td><td></td><td></td></tr> <tr><td>88</td><td></td><td></td><td></td></tr> <tr><td>89</td><td></td><td></td><td></td></tr> <tr><td>8A</td><td></td><td></td><td></td></tr> <tr><td>8B</td><td></td><td></td><td></td></tr> <tr><td>8C</td><td></td><td></td><td></td></tr> <tr><td>8D</td><td></td><td></td><td></td></tr> <tr><td>8E</td><td></td><td></td><td></td></tr> <tr><td>8F</td><td></td><td></td><td></td></tr> </tbody> </table>	DATA				7	6	5	4	80				81				82				83				84				85				86				87				88				89				8A				8B				8C				8D				8E				8F				<table border="1"> <thead> <tr><th colspan="4">DATA</th></tr> <tr><th>7</th><th>6</th><th>5</th><th>4</th></tr> </thead> <tbody> <tr><td>90</td><td></td><td></td><td></td></tr> <tr><td>91</td><td></td><td></td><td></td></tr> <tr><td>92</td><td></td><td></td><td></td></tr> <tr><td>93</td><td></td><td></td><td></td></tr> <tr><td>94</td><td></td><td></td><td></td></tr> <tr><td>95</td><td></td><td></td><td></td></tr> <tr><td>96</td><td></td><td></td><td></td></tr> <tr><td>97</td><td></td><td></td><td></td></tr> <tr><td>98</td><td></td><td></td><td></td></tr> <tr><td>99</td><td></td><td></td><td></td></tr> <tr><td>9A</td><td></td><td></td><td></td></tr> <tr><td>9B</td><td></td><td></td><td></td></tr> <tr><td>9C</td><td></td><td></td><td></td></tr> <tr><td>9D</td><td></td><td></td><td></td></tr> <tr><td>9E</td><td></td><td></td><td></td></tr> <tr><td>9F</td><td></td><td></td><td></td></tr> </tbody> </table>	DATA				7	6	5	4	90				91				92				93				94				95				96				97				98				99				9A				9B				9C				9D				9E				9F				<table border="1"> <thead> <tr><th colspan="4">DATA</th></tr> <tr><th>7</th><th>6</th><th>5</th><th>4</th></tr> </thead> <tbody> <tr><td>A0</td><td></td><td></td><td></td></tr> <tr><td>A1</td><td></td><td></td><td></td></tr> <tr><td>A2</td><td></td><td></td><td></td></tr> <tr><td>A3</td><td></td><td></td><td></td></tr> <tr><td>A4</td><td></td><td></td><td></td></tr> <tr><td>A5</td><td></td><td></td><td></td></tr> <tr><td>A6</td><td></td><td></td><td></td></tr> <tr><td>A7</td><td></td><td></td><td></td></tr> <tr><td>A8</td><td></td><td></td><td></td></tr> <tr><td>A9</td><td></td><td></td><td></td></tr> <tr><td>AA</td><td></td><td></td><td></td></tr> <tr><td>AB</td><td></td><td></td><td></td></tr> <tr><td>AC</td><td></td><td></td><td></td></tr> <tr><td>AD</td><td></td><td></td><td></td></tr> <tr><td>AE</td><td></td><td></td><td></td></tr> <tr><td>AF</td><td></td><td></td><td></td></tr> </tbody> </table>	DATA				7	6	5	4	A0				A1				A2				A3				A4				A5				A6				A7				A8				A9				AA				AB				AC				AD				AE				AF				<table border="1"> <thead> <tr><th colspan="4">DATA</th></tr> <tr><th>7</th><th>6</th><th>5</th><th>4</th></tr> </thead> <tbody> <tr><td>B0</td><td></td><td></td><td></td></tr> <tr><td>B1</td><td></td><td></td><td></td></tr> <tr><td>B2</td><td></td><td></td><td></td></tr> <tr><td>B3</td><td></td><td></td><td></td></tr> <tr><td>B4</td><td></td><td></td><td></td></tr> <tr><td>B5</td><td></td><td></td><td></td></tr> <tr><td>B6</td><td></td><td></td><td></td></tr> <tr><td>B7</td><td></td><td></td><td></td></tr> <tr><td>B8</td><td></td><td></td><td></td></tr> <tr><td>B9</td><td></td><td></td><td></td></tr> <tr><td>BA</td><td></td><td></td><td></td></tr> <tr><td>BB</td><td></td><td></td><td></td></tr> <tr><td>BC</td><td></td><td></td><td></td></tr> <tr><td>BD</td><td></td><td></td><td></td></tr> <tr><td>BE</td><td></td><td></td><td></td></tr> <tr><td>BF</td><td></td><td></td><td></td></tr> </tbody> </table>	DATA				7	6	5	4	B0				B1				B2				B3				B4				B5				B6				B7				B8				B9				BA				BB				BC				BD				BE				BF			
DATA																																																																																																																																																																																																																																																																																																			
7	6	5	4																																																																																																																																																																																																																																																																																																
80																																																																																																																																																																																																																																																																																																			
81																																																																																																																																																																																																																																																																																																			
82																																																																																																																																																																																																																																																																																																			
83																																																																																																																																																																																																																																																																																																			
84																																																																																																																																																																																																																																																																																																			
85																																																																																																																																																																																																																																																																																																			
86																																																																																																																																																																																																																																																																																																			
87																																																																																																																																																																																																																																																																																																			
88																																																																																																																																																																																																																																																																																																			
89																																																																																																																																																																																																																																																																																																			
8A																																																																																																																																																																																																																																																																																																			
8B																																																																																																																																																																																																																																																																																																			
8C																																																																																																																																																																																																																																																																																																			
8D																																																																																																																																																																																																																																																																																																			
8E																																																																																																																																																																																																																																																																																																			
8F																																																																																																																																																																																																																																																																																																			
DATA																																																																																																																																																																																																																																																																																																			
7	6	5	4																																																																																																																																																																																																																																																																																																
90																																																																																																																																																																																																																																																																																																			
91																																																																																																																																																																																																																																																																																																			
92																																																																																																																																																																																																																																																																																																			
93																																																																																																																																																																																																																																																																																																			
94																																																																																																																																																																																																																																																																																																			
95																																																																																																																																																																																																																																																																																																			
96																																																																																																																																																																																																																																																																																																			
97																																																																																																																																																																																																																																																																																																			
98																																																																																																																																																																																																																																																																																																			
99																																																																																																																																																																																																																																																																																																			
9A																																																																																																																																																																																																																																																																																																			
9B																																																																																																																																																																																																																																																																																																			
9C																																																																																																																																																																																																																																																																																																			
9D																																																																																																																																																																																																																																																																																																			
9E																																																																																																																																																																																																																																																																																																			
9F																																																																																																																																																																																																																																																																																																			
DATA																																																																																																																																																																																																																																																																																																			
7	6	5	4																																																																																																																																																																																																																																																																																																
A0																																																																																																																																																																																																																																																																																																			
A1																																																																																																																																																																																																																																																																																																			
A2																																																																																																																																																																																																																																																																																																			
A3																																																																																																																																																																																																																																																																																																			
A4																																																																																																																																																																																																																																																																																																			
A5																																																																																																																																																																																																																																																																																																			
A6																																																																																																																																																																																																																																																																																																			
A7																																																																																																																																																																																																																																																																																																			
A8																																																																																																																																																																																																																																																																																																			
A9																																																																																																																																																																																																																																																																																																			
AA																																																																																																																																																																																																																																																																																																			
AB																																																																																																																																																																																																																																																																																																			
AC																																																																																																																																																																																																																																																																																																			
AD																																																																																																																																																																																																																																																																																																			
AE																																																																																																																																																																																																																																																																																																			
AF																																																																																																																																																																																																																																																																																																			
DATA																																																																																																																																																																																																																																																																																																			
7	6	5	4																																																																																																																																																																																																																																																																																																
B0																																																																																																																																																																																																																																																																																																			
B1																																																																																																																																																																																																																																																																																																			
B2																																																																																																																																																																																																																																																																																																			
B3																																																																																																																																																																																																																																																																																																			
B4																																																																																																																																																																																																																																																																																																			
B5																																																																																																																																																																																																																																																																																																			
B6																																																																																																																																																																																																																																																																																																			
B7																																																																																																																																																																																																																																																																																																			
B8																																																																																																																																																																																																																																																																																																			
B9																																																																																																																																																																																																																																																																																																			
BA																																																																																																																																																																																																																																																																																																			
BB																																																																																																																																																																																																																																																																																																			
BC																																																																																																																																																																																																																																																																																																			
BD																																																																																																																																																																																																																																																																																																			
BE																																																																																																																																																																																																																																																																																																			
BF																																																																																																																																																																																																																																																																																																			
<table border="1"> <thead> <tr><th colspan="4">DATA</th></tr> <tr><th>7</th><th>6</th><th>5</th><th>4</th></tr> </thead> <tbody> <tr><td>C0</td><td></td><td></td><td></td></tr> <tr><td>C1</td><td></td><td></td><td></td></tr> <tr><td>C2</td><td></td><td></td><td></td></tr> <tr><td>C3</td><td></td><td></td><td></td></tr> <tr><td>C4</td><td></td><td></td><td></td></tr> <tr><td>C5</td><td></td><td></td><td></td></tr> <tr><td>C6</td><td></td><td></td><td></td></tr> <tr><td>C7</td><td></td><td></td><td></td></tr> <tr><td>C8</td><td></td><td></td><td></td></tr> <tr><td>C9</td><td></td><td></td><td></td></tr> <tr><td>CA</td><td></td><td></td><td></td></tr> <tr><td>CB</td><td></td><td></td><td></td></tr> <tr><td>CC</td><td></td><td></td><td></td></tr> <tr><td>CD</td><td></td><td></td><td></td></tr> <tr><td>CE</td><td></td><td></td><td></td></tr> <tr><td>CF</td><td></td><td></td><td></td></tr> </tbody> </table>	DATA				7	6	5	4	C0				C1				C2				C3				C4				C5				C6				C7				C8				C9				CA				CB				CC				CD				CE				CF				<table border="1"> <thead> <tr><th colspan="4">DATA</th></tr> <tr><th>7</th><th>6</th><th>5</th><th>4</th></tr> </thead> <tbody> <tr><td>D0</td><td></td><td></td><td></td></tr> <tr><td>D1</td><td></td><td></td><td></td></tr> <tr><td>D2</td><td></td><td></td><td></td></tr> <tr><td>D3</td><td></td><td></td><td></td></tr> <tr><td>D4</td><td></td><td></td><td></td></tr> <tr><td>D5</td><td></td><td></td><td></td></tr> <tr><td>D6</td><td></td><td></td><td></td></tr> <tr><td>D7</td><td></td><td></td><td></td></tr> <tr><td>D8</td><td></td><td></td><td></td></tr> <tr><td>DA</td><td></td><td></td><td></td></tr> <tr><td>DB</td><td></td><td></td><td></td></tr> <tr><td>DC</td><td></td><td></td><td></td></tr> <tr><td>DD</td><td></td><td></td><td></td></tr> <tr><td>DE</td><td></td><td></td><td></td></tr> <tr><td>DF</td><td></td><td></td><td></td></tr> </tbody> </table>	DATA				7	6	5	4	D0				D1				D2				D3				D4				D5				D6				D7				D8				DA				DB				DC				DD				DE				DF				<table border="1"> <thead> <tr><th colspan="4">DATA</th></tr> <tr><th>7</th><th>6</th><th>5</th><th>4</th></tr> </thead> <tbody> <tr><td>E0</td><td></td><td></td><td></td></tr> <tr><td>E1</td><td></td><td></td><td></td></tr> <tr><td>E2</td><td></td><td></td><td></td></tr> <tr><td>E3</td><td></td><td></td><td></td></tr> <tr><td>E4</td><td></td><td></td><td></td></tr> <tr><td>E5</td><td></td><td></td><td></td></tr> <tr><td>E6</td><td></td><td></td><td></td></tr> <tr><td>E7</td><td></td><td></td><td></td></tr> <tr><td>E8</td><td></td><td></td><td></td></tr> <tr><td>E9</td><td></td><td></td><td></td></tr> <tr><td>EA</td><td></td><td></td><td></td></tr> <tr><td>EB</td><td></td><td></td><td></td></tr> <tr><td>EC</td><td></td><td></td><td></td></tr> <tr><td>ED</td><td></td><td></td><td></td></tr> <tr><td>EE</td><td></td><td></td><td></td></tr> <tr><td>EF</td><td></td><td></td><td></td></tr> </tbody> </table>	DATA				7	6	5	4	E0				E1				E2				E3				E4				E5				E6				E7				E8				E9				EA				EB				EC				ED				EE				EF				<table border="1"> <thead> <tr><th colspan="4">DATA</th></tr> <tr><th>7</th><th>6</th><th>5</th><th>4</th></tr> </thead> <tbody> <tr><td>F0</td><td></td><td></td><td></td></tr> <tr><td>F1</td><td></td><td></td><td></td></tr> <tr><td>F2</td><td></td><td></td><td></td></tr> <tr><td>F3</td><td></td><td></td><td></td></tr> <tr><td>F4</td><td></td><td></td><td></td></tr> <tr><td>F5</td><td></td><td></td><td></td></tr> <tr><td>F6</td><td></td><td></td><td></td></tr> <tr><td>F7</td><td></td><td></td><td></td></tr> <tr><td>F8</td><td></td><td></td><td></td></tr> <tr><td>FA</td><td></td><td></td><td></td></tr> <tr><td>FB</td><td></td><td></td><td></td></tr> <tr><td>FC</td><td></td><td></td><td></td></tr> <tr><td>FD</td><td></td><td></td><td></td></tr> <tr><td>FE</td><td></td><td></td><td></td></tr> <tr><td>FF</td><td></td><td></td><td></td></tr> </tbody> </table>	DATA				7	6	5	4	F0				F1				F2				F3				F4				F5				F6				F7				F8				FA				FB				FC				FD				FE				FF											
DATA																																																																																																																																																																																																																																																																																																			
7	6	5	4																																																																																																																																																																																																																																																																																																
C0																																																																																																																																																																																																																																																																																																			
C1																																																																																																																																																																																																																																																																																																			
C2																																																																																																																																																																																																																																																																																																			
C3																																																																																																																																																																																																																																																																																																			
C4																																																																																																																																																																																																																																																																																																			
C5																																																																																																																																																																																																																																																																																																			
C6																																																																																																																																																																																																																																																																																																			
C7																																																																																																																																																																																																																																																																																																			
C8																																																																																																																																																																																																																																																																																																			
C9																																																																																																																																																																																																																																																																																																			
CA																																																																																																																																																																																																																																																																																																			
CB																																																																																																																																																																																																																																																																																																			
CC																																																																																																																																																																																																																																																																																																			
CD																																																																																																																																																																																																																																																																																																			
CE																																																																																																																																																																																																																																																																																																			
CF																																																																																																																																																																																																																																																																																																			
DATA																																																																																																																																																																																																																																																																																																			
7	6	5	4																																																																																																																																																																																																																																																																																																
D0																																																																																																																																																																																																																																																																																																			
D1																																																																																																																																																																																																																																																																																																			
D2																																																																																																																																																																																																																																																																																																			
D3																																																																																																																																																																																																																																																																																																			
D4																																																																																																																																																																																																																																																																																																			
D5																																																																																																																																																																																																																																																																																																			
D6																																																																																																																																																																																																																																																																																																			
D7																																																																																																																																																																																																																																																																																																			
D8																																																																																																																																																																																																																																																																																																			
DA																																																																																																																																																																																																																																																																																																			
DB																																																																																																																																																																																																																																																																																																			
DC																																																																																																																																																																																																																																																																																																			
DD																																																																																																																																																																																																																																																																																																			
DE																																																																																																																																																																																																																																																																																																			
DF																																																																																																																																																																																																																																																																																																			
DATA																																																																																																																																																																																																																																																																																																			
7	6	5	4																																																																																																																																																																																																																																																																																																
E0																																																																																																																																																																																																																																																																																																			
E1																																																																																																																																																																																																																																																																																																			
E2																																																																																																																																																																																																																																																																																																			
E3																																																																																																																																																																																																																																																																																																			
E4																																																																																																																																																																																																																																																																																																			
E5																																																																																																																																																																																																																																																																																																			
E6																																																																																																																																																																																																																																																																																																			
E7																																																																																																																																																																																																																																																																																																			
E8																																																																																																																																																																																																																																																																																																			
E9																																																																																																																																																																																																																																																																																																			
EA																																																																																																																																																																																																																																																																																																			
EB																																																																																																																																																																																																																																																																																																			
EC																																																																																																																																																																																																																																																																																																			
ED																																																																																																																																																																																																																																																																																																			
EE																																																																																																																																																																																																																																																																																																			
EF																																																																																																																																																																																																																																																																																																			
DATA																																																																																																																																																																																																																																																																																																			
7	6	5	4																																																																																																																																																																																																																																																																																																
F0																																																																																																																																																																																																																																																																																																			
F1																																																																																																																																																																																																																																																																																																			
F2																																																																																																																																																																																																																																																																																																			
F3																																																																																																																																																																																																																																																																																																			
F4																																																																																																																																																																																																																																																																																																			
F5																																																																																																																																																																																																																																																																																																			
F6																																																																																																																																																																																																																																																																																																			
F7																																																																																																																																																																																																																																																																																																			
F8																																																																																																																																																																																																																																																																																																			
FA																																																																																																																																																																																																																																																																																																			
FB																																																																																																																																																																																																																																																																																																			
FC																																																																																																																																																																																																																																																																																																			
FD																																																																																																																																																																																																																																																																																																			
FE																																																																																																																																																																																																																																																																																																			
FF																																																																																																																																																																																																																																																																																																			

ADDRESS ↑

GRAPHICS CHARACTER SET

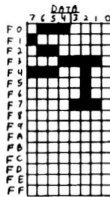
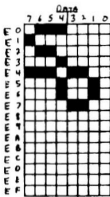
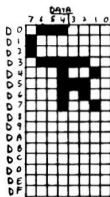
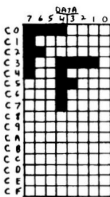
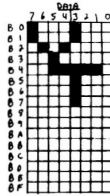
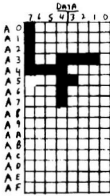
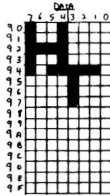
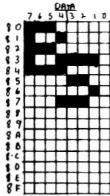
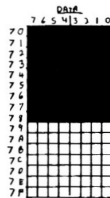
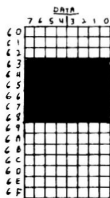
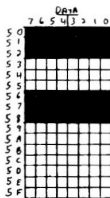
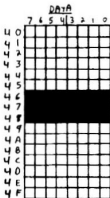
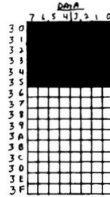
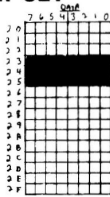
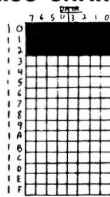
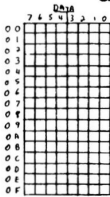

ADDRESS ↗

GRAPHICS CHARACTER SET

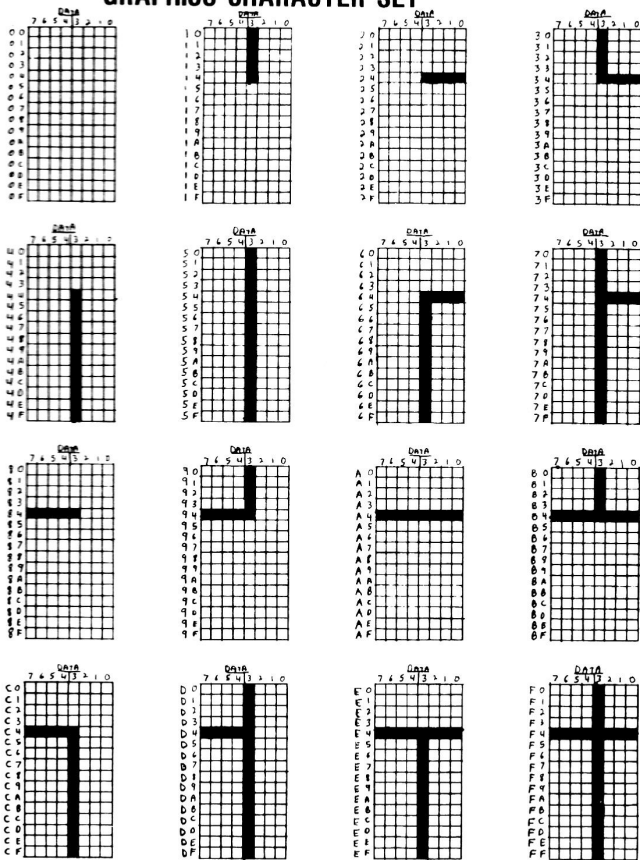

ADDRESS ↗

GRAPHICS CHARACTER SET

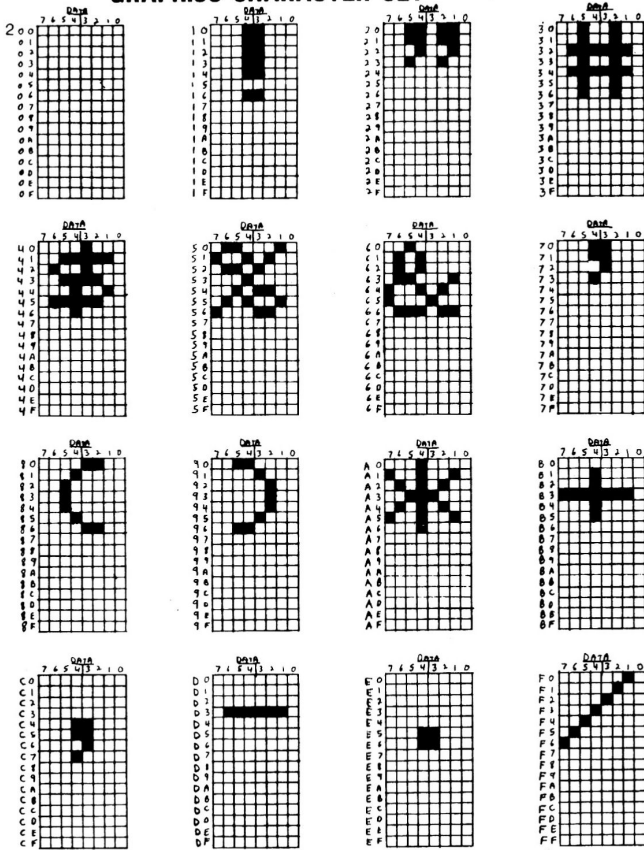

ADDRESS ↗

GRAPHICS CHARACTER SET

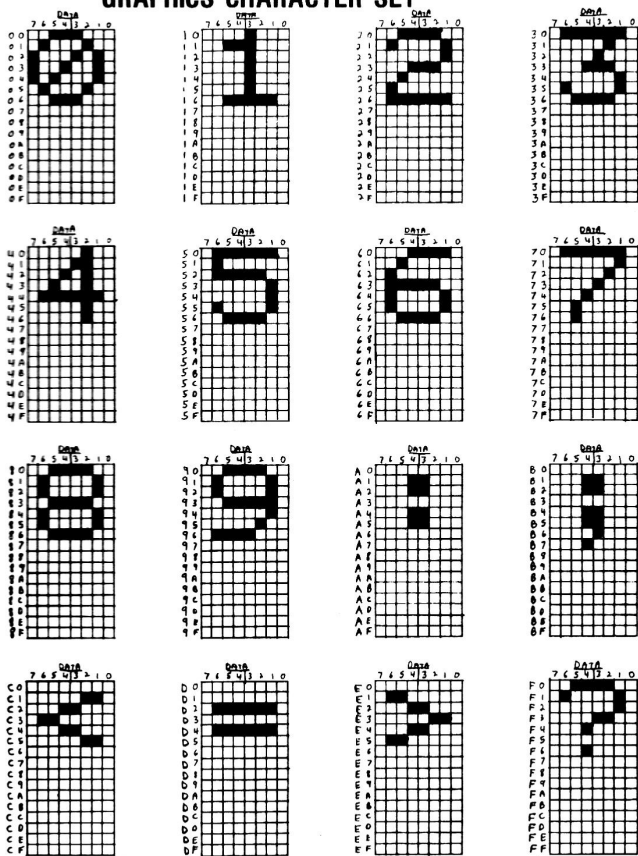

ADDRESS ↑

GRAPHICS CHARACTER SET

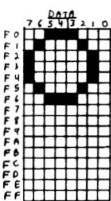
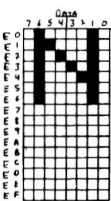
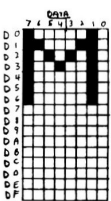
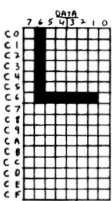
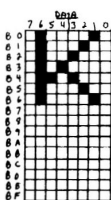
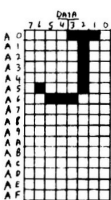
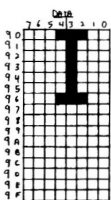
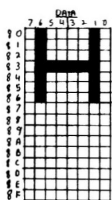
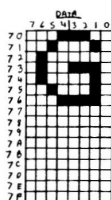
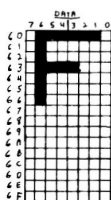
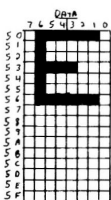
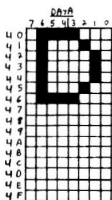
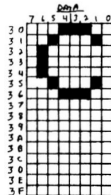
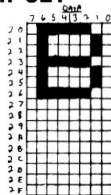
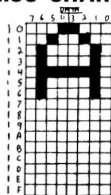
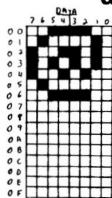

ADDRESS ↑

GRAPHICS CHARACTER SET

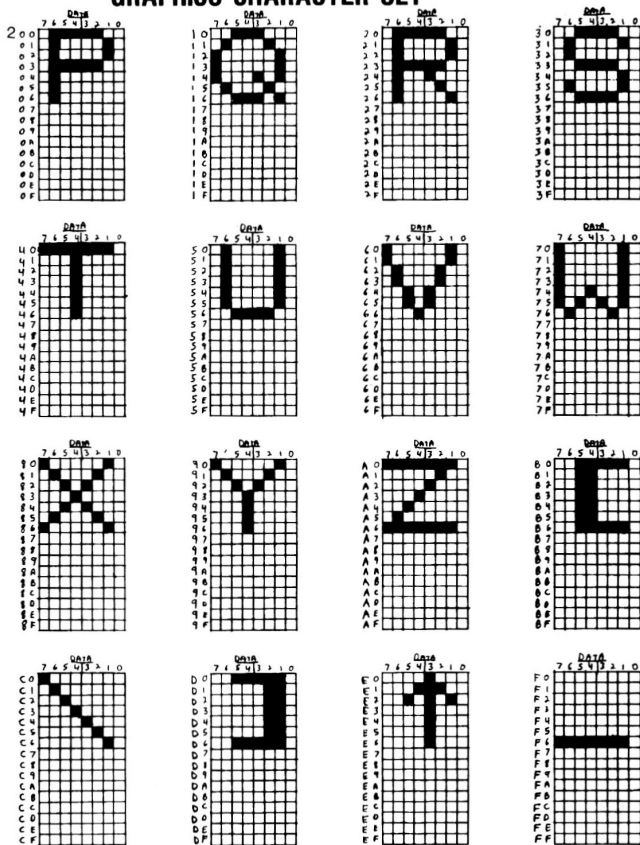

ADDRESS ↗

GRAPHICS CHARACTER SET

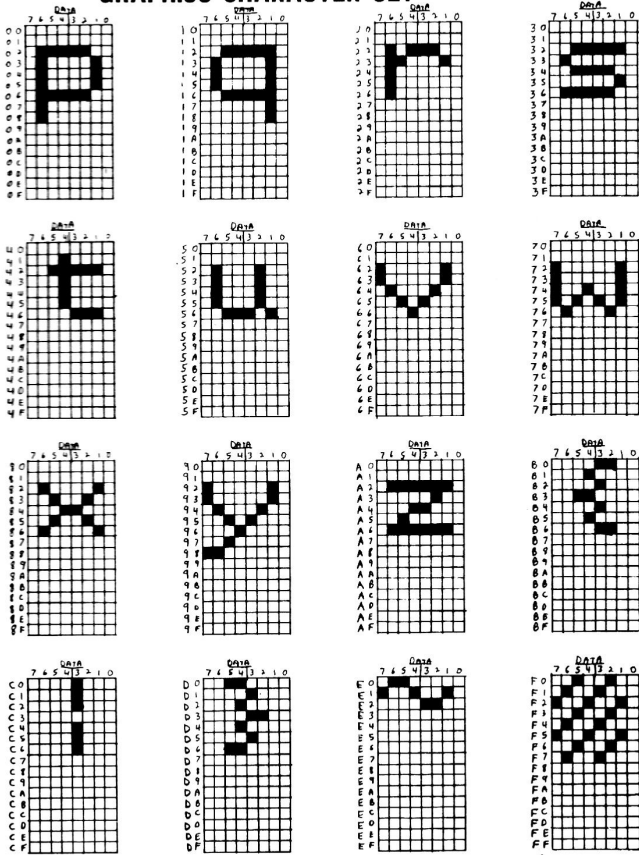

ADDRESS ↑

GRAPHICS CHARACTER SET

Data 7 4 5 4 3 2 1 0 0 0 0 1 0 2 0 3 0 4 0 5 0 6 0 7 0 8 0 9 0 A 0 B 0 C 0 D 0 E 0 F	Data 7 4 5 4 3 2 1 0 1 0 1 1 1 2 1 3 1 4 1 5 1 6 1 7 1 8 1 9 1 A 1 B 1 C 1 D 1 E 1 F	Data 7 4 5 4 3 2 1 0 2 0 2 1 2 2 2 3 2 4 2 5 2 6 2 7 2 8 2 9 2 A 2 B 2 C 2 D 2 E 2 F	Data 7 4 5 4 3 2 1 0 3 0 3 1 3 2 3 3 3 4 3 5 3 6 3 7 3 8 3 9 3 A 3 B 3 C 3 D 3 E 3 F
Data 7 4 5 4 3 2 1 0 4 0 4 1 4 2 4 3 4 4 4 5 4 6 4 7 4 8 4 9 4 A 4 B 4 C 4 D 4 E 4 F	Data 7 4 5 4 3 2 1 0 5 0 5 1 5 2 5 3 5 4 5 5 5 6 5 7 5 8 5 9 5 A 5 B 5 C 5 D 5 E 5 F	Data 7 4 5 4 3 2 1 0 6 0 6 1 6 2 6 3 6 4 6 5 6 6 6 7 6 8 6 9 6 A 6 B 6 C 6 D 6 E 6 F	Data 7 4 5 4 3 2 1 0 7 0 7 1 7 2 7 3 7 4 7 5 7 6 7 7 7 8 7 9 7 A 7 B 7 C 7 D 7 E 7 F
Data 7 4 5 4 3 2 1 0 8 0 8 1 8 2 8 3 8 4 8 5 8 6 8 7 8 8 8 9 8 A 8 B 8 C 8 D 8 E 8 F	Data 7 4 5 4 3 2 1 0 9 0 9 1 9 2 9 3 9 4 9 5 9 6 9 7 9 8 9 9 9 A 9 B 9 C 9 D 9 E 9 F	Data 7 4 5 4 3 2 1 0 A 0 A 1 A 2 A 3 A 4 A 5 A 6 A 7 A 8 A 9 A A A B A C A D A E A F	Data 7 4 5 4 3 2 1 0 B 0 B 1 B 2 B 3 B 4 B 5 B 6 B 7 B 8 B 9 B A B B B C B D B E B F
Data 7 4 5 4 3 2 1 0 C 0 C 1 C 2 C 3 C 4 C 5 C 6 C 7 C 8 C 9 C A C B C C C D C E C F	Data 7 4 5 4 3 2 1 0 D 0 D 1 D 2 D 3 D 4 D 5 D 6 D 7 D 8 D 9 D A D B D C D D D E D F	Data 7 4 5 4 3 2 1 0 E 0 E 1 E 2 E 3 E 4 E 5 E 6 E 7 E 8 E 9 E A E B E C E D E E E F	Data 7 4 5 4 3 2 1 0 F 0 F 1 F 2 F 3 F 4 F 5 F 6 F 7 F 8 F 9 F A F B F C F D F E F F

ADDRESS

GRAPHICS CHARACTER SET

DATA 7 6 5 4 3 2 1 0	DATA 7 6 5 4 3 2 1 0	DATA 7 6 5 4 3 2 1 0	DATA 7 6 5 4 3 2 1 0
00	10	20	30
01	11	21	31
02	12	22	32
03	13	23	33
04	14	24	34
05	15	25	35
06	16	26	36
07	17	27	37
08	18	28	38
09	19	29	39
0A	1A	2A	3A
0B	1B	2B	3B
0C	1C	2C	3C
0D	1D	2D	3D
0E	1E	2E	3E
0F	1F	2F	3F
40	50	60	70
41	51	61	71
42	52	62	72
43	53	63	73
44	54	64	74
45	55	65	75
46	56	66	76
47	57	67	77
48	58	68	78
49	59	69	79
4A	5A	6A	7A
4B	5B	6B	7B
4C	5C	6C	7C
4D	5D	6D	7D
4E	5E	6E	7E
4F	5F	6F	7F
80	90	A0	B0
81	91	A1	B1
82	92	A2	B2
83	93	A3	B3
84	94	A4	B4
85	95	A5	B5
86	96	A6	B6
87	97	A7	B7
88	98	A8	B8
89	99	A9	B9
8A	9A	AA	BA
8B	9B	AB	BB
8C	9C	AC	BC
8D	9D	AD	BD
8E	9E	AE	BE
8F	9F	AF	BF
C0	D0	E0	F0
C1	D1	E1	F1
C2	D2	E2	F2
C3	D3	E3	F3
C4	D4	E4	F4
C5	D5	E5	F5
C6	D6	E6	F6
C7	D7	E7	F7
C8	D8	E8	F8
C9	D9	E9	F9
CA	DA	EAA	F0A
CB	DB	EAB	F0B
CC	DC	EAC	F0C
CD	DD	EAD	F0D
CE	DE	EAE	F0E
CF	DF	EAF	F0F

ADDRESS 

GRAPHICS CHARACTER SET

<p>DATA 7 6 5 4 3 2 1 0</p> <p>0 0 0 1 0 2 0 3 0 4 0 5 0 6 0 7 0 8 0 9 0 A 0 B 0 C 0 D 0 E 0 F</p>	<p>DATA 7 6 5 4 3 2 1 0</p> <p>1 0 1 1 1 2 1 3 1 4 1 5 1 6 1 7 1 8 1 9 1 A 1 B 1 C 1 D 1 E 1 F</p>	<p>DATA 7 6 5 4 3 2 1 0</p> <p>J 0 J 1 J 2 J 3 J 4 J 5 J 6 J 7 J 8 J 9 J A J B J C J D J E J F</p>	<p>DATA 7 6 5 4 3 2 1 0</p> <p>3 0 3 1 3 2 3 3 3 4 3 5 3 6 3 7 3 8 3 9 3 A 3 B 3 C 3 D 3 E 3 F</p>
<p>DATA 7 6 5 4 3 2 1 0</p> <p>W 0 W 1 W 2 W 3 W 4 W 5 W 6 W 7 W 8 W 9 W A W B W C W D W E W F</p>	<p>DATA 7 6 5 4 3 2 1 0</p> <p>S 0 S 1 S 2 S 3 S 4 S 5 S 6 S 7 S 8 S 9 S A S B S C S D S E S F</p>	<p>DATA 7 6 5 4 3 2 1 0</p> <p>L 0 L 1 L 2 L 3 L 4 L 5 L 6 L 7 L 8 L 9 L A L B L C L D L E L F</p>	<p>DATA 7 6 5 4 3 2 1 0</p> <p>7 0 7 1 7 2 7 3 7 4 7 5 7 6 7 7 7 8 7 9 7 A 7 B 7 C 7 D 7 E 7 F</p>
<p>DATA 7 6 5 4 3 2 1 0</p> <p>I 0 I 1 I 2 I 3 I 4 I 5 I 6 I 7 I 8 I 9 I A I B I C I D I E I F</p>	<p>DATA 7 6 5 4 3 2 1 0</p> <p>9 0 9 1 9 2 9 3 9 4 9 5 9 6 9 7 9 8 9 9 9 A 9 B 9 C 9 D 9 E 9 F</p>	<p>DATA 7 6 5 4 3 2 1 0</p> <p>A 0 A 1 A 2 A 3 A 4 A 5 A 6 A 7 A 8 A 9 A A A B A C A D A E A F</p>	<p>DATA 7 6 5 4 3 2 1 0</p> <p>B 0 B 1 B 2 B 3 B 4 B 5 B 6 B 7 B 8 B 9 B A B B B C B D B E B F</p>
<p>DATA 7 6 5 4 3 2 1 0</p> <p>C 0 C 1 C 2 C 3 C 4 C 5 C 6 C 7 C 8 C 9 C A C B C C C D C E C F</p>	<p>DATA 7 6 5 4 3 2 1 0</p> <p>D 0 D 1 D 2 D 3 D 4 D 5 D 6 D 7 D 8 D 9 D A D B D C D D D E D F</p>	<p>DATA 7 6 5 4 3 2 1 0</p> <p>E 0 E 1 E 2 E 3 E 4 E 5 E 6 E 7 E 8 E 9 E A E B E C E D E E E F</p>	<p>DATA 7 6 5 4 3 2 1 0</p> <p>F 0 F 1 F 2 F 3 F 4 F 5 F 6 F 7 F 8 F 9 F A F B F C F D F E F F</p>

ADDRESS 

FIRMWARE

For the casual user, not much need be said about the firmware that the board comes equipped with. For the most part, you will be satisfied with the boards performance and much of what it does, why it does it and how to modify it will remain transparent to you. If, however, you enjoy tinkering with register contents and other esoterica, this section will provide you with some very interesting information.

We will begin this section with a discussion of the CRT Controller chip that is the heart of the VIDEOTERM board, the chip's function and how to access its various registers and options. This will be followed by a discussion of how to modify some of the internal registers that your firmware uses.

Firmware Control of the VIDEOTERM Board

Included in a 2708 EPROM on the VIDEOTERM board is the software which controls the CRT Controller and other aspects of character processing. A listing of this 6502 assembly language program begins on page 5-x. A careful study of this listing and its included comments will do much to instruct you on how to access and control the VIDEOTERM from your own assembly language programs.

At the heart of the VIDEOTERM board is the Hitachi HD46505SP CRT Controller IC chip (CRTC). It is the largest chip on the board and occupies a position just to the upper-left of center. While all keyboard operations, cursor movements, read and write operations, and editing are under the 6502 microprocessor unit's (MPU's) control, the CRTC provides all video timing for interfacing to raster scan CRT displays.

The use of static Ram on the VIDEOTERM board relieves the CRTC of the task of memory refresh. Its other features are fully employed. These functions include an internal cursor register which may be altered so that the cursor may be programmed to a unique shape, which allows ready recognition of which program or part of a program is executing. A light pen strobe input signal allows capture of the status of an internal light pen register.

A. CRTC Internal Register Use

The CRTC contains a set of internal registers which are user software programmable. The contents of these registers are regularly scanned by the CRTC to determine such matters as horizontal and vertical raster timing, position of the cursor, cursor size and shape, interlace mode and several other items. Let us see what each of the 18 available registers does.

Horizontal timing of the raster scan is controlled by Registers R0, R1, R2 and R3. These registers control the frequency, position and width of the horizontal sync pulse and the frequency, position and duration of the horizontal display signal. The screen display point of reference for horizontal registers is the left most displayed character position. These registers contain data which is in 'character time' units, determined by the MCM6571A Character Generator. The timing units are given in Table 4 for the various character cell matrix sizes which are available through the "CTRL-Q <params>" character sequence.

R0: An 8-bit write-only register that determines the horizontal frequency which is the total, minus one, of displayed and non-displayed character time units. This is called the Horizontal Total Register.

- R1: An 8-bit write-only register that determines the number of displayed characters per line. This is termed the Horizontal Display Register.
- R2: An 8-bit write-only register that determines the horizontal sync position on the horizontal line. This is termed the Horizontal Sync Position Register.
- R3: A 4-bit write-only register that determines the width of the horizontal sync pulse. This is termed the Horizontal Sync Width Register.

A variety of vertical registers control the vertical sync pulse frequency and position and the vertical display frequency and position. It also generates row selects for interlace or non-interlace modes. The point of reference for the vertical registers is the top character position displayed. These registers are programmed in 'character time' units.

- R4: A 7-bit write-only register that determines the vertical refresh rate in conjunction with R5. The calculated number of character line times is usually an integer plus a fraction to obtain exactly a 50 or 60 Hz vertical refresh rate. The integer number of character line times minus one is entered into this register which is called the Vertical Total Register.
- R5: A 5-bit write-only register contains the fraction needed to obtain, in conjunction with R4, the needed exact 50 or 60 Hz vertical refresh rate. This is called the Vertical Total Adjust Register.
- R6: A 7-bit write-only register determines the

number of displayed character row on the screen (in 'character row' time units. This is called the Vertical Displayed Register.

R7: A 7-bit write-only register determines the vertical sync position with respect to the top reference line. This is called the Vertical Sync Position Register.

R8: A 2-bit write-only register controls the raster scan mode. As long as bit 0 is clear (0), the display is in Normal Sync Mode (non-Interlaced). When bit 0 is set (1), bit 1 determines the mode. If it is clear (0), then Interlace Sync Mode is set. If bit 1 is set (1), then Interlace Sync with Video Mode is set. The Normal Sync Mode is what is normally selected by the VIDEOTERM. Interlace Sync doubles the number of dots, duplicating each dot below its position, thus increasing the quality of the displayed character. Interlace Sync with Video keeps the character dot matrix the same, but doubles the number of lines on the screen so that twice as many characters, each one-half their normal size, are displayed on the screen. This mode should only be chosen if you are using a long-phosphor video monitor. This is called the Interlace Mode Register.

R9: A 5-bit write-only register that determines the number of scan lines per character row including spacing around the character row. This is one less than the number of scan lines. This register is called the Maximum Scan Line Address Register.

There are eight more registers available which affect four other display characteristics. Since

these registers are utilized in pairs, we will describe them in that way.

R10 and R11: The Cursor Start and End Registers, respectively. R10 is a 7-bit and R11 is a 5-bit write-only register. In both, bits 0 to 4 are the start and end row of the cursor. R10, the start row, may be set at any value from 0 to 11 (decimal). R11, the end row, may be set at any value greater than or equal to the start row value. Thus if the start row was 0 and the end row was 11, a full cursor would be displayed, while if the start and end rows were both 11 an underline cursor would be formed. In addition, bits 5 and 6 of R10 are used to set the Cursor Display Mode. If bit 6 is clear (0), the cursor will not blink, while if it is set (1), it will blink at a rate determined by bit 5. If bit 6 is clear then the status of bit 5 determines if there is a cursor displayed (cleared or 0) or not (set or 1). When bit 6 is set and bit 5 is clear (0), you set a 1/16th field rate blink. When bit 5 is set, you obtain a 1/32nd field rate blink. You can set these registers so that you can obtain a wide variety of customized and individually recognizable cursors which can greatly aid you in identifying which software program is currently running.

R12 and R13: These are the high and low, respectively, addresses for determining where to start writing on the screen. You should not change or utilize these registers in any way as you will interfere with the scrolling operation of the VIDEOTERM. R12 is a 6-bit and R13 is an 8-bit pair of write-only registers called the Start Address Register.

R14 and R15: These are high and low, respectively, address components of a 14-bit address determining the current cursor location. You do not need to access these locations directly, but may reposition the cursor through the use of the

"SHIFT-CTRL-N <x> <y>" sequence where the x and y screen coordinates, in ASCII character codes are given in place of the angle brackets. R14 is a 6-bit and R15 is an 8-bit pair of read/write registers called the Cursor Register.

R16 and R17: These are high and low, respectively, address components of a 14-bit address which is stored when the Light Pen strobe goes high. The address which is stored is the CRT Address Counter. R16 is a 6-bit and R17 is an 8-bit pair of read-only registers.

Table 4 on the following page summarizes this information and gives the standard VIDEOTERM default values used with its various character cell matrix sizes.

Table 4: CRTC Register Assignments

Register Number	Register file description	Read	Write	9 x 9	9 x 12
R0	Horizontal Total	No	Yes	\$7B	\$7B
R1	Horizontal Displayed	No	Yes	\$50	\$50
R2	Horizontal Sync Position	No	Yes	\$62	\$62
R3	Horizontal Sync Width	No	Yes	\$29	\$29
R4	Vertical Total	No	Yes	\$1B	\$14
R5	Vertical Adjust	No	Yes	\$08	\$08
R6	Vertical Displayed	No	Yes	\$18	\$12
R7	Vertical Sync Position	No	Yes	\$19	\$13
R8	Interlace Mode	No	Yes	\$00	\$00
R9	Maximum Scan Line Address	No	Yes	\$08	\$0B
R10	Cursor Start	No	Yes	\$C0	\$C0
R11	Cursor End	No	Yes	\$08	\$0B
R12	Start Address (High)	No	Yes	\$00	\$00
R13	Start Address (Lower)	No	Yes	\$00	\$00
R14	Cursor (High)	Yes	Yes	\$00	\$00
R15	Cursor (Low)	Yes	Yes	\$00	\$00
R16	Light Pen (High)	Yes	No		
R17	Light Pen (Low)	Yes	No		

B. How to Modify CRTC Registers

Now that you know what the various registers are, you undoubtedly want to know how to modify their contents. To do this you must place two values into specific Apple II memory locations. The first value is the register number, in hexadecimal, that you wish to write into and the second value is the new value to be entered. Thus, if you wanted to change the cursor to a non-blinking upper half of a cursor five rows thick, you would want to enter "0A 01" and "0B 05" to place line numbers 1 and 5 into R10 and R11, respectively. If you wanted to make this cursor blink, you would enter "0A 61" where the \$61 (decimal 97) indicates that both bits 5 and 6 of the word are set.

But how do you determine the address at which to enter these numbers? This is done using a device select operation, which algorithm is as follows. Your first hex address character must be a 'C' as this is the address space used by Apple II in dealing with its peripherals. The next number must be zero. These are the high address of the device select 16-byte group. The third number will be eight plus the slot number so that if your board is in slot 3 the number will be 'B' in hex. These first three numbers of the correct address are chosen according to Table 3, page 4-7. Also look at Table 25, page 82, in the Apple II Reference Manual. The last number of the four is either a '0' or '1'. Enter the CRTC Register to be changed using '0' and the value to be placed in that register using '1'. Let us continue with our cursor modification example above and enter the correct information, assuming that you have the VIDEOTERM in slot 3. Enter the Monitor by typing

CALL -154 (CR)

Then enter

*COB0:0A (CR)
*COB1:01 (CR)
*COB0:0B (CR)
*COB1:05 (CR)

You can also enter the information with

*COB0:0A 01 (CR)
*COB0:0B 05 (CR)

You have now set the cursor to a non-blinking, upper-half cursor, five matrix cell rows thick. You have done this by reinitializing registers R10 and R11.

C. Device Select Operation

Device selection is mentioned several times throughout this manual. The calculation of the correct 16-byte device specific group has been demonstrated to be slot dependent. The preceding section should show how to use the device select to modify a CRTC register. However, whenever a "PEEK" or "POKE" command is executed in this group, several things happen. To understand this, we need to describe how the lowest 4 bits of this two-byte address affects the VIDEOTERM. This is the 'x' in the \$COBx address. (For other slots, substitute \$8 + n, where n is the slot number of the VIDEOTERM.)

The very lowest bit, bit 0, controls whether a register is being accessed (0) or the contents of the register is being accessed (1). The next lowest bit, bit 1, controls whether an eight or nine cell matrix width is being used. VIDEOTERM automatically interprets this as 0 (9 cells), so there is no reason to change this.

The next two bits, bits 2 and 3, determine which page will be selected (see VIDEOTERM memory mapping, page 5-12. If the value of both is zero,

page zero is selected, if their value together is one, page one is selected, and so forth. Thus, access of \$COB0 selects for slot 3, a register access and page zero all at once. Similarly, \$COC5 selects for slot 4, register contents access and page one use (bit 2 and bit 0 set).

D. Video Set-Up Flags

Table 1 defined the VIDEOTERM's use of available Apple II RAM scratchpad locations. Location \$7F8 (decimal 2040) was defined as being used as video set-up flags. These flags will be explained here.

Each word of storage in the Apple II contains 8 bits. The bit locations in the word are identified by a number between 0 and 7, with bit 0 the bit furthest to the right in the word (representing the 1's place) and bit 7 is the furthest to the right (representing the 128's place, i.e. 2^7). Only 4 of the 8 bits are used as flags.

- Bit 0: Alternate character set flag. When set to 0, it selects the standard character set. When set to 1, it selects the alternate character set. If you have the modified the VIDEOTERM to use its inverse video option, then the setting of 0 selects for standard video and 1 selects for an inverse character (black on white field).
- Bit 4: Number of rows flag. When set to 0, it selects for display of 18 lines of text. When set to 1, it selects for display of 24 lines of text.
- Bit 6: Upper/lower case flag. When set to 0, it selects for non-conversion of entered text so that an upper case character (all that you can type directly from the keyboard) will remain upper case. When set to 1, it

selects for conversion of the entered character to lower case. This flag is toggled by the "CTRL-A" entry.

Bit 7: GETLN flag. When set to 0 it indicates that the VIDEOTERM input came from a "GET" statement. When set to 1, it indicates that your input has resulted from use of the Apple's GETLN routine, which means input came from a program's "INPUT" statement or directly from the keyboard. The behaviour of this routine is fully documented in the Apple II Reference Manual, pages 33-34.

VIDEOTERM Memory Mapping

As explained in the Apple II Reference Manual on pages 84 and 85, the Apple II address range from \$C800 to \$CFFF is reserved for mapping into 2K of EPROM memory located on a peripheral card. Which card, determined by its slot location, is referenced by these addresses is determined by the "PR#n" statement.

For the VIDEOTERM, the 1K range from \$C800 to \$CBFF is used to access the controlling firmware on the board. The address range from \$CC00 to \$CDFF is used to address the VIDEOTERM's on-board RAM. The range from \$CE00 to \$CFFF is not presently used.

The address range from \$CC00 to \$CDFF only covers 512 bytes of storage. Since the VIDEOTERM HAS 2K of on-board RAM, four times the address range, it would seem impossible to access all of the on-board memory! To overcome this apparent limitation, a technique called "paging" is used.

Basically, paging works as follows. The 2048 byte RAM area is subdivided into four 512-byte segments, each called a "page". Once the VIDEOTERM is activated by the correct memory reference, it will automatically set the correct active page. You then write the character that you want displayed to the relative address within the 512-byte group. This is called a "page-relative address" and may be calculated by taking the 2048-byte address modulo 512. Then write the character you want displayed to that address.

Let us review the process as you would implement it in one of your programs. Determine the address within the 2048 byte on-board RAM that you wish to access. This technique is illustrated in the Applesoft and Integer Basic language software examples in the preceding chapter on pages 4-12 to

4-23, and reviewed again below. Then execute a "PEEK" on a page-specific address in the reserved peripheral 16-byte group. For slot 3, these addresses would be \$COB0, \$COB4, \$COB8 and \$COBC (49328 TO 49340). This sets the VIDEOTERM's current active page to the correct page. Finally, "POKE" the desired character, represented by its ASCII character code in decimal, into the page-relative address acquired by taking the actual address "MOD 512". You have just placed that character in the VIDEOTERM's on-board memory and you will see the character properly displayed in its chosen position on your monitor screen.

Note that when you determine the actual 2048 byte address, you must use the current screen start line address stored at $\$6F8 + n = 1784 + n$, where n is the number of the slot in which the VIDEOTERM is located. (See Table 1, page 3-2.) Multiply the contents of this location by 16. Next determine where on the screen you want to place the character. The column number, X , may vary between 0 and 79, and the row number, Y , may vary between 0 and 23. The on-screen location will be $X + 80 * Y$. This will generate a number between 0 and 1919. Add this to the start location times 16. Take this result modulo 2048 to keep it in the correct numerical range. The final algorithm is

$$\text{ADDRESS} = X + Y * 80 + \text{PEEK}(1784 + n) * 16$$

To activate the correct page, take the start address of the 16-byte group dedicated to the slot in which the VIDEOTERM is located. This address is $\$CO80 + n * 16 = 45184 + n * 16$, where n is the slot location. Add to this result the desired page to be activated. This is calculated by taking the above ADDRESS/512. A page number between 0 and 3 is thus calculated. We then multiply by 4 to put this number in bits 2 and 3 (see page 5-9). Lastly, "PEEK" at the address which is the sum of the start address and four times the page number. Thus

```
PAGE = ADDRESS/512
SELECT = PEEK(45184 + n * 16 + PAGE * 4)
```

The correct VIDEOTERM RAM page is now activated, and any character written into the address space \$CC00 (52224) to \$CFFF (53247) will go to the active page.

For Integer Basic, subtract the value 65536 from the above decimal address equivalents to generate the correct negative decimal address equivalent. The peripheral-specific 16-byte address group base addresses are listed in Table 3, page 4-7, for all Apple languages.

:ASM

```
1 *****
2 *
3 *          VIDEOTERM INTERFACE *
4 *          FIRMWARE V. 2.4     *
5 *
6 *   WRITTEN BY DARRELL ALDRICH *
7 *   (C) 1981 VIDEX            *
8 *
9 *****
10 *
11 * ZERO PAGE EQUATES
12 *
13 CH      EQU  $24
14 CV      EQU  $25
15 BASL    EQU  $28
16 XSAVE   EQU  $35
17 CSWL    EQU  $36
18 CSWH    EQU  $37
19 KSWL    EQU  $38
20 KSWH    EQU  $39
21 RNDL    EQU  $4E
22 RNDH    EQU  $4F
23 *
24 * TEMPORARIES
25 *
26 CRFLAG  EQU  $478
27 ASAV1   EQU  $4F8
28 XSAV1   EQU  $578
29 TEMPX   EQU  $5F8
30 OLDCHAR EQU  $678
31 NO      EQU  $6F8
32 MSLOT   EQU  $778
33 *
34 * MISC EQUATES
35 *
36 IN      EQU  $200
37 IORTS   EQU  $FFCB
38 *
39 * SLOT N PERMANENTS
40 *
41 BASEL   EQU  $478      ; SCREEN BASE ADDRESS LOW
42 BASEH   EQU  $4FB      ; SCREEN BASE ADDRESS HIGH
43 CHORZ   EQU  $578      ; CURSOR HORIZONTAL POSITION
44 CVERT   EQU  $5FB      ; CURSOR VERTICAL POSITION
45 BYTE    EQU  $678      ; I/O BYTE FOR PASCAL ENTRIES
46 START   EQU  $6FB      ; SCREEN START ADDRESS
47 POFF    EQU  $778      ; POWER OFF AND LEAD IN COUNTER
48 *
49 * B0,B1 IS GO TO XY LEAD IN COUNTER
50 * B2 IS CONTROL Z LEADIN COUNTER
51 * B3-B7 IS PDWER OFF FLAG
52 *
53 FLAGS   EQU  $7FB      ; VIDEO SET UP FLAGS
54 *
55 * B0 ALTERNATE CHARACTER SET 1=ON 0=OFF
56 * B1
57 * B2
58 * B3
```

```

59 * B4 ROWS OF CHARACTERS 1=24 0=18
60 * B5
61 * B6 LOWER / UPPER CASE CONVERSION FLAG 1=ON 0=OFF
62 * B7 GETLN FLAG 1=INPUT CAME FROM GETLN ROUTINE
63 *
64 *
65 * IO DEVICES
66 *
67 KBD EQU %C000
68 KBOSTRB EQU %C010
69 SPKR EQU %C030
70 DEV0 EQU %C0B0
71 DEV1 EQU %C0B1
72 DISP0 EQU %CC00
73 DISP1 EQU %CD00
74 *
75 ORG %C800
76 OBJ %6800
77 *
78 *
79 * SET UP CRTC AND CLEAR SCREEN
80 *
81 *
C800: AD 7B 07 82 SETUP LDA POFF ; GET POWER OFF FLAG
C803: 29 F8 83 AND %F8 ; STRIP OFF LEAD IN COUNTERS
C805: C9 30 84 CMP %30 ; HAS POWER BEEN TURNED OFF?
C807: F0 21 85 BEQ SETEXIT ; RETURN IF NOT
C809: A9 30 86 RESTART LDA %30
C80B: 8D 7B 07 87 STA POFF ; SET DEFAULTS FOR FLAGS
C80E: 8D FB 07 88 STA FLAGS
C811: A9 00 89 LDA %00
C813: 8D FB 06 90 STA START
C814: 20 61 C9 91 JSR CLSCRN
C819: A2 00 92 LDX %500
C81B: 8A 93 LOOP TXA
C81C: 8D B0 C0 94 STA DEV0 ; FOR THE CRTC ADDRESS
C81F: 8D A1 C8 95 LDA TABLE,X ; GET PRAMETER
C822: 8D B1 C0 96 STA DEV1 ; STORE INTO CRTC
C825: E8 97 INX
C826: E0 10 98 CPX %10
C828: D0 F1 99 BNE LOOP ; CONTINUE LOOP UNTIL DONE
C82A: 8D 59 C0 100 SETEXIT STA %C059
C82D: 60 101 RTS
102 *
103 *
C82E: AD FB 07 104 EXIT LDA FLAGS
C831: 29 08 105 AND %08
C833: F0 09 106 BEQ NORMOUT
C835: 20 93 FE 107 JSR %FE93
C838: 20 22 FC 108 JSR %FC22
C83B: 20 89 FE 109 JSR %FE89
C83E: 68 110 NORMOUT PLA ; RECOVER REGISTERS
C83F: A8 111 TAY
C840: 68 112 PLA
C841: AA 113 TAX
C842: 68 114 PLA
C843: 60 115 RTS
116 *
117 *
118 * GET CHARACTER FROM KEYBOARD

```

```

119 *
C844: 20 D1 C8 120 ROKEY JSR CSRMOV ; POSITION CURSOR
C847: E6 4E 121 KEYIN INC RNOL ; UPDATE BASIC RANDOM NUMBER
C849: D0 02 122 BNE KEYIN2
C84B: E6 4F 123 INC RNDH
C84D: AD 00 C0 124 KEYIN2 LDA KBD ; POLL KEYBOARD
C850: 10 F3 125 BPL KEYIN ; LOOP UNTIL KEY IS STRUCK
C852: 20 5C C8 126 JSR KEYSTAT
C855: 90 F0 127 BCC KEYIN
C857: 2C 10 C0 128 NOKEY BIT KBDSTRB ; CLEAR KEYBOARD STROBE
C85A: 18 129 CLC
C85B: 60 130 RTS
131 *
C85C: C9 8B 132 KEYSTAT CMP #58B ; CHECK FOR CONTROL K
C85E: D0 02 133 BNE NOTK ; SKIP IF NOT
C860: A9 DB 134 LDA #5DB ; SUBSTITUTE A RIGHT BRACKET
C862: C9 81 135 NOTK CMP #81 ; CHECK FOR CONTROL A
C864: D0 0A 136 BNE NTSHFT ; SKIP IF NOT
C866: AD FB 07 137 LDA FLAGS
C869: 49 40 138 EOR #540
C86B: 8D FB 07 139 STA FLAGS ; TOGGLE UPR/LWR CASE FLAG
C86E: B0 E7 140 BGE NOKEY ; GET NEXT KEY
C870: 48 141 NTSHFT PHA ; SAVE CHARACTER
C871: AD FB 07 142 LDA FLAGS
C874: 0A 143 ASL
C875: 0A 144 ASL ; CHECK UPR/LWR CASE CONVERSION FLAG

C876: 68 145 PLA ; RESTORE CHARACTER
C877: 90 1F 146 BCC INDONE ; DON'T CONVERT IF FLAG CLEAR
C879: C9 80 147 CMP #5B0
C87B: 90 1B 148 BLT INDONE ; DON'T CONVERT SPECIAL CHARACTERS
C87D: 2C 63 C0 149 BIT %C063
C880: 30 14 BMI NOSHIFT
C882: C9 B0 151 CMP #"0"
C884: F0 0E 152 BEQ ZERO
C886: C9 C0 153 CMP #"@"
C888: D0 02 154 BNE NOT@
C88A: A9 D0 155 LDA #"P"
C88C: C9 DB 156 NOTE CMP #"["
C88E: 90 08 157 BLT INDONE
C890: 2F CF 158 AND #5CF
C892: D0 04 159 BNE INDONE
C894: A9 D0 160 ZERO LDA #"J"
C896: 09 20 161 NOSHIFT ORA #520
C898: 48 162 INDONE PHA ; DUPLICATE CHARACTER
C899: 29 7F 163 AND #57F ; STRIP OFF HIGH BIT
C89B: 8D 7B 06 164 STA BYTE ; SAVE FOR PASCAL
C89E: 68 165 PLA ; RECOVER FOR BASIC
C89F: 38 166 SEC
C8A0: 60 167 RTS
168 *

C8A1: 7B 50 5E
C8A4: 29 1B 08
C8A7: 1B 19 169 TABLE HEX 7B505E291B081819
C8A9: 00 08 E0
C8AC: 08 00 00
C8AF: 00 00 170 HEX 0008E00800000000
171 *
172 *
173 * SECONDARY BASIC OUTPUT ROUTINE

```

```

174 *
175 *
C8B1: 8D 7B 06 176 BASOUT1 STA BYTE ; SAVE CHARACTER
C8B4: A5 25 177 LDA CV ; PERFORM VTAB
C8B6: CD FB 05 178 CMP CVERT
C8B9: F0 06 179 BEQ CVDK
C8BB: 8D FB 05 180 STA CVERT
C8BE: 20 04 CA 181 JSR VTAB
C8C1: A5 24 182 CVDK LDA CH ; PERFORM HTAB
C8C3: CD 7B 05 183 CMP CHORZ
C8C6: 90 03 184 BCC PSCLOUT
C8C8: 8D 7B 05 185 STA CHORZ
C8CB: AD 7B 06 186 PSCLOUT LDA BYTE ; GET CHARACTER
C8CE: 20 89 CA 187 JSR OUTPT1 ; OUTPUT CHARACTER
C8D1: A9 0F 188 CSRMOV LDA ##0F ; SET UP CRTIC ADDRESS
C8D3: 8D 80 C0 189 STA DEV0 ; FOR CURSOR LOW ADDRESS
C8D6: AD 7B 05 190 LDA CHORZ ; CALCULATE ADDRESS
C8D9: C9 50 191 CMP #80
C8DB: 8D 13 192 BCS RTS6
C8DD: 6D 7B 04 193 ADC BASEL
C8E0: 8D B1 C0 194 STA DEV1 ; SAVE ADDRESS
C8E3: A9 0E 195 LDA ##0E ; SET UP CRTIC ADDRESS
C8E5: 8D B0 C0 196 STA DEV0 ; FOR CURSOR HIGH ADDRESS
C8E8: A9 00 197 LDA ##00 ; CALCULATE ADDRESS
C8EA: 6D FB 04 198 ADC BASEH
C8ED: 8D B1 C0 199 STA DEV1 ; SAVE ADDRESS
C8F0: 60 200 RTS6 RTS
201 *
202 *
203 * PERFORM ESCAPE FUNCTIONS
204 *
C8F1: 49 C0 205 ESC1 EOR ##C0
C8F3: C9 08 206 CMP ##08
C8F5: 8D 1D 207 BGE RTS3
C8F7: A8 208 TAY
C8F8: A9 C9 209 LDA #>BELL
C8FA: 48 210 PHA
C8FB: B9 F2 CB 211 LDA ESCRBL,Y
C8FE: 48 212 PHA
C8FF: 60 213 RTS
214 *
C900: EA 215 NOP
216 *
C901: AC 7B 05 217 CLREOL LDY CHORZ ; PUT CURSOR HORIZONTAL INTO Y
C904: A9 A0 218 CLEOL2 LDA ##A0 ; USE A SPACE
C906: 20 71 CA 219 CLEOL2 JSR CHRPUT ; PUT CHARACTER ON SCREEN
C909: C8 220 INY
C90A: C0 50 221 CPY #80 ; CONTINUE UNTIL
C90C: 90 FB 222 BLT CLEOL2 ; Y >= 80
C90E: 60 223 RTS
224 *
C90F: A9 34 225 LEADIN LDA ##34 ; SET LEAD IN BIT
C911: 8D 7B 07 226 PSAVE STA POFF
C914: 60 227 RTS3 RTS
C915: A9 32 228 GOXY1 LDA ##32 ; SET LEADIN COUNT TO 2
C917: D0 F8 229 BNE PSAVE
230 *
C919: A0 C0 231 BELL LDY ##C0 ; BEEP THE SPEAKER
C91B: A2 80 232 BELL1 LDX ##80
C91D: CA 233 BELL2 DEY

```

```

C91E: D0 FD 234      BNE BELL2
C920: AD 30 C0 235      LDA SPKR
C923: 88 236      DEY
C924: D0 F5 237      BNE BELL1
C926: 60 238      RTS
      239
      240
      241 * STORE CHARACTER ON SCREEN AND ADVANCE CURSOR
      242 *
C927: AC 7B 05 243      STOADV LDY CHORZ
C92A: C0 50 244      CPY #80
C92C: 90 05 245      BCC NOT81
C92E: 48 246      PHA
C92F: 20 B0 C9 247      JSR CRLF
C932: 68 248      PLA
C933: AC 7B 05 249      NOT81 LDY CHORZ
C936: 20 71 CA 250      JSR CHRPUT ; PLACE CHARACTER ON SCREEN
C939: EE 7B 05 251      ADVANCE INC CHORZ ; INCREMENT CURSOR HORIZONTAL INDEX
C93C: 2C 78 04 252      BIT CRFLAG
C93F: 10 07 253      BPL RTS8
C941: AD 7B 05 254      LDA CHORZ
C944: C9 50 255      CMP #80
C946: B0 68 256      BCS CRLF
C948: 60 257      RTS8 RTS
      258 *
      259 * CLEAR TO END OF PAGE
      260 *
C949: AC 7B 05 261      CLREOP LDY CHORZ ; GET CURSOR HORIZONTAL INTO Y
C94C: AD FB 05 262      LDA CVERT ; GET CURSOR VERTICAL INTO A
C94F: 48 263      CLEOP1 PHA ; SAVE CURRENT LINE ON STACK
C950: 20 07 CA 264      JSR VTABZ ; CALCULATE BASE ADDRESS
C953: 20 04 C9 265      JSR CLEOLZ ; CLEAR TO END OF LINE, SET CARRY
C956: A0 00 266      LDY #00 ; CLEAR FROM HORIZONTAL INDEX 0
C958: 68 267      PLA
C959: 69 00 268      ADC #00 ; INCREMENT CURRENT LINE (C=1)
C95B: C9 18 269      CMP #24 ; DONE TO BOTTOM OF WINDOW?
C95D: 90 F0 270      BCC CLEOP1 ; IF NOT KEEP CLEARING LINES
C95F: B0 23 271      BCS JVTAB ; VERTICAL TAB TO CURSOR POSITION
      272 *
      273 *
      274 * CLEAR SCREEN
      275 *
C961: 20 67 C9 276      CLSCRN JSR HOME ; HOME CURSOR
C964: 98 277      TYA
C965: F0 E8 278      BEQ CLEOP1 ; CLEAR TO END OF PAGE
      279 *
      280 * HOME CURSOR
      281 *
C967: A9 00 282      HOME LDA #00 ; SET CURSOR POSITION TO 0,0
C969: 8D 7B 05 283      STA CHORZ
C96C: 8D FB 05 284      STA CVERT
C96F: A8 285      TAY
C970: F0 12 286      BEQ JVTAB ; VERTICAL TAB TO CURSOR POSITION
      287 *
C972: CE 7B 05 288      BS DEC CHORZ ; DECREMENT CURSOR HORIZONTAL INDEX
C973: 10 9D 289      BPL RTS3 ; IF POS, OK. ELSE MOVE UP
C977: A9 4F 290      LDA #79 ; SET CURSOR HORIZONTAL TO
C979: 8D 7B 05 291      STA CHORZ ; RIGHTMOST SCREEN POSITION
      292 *
      293 * MOVE CURSOR UP

```

```

294 *
C97C: AD FB 05 295 UP LDA CVERT ; GET CURSOR VERTICAL INDEX
C97F: F0 93 296 BEQ RTS3 ; IF TOP LINE THEN RETURN
C981: CE FB 05 297 DEC CVERT ; DECREMENT CURSOR VERTICAL INDEX
C984: 4C 04 CA 298 JVTAB JMP VTAB ; VERTICAL TAB TO CURSOR POSITION
299 *
300 *
C987: A9 30 301 NOTGOXY LDA ##30 ; CLEAR LEAD IN BITS
C989: 8D 7B 07 302 STA POFF
C98C: 68 303 PLA ; RECOVER CHARACTER
C98D: 09 80 304 ORA ##80
C98F: C9 B1 305 CMP #"1"
C991: D0 67 306 BNE NOT0
C993: A9 08 307 LDA ##08
C995: 8D 58 C0 308 STA %C058
C998: D0 58 309 BNE FLGSET
310 *
C99A: C9 B2 311 NOT1 CMP #"2"
C99C: D0 51 312 BNE NOT2
C99E: A9 FE 313 LOLITE LDA ##FE
C9A0: 2D FB 07 314 FLGCLR AND FLAGS
C9A3: 8D FB 07 315 FLGSAV STA FLAGS
C9A6: 60 316 RTS
317 *
318 *
319 *
320 * PASCAL OUTPUT ENTRY POINT
321 *
322 *
C9A7: 8D 7B 06 323 PSOUT STA BYTE
C9AA: 4E 78 04 324 LSR CRFLAG
C9AD: 4C C8 C8 325 JMP PSCLOUT ; JUMP FOR PASCAL ENTRY
326 *
327 *
328 * CR LF ROUTINE
329 *
C9B0: 20 27 CA 330 CRLF JSR CR
C9B3: EE FB 05 331 LF INC CVERT ; INCREMENT CURSOR VERTICAL
C9B6: AD FB 05 332 LDA CVERT
C9B9: C9 18 333 CMP #24 ; OFF SCREEN?
C9BB: 90 4A 334 BCC VTABZ ; IF NOT MOVE CURSOR
C9BD: CE FB 05 335 DEC CVERT ; IF SO DECREMENT CURSOR VERTICAL
336 *
C9C0: AD FB 06 337 LDA START ; INCREMENT THE START ADDRESS
C9C3: 69 04 338 ADC ##04 ; BY ONE LINE
C9C5: 29 7F 339 AND ##7F
C9C7: 8D FB 06 340 STA START
C9CA: 20 12 CA 341 JSR BASCLC1 ; CALCULATE THE START ADDRESS
C9CD: A9 0D 342 LDA ##0D ; SET UP CRTC ADDRESS
C9CF: 8D B0 C0 343 STA DEV0 ; FOR START LOW ADDRESS
C9D2: AD 7B 04 344 LDA BASEL ; GET START LOW
C9D5: 8D B1 C0 345 STA DEV1 ; SAVE START LOW
C9D8: A9 0C 346 LDA ##0C ; SET UP CRTC ADDRESS
C9DA: 8D B0 C0 347 STA DEV0 ; FOR START HIGH ADDRESS
C9DD: AD FB 04 348 LDA BASEH ; GET START HIGH
C9E0: 8D B1 C0 349 STA DEV1 ; SAVE START HIGH
C9E3: A9 17 350 LDA #23 ; PUT WINDOW BOTTOM-1 INTO A
C9E5: 20 07 CA 351 JSR VTABZ ; CALCULATE BASE ADDRESS
C9E8: A0 00 352 LDY ##00
C9EA: 20 04 C9 353 JSR CLEDLZ ; CLEAR BOTTOM LINE

```



```

C9ED: B0 95 354 BCS JVTAB ; MOVE CURSOR BACK
      355 *
C9EF: C9 B3 356 NOT2 CMP #"3"
C9F1: D0 0E 357 BNE JSTOADV
C9F3: A9 01 358 HILITE LDA #*01
C9F5: 0D FB 57 359 FLGSET DRA FLAGS
C9F8: D0 A1 360 BNE FLGSAV
      361 *
      362 *
      363 * BASIC INITIAL I/O ENTRY POINT
      364 *
      365 *
      366 *
C9FA: C9 B0 367 NOT0 CMP #"0"
C9FC: D0 9C 368 BNE NOT1
C9FE: 4C 09 C8 369 JMP RESTART
      370 *
CA01: 4C 27 C9 371 JSTOADV JMP STOADV
      372 *
CA04: AD FB 05 373 VTAB LDA CVERT ; GET CURSOR VERTICAL
CA07: 8D FB 04 374 VTABZ STA ASAV1 ; MULTIPLY A BY 5
CA0A: 0A 375 ASL
CA0B: 0A 376 ASL
CA0C: 6D FB 04 377 ADC ASAV1
CA0F: 6D FB 06 378 ADC START ; ADD START
CA12: 48 379 BASCLC1 PHA ; SAVE A
CA13: 4A 380 LSR ; CALCULATE BASEH
CA14: 4A 381 LSR
CA15: 4A 382 LSR
CA16: 4A 383 LSR
CA17: 8D FB 04 384 STA BASEH
CA1A: 68 385 PLA ; RECOVER A
CA1B: 0A 386 ASL ; CALCULATE BASEL
CA1C: 0A 387 ASL
CA1D: 0A 388 ASL
CA1E: 0A 389 ASL
CA1F: 8D 7B 04 390 STA BASEL
CA22: 60 391 RTS2 RTS
      392 *
      393 *
CA23: C9 0D 394 VIDOUT CMP #*0D
CA25: D0 06 395 BNE VDDUT1
CA27: A9 00 396 CR LDA #*00
CA29: 8D 7B 05 397 STA CHORZ
CA2C: 60 398 RTS
CA2D: 09 80 399 VDDUT1 ORA #*80 ; SET HIGH BIT
CA2F: C9 A0 400 CMP #*A0
CA31: B0 CE 401 BGE JSTOADV ; IF NOT CONTROL PRINT IT
CA33: C9 87 402 CMP #*87
CA35: 90 08 403 BLT RTS4 ; CTRL @ - F
CA37: A8 404 TAY
CA38: A9 C9 405 LDA #>BELL
CA3A: 48 406 PHA
CA3B: B9 B9 C9 407 LDA CTLTBL-*$87,Y
CA3E: 48 408 PHA
CA3F: 60 409 RTS4 RTS
      410 *
CA40: 18 411 CTLTBL DFB BELL-1
CA41: 71 412 DFB BS-1
CA42: 13 413 DFB RTS3-1

```

CA43:	B2	414	DFB	LF-1	
CA44:	48	415	DFB	CLREOP-1	
CA45:	60	416	DFB	CLSCRN-1	
CA46:	AF	417	DFB	CRLF-1	
CA47:	9D	418	DFB	LDLITE-1	
CA48:	F2	419	DFB	HILITE-1	
CA49:	13	420	DFB	RTS3-1	
CA4A:	13	421	DFB	RTS3-1	
CA4B:	13	422	DFB	RTS3-1	
CA4C:	13	423	DFB	RTS3-1	
CA4D:	13	424	DFB	RTS3-1	
CA4E:	13	425	DFB	RTS3-1	
CA4F:	13	426	DFB	RTS3-1	
CA50:	13	427	DFB	RTS3-1	
CA51:	13	428	DFB	RTS3-1	
CA52:	66	429	DFB	HOME-1	
CA53:	0E	430	DFB	LEADIN-1	
CA54:	13	431	DFB	RTS3-1	
CA55:	38	432	DFB	ADVANCE-1	
CA56:	00	433	DFB	CLREOL-1	
CA57:	14	434	DFB	GOXY1-1	
CA58:	7B	435	DFB	UP-1	
		436	*		
		437	*	CALCULATE SCREEN ADDRESS AND SWITCH IN CORRECT PAGE	
		438	*		
		439	*		
CA59:	18	440	PSNCALC	CLC	
CA5A:	98	441		TYA	
CA5B:	6D 7B 04	442		ADC BASEL	
CA5E:	48	443		PHA	
CA5F:	A9 00	444		LDA ##00	; CALCULATE SCREEN ADDRESS HIGH
CA61:	6D FB 04	445		ADC BASEH	
CA64:	48	446		PHA	
CA65:	0A	447		ASL	
CA66:	29 0C	448		AND ##0C	; USE BIT 0 AND 1 FOR PAGING
CA68:	AA	449		TAX	
CA69:	BD B0 C0	450		LDA DEV0,X	; SET CORRECT SCREEN PAGE
CA6C:	68	451		PLA	
CA6D:	4A	452		LSR	
CA6E:	68	453		PLA	
CA6F:	AA	454		TAX	
CA70:	60	455		RTS	
		456	*		
		457	*		
		458	*	PUT A CHARACTER AT CVERT, CHORZ	
		459	*		
		460	*		
CA71:	0A	461	CHRPUT	ASL	
CA72:	48	462		PHA	; SAVE SHIFTED CHARACTER
CA73:	AD FB 07	463		LDA FLAGS	; GET CHARACTER SET FLAG
CA76:	4A	464		LSR	; SHIFT IT INTO CARRY
CA77:	68	465		PLA	; RECOVER SHIFTED CHARACTER
CA78:	6A	466		ROR	; ROTATE CARRY INTO CHARACTER
CA79:	48	467		PHA	; SAVE CHARACTER
CA7A:	20 59 CA	468		JSR PSNCALC	; SET UP SCREEN ADDRESS
CA7D:	68	469		PLA	; RECOVER CHARACTER
CA7E:	B0 05	470		BCS WRITE1	; SELECT MEMORY RANGE
CA80:	9D 00 CC	471		STA DISP0,X	; STORE CHARACTER ON SCREEN
CA83:	90 03	472		BCC WSKIP	; SKIP
CA85:	9D 00 CD	473	WRITE1	STA DISP1,X	; STORE CHARACTER ON SCREEN

```

CAB8: 60      474 WSKIP  RTS           ; RECOVER X REGISTER
          475 *
          476 *
          477 * GENERAL OUTPUT ROUTINE
          478 *
          479 *
CAB9: 48      480 OUTPT1 PHA           ; SAVE CHARACTER
CAB8A: A9 F7  481 LDA    #F7
CAB8C: 20 A0 C9 482 JSR  FLGCLR
CAB8F: 8D 59 C0 483 STA  %C059
CA92:  AD 78 07 484 LDA  POFF
CA93:  29 07  485 AND  #07           ; CHECK FOR LEAD IN
CA97:  D0 04  486 BNE  LEAD           ; BRANCH IF LEAD IN
CA99:  68      487 PLA           ; RECOVER CHARACTER
CA9A:  4C 23 CA 488 JMP  VIDOUT        ; OUTPUT CHARACTER
          489 *
CA9D:  29 04  490 LEAD  AND  #04           ; CHECK FOR GO TO XY
CA9F:  F0 03  491 BEQ  GOXY3         ; IF NOT SKIP
CAA1:  4C 87 C9 492 JMP  NOTGOXY
CAA4:  68      493 GOXY3  PLA           ; RECOVER CHARACTER
CAA5:  38      494 SEC
CAA6:  E9 20  495 SBC  #20           ; SUBTRACT 32
CAA8:  29 7F  496 GOTOXY AND  #7F        ; STRIP OFF UNEEDED BITS
CAA9:  48      497 PHA           ; SAVE A
CAAB:  CE 78 07 498 DEC  POFF         ; DECREMENT LEAD IN COUNTER
CAAE:  AD 78 07 499 LDA  POFF
CAB1:  29 03  500 AND  #03           ; GET COUNT
CAB3:  D0 15  501 BNE  GOXY2        ; SKIP IF COUNT NOT ZERO
CAB5:  68      502 PLA           ; RECOVER A
CAB6:  C9 18  503 CMP  #24           ; IF A > WINDOW BOTTOM
CAB8:  B0 03  504 BGE  BADC          ; THEN DON'T MOVE CURSOR VERTICAL
CABA:  8D FB 05 505 STA  CVERT
CABD:  AD FB 05 506 BADC  LDA  TEMPX   ; GET CURSOR HORIZONTAL PARAMETER
CAC0:  C9 50  507 CMP  #80           ; IF A > 80 THEN
CAC2:  B0 03  508 BGE  BADC          ; DON'T MOVE CURSOR HORIZONTAL
CAC4:  8D 7B 05 509 STA  CHORZ
CAC7:  4C 04 CA 510 BADC  JMP  VTAB    ; VERTICAL TAB TO CURSOR POSITON
CACA:  68      511 GOXY2  PLA           ; RECOVER A
CACB:  8D FB 05 512 STA  TEMPX        ; SAVE CURSOR HORIZONTAL PARAMETER
CACE:  60      513 RTS
          514 *
          515 *
          516 * STOP LIST ROUTINE
          517 *
          518 *
CACF:  AD 00 C0 519 STPLST LDA  KBD
CAD2:  C9 93  520 CMP  #93
CAD4:  D0 0F  521 BNE  STPDONE
CAD6:  2C 10 C0 522 BIT  KBDSTRB
CAD9:  AD 00 C0 523 STPLOOP LDA  KBD
CADC:  10 FB  524 BPL  STPLOOP
CADE:  C9 83  525 CMP  #83
CAE0:  F0 03  526 BEQ  STPDONE
CAE2:  2C 10 C0 527 BIT  KBDSTRB
CAE3:  60      528 STPDONE RTS
          529 *
CAE6:  A8      530 ESCNOW TAY
CAE7:  B9 31 CB 531 LDA  XLTBL-#C9,Y
CAEA:  20 F1 C8 532 JSR  ESC1
CAED:  20 44 C8 533 ESCNEW JSR  RDKEY

```

```

CAF0: C9 CE 534      CMP  ##CE
CAF2: B0 08 535      BGE  ESC2
CAF4: C9 C9 536      CMP  ##C9
CAF6: 90 04 537      BLT  ESC2
CAF8: C9 CC 538      CMP  ##CC
CAFA: D0 EA 539      BNE  ESCNOW
CAFC: 4C F1 C8 540   ESC2  JMP  ESC1
CAFF: EA 541      NOP
      542 *
      543 *
      544 *
      545 *
      546 *
      547 * BASIC INITIAL I/O ENTRY POINT
      548 *
      549 *
CB00: 2C C8 FF 550      BIT  IORTS      ; SET VFLAG ON INITIAL ENTRY
CB03: 70 31 551      BVS  ENTR
CB05: 38 552      INFAKE SEC          ; FAKE INPUT ENTRY C=0
CB06: 90 553      HEX  90
CB07: 18 554      OUTENTR CLC         ; OUTPUT ENTRY C=1
CB08: 88 555      CLV
CB09: 50 2B 556      BVC  ENTR
CB0B: 01 82 557      HEX  0182
CB0D: 11 558      DFB  INIT
CB0E: 14 559      DFB  READ
CB0F: 1C 560      DFB  WRITE
CB10: 22 561      DFB  STATUS
      562 *
CB11: 4C 00 C8 563   INIT  JMP  SETUP
      564 *
CB14: 20 44 C8 565   READ  JSR  RDKEY
CB17: 29 7F 566      AND  ##7F
CB19: A2 00 567      LDX  ##00
CB1B: 60 568      RTS
      569 *
CB1C: 20 A7 C9 570   WRITE JSR  PSOUT
CB1F: A2 00 571      LDX  ##00
CB21: 60 572      RTS
      573 *
CB22: C9 00 574   STATUS CMP  ##00
CB24: F0 09 575      BEQ  STEXIT
CB26: AD 00 C0 576      LDA  KBD
CB29: 0A 577      ASL
CB2A: 90 03 578      BCC  STEXIT
CB2C: 20 5C C8 579      JSR  KEYSTAT
CB2F: A2 00 580   STEXIT LDX  ##00
CB31: 60 581      RTS
      582 *
      583 * BASIC INPUT ENTRY POINT
      584 *
CB32: 91 28 585   INENTR STA  (BASL),Y ; REPLACE FLASHING CURSOR
CB34: 38 586      SEC
CB35: B8 587      CLV
CB36: 8D FF CF 588   ENTR  STA  $CFFF ; TURN OFF CO-RESIDENT MEMORY
      589 *
      590 *
      591 *
      592 * SAVE REGISTERS , SET UP NO AND CN
      593 *

```

```

594 *
CB39: 48 595 WHERE PHA ; SAVE REGISTERS ON STACK
CB3A: 85 35 596 STA XSAVE
CB3C: 8A 597 TXA
CB3D: 48 598 PHA
CB3E: 98 599 TYA
CB3F: 48 600 PHA
CB40: A5 35 601 LDA XSAVE ; SAVE CHARACTER
CB42: 86 35 602 STX XSAVE ; SAVE INPUT BUFFER INDEX
CB44: A2 C3 603 LDX #C3
CB46: 8E 78 04 604 STX CRFLAG
CB49: 48 605 PHA
CB4A: 50 10 606 BVC IO ; GO TO IO IF NOT INITIAL ENTRY
607 *
608 *
609 * BASIC INITIALIZE
610 *
611 *
CB4C: A9 32 612 LDA #<INENTR ; SET UP INPUT AND OUTPUT HOOKS
CB4E: 85 38 613 STA KSWL
CB50: 86 39 614 STX KSWH
CB52: A9 07 615 LDA #<OUTENTR
CB54: 85 36 616 STA CSHL
CB56: 86 37 617 STX CSWH
CB58: 20 00 C8 618 JSR SETUP ; SET UP CRTC
CB5B: 18 619 CLC
620 *
621 *
CB5C: 90 6F 622 IO BCC BASOUT
623 *
624 *
625 * BASIC INPUT ROUTINE
626 *
627 *
CB5E: 68 628 BASINP PLA ; POP STACK
CB5F: A4 35 629 LDY XSAVE ; GET INPUT BUFFER INDEX
CB61: F0 1F 630 BEQ GETLN ; IF ZERO ASSUME GETLN
CB63: 88 631 DEY
CB64: AD 78 06 632 LDA OLDCHAR ; GET LAST CHARACTER FROM GETLN
CB67: C9 88 633 CMP #B8 ; IF BS ASSUME GETLN
CB69: F0 17 634 BEQ GETLN
CB6B: D9 00 02 635 CMP IN,Y
CB6E: F0 12 636 BEQ GETLN
CB70: 49 20 637 EOR #20
CB72: D9 00 02 638 SKIP CMP IN,Y ; IF SAME AS CHARACTER IN INPUT
CB75: D0 38 639 BNE NTGETLN ; BUFFER THEN ASSUME GETLN
CB77: AD 78 06 640 LDA OLDCHAR ; GET LAST CHARACTER FROM GETLN
CB7A: 99 00 02 641 STA IN,Y ; FIX INPUT BUFFER
CB7D: B0 03 642 BGE GETLN ; GO TO GETLN
CB7F: 20 ED CA 643 ESC JSR ESCNEW ; PERFORM ESCAPE FUNCTION
CB82: A9 80 644 GETLN LDA #B0 ; SET GETLN FLAG
CB84: 20 F5 C9 645 JSR FLGSET
CB87: 20 44 C8 646 JSR RDKEY ; GET CHARACTER FROM KEYBOARD
CB8A: C9 98 647 CMP #98 ; CHECK FOR ESCAPE
CB8C: F0 F1 648 BEQ ESC
CB8E: C9 8D 649 CMP #8D ; CHECK FOR CR
CB90: D0 05 650 BNE NOTCR ; IF NOT SKIP
CB92: 48 651 PHA ; SAVE CHARACTER
CB93: 20 01 C9 652 JSR CLREOL ; CLEAR TO END OF LINE
CB96: 68 653 PLA ; RECOVER CHARACTER

```

```

CB97: C9 95 654 NOTCR CMP ##95 ; CHECK FOR PICK
CB99: D0 12 655 BNE NOTPICK ; IF NOT SKIP
CB9B: AC 78 05 656 CHRGET LDY CHORZ ; GET CURSOR HORIZONTAL POSITION
CB9E: 20 59 CA 657 JSR PSNCALC ; SET UP SCREEN ADDRESS
CBA1: B0 05 658 BCS READ1 ; READ CHARACTER FROM SCREEN
CBA3: 8D 00 CC 659 LDA DISPO, X
CBA6: 90 03 660 BCC RSKIP
CBA8: 8D 00 CD 661 READ1 LDA DISPI, X
CBAB: 09 80 662 RSKIP ORA ##80 ; SET HIGH BIT
CBAD: 8D 78 06 663 NOTPICK STA OLDCHAR ; SAVE CHARACTER IN OLDCHAR
CBB0: D0 08 664 BNE DONE ; EXIT
CBB2: 20 44 C8 665 NTGETLN JSR RDKY ; GET CHARACTER FROM KEYBOARD
CBB5: A0 00 666 LDY ##00 ; CLEAR OLDCHARACTER
CBB7: 8C 78 06 667 STY OLDCHAR
668 *
CBBA: BA 669 DONE TSX ; PUT CHARACTER INTO STACK
CBBB: E8 670 INX
CBBE: E8 671 INX
CBBF: E8 672 INX
CBBE: 9D 00 01 673 STA $100, X
CBC1: A9 00 674 OUTDONE1 LDA ##00 ; SET CH = 00
CBC3: 85 24 675 OUTDONE STA CH
CBC5: AD FB 05 676 LDA CVERT ; SET CV = CVERT
CBC8: 85 25 677 STA CV
CBCA: 4C 2E C8 678 JMP EXIT
679 *
680 *
681 * PRIMARY BASIC OUTPUT ROUTINE
682 *
683 *
CBCD: 68 BASOUT PLA ; RECOVER CHARACTER
CBCE: AC FB 07 685 LDY FLAGS ; CHECK GETLN FLAG
CBD1: 10 08 686 BPL BOUT ; IF CLEAR THEN SKIP
CBD3: AC 78 06 687 LDY OLDCHAR ; GET LAST CHARACTER FROM GETLN
CBD6: C0 E0 688 CPY ##E0 ; IF IT IS LOWER CASE THEN USE IT
CBD8: 90 01 689 BLT BOUT
CBDA: 98 690 TYA
CBD8: 20 B1 C8 691 BOUT JSR BASOUT1 ; OUTPUT CHARACTER
CBDE: 20 CF CA 692 JSR STPLST
CBE1: A9 7F 693 LDA ##7F ; CLEAR THE GETLN FLAG
CBE3: 20 A0 C9 694 JSR FLGCLR
CBE6: AD 78 05 695 LDA CHORZ ; GET CURSOR HORIZONTAL
CBE9: E9 47 696 SBC ##47
CBE8: 90 D4 697 BCC OUTDONE1
CBED: 69 1F 698 ADC ##1F
CBEF: 18 699 FIXCH CLC
CBF0: 90 D1 700 BCC OUTDONE
701 *
CBF2: 60 702 ESCTBL DFB CLSCRN-1
CBF3: 38 703 DFB ADVANCE-1
CBF4: 71 704 DFB BS-1
CBF5: B2 705 DFB LF-1
CBF6: 78 706 DFB UP-1
CBF7: 00 707 DFB CLREOL-1
CBF8: 48 708 DFB CLREOP-1
CBF9: 66 709 DFB HOME-1
710 *
CBFA: C4 C2 C1
CBFD: FF C3 711 XLTBL HEX C4C2C1FFC3
712 *

```

```

CBFF: EA      713      NOP
          714 *
CC00: 8D FF CF 715  ROMSW STA  %CFFF
CC03: 8D 00 C3 716      STA  %C300
CC06: 60      717      RTS

```

--END ASSEMBLY--

ERRORS: 0

1031 BYTES

SYMBOL TABLE - ALPHABETICAL ORDER:

ADVANCE	=%C939	ASAV1	=%04F8	BADX	=%CAC7	BADY	=%CABD
BASCLC1	=%CA12	BASEH	=%04F8	BASEL	=%0478	? BASINP	=%CB5E
BASL	=%28	BASOUT	=%CB0C	BASOUT1	=%C8B1	BELL	=%C919
BELL1	=%C91B	BELL2	=%C910	BOUT	=%CB0B	BS	=%C972
BYTE	=%067B	CH	=%24	CHORZ	=%057B	? CHRGET	=%CB9B
CHRPUT	=%CA71	CLEOL2	=%C906	CLEOLZ	=%C904	CLEOP1	=%C94F
CLREOL	=%C901	CLREOP	=%C949	CLSCRN	=%C961	CR	=%CA27
CRFLAG	=%0478	CRLF	=%C9B0	CSRMOV	=%C8D1	CSWH	=%37
CSWL	=%36	CTLTBL	=%CA40	CV	=%25	CVERT	=%05FB
CVOK	=%C8C1	DEV0	=%C0B0	DEV1	=%C0B1	DISP0	=%CC00
DISP1	=%CD00	DONE	=%CB8A	ENR	=%CB36	ESC	=%CB7F
ESC1	=%C8F1	ESC2	=%CAFC	ESCNEW	=%CAED	ESCNOW	=%CAE6
ESCTBL	=%CBF2	EXIT	=%C82E	? FIXCH	=%CBEF	FLAGS	=%07FB
FLGCLR	=%C9A0	FLGSAV	=%C9A3	FLGSET	=%C9F5	GETLN	=%CB82
? GOTOXY	=%CAA8	GOXY1	=%C915	GOXY2	=%CACA	GOXY3	=%CAA4
HILITE	=%C9F3	HOME	=%C967	IN	=%0200	INDONE	=%CB98
INENR	=%CB32	? INFAKE	=%CB05	INIT	=%CB11	IO	=%CB5C
IORTS	=%FFCB	JSTOADV	=%CA01	JVTAB	=%C984	KBD	=%C000
KBDSTRB	=%C010	KEYIN	=%C847	KEYIN2	=%C84D	KEYSTAT	=%CB5C
KSWH	=%39	KSWL	=%38	LEAD	=%CA9D	LEADIN	=%C90F
LF	=%C9B3	LOLITE	=%C99E	LOOP	=%C81B	? MSL0T	=%0778
? NO	=%06F8	NOKEY	=%C857	NORMOUT	=%C83E	NOSHIFT	=%CB96
NOT0	=%C9FA	NOT1	=%C99A	NOT2	=%C9EF	NOT81	=%C933
NOT@	=%C88C	NOTCR	=%CB97	NOTGOXY	=%C987	NOTK	=%CB62
NOTPICK	=%CBAD	NTGETLN	=%CB82	NTSHFT	=%C870	OLDCHAR	=%0678
OUTDONE	=%CB03	OUTDONE1	=%CB01	OUTENR	=%CB07	OUTPT1	=%CA89
POFF	=%077B	PSAVE	=%C911	PSCL0UT	=%C80B	PSNCALC	=%CA59
PSOUT	=%C9A7	ROKEY	=%C844	READ	=%C814	READ1	=%CB8A
RESTART	=%C809	RNDH	=%4F	RNDL	=%4E	? ROMSW	=%CC00
RSKIP	=%CBAB	? RTS2	=%CA22	RTS3	=%C914	RTS4	=%CA3F
RTS6	=%CBF0	RTS8	=%C948	SETEXIT	=%C82A	SETUP	=%CB00
? SKIP	=%CB72	SPKR	=%C030	START	=%06FB	STATUS	=%CB22
STEXIT	=%CB2F	STOADV	=%C927	STPDONE	=%CAE5	STPLOOP	=%CAD9
STPLST	=%CACF	TABLE	=%C8A1	TEMPX	=%05FB	UP	=%C97C
VDOUT1	=%CA2D	VIDOUT	=%CA23	VTAB	=%CA04	VTABZ	=%CA07
? WHERE	=%CB39	WRITE	=%CB1C	WRITE1	=%CA85	WSKIP	=%CA88
XLTL	=%CBFA	? XSAV1	=%0578	XSAVE	=%35	ZERO	=%CB94

SYMBOL TABLE - NUMERICAL ORDER:

CH	=%24	CV	=%25	BASL	=%28	XSAVE	=%35
CSWL	=%36	CSWH	=%37	KSWL	=%38	KSWH	=%39

RNDL	=%4E	RNDH	=%4F	IN	=%0200	CRFLAG	=%0478
BASEL	=%047B	ASAV1	=%04F8	BASEH	=%04FB	? XSAV1	=%0578
CHORZ	=%057B	TEMPX	=%05F8	CVERT	=%05FB	OLDCHAR	=%0678
BYTE	=%067B	? NO	=%06F8	START	=%06FB	? MSL0T	=%0778
POFF	=%077B	FLAGS	=%07FB	KBD	=%C000	KBDSTRB	=%C010
SPKR	=%C030	DEV0	=%C0B0	DEV1	=%C0B1	SETUP	=%C800
RESTART	=%C809	LOOP	=%C81B	SETEXTIT	=%C82A	EXIT	=%C82E
NORMOUT	=%C83E	ROKEY	=%C844	KEYIN	=%C847	KEYIN2	=%C84D
NOKEY	=%C857	KEYSTAT	=%C85C	NOTK	=%C862	NTSHT	=%C870
NOT@	=%C88C	ZERO	=%C894	NOSHIFT	=%C896	INDONE	=%C898
TABLE	=%C8A1	BASOUT1	=%C8B1	CVOK	=%C8C1	PSCL0UT	=%C8CB
CSRMOV	=%C8D1	RTS6	=%C8F0	ESC1	=%C8F1	CLREOL	=%C901
CLEOLZ	=%C904	CLEOL2	=%C906	LEADIN	=%C90F	PSAVE	=%C911
RTS3	=%C914	GOXY1	=%C915	BELL	=%C919	BELL1	=%C91B
BELL2	=%C91D	STOADV	=%C927	NOTB1	=%C933	ADVANCE	=%C939
RTS8	=%C948	CLREOP	=%C949	CLEOP1	=%C94F	CLSCRN	=%C961
HOME	=%C967	BS	=%C972	UP	=%C97C	JVTAB	=%C984
NOTGOXY	=%C987	NOT1	=%C99A	LOLITE	=%C99E	FLGCLR	=%C9A0
FLGSAV	=%C9A3	PSOUT	=%C9A7	CRLF	=%C9B0	LF	=%C9B3
NOT2	=%C9EF	HILITE	=%C9F3	FLGSET	=%C9F5	NOT0	=%C9FA
JSTOADV	=%CA01	VTAB	=%CA04	VTABZ	=%CA07	BASCLC1	=%CA12
? RTS2	=%CA22	VIOOUT	=%CA23	CR	=%CA27	VDOUT1	=%CA2D
RTS4	=%CA3F	CLTBL	=%CA40	PSNCALC	=%CA59	CHRPUT	=%CA71
WRITE1	=%CA85	WSKIP	=%CA88	OUTPT1	=%CA89	LEAD	=%CA9D
GOXY3	=%CAA4	? GOTOXY	=%CAA8	BADY	=%CABD	BADY	=%CAC7
GOXY2	=%CACA	STPLST	=%CACF	STPLOOP	=%CAD9	STPDONE	=%CAE3
ESCNOW	=%CAE6	ESCNEW	=%CAED	ESC2	=%CAFC	? INFAKE	=%CB05
OUTENTR	=%CB07	INIT	=%CB11	READ	=%CB14	WRITE	=%CB1C
? STATUS	=%CB22	STEXIT	=%CB2F	INENTR	=%CB32	ENTR	=%CB36
? WHERE	=%CB39	IO	=%CB5C	? BASINP	=%CB5E	? SKIP	=%CB72
ESC	=%CB7F	GETLN	=%CB82	NOTCR	=%CB97	? CHRGET	=%CB98
READ1	=%CBA8	RSKIP	=%CBAB	NOTPICK	=%CBAD	NTGETLN	=%CBB2
DONE	=%CBB8	OUTDONE1	=%CBC1	OUTDONE	=%CBC3	BASOUT	=%CBCD
BOUT	=%CBDB	? FIXCH	=%CBEF	ESCTBL	=%CBF2	XLTL	=%CBFA
DISP0	=%CC00	? ROMSW	=%CC00	DISP1	=%CD00	IORTS	=%FFCB

HARDWARE OPERATION

Theory of Operation

While reading this section, you should make frequent reference to the labelled photograph of the VIDEOTERM on page A-4 and the schematic of the board included as a fold-out end-paper. Also, you should refer to the description of the board components on page A-3.

In the middle of the schematic and on the left of the board are four chips labelled U-10 to U-14, inclusive. These are the four static Random Access Memory chips which hold the screen display information. Due to their low power needs, they stay relatively cool during board operation and greatly reduce the power needed to drive the VIDEOTERM.

Information may be placed in VIDEOTERM memory by either the user from the Apple II keyboard or by the VIDEOTERM on-board logic. The determination of which has control of memory at any moment is made by the Multiplexer logic, which consists of the three chips labelled U-14, U-15 and U-16. These are located directly below the RAM on the schematic drawing and directly below the CRTC (the largest chip) on the board.

At the heart of the VIDEOTERM is the Hitachi HD 46505SP CRT Controller which has been described more fully in the preceding chapter, pages 5-1 to 5-8. It appears on the right in the schematic and as U-19 in the photograph. It is located, more or less, in the center of the board. The signal from the CRTC drives the 2716 EPROM Character Generator, U-20 in the photograph and in the upper right corner of the schematic. It contains the standard ASCII character set and some special graphics symbols in each of two

character matrix sizes. Accessed by a single 8 bit code, the generator produces a character signal 8 bits long by 16 lines for definition of an upto 8 by 16 character matrix. Next to the character generator is a parallel to serial shift register chip, unit U-21, which is used to actually generate the character matrix dots. When the graphics characters are used, cell 1 contents are copied into cell 0, since the VIDEOTERM actually uses a 9 by 9 character matrix size (9 by 12 with the optional character set).

The 2708 EPROM, labelled U-3 in the photograph and located at the upper left in the schematic, is the firmware chip which holds the VIDEOTERM software listed in the Firmware section starting on page 5-15. When activated, this software controls the VIDEOTERM's response to your keyboard input and other data written to it by the Apple II. The 2708 EPROM labelled U-17 in the photograph and located directly above the RAM in the schematic, contains the optional second character set of 64 characters or 128 characters if you are using a 2716 EPROM. The tri-state inverting buffer, U-24 in the photograph and located in various portions of the schematic, is the optional character set EPROM enable/disable logic circuit.

When the I/O select enables the VIDEOTERM, the address is accessed by the software as well as by the multiplexer. The incoming data is made available to either the CRTC or the memory depending on the state of the latch circuit, U-5 in the photograph and located next to the EPROM firmware in the upper left corner of the schematic. Thus, only one of the two can be accessing memory at any one time: the Apple II data bus or the VIDEOTERM display memory bus. Part of the two to four line decoder, U-9 in the photograph and near U-5 on the schematic, is used to generate the write enable signal for the memory, allowing information to be stored. The other part of this chip's circuit is used to

generate a blank display on the screen while the Apple II is writing into the VIDEOTERM memory.

Two CMOS flip-flop chips, U-7 and U-8 in the photo and located near the bottom of the schematic, control which page of memory (of the four available) is currently being addressed within the range \$C000 to \$CFFF, and if the VIDEOTERM has been activated or inactivated by addressing within the \$C800 to \$CFFF range (according to Apple II Reference Manual specifications; also see pages 5-10 and 5-12ff).

If the VIDEOTERM generated only one character at a time and did the entire job for each one, it would operate at an intolerably slow speed. Thus, a pipeline architecture has been used in the board design. In effect, the board displays the last character while it is setting up for the current character. The data latch, U-18 in the photograph and in the upper right next to the character generator on the schematic, operates in conjunction with the data latch U-5 to control the access timing to the memory. A delay shift register, U-22 in the photograph and to the right of the CRTC in the schematic, operates within this pipeline to correctly delay and coordinate character attribute information. This chip also handles the cursor and display enable signal generated by the CRTC.

In order to drive the board's logic, an on-board clock circuit, entirely separate from the Apple II's clock, is used. This low power circuit is responsible for the VIDEOTERM's excellent character generation. Part of the chip labelled U-4, the chip U-23 and the crystal contained in the aluminum can compose the clock circuit.

The chip labelled U-1 in the photograph allows the cursor to flash on top of another character. Part of this chip is also used for general buffer purposes. Chips U-2 and U-6 are used for general logic circuit purposes.

Shift Wire Mod

The Shift Wire Mod is a hardware modification which allows the shift key to be used normally, provided it has supporting software, such as the firmware in the Videoterm.

Installation of the Shift Wire Mod

Run a wire from pin 24 of the keyboard connector (the pin second farthest away from the power supply on the wire comb which connects the encoder board to the keyboard) to pin 1 of chip location H-14 on the motherboard (which is electrically the same as pin 4 of the game I/O socket (J-14)).

Use of the Shift Wire Mod

The shift wire mod cannot be used in 40 columns without the use of special software. In 80 columns, the Control-A is used to enter the lower case mode (another Control-A will return you to upper case mode). In lower case mode, characters are lower case unless the shift key is used.

The following special characters are also available:

Character	Mode	Description
Left Bracket	Shift Lock	Control-K
Right Bracket	Shift Lock	Shift-M
Left Brace	Shift Unlock	Control-K
Right Brace	Shift Unlock	Shift-0 (zero)

The Soft Video Switch.

The Soft Video Switch is an automatic version of the Switchplate assembly. It will automatically switch to 80 columns when any character is sent to the Videoterm. If any color graphics mode is active, the Soft Video Switch will automatically switch to the 40 column video signal. When the graphics mode is deselected, the Soft Video Switch returns to the previous mode.

Installation and checkout of the Soft Video Switch.

- 1) Turn the Apple][off and remove the cover.
- 2) Locate the I. C. chip F-14 on the motherboard. It is the second chip down from the game I/O socket. The chip is either a 9334 or a 74LS259. Carefully remove this chip with an IC puller or a small flat bladed screwdriver. Set this chip aside.
- 3) Plug the Soft Video Switch into the F-14 socket. The five prong molex connector should face the keyboard. Be sure that all of the pins go into the socket.
- 4) Place the chip that you removed from the F-14 socket into the socket on the Soft Video Switch. The notched end should point toward the keyboard (the same direction as before).
- 5) Plug the three wire cable from the Soft Video Switch onto the four prong video connector on the Apple][motherboard. The cable should be oriented so that the two empty holes at the top of the plug are to the right of the Apple][(i.e. away

from the power supply). Please note the four prong video connector on the Soft Video Switch. This connector is a direct replacement of the video connector on the motherboard (for RF modulators).

- 6) Plug the two wire cable from the Soft Video Switch onto the five pin video connector on the Videoterm.
- 7) Plug the cable supplied with the Videoterm onto the five prong video connector on the Soft Video Switch. This cable should be connected to a monochromatic video monitor.
- 8) Turn your Apple on. If the speaker does not beep upon power up, turn your Apple off and re-check your installation. Pay particular attention to step 4.
- 9) If you have an Autostart ROM, Apple Language Card, or an Apple][plus, goto step 10. Otherwise, your display will probably be blank. If so type the following:

C058 (CR)

- 10) Adjust the 40 column video level adjustment (a little turn dial on the Soft Video Switch) so that you can see the 40 column screen. You should adjust this to be the same strength as the Videoterm's output signal.

Soft Video Switch Theory of Operation.

The Soft Video Switch is controlled by two conditions: the state of annunciator zero and the color killer signal. If the color killer is off,

the Apple][is in its color graphics mode and the Soft Video Switch will always display 40 columns (i.e. graphics). If the color killer is on, the Soft Video Switch follows the state of annunciator zero (set to off by Autostart on power up and reset). If the annunciator is off, the Soft Video Switch displays 40 columns. If the annunciator is on, 80 columns is displayed. The firmware on the Videoterm sets annunciator zero on as EACH character is output. To turn annunciator zero on, a memory reference to \$C058 (-16296) must be made. To turn it off, \$C059 (-16295).

Use of the Soft Video Switch.

To enter 80 columns, type:

PR#3 (CR)

To go back to 40 columns, hit Reset or type a control Z immediately followed by a "1". A control X should be used to prevent an error message in immediate mode. A return is not required.

Decimal:	128	144	160	176	192	208	224	240
Hex:	\$80	\$90	\$A0	\$B0	\$C0	\$D0	\$E0	\$F0
0	\$0	~P	Dle	0	@	P	,	p
1	\$1	~A	Soh	1	A	Q	a	q
2	\$2	~B	Stx	2	B	R	b	r
3	\$3	~C	EtX	3	C	S	c	s
4	\$4	~D	Eot	4	D	T	d	t
5	\$5	~E	Enq	5	E	U	e	u
6	\$6	~F	Ack	6	F	V	f	v
7	\$7	~G	Bel	7	G	W	g	w
8	\$8	~H	Bs	8	H	X	h	x
9	\$9	~I	Ht	9	I	Y	i	y
10	\$A	~J	Lf	:	J	Z	j	z
11	\$B	~K	Vt	;	K	[k	{
12	\$C	~L	Ff	<	L	\	l	
13	\$D	~M	Cr	=	M]	m	}
14	\$E	~N	So	>	N	^	n	~
15	\$F	~O	S1	?	O	_	o	rub

APPENDIX

ASCII CHARACTER CODE CHART

BITS					COL							
b ₄	b ₃	b ₂	b ₁	ROW	0	1	0	0	1	1	1	1
0	0	0	0	0	NUL	DLE	0	0	1	1	1	1
0	0	0	1	1	SOH	DC1	0	1	0	0	1	1
0	0	1	0	2	STX	DC2	0	1	0	0	1	1
0	0	1	1	3	ETX	DC3	2	3	4	5	6	7
0	1	0	0	4	EOT	DC4	SP	0	@	P	\	p
0	1	0	1	5	ENO	NAK	!	1	A	Q	a	q
0	1	1	0	6	ACK	SYN	"	2	B	R	b	r
0	1	1	1	7	BEL	ETB	#	3	C	S	c	s
1	0	0	0	8	BS	CAN	\$	4	D	T	d	t
1	0	0	1	9	HT	EM	%	5	E	U	e	u
1	0	1	0	10	LF	SUB	&	6	F	V	f	v
1	0	1	1	11	VT	ESC	'	7	G	W	g	w
1	1	0	0	12	FF	FS	(8	H	X	h	x
1	1	0	1	13	CR	GS)	9	I	Y	i	y
1	1	1	0	14	SO	RS	*	:	J	Z	j	z
1	1	1	1	15	SI	US	+	;	K	[k	{
							,	<	L	\	l	}
							-	=	M]	m	~
							.	>	N	^	n	~
							/	?	O	_	o	DEL

Notes

TECHNICAL SUMMARY

Board Description

Consult Figure 10, page A-4, for the location of each IC on the VIDEOTERM board. Function of each chip is described in the Theory of Operation section, page 6-1.

<u>Unit No.</u>	<u>Description</u>
U-1	74LS86 Exclusive OR gate, general use
U-2	74LS02 Four NOR gates
U-3	2708 EPROM organized as 8 bits x 1K words
U-4	74LS04 Partly used for clock circuit
U-5	74LS373, 74DP8304, OR 74LS245 - Factory choice
U-6	75LS00 Four NAND gates
U-7	4013 CMOS flip-flops
U-8	4013 CMOS flip-flops
U-9	74LS139 2 TO 4 LINE DECODER
U-10	2114 Static RAM organized as 4 bits x 1K words (low-power)
U-11	2114 Static RAM
U-12	2114 Static RAM
U-13	2114 Static RAM
U-14	74LS157/74LS158 Multiplexer logic use
U-15	74LS157/74LS158 Multiplexer logic use
U-16	74LS157/74LS158 Multiplexer logic use
U-17	2708 or 2716 EPROM containing optional character set, organized either as 8 or 16 bits x 1K words
U-18	74LS273 (Std.) or 74LS374-Factory choice
U-19	Hitachi HD46505SP/Motorola MCM6845 CRT Controller
U-20	2716 EPROM Character generator
U-21	74LS166 Parallel to serial shift register
U-22	74LS175 Delay shift register
U-23	74LS161 System timing clock generator
U-24	74LS368 Tri-state inverting buffer

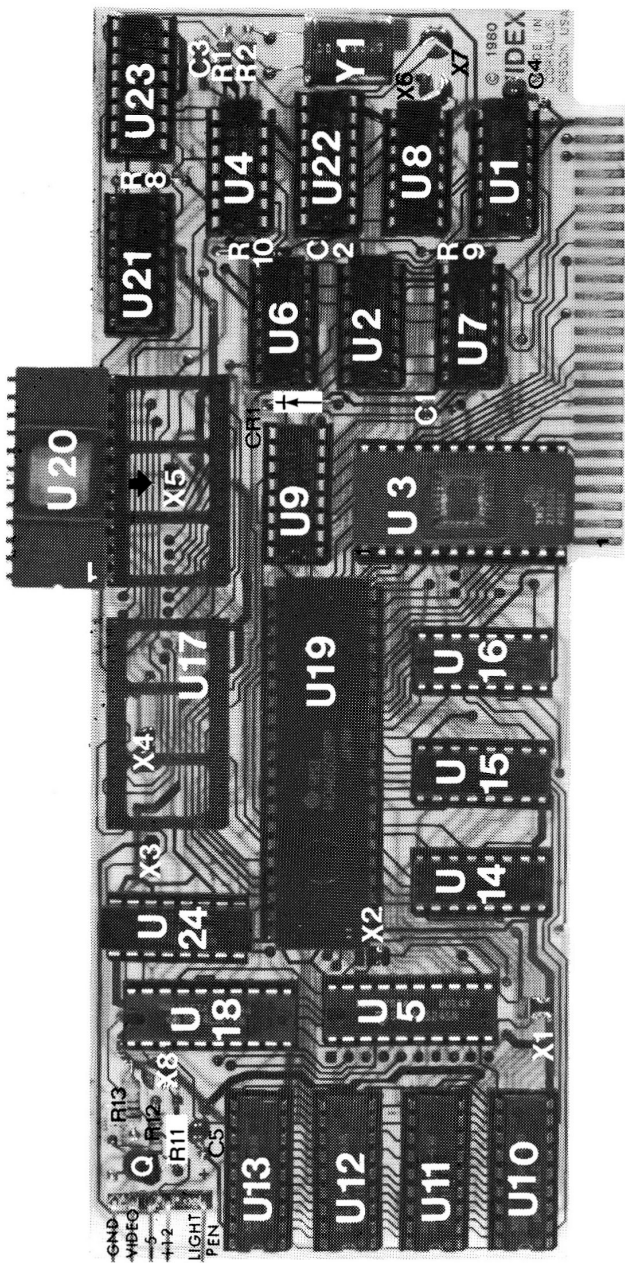
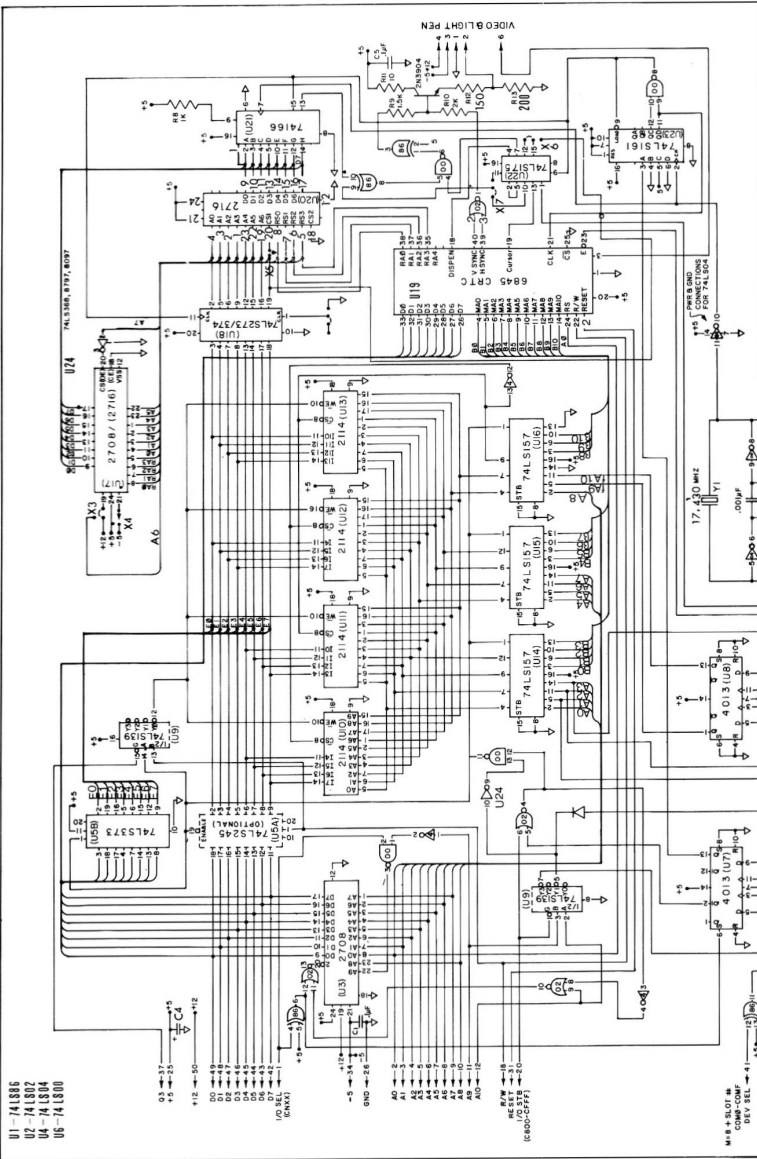

Figure 10: VIDEOTERM Board Photograph



VIDEO TERM
DISPLAY BOARD

VIDEX
3036 NW THISTLE PL.
CORVALLIS, ORE. 97330

DATE: 10 AUG 80
DRAWN BY: L. SPERRY
REV: 010
BY: PAUL DAVIS 1980

- 01-741885
- 02-741802
- 04-741884
- 05-741800

MR. S. BLOTT
CAM-COMP
REV 5EL - 1-1

80-COLUMN IN

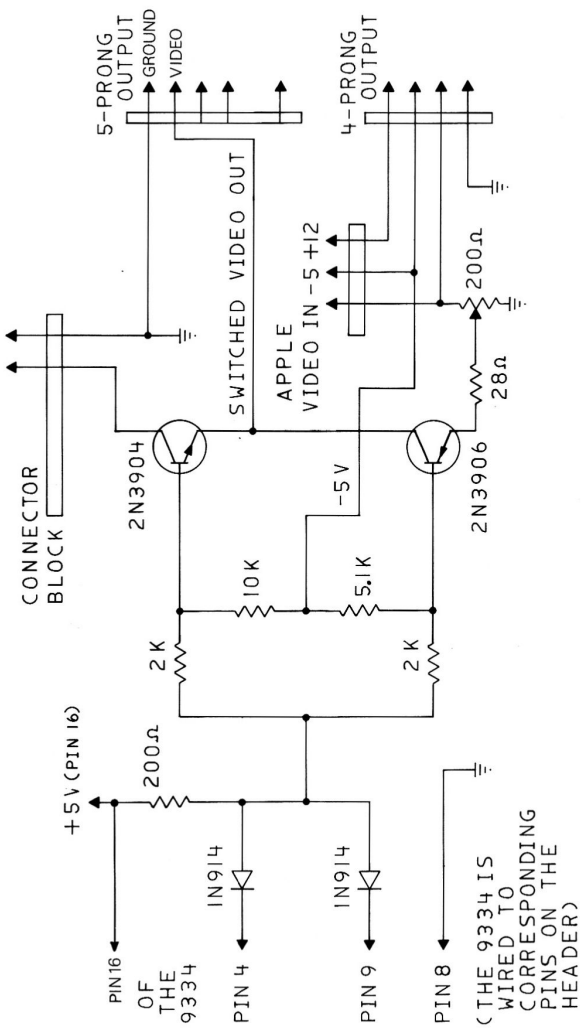

VIDEX INC. SOFT VIDEO SWITCH
897 N.W. GRANT AVE. DATE: ^{FORM BY:} 24 OCT 81 J. BAILEY/SVS-000
CORVALLIS, ORE 97330 © VIDEX INC 1981

Notes

Index

Applesoft	4-3, 4-22
ASCII chart	A-1
Character Sets	4-38 thru 4-41
Control Characters	3-4, 3-5, 3-6 thru 3-10
CRTC	5-1 thru 5-11
Cursor	1-7, 5-5, 5-7
Escape Codes	Errata, 3-9
Firmware	Errata, 5-15
Graphics	3-4, 4-3, 4-4, 4-37, 6-1
Integer BASIC	4-2, 4-13
Inverse	Errata, 3-4
Listing (Firmware)	5-15
Memory mapping	5-12 thru 5-14
Memory usage	3-2, 4-8
Micro Modem	4-31 thru 4-34
Normal video	Errata, 3-4
Parts list	A-3
Pascal	4-4, 4-28
Printers	4-9 thru 4-12
Registers	5-2 thru 5-10
Schematic	A-5
Scratch Pad Usage	3-2
Shift Mod	6-4
Soft Video Switch	Errata, 6-5
Softcard	4-31
Switchplate	Errata, 2-5
Theory of Operation	6-1 thru 6-3

RMA Form for Videoterm VT6(5)

RMA # _____

Call (503-758-0521) for RMA#

Serial # _____

Previous Service RMA _____

Name _____

Shipping Address:

Organization _____

Name _____

Addr. _____

Addr. _____

Shipping Instr. _____

Phone # (days) _____

Phone # (evenings) _____

Date purchased _____

Received _____

System Configuration:

Autostart

Old Monitor ROM

Apple][plus

Apple][

Resident Language:

AppleSoft

Integer

Number of disc drives: _____

List on the back of the page all products installed in the Apple at the time the failure occurred, and any software that was in use.

For problems that occurred during installation, did you get a:

power light?

Display?

power-up beep?

Were there any installation errors?

Describe, in detail, the nature of the problem.

Describe, in detail, the circumstances under which the problem occurred.

Does the problem occur only several minutes after powerup?

Yes No

COMMENTS:



Corvallis, Oregon 97330
503/758-0521