

Apple2000

THE NATIONAL APPLE USERS GROUP



OCTOBER 1988

VOLUME 3(5)

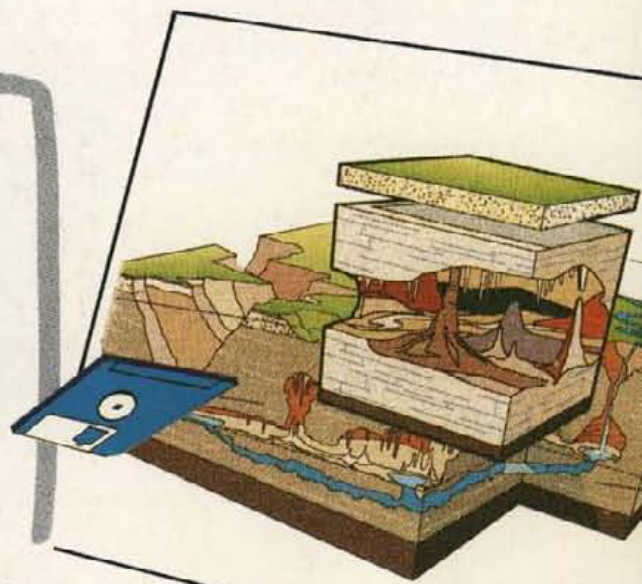

MacUser Show
come and visit us
Stand 133
Business Design Centre
Islington
London
November 8th, 9th, 10th

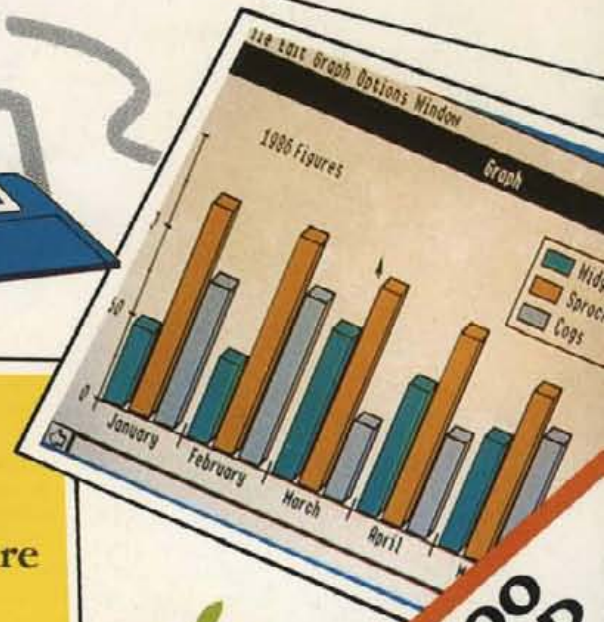

APPLE 2000
RECOMMEND
SONY
DISKETTES

promac
the fastest
hard disks
in the world
MacEurope

promac

All **promac** products share one objective: To be the finest you can buy at any price. No compromises have been made in achieving a thoroughbred design.

Meticulous incoming component inspection, careful manufacture and rigorous quality control, comprehensively tested ROM and firmware to enhance performance, and error-free software combine to achieve our objective.

promac products are elegantly designed and unobtrusive. They are exceedingly fast and very quiet. With the reliability that comes from superior engineering, they meet or exceed all safety and interference standards.

You owe it to yourself to consider **promac** before accepting any other drive. They represent outstanding value. You can't buy faster or better.

MacEurope supports the full range of **promac** professional products, both internal and external. 20MB, 40MB, 50MB, 80MB, 160MB, 300MB, 800MB SCSI disks, each the leader in its category, WORM/CD-ROM, and the infinite capacity **ProDrive**, utilising removeable 10MB floppies. **ProTape** backs up to cassette at 3.3MB/minute. **promac** products are compatible with Unix and all other Macintosh environments.

MacEurope provides engineering, warranty service, support, software updates and advice.

You can see the **promac** range at your MacEurope dealer. If yours doesn't have stock, or you don't have a dealer, please call us. We'll be happy to help. Call us for literature.

promac and **ProDrive** and **ProTape** are registered trademarks of **promac GmbH** Sybelstr 37 1000 Berlin 12 West Germany.

Apple is a trademark of and Macintosh a trademark registered to Apple Computer Inc.

This advertisement prepared by the Robin Ray Partnership on the Macintosh using **JustText** page composition software from MacEurope.

MacEurope

The Granary, Trowse Bridge, Bracondale,
Norwich NR1 2EG, England. Tel: (0603) 630636

Fax: 0603 630374

Apple2000

October 1988

Apple2000
P.O.Box 3,
Liverpool,
L21 8PY

0751 9228 4142

CONTENTS

Editorial	Mick Knapp	2	The Eprom Writer	Martin Randall	39
Delivery Problems	Mick Knapp	3	Mac2000	Norah Arnold	41
Dealer Profile	Mick Knapp	4	Music Mouse		44
Letters		5	LaserTalk	John & Norah Arnold	46
Apple II Product News		7	Network News		50
Alogol 68	Dave Miller	8	NFL Football Pictures	MacLibrary	54
Time Out Update	Keith Rookledge	14	Two new Macs.		55
ProSel Update	Dave Ward	16	Crystal Paint	Geoff Wood	56
Z-Basic Review	Andreas Wennborg	17	Ancient Art of War	Ceri Fisher	60
Megaboard Review	Andreas Wennborg	18	News from the States		61
No-Slot Clock Review	Andreas Wennborg	18	QuickDex		
PC Transporter	Geoff Wood	21	and MacList	Geoff Wood	62
The Nibbler's Corner		23	Double Helix II	Bill Pearce	64
Vapour Condenses?	Dave Ward	24	Crystal Quest	Ceri & Daniel Fisher	68
/PROCMD	Peter Davies	30	HyperCard Info	Power User Tips	70
Apple II Product News		32	Press Releases		74
The GS Juke Box	John Kishimoto	33	MacLibrary	Norah Arnold	76
The Boffin Answers		34	Members' Small Ads.		80
Lolly Sticks			Advertisers Index		80
and 'Lastic Bands	Jim Harle	37			

Important Contact Points

There are a number of ways to contact Apple2000.

Force users who have a query about the service can contact the administrator, John Lee, directly for help and advice. Call him on the number opposite or send a message to his box on the Force.

If you wish to order goods or services from Apple2000, call Irene on 0751 9228 4142 or (during office hours) call Alison on 07332 740415. Both have Answerphones, in case they're not around. Alternatively you can write to the PO Box or, if you use comms, you can leave orders on TABBS addressed to the SYSOP.

If you are experiencing problems

with Apple hardware or software Dave Ward runs the Hotline and will get you out of the mire.

We are very interested in the activities of local user groups, and if you have any information which you would like publicised John Lee would like to hear from you.

Moans and Groans - We don't get many of these, but Mick Knapp has broad shoulders (and stomach, and thighs...) so send these to him via the PO Box.

A little praise for a few of our authors wouldn't go amiss. Send all comments via the PO box, especially suggestions about what you would like to see in **your** magazine.

The Force

John Lee
0751 9228 4142

Administration

Irene Flaxman
0751 9228 4142

Adverts / Admin.

Alison Davies
07332 740415

Hotline

Dave Ward
0751 9228 4142
Mon-Fri 1900-2100

TABBS

Ewen Wannop - SYSOP
07332 740415

Local Groups

John Lee
0751 9228 4142

Editorial

Apple2000 comes face to face with its members at the Mac User Show

It is entirely possible that you are reading this stood in the Islington Business Centre in London amongst a huge crowd of ardent Macintosh fans.

The reason for this is that the October issue of Apple2000 magazine is the one that we will be taking with us to our stand at the MacUser Show, the premier event for all UK Macintosh Users. We'll be there on all three days, from the 8th to the 10th of November, so even if you are mainly interested in the Apple// range do come along and give us a bit of support.

We will be offering advice and assistance, and if you want to put

some faces to the names it is an ideal opportunity to meet the committee members. All the big names from the Apple dealer network will be there as well as Apple UK, and no doubt there will be some bargain offers.

Unusual Offer

We have had an unusual offer from one of our advertisers, who has sent us a copy of a letter he received from Apple UK and he says that we may publish the letter if we wish.

The legal department of Apple UK have sent a vaguely threatening letter to a number of unofficial Apple dealers, some of

whom import Apple goods directly rather than through Apple UK, and I wondered if Apple2000 members would like to view some of this behind the scenes activity. The letter is possibly rather too long to print in full, but if any of you are interested then we'll print a shrunk down version of the letter and ask Apple to comment on why they sent it out.

The letter is, of course, about that old bone of contention, the price of Apple equipment in the UK.

Apple are anxious to maintain a price structure which guarantees high margins for themselves and their dealers, and they feel that the end customer will obtain a better service in the long term.

On the other hand, some end users feel that the present high prices (and there are rumours of Apple's prices rising by over 15% in the near future) are just a variation of the vice called greed.

Please let us know what you think, and if any of you want to see the letter then we'll publish it and also Apple's comments.

It will shortly be time to make up our Christmas Shopping lists, our next issue will be packed with games reviews! **Mick Knapp** 🍏

Apple2000 brings you two exclusive systems that will give you all you ever should need in modern communications and messaging. National and International messages, Telex, Software Downloading, Contacts, Problem Solving, Special Interest Groups, Teleshopping, Telecom Gold and a host of features tailored for Apple2000 members.

Ring TABBS on (0225) 743797 at any speed through V21 to V22bis 8N1.

TABBS is available 24 hours a day

Ring John Lee on (0373) 848611 for details of The FORCE.

Annual subscription rates are £25.00 for UK residents, £30.00 for E.E.C. residents and £35.00 for other overseas members.

Apple2000™ is a trading name of BASUG Ltd, a non-profit making independent company limited by guarantee.

The contents of this journal are copyright of BASUG Ltd and/or the respective authors. Permission is granted for non-commercial reproduction providing the author and source are properly credited and a copy of the relevant journal is sent. The opinions and views expressed are those of the various contributors, and are not necessarily supported by BASUG Ltd.

This journal is published bi-monthly by BASUG Ltd as a benefit of membership in February, April, June, August, October and December. The copy date is the 5th day of the month preceding publication. Advertising rates are available on request.

Apple™ and the Apple logo are trademarks of Apple Computer Inc. Macintosh™ is a trademark of Macintosh Laboratory Inc and used with the express permission of the owner. Telecom Gold™ is a trademark of British Telecom plc. The FORCE™ and Apple2000™ are trademarks of BASUG Ltd.

The Editorial team is:

Apple II

Ewen Wannop
Mick Knapp

Macintosh

Norah Arnold
Irene Flaxman

Many thanks to all those who work behind the scenes and who receive no personal credit. These people are the stalwarts of Apple2000.

Additional thanks to Walter Lewis of Old Roan Press (051-227-4818) for our printing service, and to Ian Sharp of Sharp Studios (051-227-2788) for our cover design. (Graphics for the cover design supplied by Apple Computer UK Ltd, Adobe Systems Inc.)

Apple2000 are Founder Members and Wholehearted Supporters of the
Apple User Group Council

Delivery Problems

A Description of how the Apple2000 magazine arrives at your door

by Mick Knapp

The magazine is edited as a team effort. There are four people involved in this team, with numerous helpers doing ancillary activities. The major problem with this team effort is that we are located all around the country. Ewen Wannop and myself live about five miles apart in rural Wiltshire, Irene Flaxman lives in Liverpool and Norah Arnold lives in Luton. All of us have full time jobs, so making sure that we have enough of the right material for the magazine, laid out for the camera ready copy which we provide our printer, is a potential nightmare. So how is this done?

Decision Time

The starting point of the decision making process about the when/what/where of the magazine is at the committee meetings which are held every six weeks or so. The magazine sub-committee forms a sort of American football style huddle and sets itself deadlines for such activities as getting in all the advertising material, deciding which pages should have colour, getting in the promised articles, getting the copy to the printer etc. All of these deadlines are based on an estimated delivery date, and although things can slip we normally attempt to post in the first week of the month.

So that the magazine has a good blend of articles to interest both the Apple// users and the Macintosh users, Ewen and I try to concentrate on putting together material pertinent to one group whilst Irene and Norah concentrate on the other. I'll leave it up to your intuition to guess who does which, but a quick scan through the magazine points clearly to our areas of interest.

Variety of Material

We try to ensure that the majority of material is generated by persons other than committee

members, otherwise the magazine has the potential to become a mere forum for committee views. So we have contributions from people like Steve Gold and articles written by members from all walks of life about the software and hardware that they are particularly interested in.

At the same time Alison Davies, our sterling administrator, in addition to despatching all the goodies that you order from us, finds the time to chase up our potential advertisers. The advertising in the magazine is charged for on a space-used basis, and it is a valuable source of revenue for the group. Alison makes sure that all the people who have ordered advertising send their copy to us in good time (otherwise you'd see lots of blank pages scattered throughout the magazine).

The focal point for all the material, both advertising and articles, is the Liverpool PO Box. Irene, with the help of her husband Dave, ensures that the mail is collected from the PO Box on at least a daily basis, and then she distributes this to the relevant parties. She keeps the advertising copy as she will pass this on to the printer at a later stage, but the articles and letters are posted off to Ewen, Norah and myself.

If the articles are not accompanied by either an Apple// or Macintosh text file, it is a nightmare!! That is why we requested help from typists recently, and thanks to all concerned (so many typists responded that we do not have enough "work" for all of you, but we will be getting around to you all). Fortunately most of the articles are in text form already, so that leaves us some time to write a little piece like this one ourselves, and the rest of our spare time is devoted to laying out the text onto the pages.

The Layout

Sometimes this is very easy and sometimes this is extremely difficult. Generally, letters and articles can be laid out fairly quickly using a standard format devised by Norah earlier in the year.

TABBS or Snail Mail

We all get to the stage that we are happy with the layout of the pages that we are responsible for, normally about 30 seconds before the copy date, and then we have to get all the pages to the printer. We use both snail-mail and electronic mail for this, but we feel that we will move more towards electronic mail now, not only because of the vagaries of the postal service (you wouldn't catch me going on strike for less money) but also because all four of us have obtained high speed modems which makes downloading a magazine practical.

To do this the Pagemaker file is saved as a new document to save space (that's a tip from Ewen), and then it is compacted and loaded onto our TABBS bulletin board. Irene then downloads it, unpacks the file and prints off the pages. She then has about a weeks work to do, correcting all the errors that the rest of us have made, putting in headers and contents lists, before she prints off a final copy on high quality paper. This is passed to the printer who generally delivers the bound magazines back to Irene about a week later.

While this has been going on Keith Chamberlain, the chap who manages the membership database (he also finds time to complete the Force bills) prints off an up-to-date set of labels. These are sent to Irene, and she and her husband sit by the fireside solving all the problems of the world while they tediously pack the magazines and label the envelopes. Fortunately she has a super agreement with the GPO so we don't have to stick stamps on the envelopes; she hands them over en bloc and a few days later your magazine pops through your letterbox, and we have a meeting to discuss the date of the next magazine.....

Mick Knapp



Dealer Profile

Decimal Business Machines, Bristol.

Throughout coming issues of Apple2000 magazine we will be reviewing the profiles of a number of Apple dealers. The idea of this is to give you, the customer, a chance to find out a little about the history and specialisations of your local Apple organisation. This is the face that Apple presents itself to the public, and this month the platform is given over to Decimal Business Systems of Bristol, who not only fully support the complete range of Apple hardware and peripherals, they also host the Bristol Apple Users and Dabblers (BAUD) User group meetings.

DECIMAL BUSINESS MACHINES LTD

COMPANY PROFILE

Decimal Business Machines Ltd is a general Office Equipment dealership who have been established for almost 30 years. Based in Central Bristol, with a Main Showroom and a separate administrative block, and a Branch in Tiverton, the Company is a Distributor for most of the major names in electronic office equipment and business systems spread over a customer base ranging from the small "one man" operation, to major national and multi-national organisations, Government Departments and Local Authorities.

The Organisation

With a staff of around 80 people, of whom over 20 are employed in the Service and Technical Support function, the Company operates in seven clearly defined Divisions - Typewriters and Word

Processing, Photocopiers and Facsimile, Supplies, Dictation and Audio, Calculators, Service, and Systems and has seen steady growth over the years to its present position as one of the major suppliers in the City, and West Country.

Not Just Apple!

Systems Division, which is solely responsible for all Hardware and Software sales, has a staff of five, together with two engineers as full time cover for Technical Support, and has the Apple Dealership, with one other covering IBM compatible machines. As one of the first three Apple Dealerships in the West Country, there is a long established and comprehensive customer base of existing Apple users, who have remained loyal to both Apple and DBM since Apple first came to the UK, and with the national growth in the PC market over the past three years, the Division has increased its turnover and profitability at a dramatic rate.

Specialised Services

Whilst catering for the all-round demands placed upon any system supplier by customers requiring both software and hardware, the Division also specialises in four specific markets - CAD, Customised Software, Desk Top Publishing and Accounting Systems, and some interesting projects have been undertaken in all areas, particularly Customised Software, where programs have been written for such diverse applications as running a County Agricultural Show including such reporting functions as milk yields on animals exhibited, to computing

residual weight values for steel plate after processing for a major international Steel Stockholder !!!

The Contacts

Under the direction of Brian Bell, who runs the Division in addition to dealing with Accounting applications, other personnel are Steve Hodges who writes and markets Customised software, Ken Bell who deals with CAD and DTP, Mark Hooper who heads the Hardware and Software support function as well as becoming involved with DTP, and the youngest member Gary Bidwell, who is learning the support function to enable Mark to assist in other areas. All of them are dedicated Apple users with their own Macintosh SE HD20 on their desks, as well as having them linked into DBM's own in-house Macintosh network with a further 280mb at their disposal to play with !!!

Needless to say, any of them will be pleased to assist Apple users in any way they can, and will welcome approaches on any application that may be required, at:-

Decimal Business Machines
Limited
Decimal House
Thomas Lane
Bristol
Tel: 0272 - 294591

Decimal Business Machines Ltd. now houses the local user group BAUD (Bristol Apple Users and Dabblers). It is thanks to the dedication and interest from the staff at DBM that the group flourishes with a home of this kind.

BAUD is as old as Apple2000 itself, and has had various 'hosts' over its ten years existence. Originally born in the days when the Apple II+ was the latest thing in computers, and through a need for educational and business users to get together and share experiences, BAUD now has members who cover the entire range of Apple machines from DTP to education.

Contact Colin Rogers (01454) 411407/11.
Mick Knapp

Letter Box

The avalanche continues with this month's Apple Postbag from Members

87 rue La Fontaine
75005 PARIS
France

Dear Editor,

I've just received the August issue of Apple2000 and find it even more interesting than the last one. As a new reader left high and dry by both the French 'Golden' and English 'Apple User' I am very satisfied.

Re 'Apple User', Database did not even give me an option (in fact the insert of 'The Nibbler's Corner' p.28, was the first I's heard of this possibility). I did, however, receive a magazine called 'MacUser' sent by Dennis Publishing as a substitute. Being the owner of an Apple //e and an Apple //c I thought this most inappropriate and have asked for my repayment of my 'Apple User' subscription.

I am increasingly worried by changes in the computer world, both in hardware and software. Take the Apple firm itself, no sooner had I bought my Apple //e in 1983 than the enhanced model was announced, followed a little later by great publicity for the mac and now the GS. I have a few friends who manage to follow the trend and update but this is not a general move. In software there is the same problem. 'Multiscribe' has been the subject of several articles in American and European magazines and, after trying it out, I decided to adopt it for short articles and newsletters (the advantage over 'Newsroom' being that it can be made to print French accents). Just as I'd decided to invest in the associated utilities 'Open Apple' August 1988 Vol.4 No 7 informs me that Claris Corporation has purchased all the outstanding stock of StyleWare Inc. and has not decided on the future of the //e-//c products. This article also referred to the disappearance of 'AppleWriter'.

I know that the Apple people think that we //e-//c users are all kids playing games. Is there no way to convince them that this is not so? Right here in Paris (where it is becoming extremely difficult to find Apple II products), I know of a group of ac-

countants, an important research unit in a hospital, doctors of all kinds (general practitioners and specialists), a man making up an Italian dictionary, etc... all happily using Apple II's of all versions. Most of these people are over 40 and several over 60.

My own //e (nickname 'Compote' or stewed Apple) was chosen way back in 1983 because I needed a computer capable of handling a data base of several thousand entries with a French/American keyboard and possibilities of extensions. After trying out PFS file (useful in some cases but slow to consult), I bought QuickFile which, in addition to its speed and capacities, interfaces with AppleWriter. The original use was to enter data and produce text for a 40,000 word thesis obtained last year. As you can imagine, when doing such work, one does not 'switch horses' in the middle. Therefore there was no question of updating to the enhanced version during the dates this was offered at a reduced price, nor of later exchanging for the GS model. I could not run the risk of problems with the work already on disks.

My AppleWriter program was the DOS version. Several people suggested I switch to AppleWorks in ProDOS thus having the possibility of incorporating all the QuickFile data and expanding the files. During the tryout the problems were many: I needed to learn a new operating system; some of the converted files showed a loss of data (DOS-ProDOS), the print files were the wrong way round, etc. but, above all, the American AppleWorks had no accents and the French AppleWorks (with accents) did not recognise an added Flipper 1 meg card. Neither program gave me the layout I needed with footnotes of various kinds.

After reading an article in 'A+' on word processing programs I decided to try Gutenberg JR which I found easy and amusing to use. Expecting even better results I then tried Gutenberg SR but found the manual ex-

tremely difficult to follow. The Gutenberg people were very friendly and even setup the layout for my thesis but, after running into problems with superscripts, they suggested I switch to their ProDOS version. I again lost data doing so.

My final thesis was therefore produced mainly with AppleWriter and QuickFile (thus speeding up work since I know both programs extremely well) but using a combination of both Gutenberg programs (DOS version) to produce the title page, synopsis and a table of contents using roman numbering for the pages (layout stipulated by the university authorities). There was no problem for accents, even the '^' which needs a backspace instruction.

The main utility program tried is 'Sensible Speller' which, not only counts words much quicker than the AppleWriter utility (WPL) but also helped me keep out unwanted French words (I think in that language) and correct typing errors. (I've also experimented with 'Sensible Grammar' but only have the ProDOS version).

AppleWriter and QuickFile also been used to produce a library list of 700 books, magazines and manuscripts in three versions: numerical, alphabetical and by subject. The cover page this year will be produced with 'Printshop'.

In my spare moments I like Printshop, Newsroom and similar programs but do not know how to teach them to include accents.

I'd be very interested to hear from other //e users who word process in a language other than English.

Margaret Audin

□ Everywhere I look, whether it be Europe or the United States, the common experience is that the Apple II is used for serious business or research purposes. I myself find that any tele-communications work is much easier on a II than on a Mac, mainly because an 80 column screen is faster and better for data than a Mac screen or even a IIGS screen. Word processing of large documents is also easier on the II. There is no need of a Macintosh or other machine if the II will do what you want of it. The IIGS is the path that Apple would like us Apple II owners to upgrade to. However they persist in thinking of this as a 'games' machine, and certainly in the UK do not market it with any seriousness.

You mention another problem, that of machine and software upgrades. There is really no answer to this one. Inevitably as time goes on, the designers of both will improve and add features to an already successful product. They can launch a whole new machine or program, or take

the simpler route of providing an upgrade. Time and money are spent in developing these new products, so a charge must be made of some kind. Without this development, where would we be? No IIGs, or even no Macintosh ...

Ewen Wannop



34 Wiggles Road
London
W5 5SB

Dear Friends,

The recent issues of Apple2000 have given this reader great feelings that even with the huge energies of Jim Panks gone from the Editorial chair (but not forgotten), each Apple2000 continues in good form.

August letters from David Newman & John Marks mention use of the Apple II in business & 'professional work'. This bears out my own experience that the machines especially the GS are used much more for this than 'home & play' as Apple in the US & UK seem to feel. I saw a recent interview with one of Apple US's senior execs who was convinced that in the UK the current IIs are for the home market! Who could afford to have the GS used only for this?

Dave Ward wrote of the Open Apple monthly newsletter, and I wonder if I might reiterate one point? The Open Apple editor Tom Weishaar feels that the overseas subscriber is so important that he has the same subscription for us as he sets for the US client, as well as the free trial subscription. I presume he feels it pays dividends, and having had Open Apple for a couple of years I have seen where an AppleWorks bug had been reported in the US Midwest, been confirmed around the US and finally solved in Australia. I find the bound annual volumes more useful for travel and dipping into so I will buy the complete set (Any one want to buy loose issues for the last two years?). Incidentally some news from the Open Apple was printed in the mag, and I presume a deal was struck to use such material, if so what are the terms? The best use of such material would be of bugs, fixes and some news but not purely rumours and news, we can produce our own rumours, can't we?

Dave mentioned a bug in the August issue I had found in my own work early this year, whereby when using AppleWorks V2 to work and save a database set up under V 1.3 or earlier one can't recover it after saving. No fix has come up anywhere I can see to recover the file although the AppleCrackers bulletin board team offered to try for me & I have been too idle to follow through yet. There is a possible improvement for this bug in the new version of AppleWorks, see below. I will try the route that Dave

recommends however although Dave says in his letter 'one should back up regularly' its such a blinking chore. Oh for an automatic incremental back up method!

The August edition of the AppleWorks Forum (US AppleWorks Users group monthly publication) features is a new Version 2.1 of AppleWorks from Claris US. Is there any word from Claris here on upgrades? The changes reported are:

*Support for up to 8 megs on the GS
Increase from 67 files to 138 per sub-directory
Spreadsheet; recalculation only in cells that have been changed
Bug fixes for some accessories, data files full (possibly my problem), printer control codes, page numbers to 256
Pathnames to 64 characters now
Use of ProDOS 8, version 1.5, that certainly sees the Apple GS clock*

Claris (0635 49138) via their distributor Frontline Distributors (0256 463344) Lorraine French told me they had Version 2.01 since April! However this is not the improved version 2.1 as in the US, I feel its merely 2 under the Claris label I think. We will have to find out from our US friends.

Claris has been busy in other directions too, they have bought up the Styleware company that publishes amongst other things Multiscribe and the new GS Works. Lorraine French at Frontline says she is sending a press release about this soon to cover the British launch, perhaps Apple2000 can get a copy for review from whom-ever.

With the demise of Apple User there are a few outlets for articles on the Apple computers, & it is encouraging to see the US Computer Shopper have a British version which although stuffed full of cheap and not so cheap IBM clones has an Apple GS section by John Molloy. He even mentions Apple2000. Ewen and the Bulletin Board. What I found puzzling is that the front index of the August edition showed 3 GS articles I found only one! Still thats a beginning.

You may be interested to know that I went to see Zip Chip people in Los Angeles in May while on a business trip there, and was given a chip to bring back. I tried to get it going with the good folks at Bidmuthin but without success, the chip went back and has not been replaced. While waiting at the Zip chip office I saw a //e and //c with chip working away, and was shown how easy it was to switch from one speed to the another. Bill McCaslin the president of the company explained that they had great production difficulties, in the printing of the chip circuits particularly, and at that time were just beginning to send out the chips to reviewers and others in a

bid to counter the rumours & the self inflicted 'vapourware' atmosphere around the Zip Chip.

Lastly is there a new ProSel version out and if so what number and would some one review the version of Copy II+ 8.3?

Huw Price

□ With letters like these, we hardly need articles! Thanks a million Huw.

Please support Open Apple, we carry their advertisements as part of a deal to let us use parts of their magazine. We now have a team of typists lined up, so we should see more from OA in due course. It is quite unique as a publication, it has no advertisements itself, so is unbiased in its views. I take your points about what to include.

I do not have the full details about the AppleWorks upgrade yet, but gather it is in the region of £50!

You will see that the Zip chip is here in England. Dave Ward has done a magnificent job in reviewing it. It was plugged into my //e and worked a treat. I want one ...

ProSel is now at version 3.8, and you will see reference to that as well by Dave. Copy II+ 8.3 is exactly the same as 8.2 except for the Parameter files. These are greatly increased for the 3.5 disc Bit copying. We have not done a review of this program, any volunteers? I am sure John Gurr at MGA would oblige with a copy ...

Ewen Wannop



34 Wiggles Road
London
W5 5SB

Dear Apple2000,

Using AppleWorks as the mainstay of my business, I have been happily expanding the capabilities of this program with the increasing range of add-ons that have come onto the market during the last two years, starting with a //e and now with the IIGs as well.

The first addition was 1 meg AE RAM-card, which coupled with Autoworks made a combination that was a delight to use. With the expansion of the business as a good excuse, the next purchases were a GS, plus a 1.5 meg AE GS Ram card with two 3.5" drives - one for each machine.

The latest purchase was Beagle Brothers Desk Tools - The Calendar has proved particularly useful, in spite of the nasty habit of the Calendar.data file of informing you that no changes have been made and so there is no need to save it, when you've added ten vital appointments or tasks & thrown out the notes that prompted them!

HOWEVER AppleWorks is no longer easy to use. The new drives

with their comparatively vast 800K, soon put up a message with the stern and chilling announcement "Cannot write to this drive". Our friendly, helpful (and idiot-worn) dealer rescued us from that one - we just weren't used to getting so many files onto a disk, so after 50 it seized up. The answer was to start exploring the wonderful world of ProDOS directories (of course).

The acquisition of Desk Tools has brought us into the newest pit-fall. My wonderful macros don't work - or at least the best ones certainly don't, nor can I make new ones, and I'm back to doing things the hard way, despite Beagle Brothers providing and update on Autoworks.

Beagle Brothers Technical support tell me that the combination of GS RAM, Autoworks and DeskTools is beyond the capacity of the GS, and Autoworks becomes Auto-partly-works.

Eyeing with anticipatory gusto the new super accessories in the Beagle Brothers latest range of AppleWorks enhancements I need to know - will they all work together. OR, what combinations can I utilities? AND, do I now have to buy a Super Macros to replace Autoworks?

Is this GS-indigestion the cause of the Data Conversion utility working on big files? It accepts and converts the first clip-board load, but stalls after that. And the Case Converter can't manage to Capitalise Initial Letters.

Finally, is there an AppleWorks Business Users Group whom I can share these heart-aches (after all, a trouble shared is a trouble doubled) plus any good ideas, and put the Apples and AppleWorks to even better use?

I would very much appreciate any light that you might be able to throw on these dark patches.

Michael Corgan

□ There are so many accessories for AppleWorks, it must be impossible for any one person to know them all. But collectively the members must be able to put this knowledge together.

As the best selling business package outside of Lotus 1-2-3, AppleWorks deserves its rightful place in the Apple lineup. The gauntlet is thrown down by Michael. We at Apple2000 can co-ordinate your efforts through the magazine and our other services. I would suggest that those interested write to Michael, and try and organise yourselves together.

I was interested to see that Michael had the old problem of filling the main directory of a ProDOS disk. In fact ProDOS can see any size of directory and expands its size as needed (the sub-directories show this). I have never seen ProDOS do this to the main directory though. There is noth-

ing to stop it doing so... why did Apple not make ProDOS work as it was intended?

Ewen Wannop

90 Plasmore Road
Aston Green
Birmingham
B27 6LN

Dear Sirs,

I write to tell you of my experiences to date and in the hope that you will print this letter, stir up some interest etc.

In 1983 I bought a Tandy model 100 as I could not afford an Apple, although this was what I thought I needed. I quickly decided that the Tandy was too limited for my uses and was avidly scanning the pages of Exchange and Mart looking for bargains in used equipment. It was there I spotted an Apple Europlus with customised keyboard two half height drives and CP/M software including WordStar and Sage accounts.

I studied hard and worked well with this machine also acquiring a copy of DBASE-II, running under CP/M. After some eighteen months and much experimentation, (using three drives etc.) I bought a Cirtech Plus ram. This made quite a difference to the Apple II+ and I was quite pleased.

However, one day the Apple would not start up from cold and after much telephoning asking dealers etc., I discovered the power supply was on the blink. I asked around for the cost of a new heavy duty supply and was quoted prices from #80.00 plus VAT to #34.00. After much deliberation and a kind friend I was able to sell my II+ and purchase an Apple IIGs, complete with Cirtech CP/M plus.

I was delighted with this machine (and still am), all my current CP/M software works fine and I have even installed Sage accounts to run of my expanded 1mb PlusRam and the single 800k floppy disc. I have an Apple modem and a CP/M comms programme but this requires the use of a serial card, which I resent having to fit, seeing as my machine has a dedicated comms port. I have asked for help in reprogramming my comms package on many BBS and in Apple User but to no avail.

What I would like is for any CP/M user to contact me and we could swap details, info and generally help each other. (Ed: we can co-ordinate your efforts through Apple2000 if needed)

I have recently purchased the Cirtech CP/M programmers guide and am going to have a go myself.

To complete my suite of programs I would like a program called SUPER-CALC that runs under CP/M and will work on my APPLE.

Dan Finnimore

Apple II Product News

From Cirtech in Scotland come some new products and additions to their range.

The Champion Plus is a versatile interface card for any of the Apple II range. In one card it combines a serial (RS232) interface a parallel (Centronics) interface and is 100% compatible with the Apple Super Serial card and Parallel Printer card with the flick of a switch.

Basic Champion card Serial only #68.00

Dual Champion Serial and parallel #78.00

Interface cables each #10.00

The popular PlusRAM 1 meg card has now been renamed PlusRAM-1, as it now has a big brother PlusRAM-16 that can be expanded to 16 meg with the same number of chips! Think of it, almost as much as a hard disc drive on one standard size Apple card!

PlusRAM-1 256k-1 meg with 256k #99.00

PlusRAM-16 1-16 meg with 1 meg #229.00

The PlusDisk battery back up Ram board has now also got a big brother PlusDisk-SC, only this one lives outside the computer in a plastic box with a SCSI interface. For the first time we have a Cirtech product that our Macintosh brethren can use! For the present sizes start at 1 meg through 4 meg, but this limit will no doubt rise as chip prices tumble. Although an expensive way of providing expansion RAM disk facilities, the speed of access is very much faster than a normal hard drive.

The RAM is fully battery backed up, and memory is guaranteed to hold for 2 months. To complement the PlusDisk-SC, Cirtech have also introduced a SCSI card for the II series.

PlusDisk-SC 1 meg #348.00

PlusDisk-SC 2 meg #579.00

PlusDisk-SC 4 meg #1090.00

SCSI interface card #54.00

Cirtech (UK) Ltd.
Currie Road Industrial Estate
Galashiels, Selkirkshire
Scotland, TD1 2BP
(0896) 57790

Algol-68

Dave Miller continues with his series of articles on Algol

ALGOL-68

In this instalment I shall complete my discussion on ALGOL by covering ALGOL-68 (if you have not read the last two instalments covering ALGOL's background and ALGOL-60 then I suggest that you read them before reading on).

In the years directly after the first ALGOL Report was issued in 1960, several revisions were suggested in an attempt to better the language. The three most important were:

"Some proposals for improving the efficiency of ALGOL-60" (1961, C Strachey & M V Wilkes)

"Revised Report on the Algorithmic Language ALGOL-60" (1963, P Naur)

"Revised Report on the Algorithmic Language ALGOL-68" (1976, A Wijngaarden et al)

The latter was the result of a near-complete reformulation of the ALGOL language which resulted in ALGOL-68. ALGOL-68, although based upon ALGOL-60, embodies such drastic changes that it can not really be considered the same language.

The key note in ALGOL-68's design is "orthogonality" which means that the language revolves around a few fundamental principles which apply uniformly to the whole language. This means that syntactically, (i.e. in terms of the actual structure of the language), ALGOL-68 is simple: there are no exceptions to the basic rules governing the language. Of course, this does not mean that the language is simple. In fact, ALGOL-68 is rather complicated, in a uniform sort of way (!).

ALGOL-68 is reckoned to be one of the most powerful general purpose computer languages available offering many features, allowing structured programming and producing efficient machine code.

The sheer scale of ALGOL-68 means that, until recently, full implementations of the language were relatively rare. Those which did exist were notorious for hogging computer resources, especially during compilation.

Rather than listing out the features of ALGOL-68 (a near-impossible task in less than a few hundred pages!) I shall limit myself to discussing the main areas in which ALGOL-68 differs from ALGOL-60. To emphasise the difference, code fragments in ALGOL-60 will be written with the keywords enclosed in primes, (as adopted in the previous articles), and ALGOL-68 code will be written with the keywords

emboldened (the standard practice when including ALGOL-68 code in reports and publications).

Language structure

The general language structure of ALGOL-60 is retained in ALGOL-68. There are two obvious changes:

□ Keywords

ALGOL-68 has many more keywords than ALGOL-60. Some keywords are common to both languages while others have been changed when included in ALGOL-68. Actual ALGOL code, when entered into the computer, uses the 'keywords-in-primes' method.

□ Compound statements

These have been effectively removed from the language. It is still legal to place one in a program but it performs no function. You will remember that ALGOL-60 uses compound statements to force IF and FOR statements to apply to a series of statements rather than to just one:

```
'begin'  
  'integer''array' a [1: 10], b [1: 10];  
  'integer'      index;  
  'for' index := 1 'step' 1 'until' 10 'do'  
    a [index] := 0;  
    b [index] := 0;  
  'comment' other statements  
'end'
```

In the above FOR statement, only the assignment to "a" is performed repeatedly. To force the FOR statement to apply to both assignments it has to be rewritten thus:

```
'begin'  
  'integer''array' a [1: 10], b [1: 10];  
  'integer'      index;  
  'for' index := 1 'step' 1 'until' 10 'do'  
    'begin'  
      a [index] := 0;  
      b [index] := 0  
    'end';  
  'comment' other statements  
'end'
```

What happens, though, if there be a mistake involving the semicolon? The use of the semicolon sometimes causes confusion, since in some situations the semicolon is not needed (e.g. when a statement is followed by 'end'). Some people have the habit of appending unnecessary semicolons to the end of statements in the hope that too many are better than too few; extra semicolons are usually ignored by the compiler. It takes one slip and a misplaced semicolon can completely change the operation of the above FOR statement:

```
'begin'  
  'integer''array' a [1: 10], b [1: 10];  
  'integer'      index;  
  'for' index := 1 'step' 1 'until' 10 'do';
```

Your Apple Dealer for all

Please add VAT
to all prices

APPLIED ENGINEERING PRODUCTS

Now available at greatly reduced prices!

For Apple II+, IIe, IIgs

PC Transporter with 384K	£249.00
PC Transporter with 640K	329.00
Kit for Apple IIgs	29.00
Kit for Apple IIe	29.00
TransDrive 360K Single-Drive	149.00
TransDrive 360K Dual-Drive	199.00
360K additional Half-height TransDrive	79.00
IBM-style Keyboard including Cable	79.00
Digital RGB adaptor	15.00
ColorSwitch Analog RGB adaptor	25.00
8087-2 Math Co-processor Chip (PC Transporter)	149.00
RamFactor 256K	149.00
TimeMaster HO	69.00
Phasor	99.00
A/D + D/A Card	109.00
16 Channel, 12 Bit A/D	159.00
I/O 32 Card	49.00
High Output Power Supply (Not IIgs)	69.00

For Apple IIe

RamWorks III 256K	139.00
RamWorks III 512K	219.00
RamWorks III 1Meg	359.00
RamWorks III 3Meg	999.00
TransWarp Accelerator Card	129.00

For Apple IIc

Z-RAM Ultra III 256K	219.00
Z-RAM Ultra III 512K	299.00
Z-RAM Ultra III 1Meg	459.00
Z-RAM Ultra II 256K	169.00
Z-RAM Ultra II 512K	249.00
Z-RAM Ultra II 1Meg	429.00
Z-RAM Ultra I 256K	139.00
Z-RAM Ultra I 512K	219.00

HOLDENS COMPUTER SERVICES

191-195 Marsh Lane, Preston PR1 8NL

Telephone (0772) 561321 or 52686

```
'begin'
  a [index] := 0;
  b [index] := 0
'end';
'comment' other statements
'end'
```

Here a semicolon has been appended after the 'do'. This is perfectly legal and terminates the FOR statement thus causing the computer to loop around the FOR statement doing nothing at all. The assignments to "a" and "b" are performed once after the loop has exited inside what is now a superfluous compound statement. The chances are that the program will crash because the value of "index" will either be 11 or some undefined number when the loop is exited thus causing an "array subscript overflow error" when the arrays are assigned.

ALGOL-68 removes any chance of this happening by demanding that constructs have mandatory predefined beginning and end keywords:

```
begin
  [1: 10] int a, b;
  int      index;
  for index to 10
  do
    a [index] := 0;
    b [index] := 0
  od;
  comment other statements comment
end
```

The beginning marker for the above FOR statement is **do** and the ending marker is **od**.

This removes such ambiguities from the language as the following, where it is difficult to know which 'if' an 'else' applies to:

```
'if' c1 'then' 'if' c2 'then' s1 'else' s2
```

Is "s2" performed when "c1" is false or when "c2" is false? In fact ALGOL-60 states that the 'else' applies to the lastmost 'if' but there is nothing in the code which indicates this. ALGOL-68, though, leaves nothing to doubt:

```
if c1 then if c2 then s1 else s2 fi fi
|           |                               | |
|           +-----+                       | |
+-----+-----+-----+-----+-----+-----+
```

The end of each IF statement is marked by the keyword **fi**. The above IF statement indicates that statement "s2" is performed when condition "c2" is false since **else** is inside the IF statement governed by condition "c2".

Data structures

ALGOL-60 offers only three types of variable: Integer, real and Boolean.

ALGOL-68 supplements these with **char** which holds a character value. Arrays of **char** are used in much the same way as BASIC's strings.

ALGOL-68 also offers arrays, as does ALGOL-60, but with many more facilities. Multidimensional arrays can be sliced into 'columns' and 'rows':

```
begin
  [1: 5, 1: 5] int matrix;
  comment "matrix" is a square array of
    1 to 5 on each side comment
  int index;

  for index to 10
  do
    comment take slices of "matrix" comment
    dosomething (matrix [index,])
  od
end
```

The above passes each of the five columns of "matrix" to procedure "dosomething" in turn. This slicing can be performed on arrays of any dimension (greater than one of course!).

Arrays can also be split:

```
begin
  [1: 11] char text := "hello there";
  comment define character array and
    initialise it comment
  print ((text [1: 5], newline))
end
```

The above isolates the first five elements of the character array "text" and prints them out followed by a carriage return and line feed: "hello" is output.

ALGOL-68 offers STRUCTURES. These allow variables to be grouped together into larger chunks of data which can be manipulated as a whole (see December 1987 article on COBOL for a further discussion on the benefits of record handling).

```
struct ([1: 15] char name, int telephone)
  person
```

The above declaration defines a structure called "person" with two fields: a 15-character string, called "name", and an integer number, called "telephone".

The fields are treated as normal variables are accessed as follows:

```
name of person := "Ivor Notion ";
telephone of person := 1234
```

Referencing "person" accesses all fields of the structure as if they were one data item.

Structures can be applied to new variable types in a similar fashion:

```
mode persrec = struct ([1: 15] char name, int
  telephone);
[1: 20] persrec personinformation;
persrec      somemoreinfo;
```

The above defines "persrec" as a new variable type (or "mode") and then declares "personinformation" as an array of "persrec" elements ranging from 1 to 20. The variable "somemoreinfo" is also declared as being of the type "persrec". The mode "persrec" is regarded by ALGOL-68 in the same way as **int** or **real**.

Program statements

As has been already stated, the compound statement is still legal in ALGOL-68 but performs no function. Blocks are still supported in the same way as in ALGOL-60. Most of the main statements have been modified in their transition to ALGOL-68.

□ IF statements.

IF statements now have not only an optional **else** construct but also have an **elif** construct which is **else** and **if** merged together:

```
if cond1 then
  dosomething
elif cond2 then
  dosomethingelse
else
  doanotherthing
fi
```

The above ALGOL-68 IF statement is equivalent to the following ALGOL-60 IF statement:

```
'if' cond1 'then'
  dosomething
'else' 'if' cond2 'then'
  dosomethingelse
'else'
  doanotherthing
```

ALGOL-68 also allows IF statements to be contracted. The ALGOL-68 IF statement could be written as:

```
(cond1 | domesomething | :cond2
 | dosomethingelse | doanotherthing)
```

This, although totally unambiguous, is rather difficult to understand!

□ FOR statements.

ALGOL-68 has only one type of FOR statement:

```
for index from start by step to stop while
  cond
do
  statements
od
```

This is the full version of the FOR loop. ALGOL-68 allows various parts to be omitted (only **do** and **od** are mandatory). If parts be omitted then they take on default values as indicated below:

```
for index from 1 by 1 to infinity while true
do
  statements
od
```

Thus:

```
for index to 10
do
  comment count from 1 to 10 in unitary
  steps
  comment
do
```

```
while i > 8
do
  comment loop while i > 8 comment
od

do
  comment loop forever comment
od
```

□ CASE statement.

This is a new type of statement not supported by ALGOL-60.

It provides a short-hand notation for the following IF statement:

```
if x = 1 then
  procxis1
elif x = 2 then
  procxis2
elif x = 3 then
  procxis3
elif x = 4 then
  procxis4
else
  procxbig
fi
```

This is equivalent to:

```
case x
  in
    procxis1, procxis2, procxis3, procxis4
  out
    procxbig
esac
```

Like the IF statement, this can be contracted to:

```
(x | procxis1, procxis2, procxis3, procxis4 |
 procxbig)
```

□ Comments.

In ALGOL-68 comments are not regarded as statements and so do not require a semicolon between the end of the comment and the following statement. The keyword **comment** is used to mark both the beginning and the end of the comment; **comment** can be reduced to **co**.

□ Assignments

ALGOL-68 allows some special contracted assignments:

```
n+ := 1   co => n := n + 1 co
n- := 2   co => n := n - 2 co
b* := 3   co => b := b * 3 co
b/ := 4   co => b := b / 4 co
```

Procedure parameters

ALGOL-68 offers value and reference parameters like ALGOL-60 but the method of parameter specification has changed. ALGOL-60 assumes that all parameters be reference unless they be explicitly marked as value by a 'value' statement. ALGOL-68 adopts the reverse: all parameters are assumed to be value unless explicitly marked as reference

by a **ref** attribute:

```
proc add = (int a, int b, ref int result)
void:
comment
    "add" is a procedure which returns
    no value (i.e. it is not a
    function)- "a" and "b" are value
    parameters and "result" is a
    reference parameter
comment
begin
    result := a + b comment return a value in
        "result" comment
end
```

Procedure "add" is called as follows:

```
add (2, 5, sum) comment sum := 2 + 5 comment
```

ALGOL-68 Units

ALGOL-68 is based not upon statements, but upon "units". A unit is an item which may return, or yield, a value: 2, a + b, (23 / 14) * m are all units. In fact any expression is a unit (this includes function calls). Statements are also regarded as units and can yield values (this is hinted at in ALGOL-60 by the conditional expression: a special IF statement which returns a value).

ALGOL-68 allows some very odd-looking constructions:

```
value := (case x
    in
        10, 30, 18, 30, 18
    out
        0
    esac) *
(if limit then
    1
else
    scale
fi)
```

Determining what the above assignment does is left as an exercise for the reader but I will say that when "x" is 1, "limit" is **false** and "scale" is 5, "value" is set to 50 and whenever "x" is greater than 5, "value" is always zero.

I could use ALGOL-68's contracted IF and CASE forms to give the following version of the same assignment:

```
value := (x | 10, 30, 18, 30, 18 | 0) *
    (limit | 1 | scale)
```

This looks even more hairy! An interesting aside is that both the contracted IF and CASE statements look very similar. This is because CASE is really only a special abbreviated form of IF statement.

Since statements are units, CASE and IF statements can be used as values in an expression so long as they yield values.

This philosophy is also applied to procedures ("orthogonality", remember?). Each procedure can

yield a value- these are, of course, functions. In ALGOL-68 all procedures yield values unless expressly indicated otherwise (as in the procedure "add" listed above: "add" is given the type **void** which means that it yields no value at all).

Even assignments can yield values: a := 2 actually yields the value 2 so the following is valid, but rather pointless, ALGOL-68:

```
if ((a := 2) > 3) then
    print ("2 > 3!")
else
    print ("All is OK, 2 < 3")
fi
```

The assignment to "a" yields the value 2 which is compared with the value 3 in the IF statement. Since 2 is never greater than 3 the **else** construct is executed. Note that "a" is assigned the value 2 before the condition is tested.

Observe the following wonder-assignment:

```
x := (y := 16) + 3
```

this is equivalent to:

```
y := 16; x := y + 3
```

In fact everything which is executable can theoretically yield a value and is classified as a unit. Like ALGOL-60 statements, units can comprise of many individual units which may be statements. The overall value yielded by the unit is the value yielded by the last constituent unit.

Thus for the following unit (a procedure which yields an integer value- i.e. an integer function):

```
proc func = int:
comment
    "func" is a parameterless procedure
    which yields an integer value
comment
begin
    int a, b, c;
    a := 2;
    b := 3;
    c := 5
end
```

Procedure "func" yields the value 5 because the last unit inside it (the assignment to "c") yields 5. Thus the following outputs the number 5:

```
print (func)
```

Generally functions return values by specifying the last unit as an expression:

```
proc factorial = (int number): int
comment calculate factorial (recursively)
comment
begin
    if number < 1 then
        0
    elif number = 1 then
```

```

1
else
  number * factorial (number - 1)
fi
end

```

Procedure "factorial" consists of one unit, an IF statement, which yields three possible values, 0 if "number" be less than 1 (error trap), 1 if "number" be 1 and number * factorial (number - 1) for all other values (this is a recursive call to procedure "factorial"). The yielded value is then passed back to the caller as the result of the procedure. I leave it as an exercise for the reader to trace the operation of the "factorial": try "factorial (5)"- the result is 120.

Conclusion

I could go on and on (and on and on...) but, to the cheers of thousands, I think that I have said enough about ALGOL-68 to keep most people happy/confused (delete as appropriate).

I think that everyone will agree that ALGOL-68 is by no means a limited or poor language. Indeed, it is rather too complicated because the number of valid combinations is almost mind boggling. ALGOL-68's orthogonality, whilst mathematically and syntactically very elegant seems rather too free as far as humans are concerned.

Whilst ALGOL-68 is very powerful it still has shortcomings: the most important is that its file handling facilities are rather limited.

ALGOL-68's fans say that its deficiencies are not too important and that its benefits far outweigh any failings. They point to the fact that learned and theoretical computer science publications have code listed in ALGOL-68 as proof of the language's suitability for general purpose scientific applications.

Sceptics, whilst mostly agreeing that ALGOL-68 is very powerful, point out that ALGOL-68 may be ideal for theoretical work but better languages exist for more practical computing. They also point out that reliable, cheap and efficient ALGOL-68 implementations are relatively new, giving other languages time to catch up on the benefits offered by ALGOL-68.

One such language, ironically also a descendent of ALGOL-60, has established itself in an almost unshakable position in the general purpose scientific and business computing field. This is one of the fields that ALGOL-68 was originally designed for. It seems unlikely that ALGOL-68 will ever displace this language from its leading position. What is this language? It is Pascal- the language which was to take ALGOL-like structured programming to the masses and it is the language which I will discuss in the next instalment.

Example program:

The following ALGOL-68 program performs exactly the same task as the ALGOL-60 example program given in the last instalment. It asks the user to type in a series of integer numbers and then writes them out after they have been sorted into ascending numerical order.

```

program numbersort;

comment
  this program reads in a series of
  numbers, sorts them and then
  outputs the sorted numbers

comment

begin
  int number;
  proc readvalues = (ref [] int sortlist)
  void:
  comment
    this procedure reads in the set
    of numbers to be sorted- note
    that the reference parameter
    sortlist is an undimensioned
    array (indicated by "[ ]")

  comment

  begin
    int i;
    comment
      read in all the values
      required- note the use of upb
      - this gives the upper bound
      value of an array (the lower
      bound is given by lwb)

    comment
    for i := to upb sortlist
    do
      print ((newline,
              "Enter value to be sorted:"));
      read (sortlist [i])
    od
  end;

  proc sortvalues = (ref [] int sortlist)
  void:
  comment
    this subroutine performs the
    Bubble sort

  comment
  begin
    bool sorted := false;
    int i, maxnumbers;
    maxnumbers := upb sortlist - 1;
    comment
      loop until the Boolean
      variable "sorted" becomes
      true indicatin that the array
      is sorted

    comment
    while not sorted
    do
      comment assume that all be sorted
      comment
      sorted := true;
      comment examine all the elements of
      the array in turn comment
      for i := to maxnumbers
      do
        comment
          swap adjacent elements
          if the first be greater
          than the second

        comment
        if sortlist [i] > sortlist [i+1]
        then
          begin
            int exchange;
            exchange := a [i];
            a [i] := a [i + 1];

```

```

a [i + 1] := exchange;
comment array is not yet
sorted comment
sorted := false
end
fi
od
od
end;

proc writevalues = ([] int sortlist) void:
comment this procedure writes out the
sorted numbers- note that
"sortlist" is a value parameter
here because its values are
being read and not written
comment
begin
int i, count := 0;
comment clear screen, write heading and
feed two lines comment
print ((newpage,
"The sorted values "are: ",
newline, newline));
comment write out all the values
comment
for i := to upb sortlist
do
comment print 10 values per line
comment
print (sortlist [i]);
if count = 10 then
comment move to next line comment
print (newline);
count := 0
else
comment print four spaces comment
print (" ");
count+ := 1
fi
od
end;

comment this is the main program comment
comment clear the screen comment
print (newpage);
readnumber:
comment ask for the number of values
comment
print
("How many values are to be sorted? ");
read (number);
comment only allow for a number greater
than 1
comment
if number < 1 then
print (("Please type in a number
greater than 1", newline));
goto readnumber
fi;
comment define the array and then read
in the values, sort them
and then output the sorted
values
comment
begin
[1: number] int sortlist;
readvalues (sortlist);
sortvalues (sortlist);
writevalues (sortlist)
end
end

```

DAVE MILLER 

Time Out Update

Keith Rookledge looks at the latest releases from Beagle Brothers

Well, Beagle Bros do it again! They have launched four new applications to enhance Apple Works and I am going to talk about two of these, Thesaurus and Powertools.

- The new Timeout Applications are:
- Thesaurus - exactly what it says it is.*
 - PowerPack - a number of powerful desk top tools*
 - Desktools II - again what it says it is.*
 - Macrotools - a number of new macro facilities.*

I have reviewed the first two, as I found that they have the

most interesting use for my system and the others will be reviewed at a later date.

The new applications come boxed in the usual Beagle Bros way, well documented, together with two vouchers giving you discounts for both OpenApple and NAWUG (National AppleWorks Used Group). I have subscribed to the latter and will keep you updated as to what it offers.

Thesaurus:
A very easy to use manual as we have all come to expect from Beagle Bros. There is a considerable difference in the process of installation compared to

previous TimeOut Applications. The first step involves updating any existing TimeOut utilities facility. This only has to be carried out once with the new applications, however.

You then have to load the application. I had a problem here. I do not yet have a hard disc so I retain the applications on my boot disc - I have a IIGS by the way. I found that with all the other items, I did not have sufficient space to load the Synonyms to disc, so I first had to make space. I removed my comms to a separate disc as I leave AppleWorks to enter comms. This move in fact was later restored, as PowerPack enables you to exit AppleWorks without the usual exit procedure and re-enter without rebooting, but more of this later.

Once I had installed Thesaurus, it's use is simplicity itself. You position the cursor over the word in question and from the applications menu, OpenApple-Escape, one merely selects Thesaurus and your off!

The synonym dictionary is most easily selected from the

same disc, but for those people who use 5.25 drives it can just as easily be accessed from the second drive.

There is not much else that one can say about a thesaurus it works and this one is very rapid and complements QuickSpell.

PowerPack:

I am not sure why this name has been chosen as these applications are desk top resident the same as previous Beagle Bros applications.

There are ten of them in the system :

1. ASCII Values:

Entry into the application is as usual OpenApple-Esc. Selection of the value is achieved simply by use of arrows and the display panel gives not only the ASCII value but also the binary, code, hexadecimal and decimal values. This is obviously of great use to anyone programming and creating Macros as it is very rapidly accessed.

2. AWP to TXT:

Why another such application I ask? Apparently AppleWorks 2.0 adds carriage returns to the ends of lines and is a problem when programming in Basic. I find this application of use when converting from AWP to TXT for transmission to TABBS and the Force.

Again a very easy to use application.

3. Category Search:

AppleWorks searches the data base reasonably rapidly but if using large data bases it can take time. This new facility speeds up the process. I have one database where I have title and initials in front of the name. With the standard OpenApple-F you cannot find the name when viewing the entire file but you can with this facility. Searches are carried out by total field and very rapidly too!

In addition to a simple word or other code search you can search by using a single 'wild-card'. For example B??S will yield all words with 'b' at the beginning 's' at the end and with two letters in the middle. Multiple 'wildcard' searches are carried out using * instead of ? and then the number of letters within the delineated letters is not defined.

In addition the command '@' is a special command which enables you to find only matches that start at the beginning of the word.

Again a useful and powerful tool with a number of applications.

4. Desk Top Sort:

A simple but useful application that enables you to sort the desk top either alphabetically or in any order you require. Of use when you have a full desk to and especially with the new triple desktop.

5. File Library:

For the first time a mild criticism of Beagle Bros. The first instruction reads "Add the Data Base file called 'File Library' to the AppleWorks desktop". Question? Where is it? 

Mclnker™, Automatic Ribbon Re-inker

£42.00



will re-ink your ribbons for less than 5pence and will pay for itself even in one day depending on printer use. Average cartridge can be re-inked 60-100 times. We support over 12000 printers, cartridges, spools, multicolor cartridges. Ask for complete catalog.

Universal Mclnker (cartridge or spool) 68.50
 Multicolor Adaptor (4 color ribbons) 40.00
 Dot matrix Ink (2oz £3.00, 1 pint £18.50 any color)
 IMAGEWRITER SPECIAL £42.00
 >100,000 sold since 1982 (prices include VAT)

MGA SOFTCAT

0233-83571

MGA SoftCat



PEAR TREE
 APPLEDORE, KENT PC
 TN26 2AR ENGLAND

CLOCKPRO

SLOTLESS TIMEKEEPING

Every IBM and Apple II computer needs a clock. The ClockPro keeps perfect time and doesn't waste a valuable slot. It's easy to install and works on any IBM PC, XT, AT, Apple IIe, IIc, II+ and all compatibles and is covered by a full 10 year warranty



£48⁹⁵ incl

MGA SoftCat

TELEPHONE
 0233 83571

COMPUTER DOWN !

- FAST TURNAROUND - NORMALLY 2 DAYS
- 3 MONTH WARRANTY
- COMPETITIVE PRICES ON ALL SERVICES
- TRADE ENQUIRIES WELCOME
- Most Makes of COMPUTER, MONITOR, PRINTER

EXAMPLES ALL INCLUSIVE PRICES

APPLE][+ OR //e Power Supply £32
 APPLE][+ OR //e Motherboard £32
 Apple Interface Card (most makes) £25
 Disk Drive - cleaned & aligned £25

Please ring for other repair prices or send equipment for free estimate
 Quantity Discounts available

SUPERCHARGE YOUR MACINTOSH AVAILABLE NOW !

1MB SIMM'S - EASY TO INSTALL
 Take your Mac+/SE to 2.5 MB or even 4MB
 Take your Mac II to 5MB or even 8MB
 WE WILL NOT BE BEATEN ON PRICE
 TRADE ENQUIRIES WELCOME

NOW IN STOCK

MacPlus Connectors, Serial & AppleTalk
 Price depends on quantity

COMTEC
 ST GEORGES MILL
 3 ST GEORGES STREET
 MACCLESFIELD, CHESHIRE, SK11 6TG
 TEL (0625) 34691

I looked on the TimeOut Disc and sure enough there it is!

Once you have found it then all is clear. From within this file, File Librarian is selected and in a trice you have a list in this Data Base, of all the files on the current disc.

The data base is created in such a way, that all the lines on the file are readily readable in the "all records" section.

This is obviously of great use in storing information on what files are on which disc and in addition if you have a clock, it enables you to check the last update.

6. Help Screens:

This is once more exactly what it says it is. It creates 'Help' screens. There is a good example of a help screen already on the file called Help Sample.

The instructions on how to set up the screen are good and the application will be of great use to people who have an application for it.

It should be noted that once the screen is set up, it does not require PowerTools to run, it is just like any other help screen.

7. Line Sorter:

This application enables you to sort any Word Processor file alphabetically by line. In addition you can use the ASCII values application to see the priority order for the lines that are sorted.

8. Program Selector:

This is one application that is of great use to me, as I get tired of quitting AppleWorks for comms programs and vice versa. The application requires configuration to access the alternate program. This is a simple process and once you wish to enter an alternate program, life is much easier than it was before. One word of warning however. If you have enhancements on your AppleWorks there may be a problem with reentry of AppleWorks. I had this difficulty and had to remove the enhancement first. Any information on these problems would be gratefully appreciated. Write to me about them or better still put them up on TABBS.

9. Triple Clipboard.

Once more exactly what it says

it is. I am not sure exactly as to how I would use this application. Only one clipboard is active at any one time, which one would expect. One clipboard is enough for me. Again information on its uses would, I am sure be of use to others.

10. Triple Desk Top:

I often put up 12 files in a day and then try to add one more. The usual error message comes up and after a short removal sequence I am off again. Triple desk top enables you to have upto 36 files available which are stored in three desk tops. Movement of these is very rapid and thus much quicker than normal 'removal' of files.

Thus we now have even more enhancements for AppleWorks. Most of these I found useful so perhaps the title 'Powertools' is justified.

There is a hint that one should read the AWP files on the disc. This is a worthwhile activity as it reveals details of other enhancements for AppleWorks

The two Timeout units are sold by Bidmuthin at £49 each. **Keith Rookledge** 

ProSel Update

When I reviewed ProSel in June 1988 edition I had assumed that the package to be fairly mature and that only minor changes and the stamping out of bugs would occur in future versions. It would appear, however, that Glen Bredon keeps adding new features, improvements and even now and again fresh utilities. The main part of the review in June centred about ProSel version 3.0 with some part taken from ProSel version that had arrived just a few days prior to the June deadline. Now version 3.8 has appeared so here is a presentation of some of the changes that have occurred since the review :-

PROSEL.ED

This the external editor utility, now in version 2.9, which allows one to make application screens

and has been greatly improved, in my opinion, since version 3.0. The improvement is a clever routine that allows one to automatically create application screens. When you invoke the external editor you are given the choice between Automatic and Manual entry. If you choose the Automatic option you are presented with a list of all the SYSTEM and SYS16 files on the volume you opted for. Picking the one you require causes the application to be automatically generated. The only change you might want to make is to change the name since the routine uses the name of the file. You can also choose AppleSoft programs providing that a copy of BASIC.SYSTEM resides somewhere in the volume you have chosen.

INFO.DESK

The information desk has had an extra option to the other four in that you can now print out a 'tree' showing the subdirectories on a particular volume.

COPY.GS

This a disk copy program for the Apple IIGs; it will copy all types of disks including RAM disks and borrows as much of the free memory in the machine that is available. If it can copy the whole disk into memory you will be allowed to make further copies without having to read the source disk again.

RAM.DRV.GS

This is a brand new utility for the Apple IIGs computer to make a RAM disk from some of the free memory in the machine and is usually assigned slot 3 drive 1. This RAM disk works only under ProDOS 8 and will be lost when you boot up a ProDOS 16 application. The RAM disk is compatible with the RAM disk that you create from the control panel. **Dave Ward** 

AUG Sweden

Our friends from the Apple User Group Sweden send us three reviews

REVIEW 1: Z-BASIC SOMETHING FOR YOU?

Those who are developing programs on Apple II are a little short of good developing-tools. Investigations in the U.S.A. show that most programmers write their programs in old reliable Applesoft BASIC or in assembly-language. Apple's UCSD Pascal has been the best (only) alternative available for professional program development on the Apple II. However, the last two years have brought on a change, and I intend to present here one of the alternatives: ZBasic by Zedcor Company in the U.S.A.

As the name suggests, ZBasic is a compiling dialect of BASIC. Zedcor calls its product 'Interactive BASIC Compiler' because 'direct compiling' is available for a few editor commands. Furthermore, the compiling is so fast that it almost could be called interactive.

The special feature of ZBasic is that it is available for a number of different computers and is intended to be compatible between them. The idea is that it shall be possible to complete a program on, for instance, an Apple II and then to recompile the program on, say, an IBM PC to make it work on that type of computer too.

In addition to Apple II, ZBasic is available for MS-DOS, CP/M and Macintosh.

The aspiration of making relocatable source code makes ZBasic differ strikingly from Applesoft BASIC on several points. Many commands are more like MBASIC in a CP/M-oriented computer, and many functions are rather 'broad' to

make them easy to move. One example is graphics which offers the programmer a lot of goodies.

In graphics, absolute coordinates are never stated; you work with an imagined resolution of 1024 x 768 pixels. ZBasic recalculates the coordinates to suit the current computer. In standard Applesoft, to draw a line from one corner of the screen to the other you would use the command: H PLOT 0,0 TO 279,159. In ZBasic, the corresponding would be: PLOT 0,0 TO 1023,767. This command would draw a line from one corner to another on all computers, even on a CP/M-oriented machine without graphics!

Since ZBasic is a modern version of BASIC, many a weakness inherent in Applesoft BASIC has been removed. For instance, in ZBasic you can manage completely without line numbers if you wish. Naturally, you can use 'GOTO 100' and similar abominations; in ZBasic you may just as easily jump to a 'label' instead. You create a label by writing, for instance, "Mainmenu" at the beginning of a program line. Then, when you want to jump to it you have only to write GOSUB "Mainmenu". GOTO as well as GOSUB will both be obsolete because you may define your own functions over several lines with the instruction 'LONG FN Function-name' that later may be called by the instruction 'FN Function-name'.

ZBasic has also been improved regarding another weakness in Applesoft BASIC: variable names. Variable names may contain up to 240 (!) characters in ZBasic. The leading 15 char-

acters are significant, as compared with the first two only in Applesoft.

ZBasic has four different types of variables: strings, integers, single- and double precision floating-point numbers. Strings may have 255 characters and must be given dimension; if not, a default-value of 255 will be used.

Regarding mathematics, ZBasic can have a maximum of 54 digits in calculations, but in that case you must have plenty of time...

Structured programming is likewise made easy, because WHILE-WEND as well as DO-UNTIL are included in the language, also LONG IF THEN-ELSE-ENDIF.

In ZBasic you may mix graphics and text on the screen, and, as far as I know, it is the only language capable of handling 'double hires' on 128k machines. You can use a standard AppleMouse or joystick and mix Videx-compatible 80-column cards with Apple's own cards. Furthermore, ZBasic does manage Super Serial Card and the ports of Apple//c.

As has been previously mentioned ZBasic is a compiling BASIC but it compiles so fast that you never feel any interference or delay. Of course, if you have no RAM-disk the compilation takes considerably more time, but ZBasic must still be considered to compile very fast.

The result of compilation is a B-file under DOS 3.3 or a SYS-file under ProDOS. Under ProDOS one or three (128k-version) runtime -files are needed.

Another pleasant quality of ZBasic's is that you don't have to pay royalties to use the runtime files in your own programs.

There are four versions of ZBasic that can be used on the Apple II:

If you have a CP/M-card with your Apple II you may use the CP/M-version of ZBasic.

There is a DOS 3.3-version that requires 128k of memory for program developing; the program may then be run on a 64k computer.

There are two versions for ProDOS (both versions are

included in the price), one for 64k computers and the other for 128k 'enhanced' //e, //c and IIGS. My recommendation is to use the 64k-version on the following grounds: firstly compatibility with 'smaller' machines, secondly speeding up compiling by being able to have in memory a /RAM disk. In a 128k-machine that prevents shuttling the compiler between the disk and the primary memory. There is a nice little full screen editor accompanying the ProDOS-version in addition to the line editor which is the same for all versions.

The only objection to the full screen editor is that it does not use the same Apple-keys as AppleWorks; an Apple key plus a digit are used instead, obviously an inheritance from IBM's function keys.

ZBasic is delivered on a non-protected 5.25-inch floppy disc and with an excellent manual containing about 500 pages. It may be bought from Zedcor's Swedish retailer Reda Nova of Storebro and the price is Sek 995:-, VAT and postage not included.

Personally I recommend the ProDOS version which I use myself for program development when I'm not using assembly language.

SUMMARY: ZBasic - DOS 3.3: 128k Iie, //c, IIGS for programming; 64k for running. ProDOS 128k: 128k 'enhanced' //e, //c, IIGS for both programming and running. Additional Ram-memory (RAM-disk) strongly recommended for programming. £76.95 inc VAT from MGA

/Per Lindstrom

Translated by Paul Mitlid

REVIEW 2: MEGABOARD HARD DISC CONTROLLER

In the beginning of 1988 I read an advertisement in the A+ Magazine about a disk controller board to which could be connected such hard disks as are generally used with IBM PC and compatibles.

With MEGABOARD in a slot in Apple II+, Iie or GS you could buy moderately priced hard disk drives, able to store, from 20 MB

to 60 MB of data. You would then be able to access a gloriously large data base. There was nothing to hesitate about so I ordered a card for delivery as soon as possible.

When the board finally arrived, I had only to start installing it, following the manufacturer's directions. These, however, dealt only with Apple II+ and Iie, not the GS. Still, it appears that, concerning the Apple II GS, you have to install MEGABOARD in slot 6 at present; later on it will be possible to use slot 7 as well. In all other Apple computers you can install the card in any slot except slot 0; it thinks it is in slot 7 wherever you place it.

You start by formatting the hard disk, which takes about one minute per MB. Thus it takes about twenty minutes to format a 20 MB disk. Then you must partition the disk, depending on how many operative systems you want to have at the same time. The card accepts four operative systems: DOS 3.3, ProDOS, CP/M and Pascal. You can have as much as 38 volumes of DOS 3.3, corresponding to 76 floppy disk drives! Notice that each volume has two drives (D1 and D2). With CP/M you can have as much as 6 drives. It's the same with Pascal, a maximum of 6 drives.

When you arrange the disk for the operating systems you are going to use, you might let the disk know, simultaneously, which system you are going to use for booting; my choice was ProDOS. Then I decided to have a single DOS 3.3 volume, (at least one volume is mandatory), the remaining part of the disk forming one large ProDOS volume (maximum ProDOS volume is 32 MB). This arrangement gives me permanent storage for about 19 MB, around 39000 blocks, to be divided between various ProDOS programs. Before getting the hard disk I had only 1600 blocks on a 3.5" disk, not to mention a paltry 280 blocks on a 5 1/4" floppy disk, which was the only permanent storage I had in the beginning. The space which I now have on my hard disk is equivalent to 140 floppy disks 5 1/4" plus one 3.5" and one 5 1/4"

4" drive.

You can use MEGABOARD with hard disks, made by the following manufacturers: Seagate, Maxtor, Teac, Lapine, Rodime and Miniscribe, but only if the hard disk has less than 64 MB, has 2, 4, 6 or 8 heads and not more than 1024 cylinders.

The price of the MEGABOARD is \$195 plus freight, about \$10. It may be ordered from:

Perlin Electronics, Inc 7394
Calle Real, Suite E GOOLETA,
CA 93117 U.S.A.

/Birre Genberg

Translated by: Paul Mitlid

REVIEW 3: NO-SLOT CLOCK

Why should one have a clock in one's Apple II? Until last year I had only used the DOS 3.3 operating system and my opinion was that clock cards weren't necessary. If you want to know the time, you have your wrist watch or a wall clock. On the other hand, you must have some sort of system to keep your various files in order, especially slightly different versions of, say, a new application program which you are developing. A common method is to name the consecutive tentative versions TEST, TEST1, TEST2, TEST.OLD, etc, etc... and we all know the result: you can't remember which one was the latest version. A clock in the computer might be another, better solution.

A year ago I began (reluctantly) to use ProDOS, and now I am using it to 98 %. After some time I realised that ProDOS was able to register time and date; surely all of us have seen the message <NO DATE> only too often. Later, when I started using AppleWorks, I soon grew tired of typing the date every time I started the computer and, to make things worse, to have to do it in the absurd American way, putting the month first, the day second and the year third. I could sit quite a while trying to hit the keys in the right (wrong) sequence.

In connection with my beginning to use ProDOS I started to convert my own invoicing pro-

gram from DOS 3.3/Applesoft to ProDOS/ZBasic, not an entirely painless operation. As I was making changes to my program anyhow, I thought that this was an excellent occasion to develop the program a little further (that is, to put in a few extra bugs).

When I was juggling half a dozen versions of my program around at the same time, I realised that some sort of order had to be observed. So therefore I began using a little routine in which I recorded date and time manually, which was then "poked" into ProDOS. All of a sudden I was spared from having to see this irritating <NO DATE>. What a relief! But there were disadvantages. I often forgot to load the routine before I started the ZBasic, and if I produced several files during the same session they all had the same time. One night I was alternating between ten different versions, all having the same time!

No, it was high time for getting a clock, but how? My //e hadn't a single slot free and I wouldn't contemplate giving up one of my cards to swap it for a clock card. Well, a combination card then; there are several on the market, the most common a series card with a clock. However, advertisements started to crop up in American computer magazines about a gadget called No-Slot-Clock. It wouldn't occupy a slot and should be the very thing for me.

What is a No-Slot-Clock? It is a clock/calendar in the shape of a ROM, or, if you prefer that, the other way round. Thus it doesn't occupy a slot. It is provided with two Lithium batteries which supply current to the clock when the computer is shut off. The batteries are supposed to last for ten years. I haven't the slightest idea about what happens after that, it seems impossible to change the batteries. No-Slot-Clock has year, month, day, hour, minutes, seconds and hundredths of seconds. If you must be able to read seconds and hundredths of seconds you have to use a special program because ProDOS is only concerned with hours and minutes. In addition to ProDOS, No-Slot-Clock can also be used with

DOS 3.3, and it fits Apple //e, //c and IBM PC computers. My own No-Slot-Clock sits in an //e. It is possible that No-Slot-Clock might be used with an Apple II+, but there is nothing written in the manual about that. On the other hand it says that No-Slot-Clock should function with almost every type of computer that has a 28-pin ROM.

Installation. No-Slot-Clock is delivered with a loose-leaf manual (you have to supply a cover according to American standard yourself) and a floppy disk. The manual and disk are designed for use with Apple and IBM. In fact, you may move a No-Slot-Clock directly to an IBM PC computer (but there is no reason whatsoever to do that, is there?). The Apple side of the disk is a hybrid side, containing ProDOS as well as DOS 3.3, but you have to start up in ProDOS. You have to use a DOS 3.3 filecopy program to get at the DOS 3.3 files. The manual is easy to understand, perhaps a bit too inclined to lose itself in details. Installation of the No-Slot-Clock hardware in the computer is simple. Very carefully you remove a 28-pin ROM and in its place you push the No-Slot-Clock down. Then you push the ROM down on top of it; you "piggyback" the ROM on top of the No-Slot-Clock. Needless to say, the computer must be shut off during this operation and you should touch the power supply box a few times to get rid of any static electricity on your person. In other words, if you have some experience so that you feel sure that you are able to change and install cards you should have no problems with the No-Slot-Clock.

Well, that was what I thought. But it was not that easy. It appeared that the distance between pins on the Clock is a tiny bit too large. It didn't fit properly in the empty ROM socket. This isn't true for all Apples, it varies between different units. I tested the Clock in another Apple where it fitted perfectly. To keep my No-Slot-Clock in its place in my computer, I placed a two-pound weight on top of it, but then it was impossible to put the top

back on the computer.

Finally, at long last, a test run! The first results were very disappointing. The Clock start-up program seemed to work all right, I could read the No-Slot-Clock and set the time and date. But when I patched ProDOS on my own disks the programs crashed. Disappointed I removed the No-Slot-Clock and had a tough job copying a pure ProDOS back to all my disks.

Well, shame on him that gives up. Perhaps a two-pound weight in an Apple isn't the right thing. I visited an electronics shop and placed my problem before them, explaining that the No-Slot-Clock pushed the ROM out of the socket because it was too wide. A small gadget fitting in the empty ROM socket in the Apple solved the problem, and it was possible to push the No-Slot-Clock down correctly, into the gadget, and lock it there. #8.5 the poorer I had now good contact for the Clock as well as for the ROM.

Unfortunately the Clock start-up program accompanying the No-Slot-Clock is confusing and bug-ridden. You have to tell the program where in the computer the No-Slot-Clock is placed. By the way, you may even mount it on an expansion card (which I haven't tested). If you let the program search for the position of the No-Slot-Clock, it will report that the Clock is on a card in Slot 3, although you know for sure that it is sitting on the mother-board. I worked with this problem so many times that I can't account for them all, and used so much time that you wouldn't believe me if I told you.

The solution: copy the Apple side of the Clock start-up disk onto a new, empty disk, and, this done, put the original Clock start-up disk away. A truly pure ProDOS, version 1.4 for instance, should then be copied onto the new disk with the Clock start-up program. Test your ProDOS for pureness by trying to read the Clock, and if it is pure, the Clock should show zeros only. Now run the Clock start-up program and don't mind what it says about the position of the No-Slot-Clock. You have now a patched ProDOS on the disk you first copied to.

You should then copy it onto your own data disks instead of using the original Clock start-up program. It is faster to do it this way and safer, I think, considering how lousy the program is.

At last! The Clock successfully booted! When finally I had succeeded in starting-up the No-Slot-Clock in my Apple and patched ProDOS. I started copying the patched ProDOS onto my own ProDOS data disks. So far I haven't found a single ProDOS program that doesn't work with the Clock, and I don't think I will. All programs reading ProDOS time/date will give the correct time, provided they are ProDOS, No-Slot-Clock patched. AppleWorks reads the date and you have only to press RETURN, or patch AppleWorks to "push" RETURN itself. Either way, it is very pleasant to be spared from always having to print the date.

Setting a No-Slot-Clock precisely requires a watch or clock with a second-hand. It takes the

program two seconds to adjust No-Slot-Clock to the correct time after you have set it. The Clock seems to be about one minute slow per month. These two minor problems also seem to affect the Apple II GS.

After having used the No-Slot-Clock for more than three months I can't imagine living without a clock/calendar in my Apple.

Summing up. If you are using many programs requiring date, for instance AppleWorks, or, if you yourself program under ProDOS, you ought to have a clock. In that case No-Slot-Clock is a very good alternative to common clock cards. - No-Slot-Clock does not occupy a slot. - It's less expensive than an ordinary clock card. I have seen No-Slot-Clock advertised in A+, Nibble and InCider magazines at a prize as low as USD 42, naturally plus customs and VAT. Once you have succeeded in installing the No-Slot-Clock it minds itself and the only thing

you have to do is to set it from time to time. I can strongly recommend No-Slot-Clock to everyone needing a moderately priced, reliable clock/calendar.

Facts:

Price about \$42, plus customs and VAT

Manufacturer:

SMT Inc.
1145 Linda Vista Drive,
San Marcos,
CA 92069, USA

/Andreas Wennborg

Translated by: Paul Mitlid

Andreas can be reached on TABBS. We are exchanging reviews and articles with the Swedish Apple User Group. This group is for Apple II and was set up to provide a forum for Swedish users left in the cold by the policy of Apple (Sweden) not to support the II series in any way.



Computer Consumables...

PRINTER RIBBONS	£. each		£. each
Apple Imagewriter II	3.35	Epson LX 80/86	2.75
Brother M1009/1109	2.95	Epson LX 800	3.15
Cannon PW1156/1080a	3.05	Epson FX 80/85/800	3.15
Centronics GLP	2.95	Epson FX 100/1000	3.55
Citizen 120D	4.05	Juki 5510/5520	3.15
Epson EX800/1000	4.60	Kaga KP 810/910	3.05
Epson GX 80	2.75	Mann/Tally MT 80	3.35
Epson LQ 500/800/850	3.35	Seikosha GP 100	2.40
Epson LQ 1000/1050	4.00	Shinwa CP 80	3.35
Epson LQ 1500	3.05	Star Gemini	1.35
Epson LQ 2500	5.15	Star NL10	4.70

DISKS, packs of 10, with labels etc

3.5" Sony disks, DS, 135 tpi	18.50
3.5" bulk packed, DS, 135 tpi	9.80
5.25" bulk packed, DS, 48 tpi	3.60

All prices include VAT and delivery
ACCESS card accepted, telephone 0689 22196
**T-systems Ltd, The Signal Cabin,
61 High St., Orpington, Kent, BR6 0JF**



PC Transporter

This successful addition to the Apple II reviewed from a users point of view!

In the second article on this potentially revolutionary piece of hardware, Geoff Wood looks at the transporter from the users point of view.

Do you want to run both MS-DOS and ProDOS applications in your Apple II? If so, PC Transporter is the answer. It's a plug-in card made by Applied Engineering who are well known for their RamWorks and RamFactor cards. You may also need their 5.25" disc drive for MS-DOS 5.25" discs but you can use an Apple 3.5" disc drive (not the UniDrive) for MS-DOS 3.5" discs.

The Card Itself

The card can be used in the Apple II+, the IIe and the IIGS but the IIGS uses a different installation kit from the II+ and IIe. The II+ also needs their IBM-style keyboard which is an optional extra for the IIe and IIGS.

The card has a 16-bit V-30 microprocessor with full 8086 instruction set operating at 7.16 MHz so it runs three times faster than an IBM PC/XT but not faster than some PC clones. It has a set of ram chips giving from 256K to 640K in IBM mode (384K to 768K in Apple mode). It also has a socket for an 8087-2 co-processor chip for fast number-crunching.

The card functions as a universal disc drive controller for 5.25" and 3.5" MS-DOS disc drives. It can support up to 5 drives but only four drives can be physically connected to the card. For example, you could have a 360K dual 5.25" drive connected to the card with two daisy-chained Apple 3.5" drives and a ram card used as an IBM hard card.

In addition, you can have the

normal complement of Apple ProDOS drives P 3.5" or 5.25" or both P coupled to the IIGS disc drive outlet or to disc drive controller cards in a II+ or IIe. Special software is supplied to allow you to transfer files from ProDOS to MS-DOS or vice versa.

What it can do

PC Transporter can configure most ProDOS hard discs for MS-DOS storage without disrupting the ProDOS files. It can also use 3.5" discs as MS-DOS hard disc volumes. However, MS-DOS never expects a hard disc to be removable so you must take care not to change a 3.5" disc that MS-DOS is using as a hard disc.

The card comes with a hefty 190 page A4 manual, though the first 70 pages are concerned with installation of the hardware and software in the three models of Apple II. Even a novice would have no trouble following the clear instructions, diagrams and photographs. The next 25 pages describe the operation of the system, then there are 20 pages on MS-DOS matters, 8 pages on keyboard differences, 35 pages on disc drives, 15 pages on printers and 15 pages of appendices.

Testing the card

I tested the IIGS version with a colour monitor and must say that I was very impressed. Installation is easy. You just plug the card into any slot except slot 3, attach the colour card to the back panel, connect the two cards with the cables supplied, plug in the disc drives and the monitor, then switch on.

Initially, I had some problems with a zigzag display with the card in slot 4 and the colour card alongside it. I moved the card to

slot 7 and mounted the colour card above slot 1, as recommended in the manual. It then worked perfectly but I am not sure whether the problem arose because the cards were too close together or whether there was a poor connection somewhere.

The Software

The software is supplied on a ProDOS 3.5" disc and on two sides of a 5.25" disc. You place the startup disc in the appropriate Apple drive and switch on. (A warm boot can be done from Basic or ProDOS.)

After a few seconds in which the startup screen displays messages from "Little Blue Limited", a memory test takes place and the screen shows the amount of memory. PC Transporter then looks for a bootable MS-DOS disc in drive A. If all goes well, the MS-DOS operating system is loaded into PC Transporter and the MS-DOS system prompt A: \> is displayed.

Starting Up

The first time you start up, you will need a bootable MS-DOS disc with at least 120K free in order to copy some files from the PC-Transporter disc to what will become your MS-DOS boot disc. These files include a clock driver which will read the IIGS system clock (or a suitable clock in a II+ or IIe) when you start up in future. They also include drivers for an Apple mouse.

You will also need to configure the system to suit your arrangement of disc drives. This is quite easy to do from the PC Transporter main menu which is accessed from MS-DOS by holding down the shift key and pressing the caps lock key twice. One of the options on this menu is to configure the drivers and this in turn brings up sub-menus which allow you to specify the location and type of disc drives. You can also specify whether you have the maths co-processor and a mouse.

Configuration

The configuration can be saved on the ProDOS startup disc so you don't need to configure each time you start up. If you change the configuration, you must re-boot the system otherwise it may not recognise the changes and you could lose some data.

One nice feature is that you can use the special PC Transporter drives to save ProDOS files and you can also use Apple disc drives to save MS-DOS files. If an Apple disc drive is plugged into an Apple controller card or IIGS port, the MS-DOS files are saved with GCR (Group Code Recording) techniques, as used by all Apple disc drives, whereas PC-compatible drives use MFM (Modified Frequency Response) techniques. You can copy such discs with the ProDOS system utilities but you cannot see the catalog or access the files from ProDOS.

Another option on the PC Transporter main menu is to display the Apple Keyboard Map. Although there is a diagram in the manual which you could refer to when you forget which key to press, this screen map can be accessed at almost any time from within an MS-DOS program.

Differences

The main difference between the IBM keyboard layout and the Apple II layout is that the former has ten special function keys. These are emulated on the Apple keyboard by holding down the solid apple key (option key on the IIGS) and pressing the appropriate number key.

On the IIGS, the numeric keypad emulates the keypad of a PC-compatible so that 7 acts as the Home key, 1 as the End key, 9 as PgUp, 3 as PgDn, etc. On the IIc, the keypad keys are emulated by holding down the Solid Apple key and pressing one of the top row of character keys. On both the IIc and the IIGS the Open Apple (command key) acts as the Alt key.

Once you have started up you can run almost any MS-DOS program, including such favourites as Lotus 1-2-3, dBASE II & III, SuperCalc 3 & 4, MultiMate, Wordstar, Word 3 & 4 and even Flight Simulator.

Problems?

I had no problems running the spreadsheet and word processor programs. The colour display on the IIGS was excellent. The IIGS colour monitor is analogue and it gives sharper images than an IBM CGA digital display.

I copied some files from SuperCalc 3a (ProDOS) on to an MS-

DOS disc and loaded them into SuperCalc 3 & 4. Similarly, I copied some files from VIP Professional in ProDOS and loaded them into Lotus 1-2-3 in MS-DOS. I also tried the transfers in the reverse direction and had no problems.

Printing

If you have an ImageWriter II it can be used as an IBM Graphics Printer. The PC Transporter software includes a driver for this purpose but you can also use other printers such as Epson, Okidata, Diablo and so on. There are drivers for both parallel and serial printer cards including the Apple Super Serial card and the IIGS serial ports.

The section of the manual that covers printers and printer cards is not as easy to follow as the sections that cover installation of the hardware. No blame need be attached to the authors of the manual. It's just that IBM systems are inherently harder to understand than Apple systems.

Switching languages

You can switch easily and quickly from MS-DOS to ProDOS by using the PC Transporter main menu but you must remember to save your data before switching. There is less danger of losing data when you switch the other way because you have to quit the ProDOS program and boot MS-DOS; most good ProDOS programs warn you about saving when you try to quit.

Cost

As you would expect with Applied Engineering products, the PC Transporter is well designed, well made and seems reliable. The only problem is price. The card that offers 256K is £299 but many MS-DOS programs need more memory so it is advisable to go for the 640K version at £399. These prices exclude VAT.

To this must be added the cost of the installation kit (£39 for the II+ and IIc, £49 for the IIGS). With an Apple II Plus you also need the keyboard which costs £115. If you need the 5.25" disc drives as well, they cost £159 for the single drive and £259 for the dual drive. So a dual drive 640K system for a IIGS costs £707 (plus VAT) and for this price you could buy an Am-

strad 1640 with colour monitor and dual drives.

Conclusions

However, the attraction of PC Transporter is that you can switch from ProDOS to MS-DOS very easily and quickly. It means that you can transfer files from one system to the other with only one computer on your desk.

If you do not already have a ram card for your computer, PC Transporter may be an attractive buy because it offers up to 768K of extra ram for use with your Apple programs. Indeed, the card comes with a free copy of the latest version of Applied Engineering's AW 2 Expander program which modifies AppleWorks 2.0 to give up to 22,600 records in the database (compared to 6,350), 22,600 lines in the word processor (compared to 7,250) and 2,042 lines on the clipboard (compared to 250). This program also allows you to use AppleWorks on the II Plus. It lets you save large files on two or more discs and it offers on-screen time display.

In the end, you take your choice and pay your money. I can't see vast sales for PC Transporter but it meets the requirements of a niche market and could be just the thing you need.

Availability

PC Transporter is available from Bidmuthin Technologies Ltd, Brent House, 214 Kenton Road, Harrow, Middlesex, HA3 8BT.

So there you have it, two views on whether Apple // owners should give their machines the ability to run MS-DOS programs on their trusty machines. The solution seems a little pricey for a toy, but if you have a genuine application then the value could be enormous.

Our thanks to Holdens Computer Services and Bidmuthin Technology for their assistance in preparing the two articles on the PC Transporter.

The series will conclude in the next issue with a configuration table, showing all the hardware options of the PC Transporter.

Geoff Wood



The Nibbler's Corner

The Nibbler takes his monthly look at the Apple scene

I have two apologies to make this time, first of all to the Macintosh members who have complained about the increase of space given over to the Apple II. Secondly, I apologise to the larger number of Apple II members who have sent letters of support to us after re-joining the group. Our declaration that we are firmly committed to helping them is the reason for their renewal.

Apple2000 (BASUG) has firmly imbedded in its constitution that it supports the entire range of Apple machines, either existing or to come. What other User group can claim that? We can't please everybody, but we can try and balance our support across the range. Of course if those Macintosh members with Desk Top Publishing facilities would offer their time and help us write and publish the magazine, we might be able to go monthly. There's a thought ...

An item that I mentioned some time ago has produced a response. John Lee has a copy of the Business Graphics Manual, and would be pleased to help the member concerned. Get in touch with John, you will find his number on the contents page.

You will see mention of the new GS System disc 3.2 in other parts of the magazine. The new disc has a much improved AppleTalk structure, and also has more printer drivers. It is also faster to boot, booting to the Finder in 54 seconds instead of 67. There seems to be a new way of handling fonts by means of font lists, but without the documentation (it is on its way ...) I do not how these are handled.

The System disc disc is available from MGA in Kent, but to my way of thinking ought to be issued as

a free update from Apple UK through the dealers. It appears at the time of writing, that Apple UK will not issue this disk, as there is rumour of a new System 4.0 later in the year. Reading between the lines, I would expect the System 4.0 disc to be a full ProDOS 16 implementation, and not the hybrid we have at present. It should also read and write in Macintosh style format, this would allow us to finally break the 32 meg barrier, and to interchange data with our compatriots. Disc loading should also speed up at last using this disc format. With a Macintosh emulation card in a spare slot (come on Cirtech, you can do it ...), and a PC Transporter in another, the IIGs would be every machine that one might need in one box! Of course we would still be able to load our DOS 3.2 Systems disc and run Applevision. Could the Mac II ever boast that kind of compatibility, at the price of a GS?

On the rumour front again I was interested to see a file in the GS section of TABBS that implied we are due for an upgrade of the IIGs motherboard. This would have a faster clock (about time too) and have a new video mode with 400 lines vertically. It would also support 256 colours instead of 16 in any line. This gives us almost the resolution of the Mac with the colour of an Amiga. Using separate palettes on each line we can of course increase the number of colours way beyond anything we could have hoped for in the old Apple II. If this motherboard comes into being, will Apple UK provide the upgrade, or will they expect us to buy the whole new machine?

The announcement of the new Cirtech PlusRAM boards is mindblowing. I use a Mac SE at

work for desk top publishing and other graphic uses. The main limitation of that machine is the need to layer program and data to disc as the memory becomes full. I know that the SE can be added to in stages to 4 megabytes, but my IIGs can be expanded up to 8 meg with an additional 1 meg ROM all in system memory. The SE can have a number of SCSI hard drives added, my IIGs can only have four of 32 meg maximum each (at the moment ...), but I have lots of slots to add Cirtech cards in as well. With the new PlusRAM-16 I can have up to 32 meg internally and still have two hard drives, two 3.5 drives and my printer port, mouse and 80 column screen. That is all in addition to my 8 meg system memory and 1 meg ROM. If I dispense with some of the slots, I can raise this level to 80 meg internally, plus an 8 meg system, 1 meg ROM and two 3.5 drives ... who wants a Macintosh with this kind of memory about in an Apple II? Mind you, there are no programs about yet that can use this kind of memory, but if past experience is anything to go by, it is only a matter of time till someone writes one

I visited the MGA sale at Apple-dore August Bank holiday and picked up a few bargains. It is always pleasing to see that there are still a great deal of enthusiasts out there who still support the Apple II, nearly all of them are using their Apple II machines for business or educational purposes. It was also nice to meet Jon Gurr as well from the first time. Jon is a champion of the Apple II and deserves our full support. If you visit him at PearTree, beware of the local scrumpy cider! It may make you buy more than you bargained for!

The Nibbler

To reply to any of the articles in the magazine, to the letter pages or simply with information, send preferably on a disk (any form of Apple disk, it will be returned), either to:
Apple2000, PO Box 3,
Liverpool L21 8PY,
or post on Telecom Gold
84:BSG005, or leave in the
Apple2000-Magazine area on
the TABBS Bulletin Board

The Vapour Condenses ?

Dave Ward at last gets hold of a Zippity Doodah and finds it works !

For the last 12 months or so we have been bombarded by advertisements for Zip Chip the 'speed-up card' on a chip for Apple // range of computers. Well, thanks to MGA Microsystems, we have at last got one for reviewing.

The Zip Chip arrived in a very well padded box measuring 31 by 21 by 4.3 centimetres. Inside is a 26 page manual, a floppy 5.25" diskette of utilities and, of course, the Zip Chip itself with a 'free-of-charge' Zip Chip removal tool. The chip itself is clearly larger than the 6502 chip it replaces and measures 5.2 by 2.2 by 0.7 millimetres.

The first ten pages of the manual deal with the installation of the Zip Chip into Apple II, Apple II plus, Apple //e and Apple //c computers.

I found that the installation of the ZipChip was not that easy on my Apple //e enhanced machine, as the manual lead me to believe. First the instructions are given for the American machine ; the 65C02 chip in the Irish machine is in a different place but, all the same, well marked on the mother board. The chip remover supplied with the ZipChip did not work too well as a lever because the 65C02 chip overhangs the socket a little. It still only took me 10 careful minutes, though. The ZipChip also overhangs on all sides so that it is difficult to see if all the pins are in their correct places. Fortunately the pins are quite straight and I found no problem in installing the ZipChip. William Watson suggested that the chip remover would work better by being moved from side to side rather than being used as a lever. This

method was found to work extremely well and used in all subsequent installations.

Installation in a Apple II Europlus appeared to be much easier and the chip remover worked better. The ZipChip was easy to install but the machine did not appear to work properly the first time. Removing the chip and then replacing it more firmly did the trick; it is imperative to ensure that the Zip Chip is well seated in the 6502 socket.

We had no problems in installing the Zip Chip in Apple // c computers even those where the Zip Chip was piggy backed on a Multi-RAM board.

Once the Zip Chip is installed you simply switch on the machine and after a wait of a little over 2 seconds you will hear a high pitched beep and the machine then boots up as normal, except that things run much faster; Zip Chip runs perfectly with most hardware and software configurations with, usually, better than 300% increase in speed. Later we'll look at some hardware installations and examine the effect of Zip Chip on some software packages.

The utilities diskette supplied 'free' with the Zip Chip has ProDOS based utilities on the front side and DOS3.3 based utilities on the flip side. Here is a listing of the files on the ProDOS side of the diskette (see figure 1).

The diskette is copyable by normal means and you are urged to make a copy for your daily use, which you'll require if you ever want to use a different configuration of the Zip Chip.

When you boot the ProDOS side of this diskette you get the following menu (figure 2).

Figure 2 - Main utility menu

```
MAIN MENU  ZIPCHIP II  1.00

      CONFIGURE INSTALLED

A)  RUN ZIP DIAGNOSTICS
B)  RUN ZIP SYSTEM CHECK
C)  RUN ZIP CONFIGURER
D)  RUN ZIP INSTRUCTIONS
X)  EXIT MENU

      WHICH?
```

The manual suggests that the first thing you do after installing the Zip Chip is to choose options A & B from the menu, (in figure 2), after booting the Zip Chip utilities diskette. These take a few minutes but is worth it, as a very comprehensive tests are carried out. We will look more closely at option C the Zip Configurer later and the Zip Instructions are a text-file version of the manual. It is worth reading the text-file manual as it could contain updated information not available at the time of printing of the manual.

Certain programs such as games will be virtually unusable at the full speed. Also certain hardware will not be compatible with the processor running at 'system' speed of 4.0 megahertz. Fortunately the Zip Chip can quite easily be run at normal speed by the simple expedient of pressing the ESCape key just after booting but before the 'beep' is heard. On the Apple // e and Apple //c computers you can simulate a cold boot by pressing the Open-Apple + Control + Reset keys at once. When the Zip Chip is installed this procedure becomes more critical and you should use the following procedure. Press the same three keys but don't release the Open-Apple key until you hear the high pitched 'beep' indicating that the Zip Chip is now working at 'system' speed. (Like the manual we will refer to the 'system' speed as the Zip Chip speed and normal speed as the original Apple // speed.) On booting this way the Zip Chip will use its default settings (see fig. 3). To run the Zip Chip

Bidmuthin's A-Z of //GS solutions.

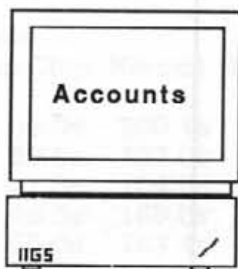

Accounts

A complete GS accounts system, seamlessly integrating sales, purchase and general ledgers with invoicing from stock, stock control & management reports. Brilliantly easy to use and fast. Designed for the non accountant.

Options Include RAMcaching macros.

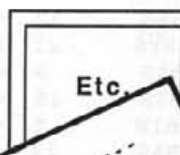

Etc.

Yes, once you've drawn a few boxes you run out of great ideas. Or do you?

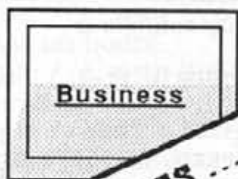

Business

Based on 4 enhanced ties

STOP PRESS - MANY NEW IIGS ITEMS IN STOCK -

Hardware.....Hard Disks...Hard Disk Sharing...LaserWriter IINT connectivity...Battery Packed RAM - Main slot...Battery Packed RAM - Memory Slot...Two Memory Cards in one memory slot...PC Transporter now expands AppleWorks...Hard Disks run MS-Dos...Keyboard Extender Cables...Mouse Pockets...MousePads...RGBMonitor Extender...Cables...IIGS as Colour TV Set...Connectivity to other computers, including Psion Organiser, Cambridge 288...Printer Muffler and Interface...AppleTalk sharing of ImageWriter & LaserWriters...UltraMacros, Superfoats, QuickSpell, Graph, FileMaster, SideSpread...Coming soon...Thesaurus, PowerPack, Communications and TimeOut Accounts...Now available in stock for DeskTop Publishing: GraphicWriter II - full LaserWriter IINT, NTX support. Also Publish R. MultiScribe Version 3.0, Database includes ProFiler and DE Master Professional...AppleWorks...New DeskWorks Accessories for ProDos 16...System Disk for IIGS (Finder) available for AppleWorks...New Style Games...High graphic quality including the new CinemaWare...All IIGS now V3.1revised...New Style Games...Educational discounts available

Systems and configurations in stock...Educational discounts available



Drawing

Draw is a magnificent drawing program for the //GS only. It is object orientated, with masses of features. Like a colour version of MacDraw. Integrates with MultiScribe for desktop presentations.

- Printing
- Quality support
- RAM
- Science
- Training
- Utilities
- VIP Professional
- Word Processing
- Xtra memory
- Zork Trilogy - after that lot everyone needs a break!

These are just some of the systems we can offer. If you have a problem, why not let us recommend an answer. We guarantee it will meet your requirements.

Bidmuthin Technologies Ltd.
 Brent House
 214 Kenton Road
 Harrow
 Middlesex HA3 8BT
 Telephone 01-907 8516

Apple Authorised Resellers
 Level 1 Service Centre
 Apple // series & Mac

Figure 1 - catalog of Zip Chip utilities diskette.

```

/ZIPCHIPII

```

NAME	TYPE	BLOCKS	MODIFIED	CREATED	ENDFILE	SUBTYPE
*PRODOS	SYS	32	<NO DATE>	<NO DATE>	15485	
*BASIC.SYSTEM	SYS	21	18-JUN-84	0:00	<NO DATE>	10240
STARTUP	BAS	3	<NO DATE>	<NO DATE>	1008	
ZIP.DIAGS	BIN	18	<NO DATE>	<NO DATE>	8704	A=\$4200
ZIP.SYS.CHK	BIN	5	<NO DATE>	<NO DATE>	2048	A=\$4800
ZIP.CONFIG	BAS	14	<NO DATE>	<NO DATE>	6178	
ZIP.INSTRUCT	BAS	5	<NO DATE>	<NO DATE>	1693	
ZIP.MANUAL	TXT	69	16-JUN-86	0:00	<NO DATE>	34692 R= 0
ZIP.STARTUP	BAS	1	<NO DATE>	<NO DATE>	152	

BLOCKS FREE: 102 BLOCKS USED: 178 TOTAL BLOCKS: 280

at normal speed from a cold boot make sure that you press the ESCape key immediately after pressing the Reset key and ensure that you still press the Open-Apple key until the you hear the normal 'beep'.

Figure 3 - Default settings

System Speed: 4.0 megahertz
 Slots Fast: 1, 3 and 4
 Paddles: Normal
 Speaker: Fast

Most users will be happy with the default set-up of the Zip Chip and the ability to it as if it were a normal 1.023 megahertz 65C02 processor. It is, however, possible to alter these defaults and even make a pre-boot disk to customise those settings to meet your own needs. You will see the default settings (figure 3) have been well thought out to meet the requirements of most users. Slot 2 used by modems and slots 5,6 and 7 often used for disk drive interface cards have to be accessed at normal speed. In fact your disk drives will damage your diskettes when writing at anything other than the normal Apple // speed. So if you wish to use a disk drive in slot 1 or slot 4 you will have to configure Zip Chip to access to cards in these slots will be at normal speed. When you boot your Zip Chip utility diskette you will see the menu in figure 2. Choose option C from that menu and you will soon be greeted with the configure menu (see figure 4).

This menu is straightforward and is very well described in the manual. When you have fin-

ished type X to exit and you will be requested to save the configuration.

Y - writes the configuration to disk.

ESC - allows you to emend the configuration.

Any other key configures Zip Chip but does not save the configuration.

Any particular configuration remains extant until the machine is switched off or a cold boot is performed.

You can simply copy a couple of files from a utility diskette you have configured to another diskette so that Zip Chip is automatically configured on boot-up. Alternatively you could run the configure program whenever necessary without saving the configuration to disk. ProSel users could, for instance, create an application to run the configuration program as and when necessary. This is what I did and it works quite well.

So far Zip Chip looks very good and some games are almost unplayable as they run so fast. Business applications also appear much faster but how fast? Below are a series of timings carried out on various serious software on a variety of Apple // systems.

Comparisons with the Apple IIgs (using it's very own 65SC816 microprocessor at 2.8 mega hertz), where appropriate, and the Speedemon card have been included for interest.

Figure 4 - Zip Chip configurer

```

CONFIGURER    ZIPCHIP II-4    1.00

```

A) ZIPCHIP	ON
B) ZIPCHIP SPEED	4.0000 MHZ
C) LANGUAGE CARD	CACHED
D) PADDLE SPEED	NORMAL
E) SPEAKER SPEED	FAST
F) SLOT 1 SPEED	FAST
G) SLOT 2 SPEED	NORMAL
H) SLOT 3 SPEED	FAST
I) SLOT 4 SPEED	FAST
J) SLOT 5 SPEED	NORMAL
K) SLOT 6 SPEED	NORMAL
L) SLOT 7 SPEED	NORMAL

1) AppleWorks

AppleWorks is perhaps the most widely used package on the Apple // range of computers so a variety of timings for the most popular systems have been tried as follows :-

Spreadsheet 139K and 850 rows

The following table shows the time taken to do a re-calculation on the whole file.

System:

	Zip Chip	Normal	% increase
1	13.2s	43.0s	326
2	15.0s	46.2s	308
3	14.9s	47.3s	317
4	14.8s	45.5s	307
5	16.8s	42.1s	251

Spreadsheet 285K and 900 rows

System:

	Zip Chip	Normal	% increase
1	33.0s	108.4s	328
3	36.9s	118.3s	321
5	43.7s	110.2s	252

Wordprocessor 66K 1654 lines with 37646 words

The following table shows the time taken to change all of the 550 occurrences of THE with ZXC.

System:

	Zip Chip	Normal	% increase
1	58.5s	200.1s	342
2	59.8s	197.0s	329
3	61.8s	204.9s	332
4	48.5s	169.0s	349
5	65.0s	163.4s	251

Key to the systems :-

- 1) Apple //c with 576K Multi-RAM on board.
- 2) Apple //e with 256K Ram-Works on board.
- 3) Apple //e with 1Meg Ram-Works on board.
- 4) Apple //e with 1Meg Cirtech plusRAM on board.
- 5) Apple IIgs with 1Meg Cirtech plusRAM on board.

The above few examples show how well Zip Chip improves the speed of AppleWorks. Other tests carried out on database files etc. all show that there is a gain of better than 300% except where disk access is required. These tests were carried out solely to compare the speed differences between Zip Chip running at 4.0 megahertz and a normal Apple // computer. There was no intention to compare different systems against one-another and any such comparisons should be viewed with caution. Please note that the plusRAM card (manufactured by Cirtech (UK) Ltd.) and presumably other 'Apple-type' memory cards such as RAM Factor (manufactured by Applied Engineering - supplied in the UK by Bidmuthin Technologies) must be in a slot with fast access to achieve the results above. For instance slot 4, in default mode, is ok but slot 5 is not as access is at normal speed (1.023 megahertz). I tried the Zip Configurer so that slot 5 would be accessed at 'system' speed and then obtained the same results as above.

2) Merlin 8 assembler

(See Figure 5) The effect of the Zip Chip in the Apple //e and

Figure 5 - Merlin 8 Assembler

Merlin version	Processor	time to assemble
MERLIN 8	Apple //c and Apple //e Zip Chip	3.8 = 13,700 lines/min
MERLIN 8	Apple IIgs fast	5.6 = 9,000 lines/min
MERLIN 8	Apple IIgs slow	13.0 = 4,000 lines/min
MERLIN 16	Apple IIgs fast	4.2 = 12,000 lines/min

Figure 6

Standard Apple //	= 194.6 seconds	
with the Zip Chip	= 53.0 seconds	367% increase
with Speedemon	= 58.0 seconds	336% increase
Apple IIgs fast	= 78.2 seconds	249% increase

Figure 7

White : B(d7) K(e5) R(a4) B(e1) Black : K(d3) P(g3)

Standard Apple // computer	= 900 seconds
Zip chip	= 294 seconds an increase of 306%
Speedemon	= 395 seconds an increase of 228%

Apple //c is to give an overall 342% increase in speed, for Merlin 8 users. Merlin 8 is a very fast assembler anyway but is somewhat faster than Merlin 16 on an Apple IIgs when Zip Chip is installed.

3) Two machine code programs - one small the other large

Glen Bredon's Apple Pie program to calculate Pi to 1000 decimal places gives a good guide to the effect of the Zip Chip on small machine code programs (See Figure 6).

Colossus 4 was used to solve a four move chess problem by Dr. A Mandler published in Parallele 50 in 1950. Colossus 4 examined 488,815 positions in finding the key-move! (See Figure 7)

Glen Bredon's Pi calculator is a quite small, well written, program which probably runs almost totally in the Zip Chip's memory cache with only the minimum access to the Apple computer memory at normal speed. Note how close Zip Chip and Speedemon are to their respective ideals 400% and 350%. Compare this with Colossus 4 which is a large program spanning the whole 64K bytes of Apple // memory and also writes to the screen as it calculates. Zip Chip shows a very good 300% plus increase in

execution speed which is probably due to its better memory management and thus suffers much less than the Speedemon card.

4) Applesoft test programs

(See Figure 8) The first three simple test programs and others show that small Applesoft programs can expect at least 320% increase in speed of execution for calculations and string manipulation. String manipulation will always be marginally slower than calculations since strings are stored in memory under HIMEM whilst their pointers are stored just after the end of the Applesoft program.

The fourth test indicates that programs that write to the screen a lot will suffer degradation in speed, however, in a normal program such deterioration should be hardly noticeable. This example shows just about the worst case.

The fifth program shows that disk access proceeds at normal Apple speed and that there will be virtually no speed increase at all.

The sixth program is included to show the effect of badly designed rambling programs on the Zip Chip.

5) Apple Logo II

Tests with this program indi-

cated a better than 300% increase except where some disk access was involved. For example graph drawing showed better than 320% increase.

6) Games

The games that I tested seemed to be affected by the Zip Chip more than other programs with generally better than 340% was noted, with some increases as high as 375 per cent.

The above timings were all done with a stop-watch. Four timings were

done for each test with the first being discarded. These were repeated some days later in the same way. The deviations between the two sets of results were extremely small.

Zip Technology claim their product runs at 4.0 megahertz which is four times faster than the standard 1.023 megahertz 6502 and 65C02 microprocessors at the heart of Apple // computers. Why don't the results above reflect this? Firstly Zip Chip has to read, each different location it reads, at least once from the Apple's own memory at normal speed which means that a 400% increase in speed can never be completely attained. Reading and writing disks and other I/O will all be at normal speed leading further away from the ideal.

To get the best out of Zip Chip your programs, particularly machine code versions, should be as small and compact as possible or written so that as much of the executing code and data can be stored in the 8 Kilobytes of Zip Chip's cache as possible.

Compatibility with hardware products with the Zip Chip.

It has not been possible to try all hardware configurations with all Apple // systems but here is

Figure 8

Program	length#	Zip Chip	Normal	% increase
P1 10 FOR M = 0 TO 4999 50000 NEXT M	23	2.1	7.0	333
P2 10 FOR M = 0 TO 4999 30 A = SIN(30) 50000 NEXT M	35	40.5	143.3	354
P3 10 FOR M = 0 TO 4999 30 A\$ = LEFT\$("HELLO", 2) + "LLO" 50000 NEXT M	49	9.5	30.4	320
P4 10 FOR M = 0 TO 4999 30 PRINT "A"; 50000 NEXT M	33	7.0	16.7	239
P5 10 F\$ = "SCREEN, A\$2000, L\$2000" 20 PRINT CHR\$(4) "BSAVE" F\$	49	7.2	7.7	107
P6 10 FOR M = 0 TO 4999 ## 50000 NEXT M	22253	807.0	2248.0	278

Program lengths are in bytes

This program contains 100 lines of very long REMarks.

a list of those checked out :-

- 1) Snapshot II card in an Apple //e runs perfectly at all speeds.
- 2) Cirtech CP/M plus board in an enhanced Apple //e computer works at normal speed but will not work at the 'system' speed. This is of no matter, of course, since the speed of the 65C02 chip has very little influence on the speed of CP/M. It is the Speed of the Z80 chip that really matters.
- 3) Microsoft and Digitek Z80 cards were also tested and worked only at normal speed. The above remarks also apply here.
- 4) Glanmire clocks work well at normal speed but are not particularly compatible at 'system' speed. Perhaps a re-write of the driver might help.

Anybody willing to comment or have a go?

Compatibility of software with the Zip Chip

The biggest problem with software packages will almost certainly be due to 'Copy Protection'. So far, though, the Zip Chip appears to be compatible with more software for Apple // computers than was the Apple IIgs.

- 1) AppleWorks appears to be completely compatible including all the 'add-ons' that could be tried.
- 2) Applesoft also appears to be perfectly compatible.
- 3) Zardax version 5.2 wordprocessor, due to its copy protection, will not boot at 'system' speed. Boot up at normal speed and when the menu appears press the control and reset keys. This takes you to the other menu and forces the Zip Chip to its default configuration. Zardax just zips along after that.
- 4) Speedloader boots fine from its copy-protected diskette and runs very much faster because the application is Applesoft based and requires a lot of calculation. One problem may be noticed if you try to run a 'fast-boot' disk produced with Speedloader at normal speed as pressing the ESCape key causes it to fall into the monitor!! To prevent this happening press another key as you hear the beep. Speedloader is the utility, written by Cornelis Bongers and marketed by Apple 2000, that lets you create 'fast-boot' diskettes that can load data up to 16 Kilobytes per second and typically load an 8K Hires screen in just 0.6 seconds.

5) Older versions of diskettes copy-protected by the Protect-O-Disk system that would only boot on 6502 based machines will not boot with Zip Chip. Later versions will, however.

Of the hundreds of programs tested these are the only problems. Even those diskettes protected with some of the most bizarre copy-protection schemes boot-up just fine.

Look at the figures above and you will see that Zip Chip delivers a very respectable performance and you could expect an average of 320% increase for most applications.

Zip Chip technical information

The last ten pages of the manual provide technical details about the Zip Chip and its operation with sufficient information to enable programmers to configure it from within a running machine code program. The internal structure of the Zip Chip, taken from the manual, is

given in figure 9.

We will, of course, be continuing to carry out tests with other hardware and software products and will keep members informed by updates from time to time.

I would like to thank Roger Hulme for the loan of an Apple /c system and very large financial spreadsheets; William Watson for the use of Apple II plus systems and helpful advice; Nigel Bradley for the use of an Apple //e system; John Robertson of Cirtech (UK) for the loan of a Cirtech CP/M plus system for an Apple //e computer and a Speedemon card. Finally thanks to MGA Microsystems for providing the Zip Chip.

Zip Technology
11340 W Olympic Blvd.
Suite 350, Los Angeles
California CA 90064

Figure 9 - Zip Chip internal structure

65C02 Processor Chip (rated to 4.0 megahertz)
ZIP CHIP Gate Array circuitry
8k TAG Cache
8k DATA Cache
16.00 megahertz Clock

info

Product : Zip Chip
Maker : Zip Technology
Available from :

MGA Microsystems
Pear Tree
Appledore
Kent
TN26 2AR
© (0233) 83571

Price : £179.00 inc VAT

Value : 

Performance : 

Dave Ward



MGA SoftCat

ZIPCHIP™*

TELEPHONE: 0233 83571

We all know about speed-up cards, many of us probably own one of them. They claim to speed up things and under many circumstances do, but they require a slot, eat power and won't address any expanded memory. They are cumbersome, break down easily and are incompatible with a lot of software and hardware. Yet we buy them, because our favorite machine only runs at a very slow 1 megahertz, and we desperately need more speed.

A new microprocessor chip running much faster without affecting any of the other operating characteristics of the Apple II would solve the problem.

— WELL NOW IT'S HERE!!

The Zip Chip™ is the result of a couple hundred thousand dollars and two years of engineering effort to produce a replacement for the Apple II CPU; one that will provide the increase in speed needed to take the Apple II to the realm of an IBM PC/AT, yet allow total compatibility, and flexibility in software and hardware.

The Zip Chip™ requires no special tools or knowledge to install. The Zip Chip™ requires no special boot-up. Just turning on the Apple II, II+, IIe, IIc, or any Apple compatible, now creates a 4 megahertz environment, 400% faster.

APPLE II GS VERSION COMING SOON!



The ZIP CHIP™:

- Is transparent to all software.
- Is compatible with all hardware.
- Addresses 1.9 megabytes of memory.
- Has 16 variable speeds.
- Will never wear out or break down.
- Costs much less than any speed-up board.
- Carries a Lifetime Warranty.
- Speeds up all types of memory, Main, ROM, & AUX.
- Requires no slot.
- Requires very low power.
- Has no switches.
- Operates at 4 megahertz.
- Uses keyboard controlled speed changes.
- Is faster than any speed-up board.
- Only £179 inclusive

HERE'S HOW IT WORKS: Zip Chip contains a standard microprocessor, a unique gate array and a special RAM cache, which allows data and instructions to flow through at an accelerated rate without causing a jam-up. Since the normal speed of the 65C02 is only 1 megahertz, the ZIP Technology engineers replaced the normal clock with a 16 megahertz crystal and partitioned it such that the enhanced Zip Chip™ will operate at 4 megahertz, a four times increase in speed. AppleWorks just flies. Many applications show a better than 360% increase in throughput.

* patent pending



/PROCMD

Peter Davis gives us an Outline of the /PROCMD package (THE COMMANDER)

By Glen E. Bredon

Some months ago I had been asked to provide a PRODOS program under BASIC.SYSTEM, which amongst other rather painful requirements was supposed to enable the end user to FORMAT a 5.25" disc. This turned out to be rather longer search than at first expected.

There are a number of options which I tried, but each one in turn was found wanting. I bothered the Hotline more than I should, but in the end the answer came from Denis Doms of Open-Apple, who suggested that this package would contain what I wanted. To cut a long story short the package does contain this utility which works very well on 3.5" or 5.25" discs and like Glen Bredon's PROSEL, (reviewed by Dave Ward last month), there is an awful lot more.

This is not the first time this package has been reviewed, but Glen Bredon's policy of continuous development goes on making it better and more comprehensive, so that the present version V2.21 bears little relation to the first version reviewed in 1985.

It is available direct only (by international money order only, no cards) for \$25, postpaid in US and Canada, (foreign postage and handling \$5). The package consists of 2 disks which also contain a 50 page manual.

Glen E. Bredon
521 State Road
Princeton, NJ 08540
(609) 924-5976

How does it work?

The PROCMD disk contains a number of utility programs which are designed as "modules" appended to the ProDOS BASIC.SYSTEM interpreter. You

can add some or all of the modules to memory. This sets up new ProDOS commands which can be typed from the keyboard or invoked from a program.

By having these utilities in separate modules, you can load in only those which are of use to you at the moment and do not have to sacrifice valuable memory space to unwanted material.

However the simplest way one can load a module, say the FORMAT module, from the keyboard simply by typing :-

```
CLEAR (OR NEW)
BLOAD COMMANDS/
          FORMAT, TCMD, A$4000
CALL 4*4096
```

The first of these clears out variables to help ensure that the BLOAD command will not overwrite memory in use, the second loads the command module into memory, and the third executes a relocation routine which moves the module to its final destination and links it to any other modules already loaded.

Furthermore, you can review all the presently active commands simply by typing "&". You are then presented with list of modules with their appropriate syntax for use. In the case of FORMAT this would be:-

```
FORMAT volume.name, S#,D#
```

FORMAT allows optional slot and drive parameters and a default to 6,1. This command takes effect as soon as it is issued. It does not print any messages to the screen because that might interfere with the display of programs using the command. Standard error messages No device connected, Write protected, and I/O error (for eve-

rything else) can result and can be handled by the usual ONERR error handling of Applesoft.

Loading Modules

The easiest way to load modules is to use 1 of the 3 programs STARTUP a variant of the COMMANDER program or a short Binary routine CMDS which allows a new command to be added at any time during programming.

Other Programs are provided for easy for special purposes and demonstrations, here is a partial list which gives a flavour of the areas covered.

FITR is a file handling utility for batch copying, locking, unlocking, and deleting of selected files.

DEMO.SORT demonstrates the very versatile Array sort module.

MACRO.EDIT provides the means of editing a useful macro program writing aid.

FONT.EDIT provides the means of editing several fonts provided in 8 x 16.

The Command files are fully listed in **Figure 1**. As can be seen these Commands fulfill a number of functions. I have attempted to collate them under various heads:-

Utilities

Basic Editing and Program manipulation, Debugging Aids
Extensions to ProDOS Basic
Double High Resolution Graphics
HGR Modules
General Technical Information & Writing your own modules

The range is so extensive that I have chosen to break them down:

UTILITIES

Apart from FORMAT, there two routines to find the current ProDOS time in alternate formats (DATE & DATESTR), a CLOCK, and a means of determining devices ONLINE.

POP simply drops one or more levels of current PREFIX, while PATH can search a whole volume for a specified file, FIND will search a file or all files on a disc for a specific string and provides the address, EJECT handles the auto eject facility on 3.5 and Unidisc

drives, while COPY enables file copying without damaging a program in memory. LYST provides a formatted listing of part or all the program in memory, printing statements line by line, highlighting in different ways:- Control characters, FOR-NEXT loops, REM and FOR statements as well as providing pagination.

DUMP is a hex/ascii dump utility. It has two modes: memory dump and disc file dump. SET-INFO permits the changing of a files type or access in number of ways, to the extent that it would be impossible to LOAD or RE-NAME a BAS file by any normal means. HEXDEC module converts either way. COMPARE displays the difference between on file and another. COMPARE also contains a PASTE facility which will APPEND one file to the end of another.

BASIC EDITING AND PROGRAM MANIPULATION, DEBUGGING AIDS

The disc has a GPLE - like Editor (EDIT) complete with RE-NUMBER to give AUTO HOLD and MERGE commands as well as MACRO for faster entry. XREF will cross reference line numbers and variables, while VARLST dumps current variable values. VATRC is a debugging utility which transparently to the program traces current variables and their values at the top of the screen during program execution. ONEKEY will convert single key strokes A,R,L,E,M to AUTO, RENUMBER, LIST, LIST, EDIT and CALL-151. The POINTERS command prints out the values in hexadecimal of the following seven Applesoft pointers.

Start of:

- current BASIC program.
- variable storage (LOMEM).
- array variables.
- free space (space available to strings).

End of free space (bottom of current string storage).

Top of string storage (HIMEM).

Address of end of BASIC program.

Extensions TO ProDOS BASIC

USING is Print USING command enabling a variable to be presented within a template and by this means values can be

printed with or with leading zeros, include signs, commas. eg \$100,23.29. Similarly SCI permits the Scientific E format to converted to exponential format 1.01×10^{-6} . Similarly RDLINE enables the input formatting of a string variable. In addition it incorporates an "Input Almost Anything" command which also supports default entries, the underline curser and DELETE keys. The RDLINE module also contains an Ampersand command "&INPUT A\$" mainly intended for reading from an open disc file. The TYPE command will type out a TXT file with specification of page length, spacing, lines per page and pagination.

The SORT routine is most versatile. Its features are:

1. It is very fast, based on the "Quicksort" algorithm.
2. It will sort a string array alphabetically or numerically.
3. It will sort string arrays, real arrays or integer arrays.
4. It handles multidimensional arrays, sorting on any field.
5. It sorts multiple arrays (sorting one, others kept in line).
6. It will sort any range of an array.
7. String sorting is not case sensitive.
8. Empty string records are moved to the bottom.

DOUBLE HIGH RESOLUTION GRAPHICS

The modules HGR, DHGR, FILL, PRINT, MOUSE, RGB and HLOAD contain double high resolution graphics routines.

These modules are slightly different from the rest because (except for HLOAD and HSAVE) they work using "ampersand" commands instead of added ProDOS commands. The "&" listing of added commands does not show these commands.

THE HGR MODULE

The module HGR has routines for plotting points and lines in "color double high resolution" graphics. This double hires mode has a resolution of 140x192. (Each color dot comprises four pixels for a total of 560 pixels across.) The module also contains DHGR shape drawing routines in 560x192 resolution. The

module FILL contains a double high resolution color fill routine. PRINT is a double hires character generator. Actually it is somewhat of a cross between a character generator and a bit mapped drawing routine. The MOUSE module contains interrupt driven routines which allow the user to move objects around the double high resolution screen using the mouse. This is transparent to the BASIC program. The objects that can be moved are characters from a FONT file having the same format as for the PRINT module. These are initially placed on the screen by certain ampersand commands. The module accesses characters in the font by means of "logical object numbers". This allows assignment of the same character in the font to different logical numbers and hence to distinct screen objects. The logical numbers must be in the range 0-127 and number 0 designates the mouse cursor. (Thus, any character in the font can be designated as the cursor.) The "hot spot" is always the upper left corner of an object (extending somewhat below and to the right). HLOAD and HSAVE are used for loading and saving these images.

GENERAL

The Commands are created using Merlin-Pro. Each module is an even multiple of 256 Bytes Bloded to location \$4000 followed by the CALL 4*4096 which causes the command to be relocated at an ID byte determined from within the module itself. There is abundant technical information and advice on writing your own modules.

Conclusion

This is a very valuable package combining some of the features of Beagles Utility Programs as well as the Beagle Editor. All is very compact, and you do not seem to get conflicts as seems to happen with the Beagle Editor of the and WIZARDS TOOLBOX. (Though the Beagle Editor.LC still works in the presence of CMDS) Beagle compiler still works for AMPERSAND routines contained in the part of the package. I can only again echo, (plagiarise?). Dave Wards conclusion concerning PROSEL.

The /PROCMD package has

FIGURE 1: The /PROCMD Command files

File: cat.procmd
Page 1
Report: trans
Category 01

Filename	Blocks	Type	Modified	Created	Length	Subt
PRODOS	32	SYS	26-MAR-88	11-JAN-88	\$3C7D	\$0000
BASIC.SYSTEM	21	SYS	18-JUN-84	18-JUN-84	\$2800	\$2000
STARTUP	7	BAS	10-SEP-87	13-DEC-84	\$BF4	\$0801
FONT.EDIT	9	BAS	21-FEB-87	3-FEB-85	\$FFB	\$0801
MACRO.EDIT	8	BAS	13-APR-85	28-DEC-84	\$DBA	\$0801
FITR	10	BAS	13-SEP-87	24-JUL-85	\$1124	\$0801
COMMANDER	4	BAS	9-SEP-87	14-NOV-84	\$467	\$0801
COMMANDS	4	DIR	3-APR-88	21-SEP-85	\$800	\$0000
ONLINE	3	CMD	25-JUN-85	16-NOV-84	\$20A	\$4000
POINTERS	3	CMD	9-APR-85	16-NOV-84	\$22A	\$4000
TYPE	3	CMD	18-JUL-85	16-NOV-84	\$331	\$4000
DUMP	3	CMD	9-APR-85	16-NOV-84	\$308	\$4000
SORT	4	CMD	21-AUG-86	23-NOV-84	\$566	\$4000
VARLST	3	CMD	9-APR-85	28-NOV-84	\$331	\$4000
VARTRC	3	CMD	9-APR-85	29-NOV-84	\$35E	\$4000
DATE	3	CMD	9-APR-85	7-DEC-84	\$223	\$4000
USING	3	CMD	18-MAY-85	8-DEC-84	\$329	\$4000
COPY	3	CMD	5-SEP-85	15-DEC-84	\$31B	\$4000
RENUMBER	5	CMD	23-MAR-86	19-DEC-84	\$7D8	\$4000
XREF	4	CMD	12-APR-86	21-DEC-84	\$591	\$4000
FIND	3	CMD	9-APR-85	23-DEC-84	\$325	\$4000
EDIT	6	CMD	11-SEP-87	24-DEC-84	\$8CA	\$4000
MACRO	4	CMD	25-JUL-85	27-DEC-84	\$49E	\$4000
MACRO.2	4	CMD	25-JUL-85	24-JAN-85	\$4B6	\$4000
LYST	4	CMD	4-NOV-85	15-JAN-85	\$496	\$4000
HGR	4	CMD	5-MAR-86	17-JAN-85	\$496	\$4000
FILL	3	CMD	28-APR-86	29-JAN-85	\$343	\$4000
DHGR	3	CMD	9-APR-85	31-JAN-85	\$338	\$4000
PRINT	3	CMD	5-MAR-86	3-FEB-85	\$361	\$4000
HLOAD	4	CMD	1-APR-88	17-MAR-85	\$495	\$4000
CLOCK	4	CMD	9-APR-85	24-MAR-85	\$4C5	\$4000
CLOCK.24	4	CMD	12-JUN-85	12-JUN-85	\$4A8	\$4000
CLOCKE.12	4	CMD	10-JUN-85	10-JUN-85	\$546	\$4000
CLOCKE.24	4	CMD	10-JUN-85	10-JUN-85	\$529	\$4000
HEXDEC	3	CMD	24-JUN-85	7-JUN-85	\$21D	\$4000
ONEKEY	3	CMD	25-JUN-85	7-JUN-85	\$21E	\$4000
POP	1	CMD	7-JUN-85	7-JUN-85	\$1D6	\$4000
MOUSE	6	CMD	17-SEP-86	14-JUN-85	\$878	\$4000
SCI	3	CMD	27-AUG-85	26-AUG-85	\$21E	\$4000
DATESTR	3	CMD	1-JAN-88	2-FEB-86	\$345	\$4000
RGB	3	CMD	6-MAR-86	5-MAR-86	\$24C	\$4000
EJECT	3	CMD	15-MAY-87	1-MAY-86	\$236	\$4000
CMDS	3	BIN	17-JAN-87	15-JAN-87	\$38A	A=\$4000
SETINFO	1	CMD	18-JAN-87	16-JAN-87	\$1F4	\$4000
PATH	3	CMD	17-JAN-87	17-JAN-87	\$37E	\$4000
COMPARE	5	CMD	10-DEC-87	12-FEB-87	\$689	\$4000
RDLINE	4	CMD	15-SEP-87	21-FEB-87	\$5E2	\$4000
FORMAT	7	CMD	3-APR-88	24-JAN-88	\$A9D	\$4000
FONTS	1	DIR	21-SEP-85	21-SEP-85	\$200	\$0000
GOthic	9	BIN	7-MAR-85	1-MAR-85	\$F4D	A=\$4000
ROMAN	7	BIN	5-MAR-85	3-MAR-85	\$AAF	A=\$4000
ITALIC	7	BIN	7-MAR-85	6-MAR-85	\$AC5	A=\$4000
DICE	1	BIN	21-MAR-85	21-MAR-85	\$1AD	A=\$4000

Blocks free: 11 Blocks used: 269 Total blocks: 280
Number of standard files: 51 Number of subdirectories: 2

been written by a perfectionist for his own use, and we are fortunate to have such comprehensive package available at such a modest price.

PRICE \$25, postpaid in US and Canada. (foreign postage and handling \$5 by international money order only, no cards)

FROM Glen Bredon
521 State Road
Princeton, NJ 08540
(609) 924-5976

PETER DAVIS



info

Product: /PROCMD
Author: Glen E. Bredon
Available from:

Glen E. Bredon
521 State Road
Princeton
NJ 08540
Tel. (609) 924-5976

Price: (USA) \$25.00
\$5.00 postage

Value: ★★★★★
Performance: ★★★★★
Documentation: ★★★★

Apple II Product News

New Products from MGA Softcat

SUBLOGIC 3-D graphics packages are now available again. The AB-3D1 "Basic 3D Graphics" pack costs just \$38.00, and the more extensive "Graphics Family" costs \$97.95. The Graphics Family package is actually comprised of three distinct programs - A2-3D1 Graphics Package, A2-3D2 Enhancement, together with the A2-GE1 Graphics Editor.

DISC COMMANDER by So What Software is a disk editing system for the Apple II family of computers using DOS 3.3 or DOS 3.3 with PRONTO-DOS enhancement. Disc Commander costs \$27.95

ICONIX by So What Software for the Apple IIgs is the key to unlock the Super Hi_res capability of your Apple IIgs. Run under Basic and ProDOS 8, Iconix allows manipulation of the improved Graphics of the IIgs. Iconix-GS costs \$37.95 Iconix-2 for the Apple II costs \$27.95

MGA SoftCat are now selling the APW Programmers Workshop from Apple. Previously only available from the specialist developer groups, APW allows programming under the ProDOS 16 environment and toolboxes of the IIgs. APW Workshop V1.0.1 by Apple Computer \$97.95

Also for the IIgs is the APPLE IIgs BASIC. A full implementation of extended Microsoft basic with access to Toolbox routines through library units. Apple IIgs Basic by Apple Computer \$57.95

MGA SoftCat are also issuing the new IIgs System disc V3.2 at \$17.95

All prices include VAT

Contact:
MGA Microsystems
Peartree
Appledore
Kent
TN26 2AR
023 383 571



The GS Juke Box

Ensoniq Input Interface for the Apple IIGS - John Kishimoto tells us how to record our own music on the GS ...

The Ensoniq

History has it that the original sound chip envisaged for the IIGS was to be a standard arcade quality type, commonly seen on other well known home computers. It was only through the persistence of an Apple II group engineer Bob Moore and engineering manager Dan Hillman that the Ensoniq was accepted as the sound generator for the GS.

The IIGS is the first personal micro to use a sound chip used in a commercial music synthesizer. The Ensoniq 5503 Digital Oscillator Chip (DOC), as used in the Mirage synthesizer, is a programmable sound chip with 32 oscillators, volume control and built in Analog to Digital (A/D) converter. In general use, the DOC is capable of generating 15 channels of sound, and digitising input sound, volume control, and other registers.

This article is restricted to the hardware designed and constructed for use with the onboard 8 bit A/D converter.

Hardware

The A/D is a successive-approximation converter with a conversion time of 31 microseconds. It requires a maximum peak to peak signal of 2.5v and has an input impedance of 3,000 Ohms. Any circuit satisfying these requirements should be capable of being used as an input device to the DOC.

Fig.1 shows the circuit diagram of the board. The input to the circuit (which uses a TL071PC Op-Amp) has to be of 300mv amplitude or less, a capacitor ensures that the input is high impedance. The gain, controlled by R4, allows for full scale conversion for a 300mv input. So if the

output from the tape recorder/amplifier is less than that (typically 100mv from a 'Line Out' socket), the resolution is proportionately lower. The output from the amplifier (pin 6) is then offset by resistors R5 and R6 by about 1.25v, ensuring that the voltage of the waveform being input to the DOC remains within its tolerance (0-2.5v).

Although the circuit has a fixed gain, it can be easily modified for different input requirements or connections to alternative devices. With access to an oscilloscope and signal generator, R2 and R3 can be replaced by a 220 K preset potentiometer (as a potential divider), the gain R4 with a 100 K preset, and the offset R5, R6 with a 220 K preset. By feeding signals of required amplitude into the circuit and examining the output, an appropriate combination of resistor values can be determined.

The prototype was constructed on a small Vero stripboard (1" by 2.5") with wires leading to a molex connector for input to the DOC, an 18 pin DIL plug for the supply, and a coax lead with an "Phono" type plug for the input.

The circuit board was physically attached to the molex connector making it self supporting. Supply to the circuit was via the DIL plug mounted on the internal games port connector. The lead to the recorder/amplifier was fed out through one of the pop out panels at the rear of the computer.

Total component cost for the project was under £4.00.

Software

Instead of writing software specially for the circuit, it was decided that two Public Domain packages "TAPEDECK" and

"SOUND STUDIO" should be used instead. Both packages have been written to make use of digitised sound, although only TapeDeck can be used for the actual recording.

TapeDeck was obviously designed primarily for use with a slot based digitiser. Since this circuit isn't slot based, but rather feeds its signal directly into the DOC, the 'IIGS Rec' radio button has to be selected for recording to take place.

The quality of the recording ultimately depends upon the source being used. With a radio/cassette "LINE OUT" connected to the circuit, the quality of the recording can be classed as very good, although the small speaker of the computer leaves a lot to be desired. With 1Mb of expanded memory, and slow sampling rate, it is just possible to obtain 1.5 mins of recording.

Conclusion

This amplifier was built to take advantage of some of the features of the Ensoniq sound synthesizer built into the GS. With its low cost and simple design, it should be possible for most GS owners to explore the sound potential of their computers.

Bibliography

- The Apple IIGS Book
Jeanne DuPrau & Molly Tyson
Bantam Books
- How to Use Op Amps
E.A.Parr
Bernard Babani Ltd.
- Apple IIGS Technical Reference
Michael Fischer
McGraw Hill
- Apple IIGS Hardware Reference
Apple Computer
Addison-Wesley

K. John Kishimoto



Both "TAPEDECK" and "SOUND-STUDIO" are available from Apple2000, either on TABBS for downloading, or from the Apple2000 GS library on disc 2GS003.

Parts are available from MAPLIN ELECTRONIC SUPPLIES Ltd. P.O. Box 3, Rayleigh, Essex, SS6 8LR (0702) 554155.

The Boffin answers your Problems

618 Valley Road
Mendley on Thames
Oxon
OX16 1BB.

Dear Boffin,

I have recently purchased a second hand PRISM modem 1000. I am using an Apple III with the modem operating at V23 Full Duplex, 8 bit odd parity and one stop. The software used is Access III.

Having dialed the TABBS number, the indicators showed I had a carrier, but the screen remained blank or an Open Apple appeared in the top left hand of the screen. The line then went dead.

To put it in a nutshell ... HELP

R B Toomey

I have answered your letter directly but am publishing some of my answer and an extra point or two.

First of all, I think I am right in saying that the Prism 1000 modem will only work with systems that support 1200/75 baud. This is fine as far as TABBS or BT systems like Gold or Prestel are concerned. TABBS cycles through the possible baud rates on a 4 second cycle. It will take about 20 seconds plus before it would see and lock onto your modem, you should wait for that to happen before you give up. I note that you got a carrier detect, but that the line went dead. TABBS will drop the line if no input is received from you within about 5 minutes.

I notice that you are set to 8 bits odd parity plus one stop. This may be a problem, as the usual setting is 8 no parity plus one stop.

However, there may well be a more fundamental problem. I am assuming that the Prism 1000 must be talked to at 1200/75 baud. That is you talk to it at the slow speed of 75 baud, and it talks back at 1200 baud. Some of the more expensive modems available these days will 'speed buffer' which simple means you can talk and listen at 1200 baud both ways. The modem then buffers or slows the send rate down to 75 baud for you.

None of the Apple serial cards or ports on any of the machines are capable of talking at 'split' baud rates, they can only support baud rates that are the same both ways. There are no 'split' baud rates available in the States, so no support from the machines is expected in software from the States. European programs that allow you to use split baud rates, usually do this by programming the serial cards in a special way. However I am sure that Access ///, being an Apple program will not be able to do this. The Apple Super Serial Card and the CCS7710 cards can all be controlled by software to produce split rates.

However, we then come across another fundamental problem. The Apple /// does not support interrupts from the serial ports. This means that many communications programs, will not work on the ///. They require interrupts to be available to flag incoming data as being ready.

I assume that Access /// knows all of this, and so will work correctly with Apple Serial Cards. However, I would not expect it to be able to handle split baud rates. As I assume also the Prism cannot handle speed buffering, then the data you are sending to the modem at 1200, will simply make nonsense as the modem sends it at 75 baud. The symptoms would be nothing at all on the screen as you have witnessed. I would have expected some message to have appeared though, as the receive side of things should have worked.

I fear that the Prism may well be of no use to you on

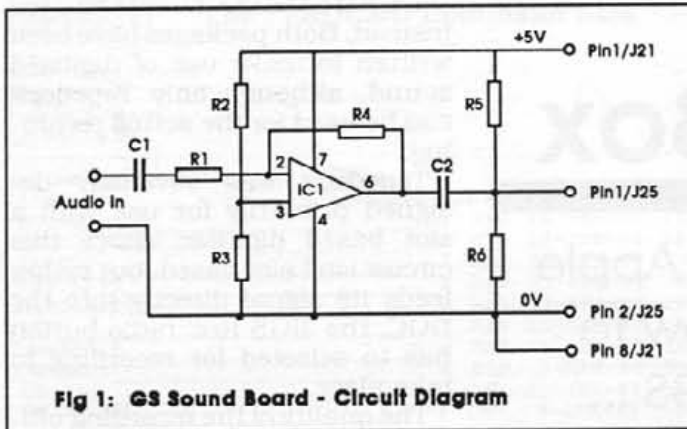

Fig 1: GS Sound Board - Circuit Diagram

PARTS LIST:

R1	10K
R2,R3	120K
R4	82K
R5	150K
R6	56K
IC1	TL071PC
C1	4.7uF
C2	4.7uF

CONNECTORS:

J21	Internal Game I/O	16 Pin DIL Plug
J25	Internal Sound I/O	7 Pin Molex Socket

Free for all

Open-Apple is Tom Weishaar's monthly newsletter for knowledgeable Apple II users. It's thin but packed tight with Apple II lore, humor, letters, tips, advice, and solutions to your problems. Compared to other Apple II publications, **Open-Apple** has the highest new-idea-per-issue ratio, the clearest writing, the funniest cartoons, the longest index, the best warranty (all your money back if you're not satisfied), and it takes up the least shelf space.

ll cue #55

The Apple IIgs has a shortage of usable slots, so it's best not to waste one of the standard slots on a RAMdisk. But any RAMdisk you create in the IIgs memory expansion slot takes RAM away from the system. One solution is to get a big RAM card. The biggest available is Cirtech's plusRAM GS6. This card will expand to the full 8 megabytes that the IIgs supports. For more, see the April 1988 **Open-Apple**, page 4.21.

From our fan mail:

I have started re-reading **Open-Apple** once more from issue No. 1, and I am once again mesmerised by the amount of information in such a small space. The more I read the more gets through to me, and if I search carefully enough, I usually find answers to my problems. In addition, it is a pleasure to read a magazine written in literate English. I am also amazed that the paper arrives so promptly each month in Israel.

L.D. Easternman
Ra'anana, Israel

Open-Apple

POB 765 L, Overland Park, KS 66207

Try two months free!

Offer good one time only. Try **Open-Apple** at our expense. Cut out or photocopy this coupon and mail it to us for a free two-month trial subscription.

Ad code: M283

Free airmail worldwide.

the Apple ///. You will need either a modem that supports 300/300 baud which should not cause any problems, or a speed buffered modem to handle 1200/75 by talking to it at 1200/1200.

Refer to previous letters and the various articles in Apple2000 if you decide to choose another modem.

The Boffin



36 ~~hurrymore~~ Road
Waverham
Northwich
Cheshire
CW9 5LF

Dear Boffin,

I have just received the August issue and must say that the magazine is getting better by the issue! I have the following tip for your reader who has problems with a II+ and UHF modulator:

I used to own a US II+. I purchased a PAL card for Slot 7, but still could not get anything on the TV screen. The solution turned out to be that two pins on opposite sides of the motherboard had to be connected by soldering a wire to them (I am not talking about the jumper pads). This was done for me by Pete and Pam Micros back in 1981. The result was PAL colour output on my telly.

I have an unenhanced //e, STAR DP510 (Gemini) printer and Grappler+ Interface card. When trying to print using AppleWorks, the output comes out garbled. If I try to print the same document again, it is garbled in exactly the same way. I therefore concluded that the problem lies with AppleWorks. Is there a simple patch?

I am getting some funny behavior when using the extended 80 column card as a Ram disk in CP/M. Occasionally, the least significant bit of a byte appears to be dropped. Does the //e's inbuilt RAM checking firmware also check the extended 80 column RAM? If not, how can I check that this RAM is OK?

You include a booklist with the August issue of the magazine. A couple of the books may be of interest, but there is no synopsis of their content. Can you please tell me what they contain: Expanding and Maintaining your Apple Computer; Apple Numerics manual.

Hope that you can help me out. Keep up the good work.

Bill Hill

□ Thanks for the tip on the modulator. The problem here is that there have been various 'mods' to the basic Apple II motherboard. In the beginning all slots were equal, then came the need to provide extra signals for PAL colour and other boards. Slot 7 was chosen for this, and the later machines actually came with Slot 7 sealed by a strip warning that it should only be used for Colour Boards. Pins 23-24 and 27-28 were used originally to link DMA and INT signals through cards to provide a priority level to the slots. On Slot 7, 23-24 were used to carry video signals. If your machine is an early model, you need to have these pins linked to the correct video signals.

As a follow on from this, you must be careful if you put any cards other than colour cards into Slot 7. Most cards have Pins 23-24 linked through to 28-27 on the opposite side. You may need to break these links in order not to confuse other cards with video signals!

I am not sure of your AppleWorks printing problem, but suspect that you may need to send an Initialising string to your card, in order that the Grappler passes the correct data to the printer. Check in your printer manual and AppleWorks manual for fuller details.

I do not think the RAM check of the //e checks the extended RAM. It sounds very much however as if you do have a faulty chip.

A solution for everyone . . .

We offer the full range of Apple II and Macintosh 512K, Plus, SE and II computers, accessories and software from individual items to sophisticated systems for the latest applications in desk top publishing or computer aided design at competitive prices.

Whatever your interests as a newcomer, enthusiast, professional, small business or large public company, we can provide new and used equipment, with excellent service, reliability and after-sales maintenance, training and support.

With such a wide range of Apple Macintosh equipment and applications, why not call us to discuss your requirements.

ROGER D'ARCY COMPUTERS

Tel.: Oxford (0865) 728787



Finally! A Keyboard Protector That:

- **PROTECTS CONTINUOUSLY - 24 HOURS A DAY** - Against computer downtime due to liquid spills, dust, ashes, staples, paper clips and other environmental hazards.
- **REMAINS IN PLACE** during the operation of your keyboard. SafeSkin is precision molded to fit each key - like a "second skin."
- **EXCELLENT FEEL** - The unique design eliminates any interference between adjacent keys, allowing smooth natural operation of your keyboard.
- **SafeSkin IS VIRTUALLY TRANSPARENT** - Keytops and side markings are clearly visible. In fact, SafeSkin is so clear, sometimes you may not know it's there!
- **DURABLE - LONG LASTING** - SafeSkin is not a "throw-away" item. Many of our protectors have lasted over 3 years under continuous daily use, without failure.

SafeSkin is available for most popular PC's and portables including: **APPLE II, II+, IIe, IIc, GS, MAC, MAC+ and MAC SE.** Specify computer make and model.

MGA SoftCat

TELEPHONE: 0233 83571

from
£24.95
incl

You will see on your 80 column card that you have a row of 8 identical RAM chips. One for each bit of the byte. Try changing these around, and it should cause the faulty bit to move within the byte. Change again, and a bit of deduction should show which is the faulty chip. These are all standard 64K RAM chips and should be easily obtainable from Maplins or any electronic dealer.

We are now stocking a range of books for the Apple Computer. Most of these are actually the official manuals released by Apple through Addison-Wesley. The Numerics manual you mention, is a rather specialised book. It deals with the SANE or Special Apple Numerics Environment, that lies deep within the Toolbox of the Macintosh or the IIGs. I do not recommend it for the light reader, it is very specialised and deals with the calls used for handling floating point arithmetic within these two environments. The other book you mention, is not one of the Apple books, and I do not know what it contains ... any one out there able to help?

The Boffin

Wardle Cottages
 Currie Road
 Selkirk
 TD1 2BP
 Scotland
 Tel: 01896 57790

Dear Boffin,

My latest problem concerns an Apple II+. Do you know of an 80 column card which supports Upper and Lower Case, Inverse and a text window in Applesoft?

Brian Gooch

□ There is no card that directly supports what you ask. The problem lies in Applesoft itself. The version on your II+ was never intended to handle Upper and Lower case. The Applesoft on a //e, //c or IIGs has been modified to cope with the extended display of these machines.

Most cards accept character input through an interface that handles Upper and Lower case information, but needs special codes to switch on Inverse display. Although Applesoft will not generate this information directly, you can of course use Applesoft to print it all to the

screen. It is only a matter of getting the right information into the program strings.

The Videx 80 column card, second hand or as a 'clone', will allow both Inverse and text windows to be displayed.

The Boffin

Quay Cottages
 Ferry Road
 Tappin
 Devon
 EX24 0JJ

Dear Boffin,

I am a new member of Apple2000, and I am interested in learning about and joining the FORCE as well as using TABBS. I own a MacPlus. Could you advise me on what sort of modem is required, and a suitable make (and if possible, a reliable supplier).

Marc Millon

□ Briefly, you are fine with what you have. You must add a modem, and I would recommend the PACE Linnet 1200 supplied by Apple2000. You might like to get Red Ryder from our Macintosh library.

Ewen Wannop

Introducing PlusDisk SC the first completely electronic disk drive for the Macintosh

PlusDisk SC is a major leap forward in storage technology. It combines the lightning-fast performance of an internal RAMDisk with the permanent storage and convenience of a Hard Disk. Unlike a RAMDisk, PlusDisk SC doesn't use any precious internal memory. Unlike a Hard Disk, PlusDisk SC has no moving parts or noisy fans and consumes virtually no power (it uses a small mains power pack when in use). PlusDisk SC easily outperforms all other disk drives (PlusDisk has an access time of ZERO Milliseconds compared with 70 Milliseconds for the average Hard Disk drive)! PlusDisk SC is 100% compatible with ALL Mac software and SCSI utilities.

PlusDisk SC totally eliminates disk delay frustration forever! Starting up applications takes only a fraction of the normal time (eg Excel or Word in under 5 seconds). Quit any application to the desktop in less than 1 second! Because the Mac spends a large amount of time on disk-based operations, PlusDisk accelerates total system performance to a higher level.

PlusDisk SC connects straight onto the SCSI port on any MacPlus, SE or II. It comes complete with 1 Megabyte and can be expanded at any time, using plug-in 256K modules, right up to 4 Megabytes.

PlusDisk SC has an inbuilt power source to maintain your data in special fast access, low-power RAM chips for ultimate reliability and superior performance. The power source is recharged automatically when you use PlusDisk. Even if PlusDisk is not in use or plugged in at the mains, its contents are fully protected for a minimum of 3 months, effectively making it a permanent storage device!

ADD THE LIGHTNING TOUCH TO YOUR MAC WITH PLUSDISK SC
 from £348.00

Available from your Mac dealer or direct



CIRTECH (UK) Limited, Currie Road Industrial Estate, Galashiels, Selkirkshire, TD1 2BP, Scotland
 Telephone: (0896) 57790 Telex: 265871 (MONREF G) ATTN: 84: CPD 001 (Telecom Gold)

(Prices exclude VAT)



Lolly Sticks and 'Lastic Bands

Jim Harle issues a challenge to AppleWriter Users unfamiliar with WPL

Some dice with death by jumping from aircraft flying at thousands of feet, relying on being attached to an overgrown tablecloth by bits of string. Others get their thrills from hurling themselves while inches from the ground at incredible speeds round a race track in high-powered motorised sardine cans. I live dangerously whenever I use the lolly stick modification on my //e.

Three modifications distinguish my unenhanced //e from the common herd. There is the little switch under the front of the keyboard which used to toggle between hash and pound on the display. Wires from that now lead to a printer card to toggle conveniently between printing under DOS3.3 and ProDOS. Then again, the 6502B has been replaced with a 65C02 to give me those extra commands when working in machine code. Lastly come the two lolly sticks.

This unusual device is several years old but was upgraded about twelve months ago. In its primitive state, one of the sticks was stuck to the machine by sellotape. It now pivots on a little bolt so that it merely swivels away, no longer having to be peeled off and leaving exposed acres of fly paper which never had a real home. In use, this stick protrudes from beneath the open-apple key. The second lolly stick rests upon it and is bound to it by a couple of elastic bands just tightly enough to keep the above mentioned key depressed by one end. Downward pressure on the other end releases open-apple.

I have a vague suspicion that a wired switch connected to

some socket at the back of the machine might achieve the same end more simply. If that is so, perhaps some knowledgeable member will submit the practical details to this excellent journal for our edification.

Now here is a strange and exciting thing. The open-apple-lock described enables a succession of mini-WPL programs contained in a glossary to be run by single keystrokes. The power of this tool has to be seen to be believed, but the components are all there in AppleWriter // and sadly overlooked by many Apple // users. It so happens that the way to quit a WPL program and return to the AppleWriter text editor is by using control-reset. A glimpse of the danger lurking in the lolly stick modification may now flash across the mind. A short lapse of concentration, and

Hidden Assets

Now let us leave the more sophisticated and get down to brass tacks. The truth is that AppleWriter // has a very powerful language built-in which few of us use, viz. Word Processing Language (WPL). Admittedly, I only joined Apple 2000 a couple of years ago, but so far I haven't noticed anything about WPL in the magazine. For that matter, I have yet to meet a fellow WPL programmer, but I'm sure they must exist somewhere out there. The language is just too good for everyone to pass it by without perceiving its potential.

I've been pondering on the lack of interest and material, and wonder if communication difficulties might lie in the

listing of WPL programs. After all, some lines may be quite long, while many others might consist of only the odd character or two. The general appearance is long and straggly, and hardly suits the columns of a magazine. The language itself has a relatively small number of commands and fairly simple syntax, and after discovering it I soon found myself fluently writing programs which handled text and files with consummate ease in the friendliest of computer environments. If you use AppleWriter // and have ignored WPL, I wonder if a challenge will whet your appetite.

The Exercise

I remember my son spending hours typing Basic programs from magazines into his succession of computers (models that don't keep as well as Apples!) which eventually led him to write his own programs at will through a growing awareness of that language. Perhaps a similar exercise may stimulate interest in WPL. So from my vast treasure chest of home produce, I offer the little program called "count" (a Cox's Orange Pippin?). To make this a real test of wits, the program has been disguised in such a fashion as makes it more acceptable to a magazine's format. (It uses 33 columns besides the "Len:" tally figures.) Can you correctly interpret the rules and accurately type it into your machine?

To test your results you will need to know a little bit about WPL, and the following points are worth noting.

(i) There is no difference between a WPL program and any other AppleWriter text. It is created, edited and saved with a filename perfectly normally.

(ii) A program needs to be saved to disk before it can be run.

(iii) To run a program under ProDOS, set the prefix to its directory and type [P]dofilename followed by a RETURN, or without the prefix being set, type [P]do/pathname followed by a RETURN. [P] stands for control-P.

(iv) To run a program under DOS3.3 saved on the disk in slot

X and drive Y, type [P]dofilename,sX,dY followed by a RETURN.

Please note that AppleWriter is perfectly happy to try to run a letter to your M.P. as a WPL program if you ask it to do so with [P]do but it will soon spot the difference in format!

Count Your Blessings

It also helps to know what "count" is supposed to do and how it is used. This harmless little program operates on whatever is in the memory when it is called, without altering the memory in any way. It counts the number of times a character of your choice appears in memory up to the usual maximum of 65535 and then asks if you've had enough. If you choose to count nothings, the program responds with the number of lines in your document ignoring word wraparound. It is not usually thrown by control characters or groups of less than 64 characters, though results will be invalid if < > ? or = are involved other than singly and in isolation. If you have knowledge of delimiters and of the way the program works, three of these characters may be used to advantage. Spaces by themselves can be counted under DOS3.3 but not under ProDOS. You can exit the program at any stage with impunity using control-reset assuming, of course, the absence of an open-apple-lock.

To help start you off on the right foot, the program begins:

```

_____ < Data Line >
PGOe
a F<$A<$A<
Y?
PGOb
PRT
b PSX+1
PGOa

```

and don't forget to save it to disk before you attempt to [P]do it. If all else fails, "count" is available on TABBS.

TYPING RULES for EXPANDING CONDENSED WPL PROGRAM

The square bracket convention is used to denote control characters, i.e. control-G appears as

THE "count" PROGRAM in WPL CONDENSED LISTING FORMAT

```

count JHHarle 880725'
+ PGOe+a F<$A<$A< Y?+ PGOB+ PRT+ 32
+b PSX++1+ PGOa+c F/$A/$A/+ Y? + 61
+ PGOD+ PRT+d PSX++1+ PGOc+e PND+ 92
+ PPR[L]+ PPR<CR> only counts lin
es.+ PIN[G]Count occurrences of w
hat? :=$A+ PSX0+ B+ PCS/$A/</ + 183
+ PGOi+ PCS/$A/>/+ PGOi + 206
+ PCS/$A/?/+ PGOi+ PCS/$A/=/ + 234
+ PGOi+ PCS/$A//+ PAS>=$A+ PSRa + 265
+ PCS/$A/>/+ PGOh+f PPR + 288
+ PPRThere are (X)+ PPR + 311
+g PIN[G]"count" again? (y/n):=$A
+ B+ PCS/$A/y/+ PGOe+ PCS/$A/Y/ + 373
+ PGOe+ PCS/$A/n/+ PQT + 395
+ PCS/$A/N/+ PQT+ PPR[L]+ PGOg + 423
+h PSX++1+ PPR+ PPR(X) lines + 450
+ PPR+ PGOg+i PCS!$A!/+ PGOj + 479
+ PSRc+ PGOf+j PSRa+ PGOf+count 509

```

[G] and is typed control-V control-G control-V to enter it in an AppleWriter text file. Keeping to these rules, type the program exactly as it is shown, observing capitals and lower case which are sometimes critical. Take care to distinguish l, 1 and I; 0 and O; etc. The program does not end with a RETURN.

(a) Don't type the top line (the heading), or the plus beginning the first line of the program. Note that many programs begin with a space, as do most lines.

(b) Ignore pluses at the beginning of a line unless the preceding line does not end with one.

(c) A pair of pluses is typed as a single plus.

(d) All other single pluses are typed as a RETURN.

(e) Ignore any space(s) occurring immediately before any plus at the end of a line, but type all others.

(f) The numbers at the end of the lines should tally with the "Len:" value shown on the AppleWriter Data Line after the RETURN (if required) has been typed.

The author would value observations, suggestions, queries and constructive criticism based on the subject of this article. Feedback through Apple 2000, please, including any tales of success.

Jim Harle

The BOFFIN answers ...

1 Wesson House
Ashburton Road
Croydon
Surrey CR0 6AQ

Dear Boffin,

I have just bought a Hohner 150 MIDI keyboard, I have an Apple //c.

I would like to connect these together so that I can write music on the Apple screen, and store it, then play on the Hohner. It would also be nice to be able to play the keyboard and have the notes appear on the screen.

Please can you tell me if there is any hardware and software available which would do any of what I want?

G Gardener

Apple have just released a MIDI box for the IIs. I have not actually seen inside it, but it appears to be simply a small box with three connectors. Two of these are standard MIDI 5 pin DIN sockets, and the third is a small 8 pin MINI DIN to match the IIs serial port. I would assume that a cable connecting to the serial port on the //c would work just as well.

However, that is only a very small part of your problem. You need rather specialised software to do what you ask. I know of nothing that will run on the //c to do this. We are now seeing software for the IIs that can do this, but then the IIs was designed with music in mind by including a sophisticated sound synthesiser chip.

Can any one out there help with this problem ... The Boffin

The EPROM WRITER

Martin Randall looks at the Eprom Writer card

The Eprom Writer itself is a 145 x 180mm card consisting of 8 IC's, 11 resistors, 10 capacitors, 3 diodes (1 LED), 1 transistor, 1 DIL switch, 1 spst switch and a 'TEXTTOOL' IC holder. It is compact and well built and circuit-wise is basically a parallel-to-serial convertor with some buffers and circuitry to generate the correct voltages to program the EPROM's.

The instructions consist of 6-pages of single-sided sheet, which at first, looks quite impressive, or at least adequate until you start to read them.

Page 2 consists of the basic operation and setting-up. The writer can only program 3 device types :-

- A) 2716
- B) 2732
- C) 2764

This is probably adequate for most people although it would have been nice to see a more flexible programmer for the price. The instructions advise you not to install the card in slot zero, but to use any other slot. I tried slot 2. Remembering to turn-off the Apple, earth yourself via the power supply case to eradicate any static, set the DIP switch for the first device to test. This was a 2716. After pushing the card firmly home into slot 2, you then use PR#2 to call the card up.

The message then appears :-

'AP-64 EPROM PROGRAMMER ENHANCED
VELCOM WRITTEN BY CARL.'

- 2) 2716
- 4) 2732
- 8) 2764
- ?

All you have to do is confirm that the DIP switch setting is the same as EPROM you are going to 'burn'. Once this is done then you will be asked whether you wish to write, read, copy, compare, blankcheck or go to monitor.

My next problem (and criticism) now reared it's head. Having a full (bar slot#2) I/O section, there was insufficient room to install the ROM/PROM/EPROM master without either bending the card or possibly dropping the master IC. I decided to turn-off and remove cards 3 (80-column) and 4 RAM for safety.

100 MEG MAC SE



£2995.00 + VAT

Technical Specification:

Mac SE fitted with 3.5" 100Mb internal SCSI drive.
Drive Type: PRO SE100i
Manufacturer: CMS inc.
Capacity 100Mb formatted
Average Access Time 25ms
Auto park/lock at power down
Reliability: 20,000 hrs MTBF

Upgrades to 100 Mb for existing Mac SE's are also available.
SCSI drives available to 1.2 Gigabytes for Macintosh computers.
CMS drives for Apple computers are distributed by Bidmuthin Technologies.

Bidmuthin Technologies Ltd.
Brent House
214 Kenton Road
Harrow
Middlesex HA3 8BT

Telephone 01-907 8516

Authorised Apple Dealers
Level 1 Service Centre

Bidmuthin Technologies
The Apple Enhancement Experts

My next criticism was the inadequate directions for installing the master. Although it went to great lengths explaining the difference between the sizes, it failed to mention orientation of the device.

I decided to use the blankcheck to confirm that the EPROM's were blank. If this is successful, it comes up with 'ROM CHECK OK!' If not 'ROM CHECK ERR!!'.

Going back I tried to read the master into RAM. This appeared to be successful. All you need is the start address in HEX.

I then inserted a blank EPROM. After inserting the start address of the program in hex, you are then asked to confirm that a blank is installed, which is then checked. You are then asked to set the switch to on (LED comes on) and hit return. After about a minute and a half 'COMPARE OK!' comes up if the device is OK, if not an error message is displayed. You are then asked to 'SWITCH OFF' and can remove the EPROM.

Copy is a combined 'READ' and 'WRITE' and to all intents and purposes, there is no difference. I'm not sure why it is there really.

Beyond that, there is very little left to say except go over the hardware and documentation criticisms.

On the documentation side, the main criticisms are :-

A) No picture/plan to show correct orientation of the ROM/EPROM.

B) Para B on page 4 states that 'Sometimes you only want to correct data that (is) already programmed in the EPROM'. This is incorrect and it states this is impossible in the previous paragraph (which is true). It does after all, have to be erased by UV before you can try again.

On the hardware side. The main criticism's were :-

A) That out of the 15 devices that I tried :-

1) 3 were declared having data on them but when I checked them back on commercial programmers, they were blank.

2) 6 failed to copy/write and produced errors detected by the programmer.

3) 1 failed when I compared it

on commercial programmers after it appeared to be corrupted in some test equipment that I was using as a benchtest.

I wouldn't consider 10 failures out of 15 (33%) a good figure considering that 95%+ would be classed poor commercially.

On the criticisms of the documentation, I did get some people at the club to try it during a club meet in case I was being too harsh and their main queries were :-

a) Which way up does the master/EPROM go.

b) How are you supposed to get the masters and EPROMS in without removing your 80-column card etc.

Although there are a few criticisms the card does work after a fashion. Possibly I had a bad card to review although I would have thought MGA would have tested their review samples before despatch. Part of the learning curve I suppose. Hopefully, by the time you read this, the documentation will have been updated as it is simple to correct. On the hardware side it would be easy to remove the 'Textool' (and probably the DIP switch as well) and replace it with some ribbon cable and mount the 'Textool' (and DIP switch) on a small plastic box outside the Apple. Perhaps MGA will consider this as most people, particularly small workshops with Apples, will prefer this and will leave the card (and the rest of their cards) installed permanently.

Many thanks to MGA for the loan of the card. It is a very good to see that someone in the UK is looking after the needs of the Apple II series and being so helpful. Not only do we benefit in having equipment to review, but also MGA get's free, independent evaluation of products with both recommendations as well as criticism. Very few products are perfect when released. You only have to look at all the revisions on both hard as well as software. Customer feedback is the impetuous for change, and remember always, the customer is king, no matter what Apple UK say and do.

Martin Randall

info

Product : The Eprom Writer
Maker: MGA
Available from :
MGA Microsystems
AppleTree
Appledore
Kent
TN26 2AR
☎ (0233) 83571
Price : £87.95 incVAT
Value : 🍏🍏🍏
Performance : 🍏🍏🍏

The Boffin Answers

📍 **Englinion Road**
Dublin 4

Dear Sir,

1) Is the new Iigs System Disk V 3.1 the updated Mousedesk disk which I received with my Iigs? If not, is there a new version which will work correctly with the GS?

2) Is there any software which will allow loading of several programs onto an Apple memory expansion card in the GS, with rapid changing between programs.

3) Reviews of graphics programs never mention the printers which can be used with the programs. Can any of the Iigs programs, such as DeluxePaint II, 816/Paint or PaintWorks, print to an Epson?
Micheal Pegum

☐ 1) The Apple Iigs System disk V3.1 is the latest system disk for the Apple Iigs is based around ProDOS 16 v1.3 and contains the Finder. This disk is used for launching ProDOS 16 programs or manipulating files and whole disks. The system uses the same type of 'Xerox interface' that is used by the Macintosh Finder.

The Mousedesk disk is a ProDOS 8 based filing system similar to the Finder but much cruder - it was supplied with early Apple Iigs computers to fill a gap whilst the Finder was being written!

2) A good way of loading a RAM disk with files is ProSel Restore/Back-up. ProSel is a very good way of switching between programs.

Roger Wagner Publishing market a program 'Softswitch' which works in a similar manner to the 'Shuttle'.

3) This is a real problem since only the LaserWriter and Apple ImageWriter printer drivers are available.

The Boffin

Mac2000

Norah Arnold looks at topics of interest to the Macintosh owner.

RCA and Apple DTP Course

Europe's premiere college for post-graduate design - the Royal College of Art, and Apple Computer, the market leader in Desktop Publishing, have joined forces to offer the business community training courses in Desktop Publishing and design.

Starting in September, the Royal College of Art ran two three-day courses for business people who have a basic understanding of Desktop Publishing technology, but who lack the necessary design skills to get the most out of their systems.

"The courses have evolved as a result of the tremendous growth in Desktop Publishing," said Robin Baker, Head of Computing at the Royal College of Art. "Most organisations need to produce information and whilst this has traditionally been produced using expensive external services, in the last couple of years with the advent of Desktop Publishing, more and more organisations are realising the benefits of developing in-house resources."

Robin Baker has no doubt that the Apple system is the obvious choice for the university. "We had already been using Apple Desktop Publishing for college administration and we were aware of the advanced graphics capabilities and its ease of use. It is an ideal system for this application as it enables users to learn creativity, not technology."

The courses are a pilot, but Baker sees them as the first step in the broader Desktop Presenta-

tions area. "We are not only using Apple laser-written output but will also look at output from a host of third party printers and peripherals including flat-bed scanners, Honeywell Slide Writer and the Linotronic 300 and Monotype Blaser



professional typesetters.

"We welcome the opportunity to work with Apple as a partner and look forward to the spin-offs this relationship will bring, such as software development," said Robin Baker.

Richard Bradley, Desktop Publishing Marketing Manager for Apple Computer UK summed up the importance of the course to the industry:-

"These courses not only acknowledge Desktop Publishing as a mainstream designers power tool, they also endorse our belief that Desktop Publishing has fast become an integral part of most businesses. In order to maintain

standards and ensure that output remains of the same high quality it is vital that business people using the technology have a basic appreciation of design techniques.

The Royal College of Art are filling a market niche and we are pleased to be involved in this project which can only benefit the industry and its users."

The RCA/Apple Professional Desktop Publishing Course covered the following:- optional familiarisation for first time users; the design/print production process, both traditional and DTP; what is good design - preception; establishing standards; 'house style'; improving personal design awareness and standards; fundamentals of page design for desktop publishing; desktop publishing software overview; page design; direct input copy; typeset quality and typesetting; adding graphics, creating and using illustrations, photographs, charts; print production, including economics of print; paper, binding and finishing.

Information on any further courses can be obtained from Robin Baker or Ingrid Bleichroeder, Head of Computing, Royal College of Art, Kensington Gore, London SW7 2EU Tel:- 01 584 5020 Ext 290, 324/5

"Disk Ability"

Reading Borough Council and Reading Information Technology Centre (ITeC), have got together to launch a revolutionary new scheme to help disabled people. A high technology Computer Services Bureau, called "Disk Ability" has been created to provide Desktop Publishing, Word Processing and other computer services for small businesses. The big difference is that it will be staffed by disabled people trained by ITeC.

ITeC is one of the country's leading trainers of disabled people who want to learn computer skills, and the demand for skilled operators in the Thames Valley has never been higher. However, training alone is not enough to get them work with local companies afterwards. Disk Ability will give them up to a year's experience of the commercial computing envi-



ronment following their training. With this experience, they will be fully able to compete on an equal basis in the job market.

Disk Ability has been given a special set-up grant by Reading Borough Council, with the objective of the bureau being fully self-supporting within three years. Although sponsored by the Council, Disk Ability is operating as a fully commercial concern from the start, providing a wide range of services to local businesses. Many more local firms will now be able to make use of the most advanced technology available to help them to be more efficient and cost-effective.

In addition it aims to show that disabled people can take their rightful place and work alongside able-bodied people in the world of today, and in the future.

Enquiries to:-

Rob Collins at Disk Ability

Tel: (0734) 505662

Fax: (0734) 508315

SUM™

Symantec Corporation's Turner Hall Publishing Division are now shipping Symantec™ Utilities for Macintosh™ (SUM™), a comprehensive disk utilities package based in the popular data recovery program Mac Zap from Micro Analyst Inc. Symantec licenced the worldwide marketing and sales rights to Mac Zap at the beginning of the year to jointly create an enhanced version of the product with several new and impressive features. Symantec and Micro Analyst have significantly redesigned the user interface and added a wealth of new and powerful features to the existing Mac Zap program.

SUM's main feature is its easy to use recovery procedure for restoring crashed disks, "deinitialising"

hard disks, and for recovering files deleted accidentally. Other important features include disk partitioning, disk optimization, fast floppy disk duplication, and file and disk viewing and editing.

SUM provides utilities for recovering from almost any type of disk crash. Data can be recovered onto floppy disks or onto another hard disk drive. Among the program's advanced features is a new technology called Guardian™, which can be pre-installed onto any disk. Guardian allows users to recover from any type of disaster in a matter of minutes. Guardian also includes a special module that prevents any harmful computer virus from attacking the system.

SUM's HD Partition™ is a utility that lets users partition any disk into smaller volumes. These volumes can be encrypted and password protected for maximum security. Volumes can also be auto mounted at system startup time.

SUM's HD TuneUp™ is a fast, easy to use disk optimizer that improves disk performance by defragmenting files on the disk.

The program indicates the percentage of fragmentation both before and after optimization.

Symantec Tools is an advanced utility for viewing and editing disks and files. Data can be displayed and edited in either HEX or ASCII format. The program also shows disk structures in a graphic format.

QuickCopy™ is a fast disk duplication program that is simple to operate. The program reads all used sectors on a disk into memory and allows users to write directly from memory to one or several target disks. This is much faster than the traditional method of copying disks from the desktop and is also useful for initialising several floppies at one time.

Disk Clinic™ is a "shell" program that works as a diagnostics centre. The program asks the user simple questions about the nature of the problem and then, based on the user's answers, of-

fers a solution. Disk Clinic is also the 'launching pad' from which all other SUM programs can be started.

Symantec Utilities for Macintosh runs on the Macintosh 512Ke, Mac Plus, Mac SE or Mac II. Macintosh System version 4.1 and Finder version 5.3 or later are required.

As an introductory offer with the first 5000 units of SUM that are sold, buyers can receive a free copy of either Symantec's LaserSpeed™ or HFS Navigator™.

Symantec Utilities for Macintosh has a suggested retail price of \$99.95 and has a thirty days money back guarantee. It can be obtained directly from Symantec or through dealers. Existing Mac Zap owners can upgrade to SUM by sending in their original program disk or the cover of their user annual and a credit card number or cheque for \$30.00 to Symantec Corporation, SUM Upgrade Dept, 10201 Torre Ave, Cupertino, CA 95014.

QuickMail™

CE Software Inc. is adding a new LAN E-mail package to its line of Macintosh software. CE Software say that this second-generation electronic mail system boasts breakthrough features in a setting that doesn't compromise its ease of use.

QuickMail for the Macintosh offers real-time conferencing, password and security features, personalisation, customisable address books, priority control, return receipts, a public bulletin board and more. A QuickMail user can create and use custom forms, including graphics; reply to, edit, print or file any message; time and date-stamp messages; and even "unsend" mail. A built-in telecommunication bridge makes it easy to include remote dial-up systems, on-line services and network-to-network connections within its reach. QuickMail features seamless zone and wide-area connectivity.

CE Software also offers the QuicKeys™ keyboard enhancer, winner of the MacUser 1988 Eddy Award for the best product under \$100. This makes it easy to create a macro, that is, a sequence of keystrokes, mouse movements

and/or clicks activated by a single keystroke, to perform repetitive or time consuming operations. QuicKeys can also open files, type text, perform clicks and drags, select menu items, open desk accessories, shut down the system and more.

The ArtRoom™ CD ROM

The ArtRoom CD ROM contains more than one thousand PostScript images plus one hundred laser advertising fonts all on a five inch compact disk.

The clip art is managed by a desk accessory called the ArtRoom Retriever and categorized according to libraries. You can click on the appropriate library, choose an image, and the Retriever will place the image into your application.

The ArtRoom CD ROM comes complete with an 80 page reference catalog that outlines 150 colour clip art images for the Mac II also on the CD ROM. The clip art and fonts can be placed right from the CD into a document using

page layout programs such as PageMaker™, XPress™ or Ready Set Go™, and any other publishing program that will support the PostScript™ format.

The clip art can be published time and again without paying royalties. Using programs such as FreeHand™ by Aldus or Illustrator™ from Adobe, the desktop publisher can create exciting variations from the pre-drawn clip art there fore saving a great deal of time.

Image Club Graphics has also initiated another first as the DarkRoom™ CD ROM prepares for take-off. DarkRoom™ is a stock photo library of more than 500 professional ready to use photos all on a five inch compact disk. No royalties are payable for black and white, but they are for colour reproductions.

More information from:-

Image Club Graphics Inc,
2915-19 Street N E

Calgary, Alberta T2E 7A1



Music Mouse™

A review of this program which turns your Mac into a musical instrument you can play.

Music Mouse™ is an intelligent musical instrument which differs in several ways from the many other music programs available for such computers as the Macintosh.

Music Mouse is not designed for the storage, editing, and replay of musical compositions which involve keyboards or use normal musical notation. The program turns the Macintosh itself into a musical instrument which you can play by moving the cross wires on the screen in any direction so the pitch and sound of the music is varied. Anyone who can move the mouse can get music from the Mac using Music Mouse.

Although the documentation with Music Mouse states that you do not need a knowledge of musical theory or notation, it would be true to say that the results which you can obtain are obviously better if you do have some knowledge of how the options you are given can be used. However, it is also true that a great deal of fun and pleasure can be gained from Music Mouse without the user having any musical knowledge whatsoever.

Several reasons are given for using a musical "expert system" such as Music Mouse. It is true that the program does give the non-musician access to music-

making in a way not found in other programs. The high degree of automation in the program does leave the user free to focus on phrasing, and overall form. For instance the selection of Harmonic Parameters from the Pitch Content Menu or from the Mac keyboard gives you several impressive options: - quantization defeat, so that the mouse moves through continuous or microtonal frequency space; equal tempered scale, chromatic harmony; Middle Eastern scale; Diatonic Scale, tonal harmony; Pentatonic Scale, modal harmony; Cycle of Fourths, quartal harmony.

Music Mouse can be used as a complete self-contained MIDI controller program and can be used as an interface to play "rack mount" MIDI synthesizers which have no keyboard.

A MIDI synthesizer keyboard remains "live" while Music Mouse is running so that if desired, two people can play together, one on the synthesizer keyboard and one using the Mac and Music Mouse.

Music Mouse is published by Opcode Systems, 444 Ramona, Palo Alto, CA 94301 More info from Argent's, 20 Denmark Street London WC2H 8NA. 

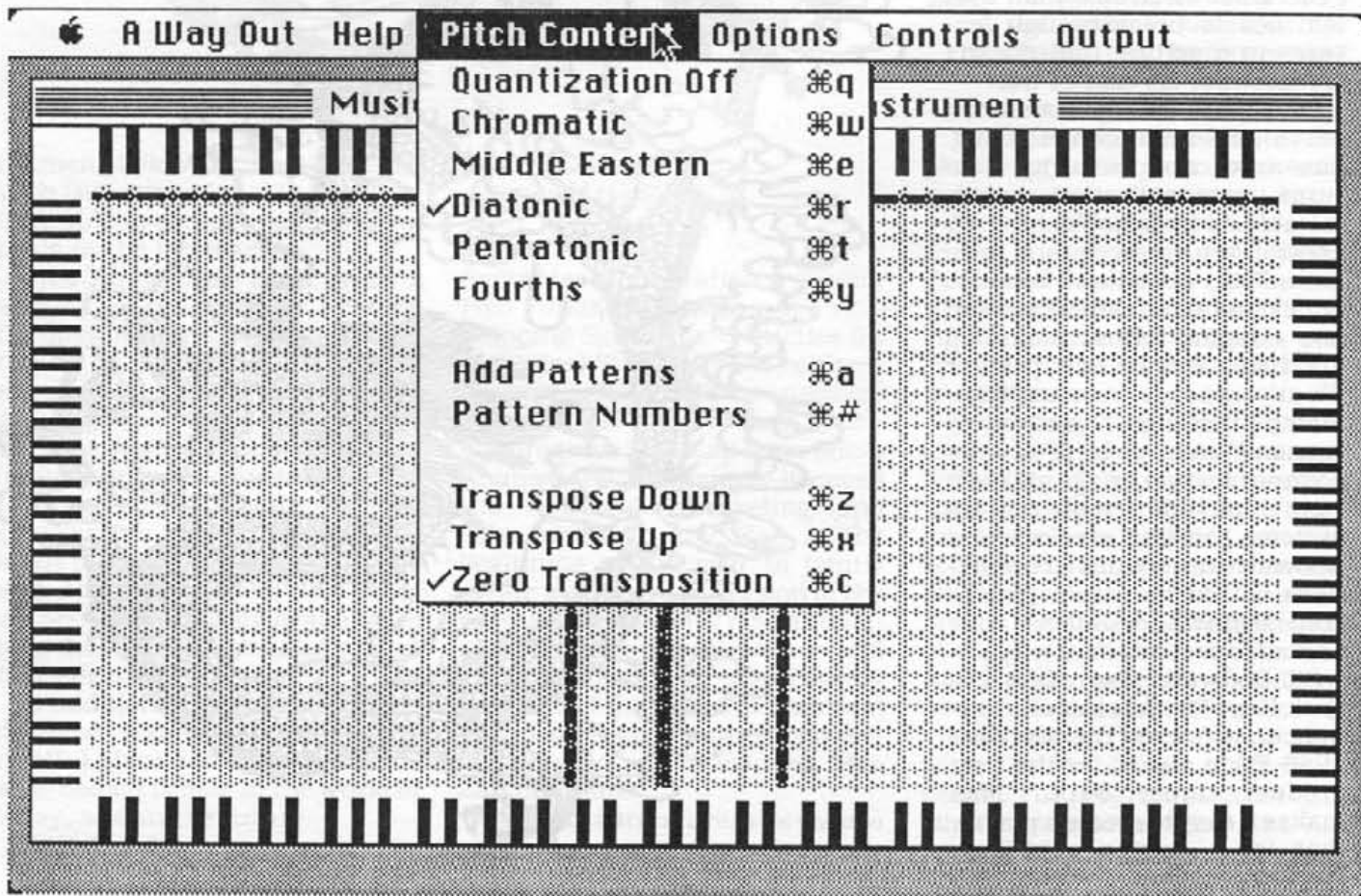

The User-Friendly Apple Dealer

(But we ain't no wimps)



Celtip Computers : AppleCentre

Lower Mill Street, Kidderminster, Worcs., DY10 2JG Telephone (0562) 822222

Lasertalk™

A PostScript™ language development environment reviewed by John Arnold

Introduction

Lasertalk is a program designed to assist PostScript programmers in the development of their programs in that it provides an interactive link with the LaserWriter over the AppleTalk network.

The package has been developed by Emerald City Software and comes with a disk containing the Lasertalk application and a variety of PostScript examples, a system disk, and a manual containing a description of all the program features, this having also a substantial tutorial section.

The Lasertalk disk is copy-

protected, and although this will allow a copy to be made onto a hard disk, on each reboot of the system the Master disk will be asked for. According to the manual, on registration a personalized unprotected copy will be sent to the owner.

Lasertalk is intended to provide the PostScript programmer with all the tools he or she will require, either for the development of their own programs, or to examine and change, if required, the PostScript produced by the increasing number of application programs now becoming available which provide this type of output,

for example:- Illustrator, Page-Maker, etc.

Using the program enables the user to work directly with the PostScript interpreter in an interactive mode, using the standard AppleTalk cable. The user has the choice of using the program in the interactive mode or not, although many of the options are not available if the non-interactive mode is chosen.

Windows

Lasertalk provides the user with a number of windows, five, in fact. These are:-

(1) the Interactive window... This allows the user to enter PostScript commands which are then sent directly to the interpreter when the return key is pressed, any feedback produced by the interpreter appears in the window, so that a dialog is possible between the user and the LaserWriter. This is a very useful feature, not least, because such dialogs are usually not possible on programs which send PostScript. That statement applies at least for the few programs I am familiar with. This is a feature which

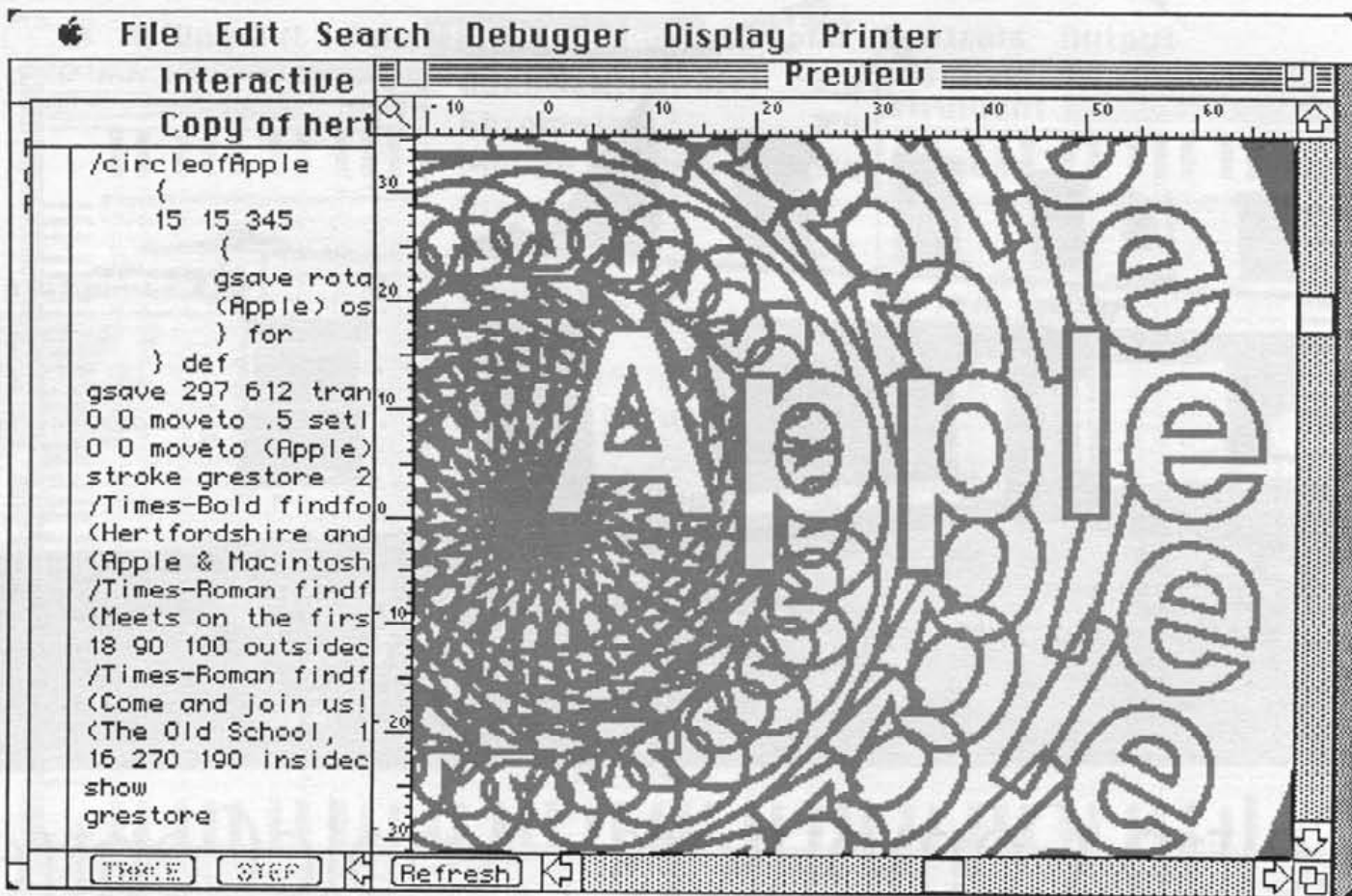

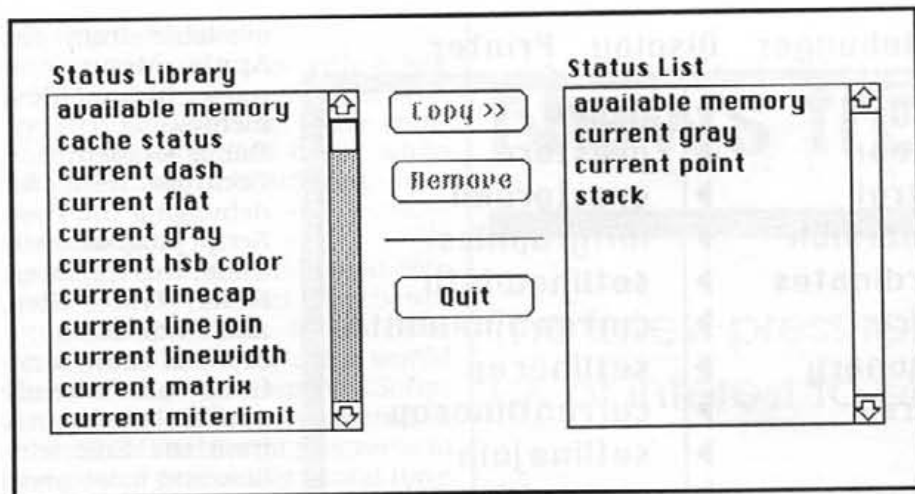

should be very useful to those beginning (and dare I say it) struggling to learn the PostScript language.

(2) the Status window....

In this are displayed the PostScript variables and stacks which have been chosen by the user by using StatusList in the Edit menu. The memory available can also be displayed within this window.

(3) the Preview window....

This to me, seems a very valuable feature offered by the Lasertalk program, because it displays the image on the screen contained

within the LaserWriter memory. The window as it first appears is set to a fairly small size, although this can be resized in the usual way, there is however a reason presumably for the initial size, and one soon discovers what it is! Depending upon the complexity the image takes a while to appear, longer for a larger window, with scrolling times seeming to be quite slow. However, it is extremely useful to have the image on the screen, even if it is convenient to have only a small portion visible at a time. Vertical and horizontal rulers form a part of the preview window so that the position of the visible image in relation

to that on the page can be seen, the rulers being graduated in PostScript coordinates, this being either user or device orientated.

(4) the Dictionary Browser....

This window allows the user to inspect the LaserWriter dictionary stack and the dictionary contents. When the window opens it contains three parts, the Dictionary Stack which displays the list of currently open dictionaries, the selection of one of these will display the entries in that particular dictionary in the Keys portion of the Browser window. The selection of one of these names will then enable the user to display in the top region of the screen its 'value'. Again this is an important and interesting feature of the Lasertalk program.

(5) the Edit window....

In this the user can enter their own PostScript program or load in existing PostScript or Encapsulated PostScript files. Only text files can be loaded in.

The edit window is one of the few options available to the user working in the non-interactive mode, files may be edited or written, but the main program facilities only become active in the interactive mode. These include the option to step or trace through the program, stops can be inserted at chosen lines to make debugging of the program easier.

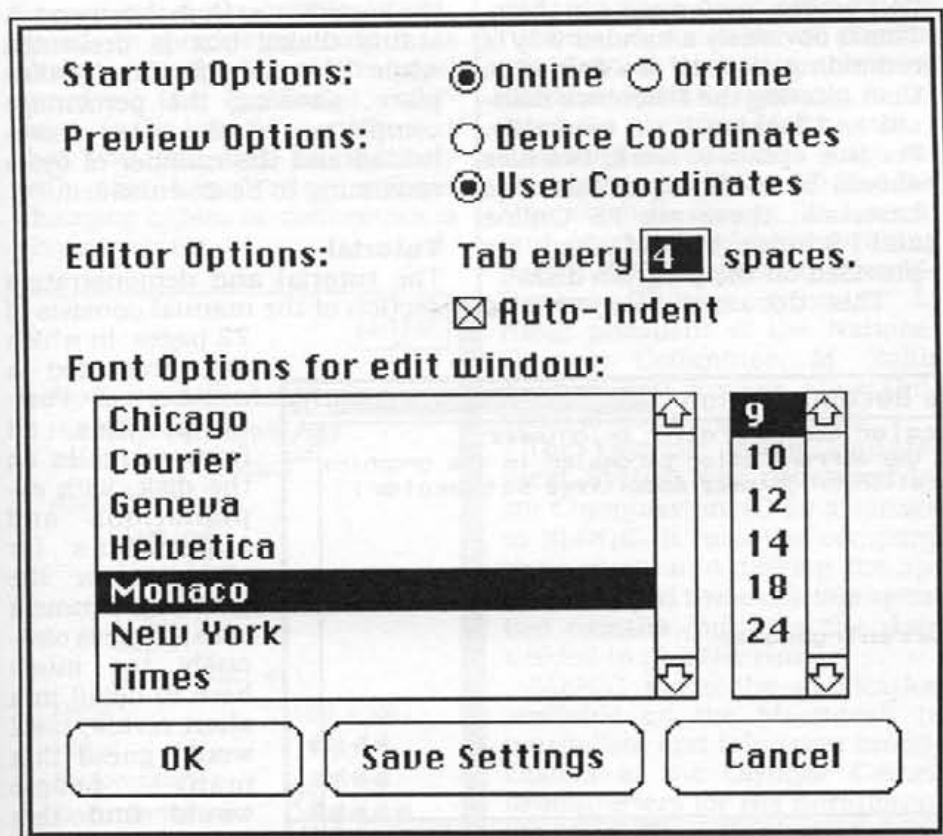

Menus

File Menu....

This has all the usual choices found in this menu, with the option of printing the file in the edit window only being available in the non-interactive mode.

Edit Menu....

Cut., etc. as usual, text can be shifted Left, or Right and there is a Format option for spacing and indenting the text and selection of the font and type size to be used, according to the settings made in the Preferences option. The last choice under the Edit menu is Status List, this enables the user to select from a displayed list of PostScript procedures, those that will be available in the Status window.

Search Menu....

Presents a series of choices for the location of specific text within the active window, and for its replace-

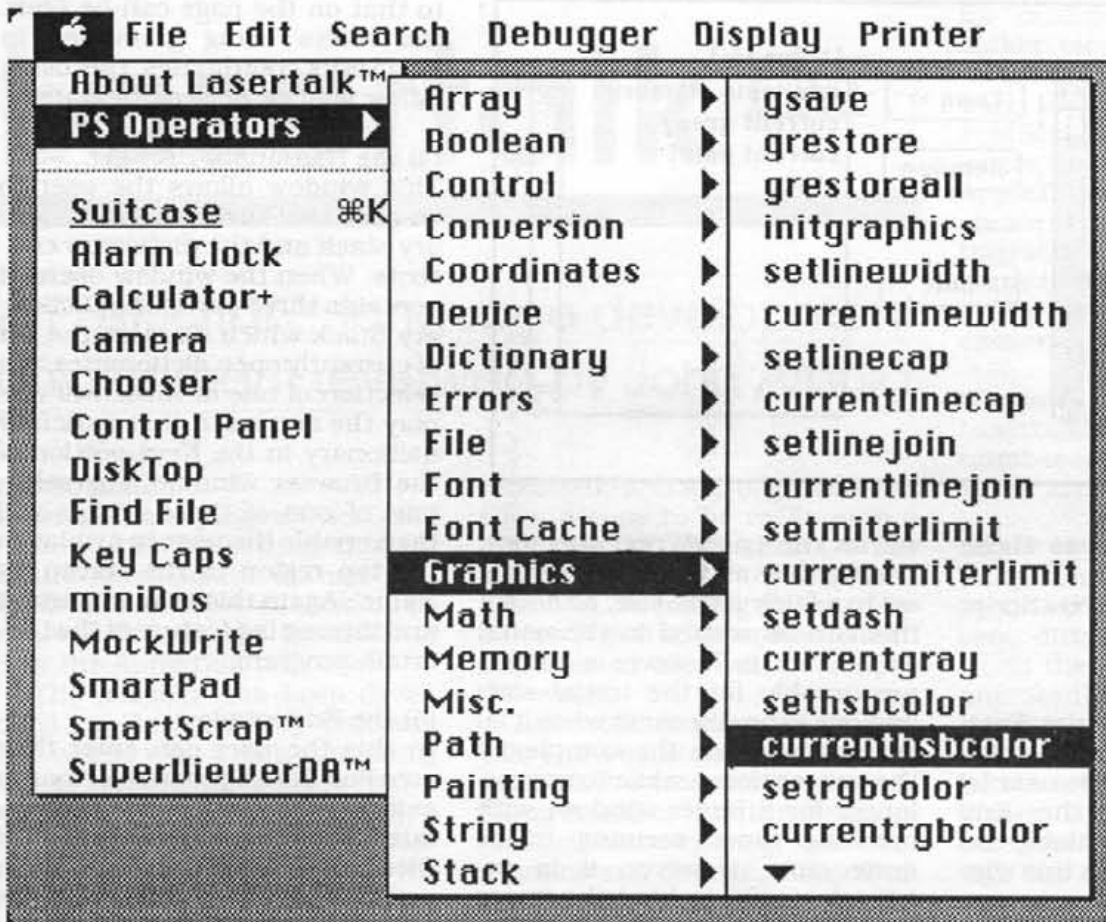

available from the Apple Menu and uses hierarchical menus. Debugger Menu.... Controls used for debugging the PostScript program come under this menu, eg. Reset, Trace, Step, and Clear Stack. Some of these functions are already available directly from the Edit window and most users will prefer the controls provided with the window or even the keyboard equivalents. The Clear Stack will carry out a clear operation and will need to be used should a routine have a problem. Display Menu.... Allows the selection of one of the many windows and brings it to the top of the desktop.

ment. It is also possible to move to the Top or Bottom of the text. Also included under this particular menu is the Dictionary Lookup, this allows the user to look up items from the dictionary stack and have their values returned. Documentation search provides access to definitions of PostScript functions as found in the PostScript Language Reference Manual. The definitions are used within the program with permission from Addison-Wesley. A warning is given in the manual that these definitions should not

be copied or printed. This option only works on text which has been selected, but further operators may be selected in the Documentation window and a Documentation search performed for them. This is obviously a handier way of reminding yourself of a definition than locating the Reference manual and looking it up manually. For this option to work, two files should be in the same folder as Lasertalk, these are PS Online and PS Index, both of which are provided on the program disk. This documentation is also

Printer Menu... The LaserWriter can be toggled into and out of the interactive mode. Also files can be downloaded to the LaserWriter from this menu. A status dialog box is presented while the downloading takes place, showing the percentage complete, and the bytes downloaded and the number of bytes remaining to be downloaded.

Tutorial
The tutorial and demonstration section of the manual consists of 72 pages, in which are presented a number of PostScript files, all from examples on the disk, with explanations and suggestions for changes for the user to experiment with. There is obviously too much here to detail in a short review, but I would guess that many people would find this section to be ex-

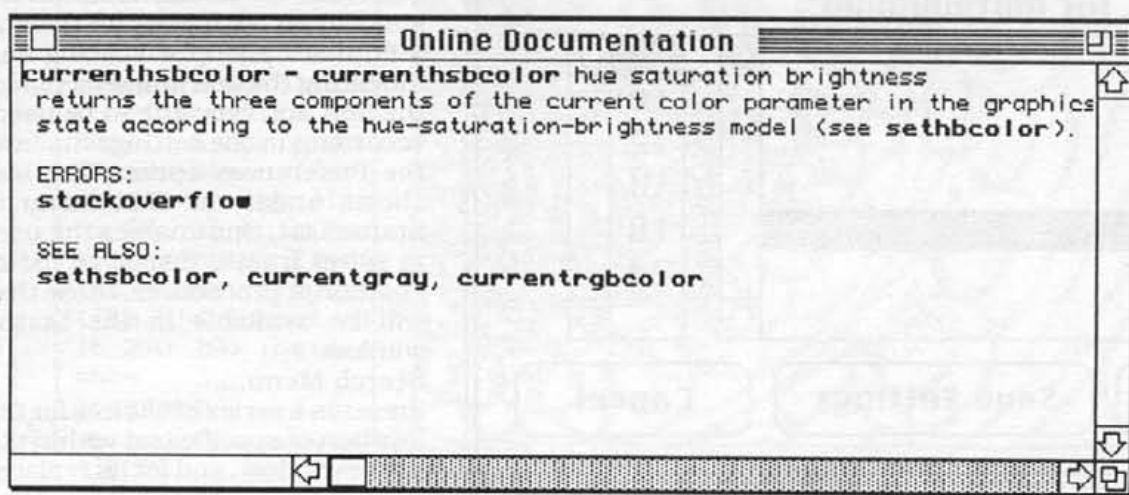

tremely valuable.

The manual ends with a few hints and tips consisting of step by step solutions to some common questions that occur while programming in PostScript.

Conclusions

Lasertalk will not make you into an instantly perfect PostScript programmer, but it provides most, if not all the tools that would be needed to develop PostScript programs. Having attempted a number of PostScript programs in the past, I personally would have found this package to be very valuable in their development. It will still be necessary to obtain the two, or now, three PostScript 'bibles' published by Addison-Wesley, these being PostScript Language Tutorial and Cookbook, the PostScript examples from this being provided on the disk, PostScript Language Reference Manual, information from this again provided on disk in the PS Online file. The third which was published after the manual was printed being PostScript Language Program Design.

Buy the books and more importantly buy Lasertalk and if you haven't already started, put yourself on the route to becoming a PostScript programmer!

I like Lasertalk, as you may have guessed. Any problems with speed in producing output is almost entirely due to the snail speed of the PostScript interpreter in the LaserWriter. The fact that you can talk interactively with the LaserWriter without changing cables or connectors is very attractive. 🍏

info

Product: Lasertalk™
Publisher: Emerald City
Software

Available from:
MaLine
Wren House
Sutton Court Road
Sutton
Surrey SM1 4TL

Price: £ 169 + VAT
Value: 🍏🍏🍏🍏
Performance: 🍏🍏🍏🍏
Documentation: 🍏🍏🍏🍏

News from Apple

The latest press releases from Apple UK of interest to Macintosh owners

4th Dimension Tracks Olympic Runners

The Seoul Olympic Organisation Committee (SLOOC) kept track of more than 20,000 participants in the "24-day Olympic Torch" relay run by using a 4th Dimension (4D) relational database application on Apple Macintosh II computers.

The 4,295.6km run, which marks the traditional build-up to the start of the Olympic Games, began on August 27 in Cheju, Korea, and passed through six major cities before finishing in Seoul stadium on September 17.

A vast array of information was monitored by the application, including full colour maps plotting each segment of the relay course, scanned photographs and recorded comments of the runners. A database of participants' vital statistics, clothing and shoe sizes, for example, facilitated the planning of the event.

All the information was instantly accessible via 4D and the Macintosh II. Among the Korean and overseas celebrities taking part in the run were the world-famous Chinese gymnast, Li Ning; president of the National Olympic Committee, M. Zahir Naheer; and Korea's Miss Universe entrant, Jae Ho Song.

The Olympic Torch Management System was developed by Bit Computer on 4D as a service to SLOOC. It took the company three months to develop the application and three officials spent two months inputting the data needed to plot the run.

SLOOC made the application available on the Macintosh to journalists and television broadcasters at the Olympic Games headquarters for the duration of the relay. The daily plotting of the

run enabled them to receive up-to-the-minute information regarding the status of the event.

The 20,756 people in the relay included runners, back-up runners and escorts. Out of this total, 1,282 were main runners, each covering one segment of the relay.

An average of 195.25km was run each day. The shortest sector of 0.4km was covered by Joseph Ku, a Catholic priest. The longest segment of 6.3km was run by Korean athlete, Jeong Soo Kim.

The oldest participant was 79 year old Jae Soong Kim, an experienced marathon runner. Nine year old Korean primary school pupil Eun Mie Kim, was the youngest runner.

NB. 4th Dimension is a relational database management system which includes its own programming language, Macintosh style layout graphics, runtime and multi-user and many customisation capabilities. It permits a user to analyse and control large amounts of information and reduces custom development and support training costs.

Price Rises

Apple Computer have announced world wide price rises ranging between 5 and 75%.

Apple Computer UK have said that these are the first CPU price rises in Apple's history. Most observers have linked the price rises with the shortage of D-RAM memory chips.

New Macintosh IIx

Just as we go to press Apple have announced the IIx, a four megabyte version of the Mac II with a Motorola 68030 and a new 3.5" drive which can also read and write MS DOS format disks. 🍏

Network News

The latest news, tips and gossip
from the networks.

From INFOMAC

From: "Charles E. Bouldin"
<bouldin@sed.ceee.nbs.gov>

Subject: **Dumping Postscript to a Remote Printer**

Reply-to: "Charles E. Bouldin"
<bouldin@sed.ceee.nbs.gov>

For some time I have been unable to buy a laser printer, although there are many postscript printers nearby at work. If you are in a similar situation and wish to print on a "remote" laser printer, ie, not connected to you by appletalk, here is how to do it.

First, create a postscript file by holding down 'command shift f' as you release the 'ok' button in the standard print dialog box. This creates an ascii postscript file. You must choose the laserwriter driver from the chooser before you print, and it does NOT matter if there is no laserwriter connected to your system when you do this. To dump the postscript out, use the utility "SendPS" to dump the file out on the remote Mac system. SendPS is only 32K in size, so you have room for 750K of postscript on a floppy that you can carry to the remote system. (To set the scale, a 20 page TeX document produced 450K of postscript, while a one page bitmap is 69K) The beauty of this is that SendPS works with output from ANY Mac application.

This works wonderfully for me. I have tried it with a Laserwriter NT and with a 600 dpi Varityper printer. If you have a printer nearby at work or a shared printer at a University, or if you use the printers at Kinko's copy centers, this process should be of some help.

From: tom coradeschi
<tcora@ARDEC.ARPA>

Subject: **Mac Postscript generation**

I've been noting the discussions regarding the creation of postscript files on the Mac recently, and feel that a number of items need to be outlined, so misunderstandings are kept to a minimum. It is quite easy to create postscript files from ANY application on your Macintosh. After creating the document, and formatting it in the style you wish to have it printed in, choose print from the file menu, just as you normally would. Immediately after clicking in the OK box, hold down either the f or k keys. You will create a PostScript file on the disk the application is on, called "Postscript0". Your next file will be "Postscript1", then "Postscript2", etc, etc. It is not necessary to hold down the command-option, or command, or option keys along with f or k after clicking on OK in the print dialog. Just hold down the single letter key. Any other key is unnecessary.

While you can hold down either of two keys, f or k, there is a difference between the files created. When you use k, your postscript file will be prepended with the laser prep file for your machine. If there is some question as to whether or not your Mac has the same laser prep version as that used to initialize the laserwriter, then use this option to create the first postscript file you will print (ie Postscript0), and hold down the f key for all files following that one.

The difference between using f & k, in terms of disk space consumed is as follows. This letter was composed using Microsoft Word 3.01, and the Postscript files described were created from within Word.

File size	3k
PostScript0 (using k)	33k

Postscript1 (using f) 5k

You can see that the laser prep file will increase the size of your postscript file by about 27k. Then printing a large number of small files will mean that using the k option burns up more disk space for laser prep code than for the files themselves. **Moral: Use k for your first file, and f thereafter.** The above is correct as I know it. If anyone notes any discrepancies, please email to me, and I will post a correction.

tom c

From: Murph Sewall
<SEWALL%UCONNV.M.BITNET@For
sylhe.Stanford.EDU>

Subject: **July Vaporware** - send rumors; see your name in print!
VAPORWARE

Murphy Sewall

From the July 1988 APPLE PULP
H.U.G.E. Apple Club (E. Hartford)
News Letter \$15/year P.O. Box
18027

East Hartford, CT 06118

Call the "Bit Bucket" (203) 569-
8739

Permission granted to copy with
the above citation

NeXt: The Continuing Saga.

The introduction date for the new computer from Steve Jobs has slipped so often it's even giving the term "vaporware" a bad name. Perhaps the machine should be christened the Month (as in the "NeXt Month"). The latest delay in the debut of the black magnesium cubic (hmmmm... a "Black Box") computer is said to be caused by a slow screen display, in spite of dedicated video chips. The operating system will be a Unix variant known as "Mach" (will the "speed of sound" be fast enough?). Other technical details and prices (still \$4,000 to \$9,000) of the 68030 machine were described in last January's column. - Time 20 June

Open Look's Look.

If the NeXt computer succeeds, expect AT&T to press for the adoption of Display Postscript for Open Look, the common user friendly Unix interface announced by AT&T and Sun and endorsed by Unisys, NCR, Olivetti, and Xerox. - InfoWorld 13 June

Tektronix recently unveiled the first Motorola 88000-based development card for the Macintosh II. The Tektronix TL88K-P card runs at 20MHz and provides 17 million instructions per second, about 10



times the speed of the 68020, according to the company. The card is intended for developers creating software for the 88000 platform. The Tektronix card features eight Mbytes of memory, three cache memory management units, and diagnostic and control software. The price of a fully configured board is \$14,995, though lower priced configurations will also be available.

- Boston Computer Currents 3 June (forwarded by Tom Metro)
Super Macintosh.

Meanwhile Apple is said to be working with the Motorola 88000 chip set too. The company has built prototypes of a "Super Macintosh" intended to be a powerful network server. Apple could bring this machine to market in about a year for between \$15,000 and \$20,000. - InfoWorld 30 May
A 20 MHz 80386 Laptop.

U.S. Micro Engineering of Boulder, Colorado is launching a line of laptops that includes a 20 MHz 80386 model that supports up to 300 Mbytes of hard disk. The standard \$5,995 version will weigh 15 pounds when equipped with 2 Mbytes of RAM, a 50 Mbyte hard disk, and a 640 by 480 dot backlit supertwist LCD. - InfoWorld 6 June

The Macintosh III as a Laptop?
Apple's R&D gnomes are reported to have built a 15 pound Macintosh laptop around a Motorola 68030 and a super-quick 20 Mbyte hard drive. The display is an active matrix screen. The company could decide to market the machine as early as next January, perhaps; well, maybe.

- PC Week 31 May

What Happened to the A/Ux Applications?

When Unix for the Macintosh II was released in February, Apple promised easy movement of applications from the standard Mac operating system. However, only Informix which makes the Wingz office automation program reports little difficulty moving their Macintosh application to A/Ux. Microsoft has reported that none of its applications - Word, Works, Excel - will run under A/Ux without extensive modification. - PC Week 14 June

What Happens to AppleTalk?

Apple vice president Jean Louis Gasee is quoted as saying that Apple will support the Macintosh

running as a client workstation under Microsoft's OS/2 LAN manager for an IBM token ring network. However, Gasee did not elaborate on how or when this would happen, and other Apple officials have no comment on the subject.

- InfoWorld 30 May

But Who Gets the "Look and Feel?"

Screenplay Systems will soon release to developers "The Macintosh Compatibility Package" (MCP) which will allow software written in C for the Mac to be easily converted to run under MS-DOS with the same look and performance. The compatibility package provides screen handling and other routines that allow the ported code to be run on a PC. Programs written in C for MS-DOS also can be converted to run on a Macintosh with equal ease. - InfoWorld 13 June and PC Week 14 June

The Latest (Perfect) Word.

Analysts are surprised that Microsoft doesn't expect to have Word 4.0 available for the Macintosh until October. Although version 4.0 is impressive, users may not want to wait; both Word Perfect and Fullwrite have been gaining share in the Macintosh market. Meanwhile, Word Perfect 5.0 for MS-DOS computers uses a new file structure that is incompatible with Xerox's Ventura and Aldus's Pagemaker. Both Aldus and Xerox have indicated that future versions of their desktop publishing packages will support the new file format, but no release dates have been set. Compaq owners need a ROM upgrade (\$60 unless the computer is still under warranty) in order to run the latest Word Perfect.

- PC Week 14 June

Lateware.

Ashton Tate now says that often delayed dBase IV definitely will be out by the end of September (wait and see). In the meantime, a revised version of Framework has been announced for the July 31 date that was to have seen the new dBase. Not to be outdone, shipment dates for Lotus's Agenda and Modern Jazz also are slipping toward Fall.

- InfoWorld 30 May

Disclaimer: - My employer isn't responsible for my mistakes AND vice-versa!

ARPA: sewall%uconnvm.bitnet@mitvma.mit.edu

Murphy A. Sewall School of Business Admin. Univ. of Connecticut

From USENET

From: lsr@apple.COM (Larry Rosenstein)

Subject: Re: **Design Philosophy**
In article <434@dogie.edu> terranova@vms.macc.wisc.edu writes:

> A friend of mine recently expressed his disapproval of the standard Macintosh program design. Rather than putting windows, menus, icons, def procs, strings, controls, etc. in resources he would prefer to hard code everything into the program and make heavy use of #define statements. He would change the #defines instead of the resources. "That's why they made the pre-processor."<

The main motivation for using resources was to allow programs to be customized for international markets without recompiling them. All that you need to localize a program for France, for example, is the original English version and a resource manipulation tool (ResEdit, etc.). This is very important for commercial applications, because non-US markets are significant, and it is impractical to recompile the code for each country.

It is also convenient to place user configuration information in resources.

Because the Resource Manager looks for resources along a path of open files, you can put the default resource in the application, and override the default with a resource in the preferences file, or in the document file (to override on a per-document basis).

In many cases, placing this information in a resource (as data) takes up less space than specifying the equivalent information programmatically. The more information you put in the resource the more this saving will be. Imagine creating a dialog box programmatically vs. specifying a dialog template.

The only disadvantage of using resources is that it requires another step in the application build process. On the other hand, once you have the resources defined, it is not necessary to rebuild them. If you embed the equivalent infor-

mation one of your code files, it will be rebuilt whenever that code file is recompiled.

I can see how it might be easier to get things running without using resources if you were using Lightspeed C, because LSC doesn't have a resource compiler/editor integrated in the environment. Unless you were using MultiFinder, you would need to exit LSC to create the resources. Another factor in using LSC is that compilations are so fast, that it doesn't matter if you have to recompile a file to change the position of a window. In MPW, however, it takes less time to recompile your resource file than recompiling and relinking your code.

Larry Rosenstein,
Object Specialist
Apple Computer, Inc.
20525 Mariani Ave,
MS 27-AJ

Cupertino, CA 95014
AppleLink: Rosenstein 1
domain:lsr@Apple.COM

From: jwhitnell@cup.portal.com
Subject: LightspeedC 3.0 Review

A Review of THINK' LightspeedC (TM) 3.0

By Jerry Whitnell July 8, 1988
Copyright 1988 by Jerry Whitnell
All rights reserved.

I just received my copy of THINK's LightspeedC Version 3.0 and after playing with it for a several hours will attempt to review it. I bought the original LightspeedC Version 1.0 at the San Francisco MacWorld where it was introduced, so I have some experience with the product. I will assume you are familiar with LightspeedC and so will comment only on what's changed between Version 2.15 and Version 3.00. Note this is not the upgrade (which I ordered but haven't received), but a copy I ordered from MacConnection (Overnight for \$95+\$3, ordered yesterday received today). I won't make any more comments about that mostly because, even on the relatively liberal policies of the account I'm using, any comments I made would get me tossed off :-).

The Packaging

LightspeedC comes in a real box, unlike the shrink-wrapped manual that delivered 2.15. Inside are

two disks (800K), two manuals and various pieces of product literature from Symantec. The two manuals are much smaller than the original 8 1/2 by 11 manual. Much of the material is from the original manual or the 2.03 addendum, but there is also a lot of new material as well.

The first manual is the User's Manual and describes both the integrated Compiler/Editor and the Source-Level Debugger, while the second is dedicated to the Standard I/O Library supplied for UNIX(TM) compatibility.

The Compiler/Editor

The Editor portion of the compiler appears to be completely unchanged from the 2.15 version. The compiler, however has many useful changes. The most obvious are those for the source-level debugger. By setting a checked menu option (or in the options dialog box) you can tell the compiler to generate the information the source-level debugger needs to run your program. When you do this, a little bug appears by the word Name in the project window (NO! not more bugs in my program!) and each .c file in the list has a little diamond placed by it's name in the project window. By clicking on the diamond you can enable/disable symbol table information for that file. This is useful to save room on your disk, since the symbol table information can double the size of your project file (270K to almost 600K in my case).

The Options Dialog has undergone major surgery to reflect changes to the compiler. Options are now stored in the Project, rather than in LSC itself, but you can specify the default options for any new Project. The options that are new since 2.15 are in the area of code generation, precompiled headers and, of course, the debugger. You can specify that the generated code use 68020 instructions, '881 instructions (or both), in which case the code will only work on those processors. There is one precompiled header (called MacHeaders) that you can have LSC load before each file. This speeds up the compile since LSC doesn't have to reread the .h files from the disk for every file. The default MacHeaders comes with a subset of the Macintosh

Include files, however you can also precompile a new MacHeaders to include the rest of the Macintosh header files, the standard I/O Header files or your own common header files. Finally, one can specify whether to include the strings in the DATA resource or (as in 2.15) include them in a separate STRS resource. Including it in the DATA resource allows smaller code since the strings can be referenced off of A5, but limits the total strings+data to be 32K. Leaving the strings in the STRS resource allows you unlimited strings (but still only 32K of data), but you pay the price of larger code. I'll comment on the debugger options when I describe the debugger.

The Project Type Dialog box has also received many new fields. From it, you can now control the MultiFinder flags and default size fields for your application.

If you are building a Desk Accessory or Driver, you can specify you want it multi-segment and set the flags as well. Finally for the code resources, you can also specify the attributes and whether you want to use the default header or add one of your own.

Other minor changes include "Smart Linking" is now an option during the link program phase, selected by a check box in the Save File SF dialog.

The other feature that didn't change was the inline assembler. A major lack for 3.0 is the lack of support for 68020, 68881 and 68851 assembly instructions. A slightly less major lack is a Print All commands to match the Save All and Close All.

The compiler itself seems to be slower than the 2.15 compiles. Even with the source level debugger turned off, the compiler ran 3 to 4 thousand lines/second slower than the 2.15 version. Rebuild the project with LSC 3.0 (instead of using an imported 2.15) helps alot, but it is still not as fast. Overall compile times are faster due to removal of all the extra .h files the MacHeaders replaced. My tests showed about a 25% improvement, your mileage may vary.

The Debugger

And now, the moment you all have been waiting for... Once you've selected the debugger option and

recompiled all your files, all you have to do is select Run and up pops the LightspeedC Debugger. But don't forget to load MultiFinder, otherwise your program will run without the debugger.

When you Run your Project, LightspeedC finds and launches both your program and the debugger. Control is given to the debugger, and it puts up two windows and several menus. The window on the left is the source code window and will display the first page of text of your program. The right-hand window is the data window, more on it in a moment.

The text window is a standard text display window with scroll bars, but several extra features. Down the left hand side is a black arrow which points at next C source statement to be executed. Between the arrow and the left hand side of the window are a column of open diamonds. These represent executable statements, statements that generate no code (such as declarations and comments) have no diamond next to them. In the bottom left-hand corner is the name of the current function the text comes from. Across the top are a row of square buttons that control program execution. These are Go, Step, In, Out, Trace and Stop. Go tells your program to take off and run, Trace steps one source statement, In steps into a function (as does Trace), Out will return from the current function to the caller and Step steps over function calls, stopping at the next source statement after the function. You can go into Auto-step or Auto-Trace by holding down the Command or Option key and clicking on the Trace or Step buttons. This will cause your program to continue updating the debugger window while executing until you click the Stop button or Command-Shift-Period.

You can click on the diamonds (turning them black) which will cause the program to stop executing when it reaches the statement the diamond marks. You can set as many breakpoints as you want by clicking diamonds. You can also set a temporary breakpoint by holding down the Command or Option key when clicking the diamond. This temporary breakpoint will be removed when any

breakpoint (either the temporary or a permanent one) is reached.

The data window lets you display the value of any C expression except those that have side effects in any of several formats. Simple objects such as ints, longs and pointers can be displayed as numbers, characters or (for pointers) strings. Structs, arrays and unions are identified by indicators (struct, [], and union) and the address of the object. Double clicking on the data portion will bring up a separate window that displays the fields of the structure. You can repeat this ad nauseam or until memory in the debugger runs out. One nice feature is that you can case types (just like real C) so you can display data using different types.

Another nice feature is it knows all the preprocessor symbols as well as the C symbols. Finally, by default the values of each expression are updated on entry to the debugger. However you can place a lock on an expression which prevents the value from being updated. This is useful to watch how a value changes because of some operation or function.

One feature combines the data windows and the breakpoint window. By selecting a statement in the text window and an expression in the data window one can make a conditional breakpoint that breaks only when the expression evaluates to non-zero. Otherwise your program keeps executing.

Finally there is some limited communication between LSC (which is still executing) and the debugger. By selecting a menu option in the debugger, you can bring up the file you are executing from in a LSC editor window and edit it. Similarly, you can select a file in the LSC project and return to the debugger bringing it up in the text window. This latter is a clumsy but useful way to set breakpoints in a file other than the one you are executing.

You can (via the Monitor command) also enter low-level debugger such as TMON or MACSBUG. LSC still comes with MACSBUG, but they removed the section in the manual on it so you're on your own.

Finally if you fortunate enough to have both a Mac II and a second monitor, you optionally tell the

debugger to bring up the windows on the second screen.

All-in-all, I have mixed feelings about the debugger. There are lots of useful features in it, but I have lots of nits to pick with the user interface. For example, as mentioned above, there is only one text window and to bring up the text from other files you must go back to LSC (unless you execute code from that file in which case it is automatically displayed in the text window). And while multiple data windows are allowed, only the original one can have data entered into it. The others only display the fields of structures that you have opened. And while there is a Windows menu, the only two windows that you can select from it are the two original windows! If you open another to display the fields of a structure, it doesn't get added. Get enough windows and things get hard to find. Finally, I can't resist playing arm-chair quarterback and wonder why the debugger is a separate application and not integrated with the editor/compiler.

It seems the current design leads to kludges and lots of wasted memory.

However the system works well together and in spite of the criticisms it does a good job of helping debug your programs. And one nice feature is that it is guaranteed to make any user of Microsoft's QuickC or Borland's TurboC eat their heart out.

Jerry Whitnell

jwhitnell@cup.portal.com

..!sun!cup.portal.com/jwhitnell

Info-Mac digests consist of submissions by individuals on the academic computer networks. Submission and distribution of these digests is by network, moderated by volunteers at Stanford University.

Usenet is a loosely-coupled network of co-operating academic and commercial computer systems. It is a non-profit network whose primary aim is the sharing of technical information and the spreading of research results.

Delphi is a commercial time-sharing and bulletin board system. The Delphi Digests are made available thanks to Jeffrey Shulman of Rutgers University.

Steelers



Tampa Bay
Buccaneers



Are you keen on American football? If you are these NFL Football pics might appeal to you. Watch out for them on Disks 258 and 259 of the new MacLibrary disks.



**DALLAS
DALLAS
DALLAS
DALLAS**



**COWBOYS
COWBOYS
COWBOYS
COWBOYS**



Two new machines from Apple

On September 19th, Apple Computer UK Ltd announced two new additions to the Macintosh range:-

The first is a new configuration based on the Apple **Macintosh SE**. The new unit features two megabytes of random access memory and an internal 40 megabyte hard drive, and maintains the Macintosh compact design, an 8 megahertz Motorola 68000 microprocessor chip, and a Macintosh SE-bus expansion slot. Up to six external SCSI peripherals can be daisy-chained via the external port.

Available in October, the Macintosh SE 2/40 has a suggested retail price of £3495 (excluding VAT).

The second is the **Macintosh Iix**, an extension to the company's Macintosh II line. It is the first Macintosh II computer to use Motorola's 68030 microprocessor and its 68882 maths co-processor. It is also the first Macintosh to provide a 3.5" floppy disk drive that can read and write to MS-DOS and Apple II formats.

(Who said that Apple forgot about the Apple II?)

The Macintosh Iix provides users with an additional 10-15% performance improvement over the Macintosh II, but virtually all Macintosh II-compatible software runs without modification on the Macintosh Iix.

Apple's new 1.44mb floppy disk drive (FDHD) provides the capability to read and write IBM's MS-DOS and OS/2 files, as well as Apple's ProDOS files (in conjunction with the Apple File Exchange utility), thereby offering Macintosh Iix users a convenient means of exchanging information.

The Macintosh Iix comes in two configurations - with either a single 1.44mb floppy disk drive, or with a 1.44mb floppy and 80mb hard disk. The system also comes standard with 4mb of RAM enabling users to run advanced applications while taking full advantage of the capabilities of MultiFinder. The Macintosh Iix still uses the features of the Macintosh II, including 256kROM, high resolution colour, graphics, sound, NuBus and the SCSI interface which allows up to seven peripheral devices to be daisy-chained to the system.

The new high density disk drive can store 1.44mb of data on a 3.5" floppy disk; but can also read, write and format 400k and 800k disks from existing Macintosh computers and read files created under the Apple II ProDOS operating system, or MS-DOS diskettes with densities of 720k and 1.44mb. Files can be transferred between different operating environments with the help of Apple File Exchange, which is supplied as part of the system software.

The Macintosh Iix, with 4mb RAM and a single 1.44mb floppy disk drive will retail at £4995 (excluding VAT); the version which includes the 80mb hard disk will retail at £6195 (excluding VAT). Both should be available in October, with upgrade kits for existing Macintosh users to be announced soon after that (no prices have been quoted, yet).

The above details have been extracted from Apple Computer UK's press releases dated September 19th. There are many rumours of price increases, too - but these have not been confirmed. There is speculation that this is the reason why they did not advertise in this issue, but the official reason was that the advertising budget all had been spent.

Shareware & Public Domain Software

The latest shareware and public domain software from the USA for the Apple // computer.

More than 200 disks including Family Tree, CAD, Print Shop graphics and fonts, Diversi Dos & Copy, Appleworks Patches, Mouseprintz, Early Learning, Education, Graphics, Music, Games and much more.

Only £4.50

Send an SAE for a copy of our latest catalogue.

COMPUTABILITY

PO Box 1 Hedge End Southampton Hants SO3 4QJ

Telephone (04892) 6229

All prices include postage, packing and VAT



3.5"
(DOUBLE SIDED / DOUBLE DENSITY)
SONY DISKS

BOX OF	£13.95	BOX OF
TEN		TEN

Mac Recorder £ 112.00
Chinon 800K Disk Drive ... £ 152.00

MANY MORE ACCESSORIES AT LOW PRICES
ALL PRICES EXCLUDE VAT

ACCESS FACILITIES AVAILABLE

FOR MORE INFORMATION CONTACT
SUE ON 01-205 6363
C&C INFORMATICS LTD
58 CANTERBURY COURT SOUTH ACRE
LONDON NW9 5FS

Crystal Paint™

This imaginative painting program is reviewed by Geoff Wood

If you have used MacPaint you will be familiar with the effect of using brush mirrors to get two or more images as you draw. Crystal Paint takes this idea further by providing 30 different patterns to draw ingenious designs.

When you start up Crystal Paint you see a large blank rectangle in which to draw. The upper left hand side of the screen shows the Control Panel with several icons and buttons to help you to draw. Below the Control Panel are three panels which give some information about your drawing. The menu bar shows seven menu headings, namely, File, Edit, Display, Central, Crystal, Conformal and Help. (See Figure 1.)

The large black panel at the bottom left shows a sample of the repetition pattern which will be used when you draw. Just above this black panel is a white panel containing the scientific name for

the type of pattern. Thus pattern C6 shows six letters F's arranged as a star. When you draw with this pattern you get 6 copies of everything you draw, arranged in the same way as the F's in the pattern sample.

Everything you draw, from the time you hold the mouse button down until the time you release it, is called a trail. Crystal Paint treats each trail as a unit which is separate from all other units in any design you draw. Above the pattern name is a panel that shows the total number of trails in the drawing and the number of trails currently displayed on the screen. A button above this panel allows you to Undo and Redo the last trail drawn. (You can delete other trails as described later.)

Crystal Paint offers three background shades - white, grey and black - which can be called up by clicking the appropriate icon in the Control Panel. It also offers

two pens - black and white - in three thicknesses, again called up from the Control Panel (but some patterns permit only one thickness).

The Central menu offers 10 patterns (see Figure 2) which rotate round a central point (except for C1 which does not copy the trail you draw). The Crystal menu offers 17 patterns which do not have a centre. These are the classic, infinitely repeating patterns used by artists for many centuries. They permeate the art of the Middle East. Mathematicians have proved that there are only 17 such patterns in two dimensions.

The Conformal menu offers 3 patterns which have a centre but, unlike those in the Central menu, the copies in these patterns are contracted or expanded around the centre.

When you are drawing with a Crystal pattern, a vertical scroll bar appears in the Control Panel with a number in the scroll box ranging from 10 to 50. You can change the scale (i.e., the distance between repetitions of the trails) by moving the scroll box or by clicking on the arrows at the top or bottom of the scroll bar. Each trail can have its own scale so you can mix the scales within one design.

In the Edit menu there is an Edit Trails command. It allows you to step through a design, one trail at a time, by using the Next button in the Control Panel. The last trail drawn can be eliminated by clicking the Undo button. The number of trails shown in the trail count panel is then reduced by one.

Also in the Edit menu is the Edit From command. If you had a drawing with, say, 50 trails and you wanted to edit the last 10 trails, you could use this command to start editing at trail number 40.

You can move the last trail drawn by using the Move Last Trail command from the Edit menu. The last trail you drew is framed with a flickering rectangle which you can drag to a new position. When you click the Move It button on the Control Panel (this button replaces the Undo button when you choose the Move com-

Figure 1

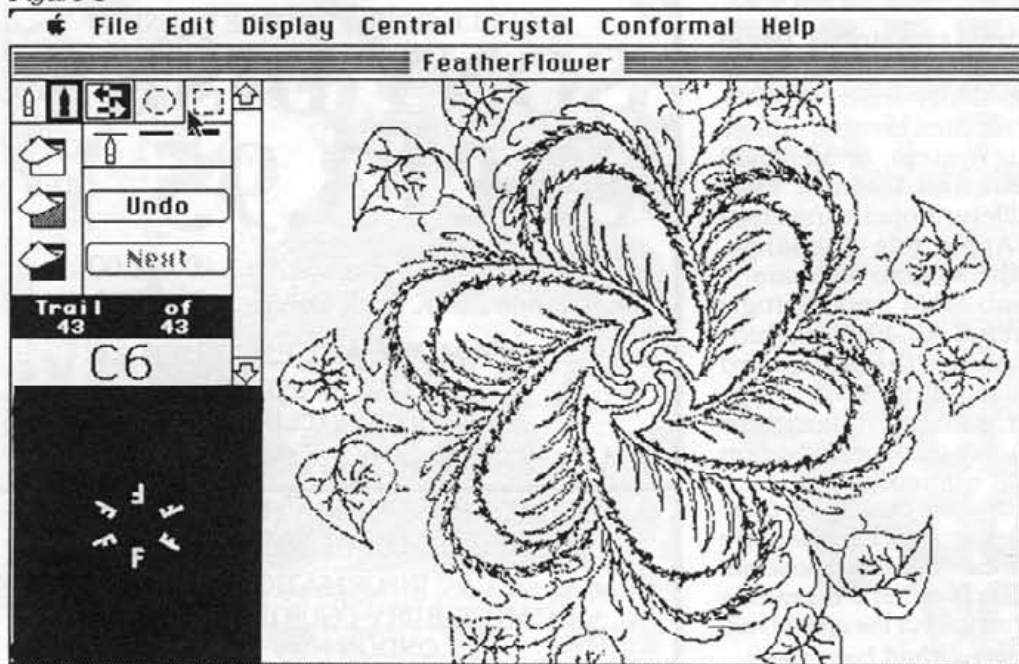

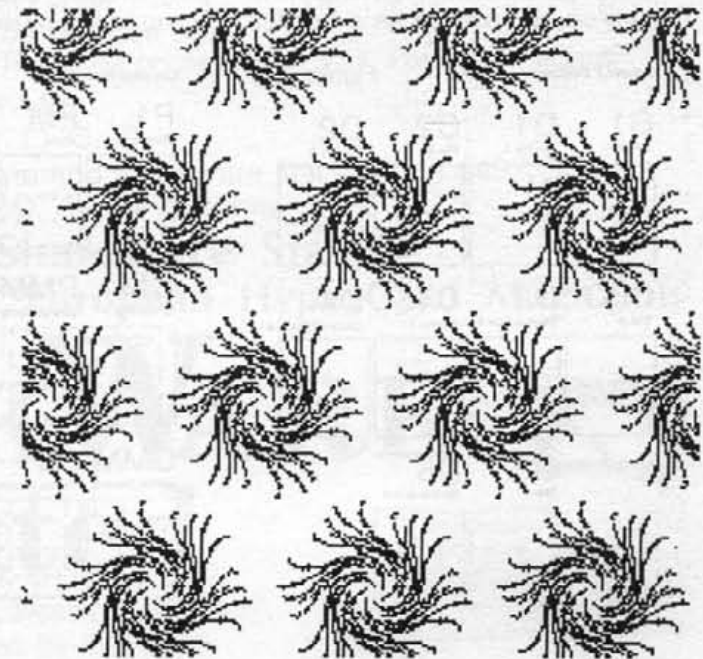
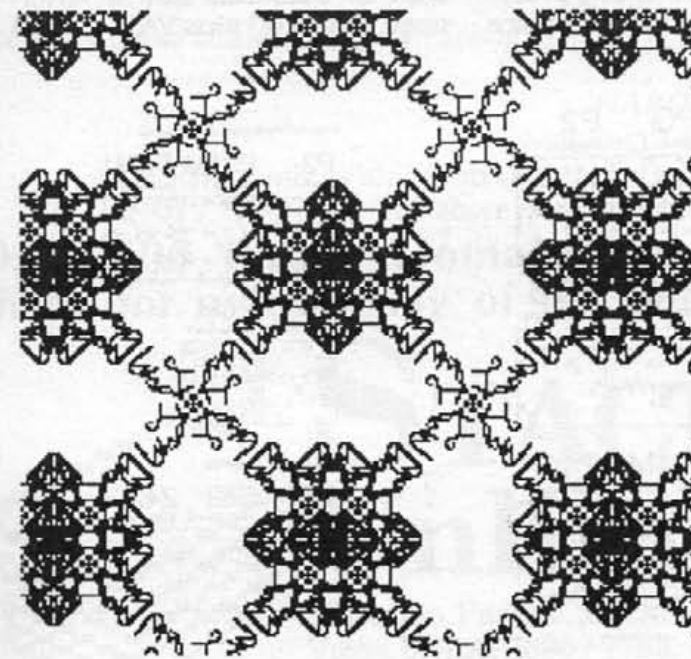
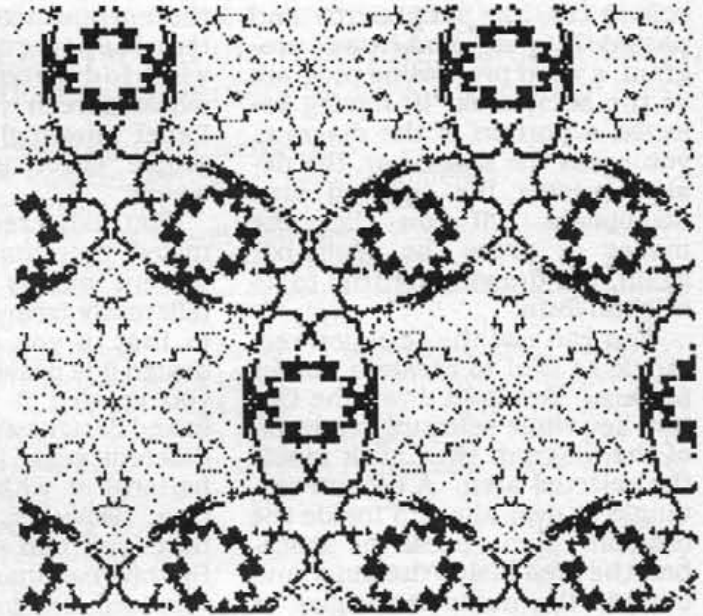
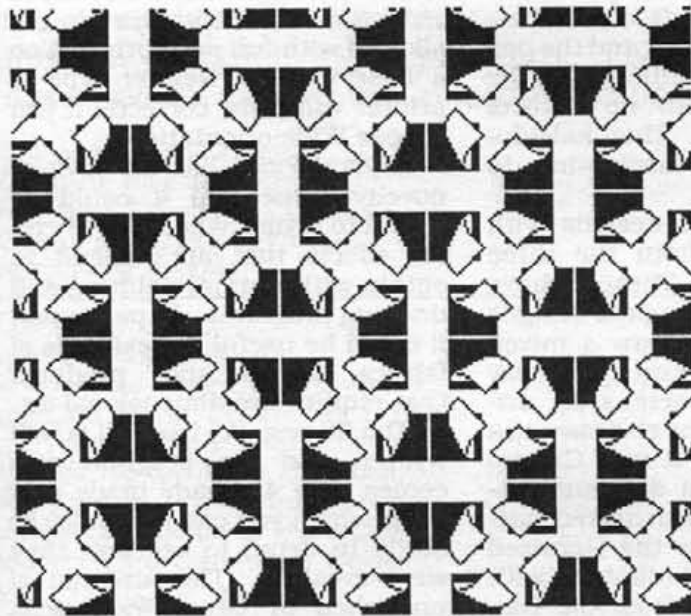
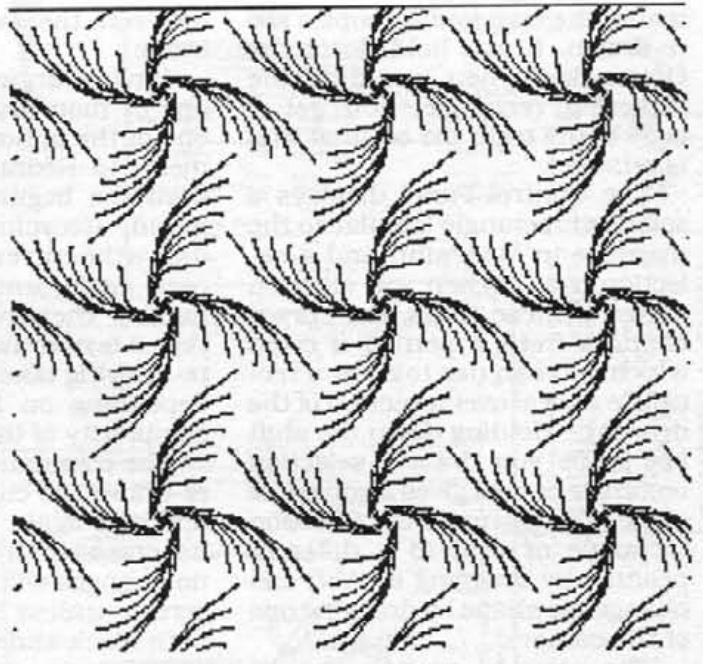

mand) the trail and its copies are re-drawn. If you hold down the Option key when you drag the flickering rectangle, you get a copy of the trail; the original trail is retained.

The Control Panel displays a selection rectangle (similar to the marquee in MacPaint) and a selection oval. When you click on either of these icons, the cursor changes from a pen to a cross which you can use to draw a rectangle or oval over a section of the drawing. Holding down the shift key while you draw a selection rectangle or oval gives a square or circle. You can move the selection rectangle or oval to a different position by dragging it. You can change the shape by dragging one of the corners.

The selected section can be copied to the clipboard and pasted into a paint/draw program, a word processing program or the scrapbook. If, having selected a portion of the diagram, you press the space-bar, the design outside the selected area disappears. If you click the mouse or press the space-bar again, the drawing returns to its original form.

You can use the selection rectangle or oval to create a border pattern. You hold down the Option key while selecting a portion of the diagram then click inside the selected area. A second rectangle or oval appears inside the original. If you press the space-bar, the area inside the inner and outside the outer rectangles or ovals is blanked out, leaving your design on the screen as a border

between the two rectangles or ovals.

Having drawn a design with one or more trails, you can use one of the options in the Display menu to Redraw All the design from the beginning. The command Recycling Redraw, re-draws the current design over and over again until you click the mouse. The screen is erased each time it is re-drawn. The process of re-drawing takes several seconds depending on the number and complexity of the trails.

The command Recycling Draw re-draws the current design over and over again but the screen is not erased each time. In this case, no changes will be visible on the screen unless the design uses both black and white pens.

The command Autopilot uses the current settings of the pattern, the paper colour and the pen width to draw continuously on the whole screen (with no Control Panel showing). This kaleidoscopic effect is fascinating to watch.

You can create designs with mixed patterns from the three pattern menus. These behave differently from unmixed designs in that, if you re-draw a mixed design it is drawn exactly the way you created it whereas an unmixed design can be re-drawn to a different scale (if it is a Crystal pattern) or with a different pattern. However, with mixed patterns you can use the Unmixed Redraw command (dimmed with unmixed designs) from the Display menu. This re-draws everything in the pattern of your choice

but warns that you will lose the original drawing unless you have already saved it.

You can paste a picture from a draw or paint program into Crystal Paint. If you have chosen any pattern other than C1, it makes two or more copies of the picture in the style of the current pattern.

There are two ways to print your Crystal paint designs. The Print Drawing command in the File menu prints everything visible in the drawing rectangle. The Print Full Page command fills almost the whole of a sheet of A4 (assuming you have chosen A4 rather than US Letter with the Page Setup command). You can use either an ImageWriter or a LaserWriter but with an ImageWriter, you cannot choose the 50 per cent reduction. Both reduction and magnification are allowed with full page printing on a LaserWriter. Neither type of printer will print correctly if you choose Wide orientation.

Crystal Paint has an obvious novelty value and it could be useful to artists who want to create effects that are difficult to obtain with normal painting and drawing programs. In particular, it could be useful to designers of fabrics, carpets and products that require two dimensional art.

The 56 page A5 manual is well written and the program disc comes with 43 ready made patterns which you can just enjoy or study in detail to see how they were created. The program is published by Great Wave Software of California and is advertised at £39.00 plus VAT.

Central Patterns

Figure 2

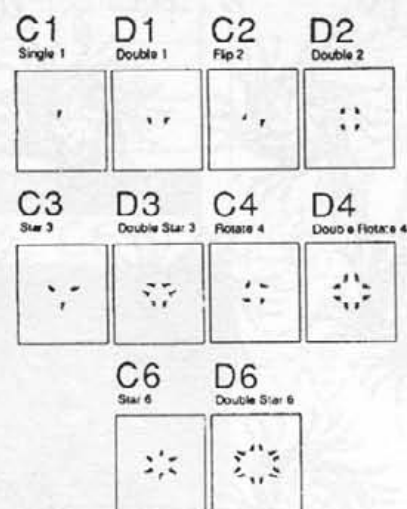

Crystal Patterns

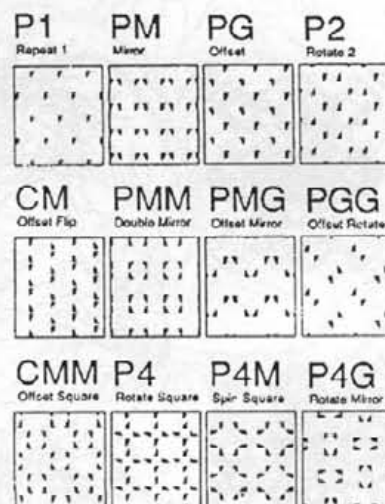

Crystal Patterns (continued)

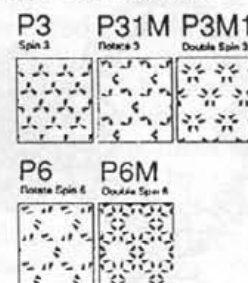

Conformal Patterns

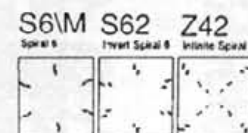

Reports!

The complete Report Generator for HyperCard only £79.99

inc VAT, Postage & Packing

Michael Dark Studios
Accounts Receivable as of 07/27/87
Prepared by Dana J. Andrews

Legend: Second Notices are sent at 30 days
Third Notices are sent at 60 days
Final Notices are sent at 90 days.

Stack: Accounts Receivable Sorted by Month of Invoice Date, Last Name, and Invoice #

CLST #	INVOICE DATE	INV #	CUSTOMER NAME	PHONE #	TOTAL INVOICE	BALANCE DUE	AGE
1001	03/04/87	4106	Epperson, Hugh	317-881-1234	\$ 212.50	\$ 182.50	143
1001	04/12/87	4106	Epperson, Hugh	317-881-1234	\$ 185.00	\$ 185.00	144
1001	04/25/87	4107	Epperson, Hugh	317-881-1234	\$ 212.50	\$ 212.50	145
1000	04/11/87	4114	McIntosh, Paul	317-283-8978	\$ 405.00	\$ 405.00	144
Total For Month 04					\$ 802.50	\$ 802.50	
Average For Month 04					\$ 267.50	\$ 267.50	141
1129	01/03/87	3323	Brown, David	317-881-7511	\$ 157.50	\$ 157.50	88
1001	03/30/87	4184	Epperson, Hugh	317-881-1234	\$ 450.00	\$ 450.00	74
					\$ 183.00	\$ 183.00	89
					\$ 900.00	\$ 900.00	75
					\$ 240.00	\$ 240.00	61
					\$ 540.00	\$ 540.00	58
					\$ 80.00	\$ 80.00	81
					\$ 2500.00	\$ 2500.00	
					\$ 322.50	\$ 288.13	72
					\$ 45.00	\$ 45.00	84
					\$ 812.50	\$ 812.50	20
					\$ 240.00	\$ 180.00	54
					\$ 287.50	\$ 287.50	34
					\$ 294.00	\$ 294.00	42
					\$ 212.50	\$ 212.50	86
					\$ 212.50	\$ 212.50	38
					\$ 812.50	\$ 812.50	36
					\$ 185.00	\$ 185.00	24
					\$ 685.00	\$ 685.00	37
					\$ 102.50	\$ 102.50	33

Michael Dark Studios
Pay Date: 03/06/87 Exp # 2041 Employee: Marsha Mason 1958

DESCRIPTION	AMOUNT	DATE	DESCRIPTION	AMOUNT	DATE
GROSS PAY	\$ 2,237.00	7/27/87	FEDERAL TAX	\$ 229.00	
FICA	\$ 138.00		STATE TAX	\$ 107.00	
NET INCOME	\$ 1,870.00				

Michael Dark Studios
MARSHA MASON
317-881-1234
7/15/87 \$ 227.12

Until now HyperCard's printing has been limited to screen dumps, single card data dumps or complete stack printouts. HyperCard lacked the reporting feature that allows you to exploit the awesome information management power it incorporates.

- Row and Column Reports
- Complete Inventory Reports
- Free-Form Reports
- Checks and Check Registers
- Accounting Reports

- Address List, Labels, Cards
- Invoices, Receipts, Purchase Orders
- Project Lists
- Form Letters with Mail Merge
- Requires HyperCard Version 1.1

BOOKS

HyperTalk Programming	£18.95
The Complete HyperCard Handbook	£27.95
HyperCard Power Techniques & Scripts	£15.50
HyperTalk and the External Commands	£9.95
Windoids 1-6 (by Apple Computer)	£3.50
Understanding HyperCard	£23.95
Quick & Easy Guide to HyperCard	£12.95
The HyperCard Developers Guide	£27.95
Inside HyperCard	£18.95
Hyper Dictionary	£12.95
XCMD & XFMD5	£30.00

The above prices include Postage & Packing

COMMERCIAL STACKS

Focal Point	£79.99	Business Class	£44.95
HyperDA	£49.95	HyperTutor	£44.95
City to City	£44.95	Script Expert	£59.95
Icon Factory	£34.95	Reports	£79.99
HyperAtlas	£79.99	HyperTools Vol 1	£79.99
Amanda Stories Vol 1	£19.95		
Amanda Stories Vol 2	£19.95		
Typography & Page Design	£39.95		
HyperTools Vol 2	£79.99		
VideoWorks Driver	£79.99		
PD ROM	£109.99		
The Nutrition Stack	£44.95		

The above prices include VAT, Postage & Packing

HARDWARE

MacRecorder £175.99

miniQisk 20mb (with 10mb of Public Domain and Shareware Stacks Free) £497.00

The above prices include VAT, Postage & Packing

Over 500 Public Domain and Shareware Stacks

Phone for a free copy of the only European HyperCard Magazine

STACKWARE Unlimited



8 Station Parade, Barking, Essex IG11 8DN.

Voice: 01-594 7330 / 7783. Fax 01-594 9278

Stackware is a Trade Mark of Stackware Unlimited.

ALWAYS THE LATEST
HYPERCARD PRODUCTS

Ancient Art of War

Ceri Fisher reviews this game of strategy for the Macintosh

I was anticipating this game very eagerly. Nice box, nice pictures of miniature Chinese soldiers lunging across the Ming porcelain, classy, spiral-bound manual and plenty of promises. But it is just a game. It couldn't possibly be taken seriously, even in junior school history lessons, which is a pity. Let's see why ...



As I've said, this game comes very well-presented. The first screen shows a cartoon battle in progress, and plays a merry little martial tune. You pull down Game -> Go to War. You choose the battle you wish to fight from the scroll which appears, and the next scroll gives you a background story. Then another scroll shows the 'rules of combat', for example:

- Villages supply food
- Forts don't supply food
- Supply line is long
- Your men are in good shape
- Enemy is seen always
- Water is deep but calm
- Mountain is high but safe (this was the default for action in Sherwood Forest - no kidding!)
- Forest is dense.

You can change any of number of these to their "opposites" (or there may be three or four different possibilities).

Next you choose your opponent

from a gallery of pictures. As you browse (mouse-wise) this collection of military genius, each character is summarised for you on the screen. As with the rest of the game, there is a lot of excellent help in the manual, and just enough to keep you clued-up in the Help pulldown menu which is always available.

Here are the choices:

- **Athena** (the Greek goddess). Her strategy is fairly simple and based on the battle against the Titans. I don't quite see a connection between this and human warfare, but then I didn't know there were mountains in Nottinghamshire!
- **Alexander the Great** (the Greek general and conqueror).
- **Geronimo** (the Apache Indian chief who beat Custer).
- **Crazy Ivan**. The manual assures me he was a real character in American mythology (so he must be on a par with Athena in authenticity). I think he's here just to support the inclusion of a random (i.e. goal-less) strategist. He certainly is the easiest to beat.
- **Julius Caesar**. Needs no introduction by me. Et tu, Bröderbund?
- **Genghis Khan**, and his right-hand man, Subotai.
- **Napoleon**.
- **Sun Tzu** himself.



THE ANCIENT ART OF WAR

Having picked him (her), you get a little advice from Sun Tzu (something like: "a hot temper leads to ridicule" Ah, so!).

Then, with another little fanfare, battle begins. Or at least, the

campaign does, and this is what it looks like:

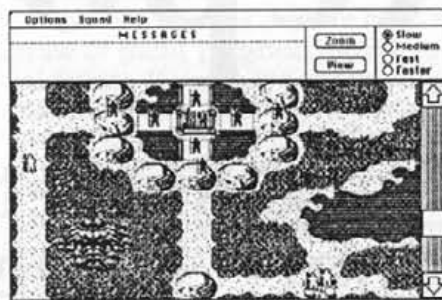

Options - lets you save, surrender, or continue.

Squad refers to the individual "units" on-screen: you select one with the mouse, and then you can give it its marching orders by dragging the mouse to the destination.

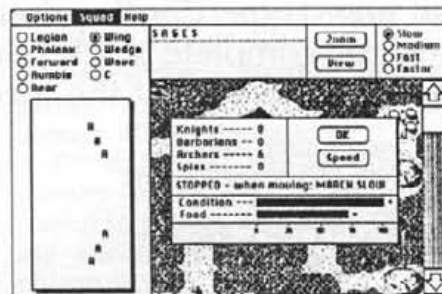

One problem with this was that if you dragged close to the top or bottom of the screen, the screen scrolled (fine) and the squad kept on moving - so you could easily drop them in the sea or somewhere equally irrelevant, and they would trace out that path exactly. Oh, oh! So you have to try again.

Also, since the squads are composed of a number of fighting men, you can alter their speed of progress, or move individuals between units (or make a new unit) using "detach" and "join". Actually, you couldn't always do this, and I couldn't see why not. You can also change their formation for marching and fighting (wing, wedge, phalanx, 'C', etc.) as well as devise new formations (elsewhere in the game).

I'll come to the "zoom" button later. The "view" button shows two thumbnail sketch maps - one summarises the whole terrain, and the other tries to show the concentrations of military power, but not very accurately - about 10 squares by 20.

The message panel posts things like "Enemy spotted in the north",

"Encounter in the interior", "Fighting in the east", etc. The last two mean that you can "zoom" in to the action.

Finally, the radio buttons control the rate of play of the game - i.e., how fast is fast?

The action in question is taking place in "Sherwood Forest", and we (the goodies) are in white, trying to seize the enemy's (black) flag from his castle, while defending our own white flag.

I planned to stage a decoy to the north of the castle, to draw out some of the defenders, and then rush in from the east and west. I needn't have bothered! Since my opponent was Crazy Ivan, he sent out most of his defenders to try to get my flag, so my decoy and the rest of the attackers went in, and I followed them with the "zoom" button...

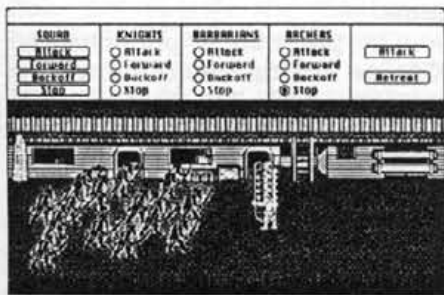

I think this screen was my major disappointment. These little figures strut across the screen just like robots, and you can intervene

with appropriate orders - usually to get your guys to back off if they're outnumbered, and so avoid a thrashing. If you had mixed squads, then you can get different kinds of fighter to do different things. Fine. But, I think the outcomes are very arbitrarily decided - many times archers totally failed to fell their targets, but then were knocked out themselves while the enemy was still some distance away (that's right, just fall down dead!). Come on! I guess this style is all the rage in arcade games, and it's maybe what the kids want - but do the kids have Macintoshes?!

To cut a long story short, I sent in wave after wave of archers, and eventually got the flag. Wonderful! There's a message posted to that effect, and a new screen that says you won, or something, but I didn't really feel I'd done anything.

And you can build your own maps, write your own campaigns, and generally re-write any part of history you want to. But...

I think really that they (Brøderbund) just don't know who to aim this at. Maybe (maybe, I didn't try it like I did Apache Strike) this one will keep the kids (5-10 years) amused all Saturday. But I'm not sure if they'll "learn" anything much from it - nothing general or applicable elsewhere, anyway. And they're probably not going to give the manual and the "strate-

tics" the attention they deserve.

In fact, the manual is an interesting read. It does compress a handy amount of information about warfare through the ages into a fairly small space, and it reinforces the impression that a lot of thought went into the overall concepts of the game.

For kids of other ages, those are the best aspects of it, and one could possibly get a bit involved in them - but the other shortcomings would get in the way. Also, trying to cover 2000 years of military history with one "wargame kit" is a bit ambitious - and it doesn't come off. While I'm sure that Sun Tzu would have been quite at home at Waterloo, I think he would have wanted cannon and cavalry!

info

Product: Ancient Art of War

Publisher: StyleWare Inc

Available from:

MacLine

01 642 4242

(See page 73)

Price: £ 29.00

(+ P&P + VAT)

Value:

Performance:

Documentation:

News from the States

Following the success of their Desktop Presentations package, Cricket Software introduced their latest development Cricket Paint (a mono-chrome paint program) at Boston MacWorld '88.

The program offers many tools, including a pattern / Texture tool; graded tints, with the ability to define up to 64 patterns; darken and lighten commands for shading and contrasts.

Special effects can be created with a reshaping Ellipse tool or one of four Polygon tools. Transformation tools include distortion, perspective, reshaping and free rotation.

Cricket Paint images can be created at resolutions ranging from 72 to 300 dpi and output to Apple ImageWriter and LaserWriter printers.

The program imports MacPaint, TIFF, PICT and PICT2 formats and saves them in Cricket Paint, Mac Paint and PICT formats.

Cricket Paint runs on a Mac Plus, SE and Mac II, and is available from Hayden and Son.

Dow Jones & company, Inc. has exercised an option to purchase a 19% interest in Solutions Inc., a Vermont base software developer.

Solutions Inc. was founded by current president Tom Evslin in 1970. During the 1970's, it developed the first mainframe software to link banks to automated clearing houses for the exchange of paperless transactions such as direct deposit of Social Security payments.

During the 1980's, Solutions Inc. has specialized in the development of microcomputer software, particularly for the Apple Macintosh. The company's graphic utility package for the Macintosh, SmartScrap & the Clipper, won MacUser Magazine's Eddy award for best new Desk Accessory of 1987 and is currently second on the software distributor Softsel's best seller list for Macintosh utilities.

Dow Jones publishes The Wall Street Journal and other periodicals, electronic business information services and community newspapers. It also owns 56% of Telerate Inc., which provides computerized financial information on global markets.

QuickDex & MacList

Two desk accessories reviewed by Geoff Wood

QuickDex and MacList are desk accessories which give fast access to simple databases such as lists of names, addresses, telephone numbers and similar information. Neither of them will run in a 128k Macintosh.

The advantage claimed for having a database as a desk accessory is that you can use it to copy and paste a name and address into a letter or, if the phone rings when you are running a program and the caller says "Hello, this is Joe Bloggs.....", you can look up details about him and make notes about the current conversation.

However, you could just as easily keep names and addresses in a word processor file (or in the database in Microsoft Works) for transfer to a letter and you could keep a card index or book to look up details of callers.

Installation is simple. Both programs come with a Font/DA Mover on the disk but only MacList warns you to use the version that matches your System.



QuickDex is a 29K program that simulates a Rolodex card system. Each card holds up to 11 lines with about 50 characters per line

but with a maximum of 512 characters per card. You can have as many cards in a file as memory will allow but you can only see one card on the screen at a time.

You can have up to eight 'decks' (files) of cards open at the same time and see parts of cards under the topmost card in the active file. You can switch to another file either by clicking on an exposed card (the file name is at the top of

the card) or by choosing the file name from the menu.

When you invoke QuickDex, it re-opens the file that was used last time and it can remember the location of other files. The QuickDex menu is headed by an inverted question mark. There are options to Open a New or existing card deck and to Save, Save as or Close a card deck. The menu also offers options to Add a new card, Delete a card or Print a card. All these options have shortcuts such as Command-N and Command-P.

With a file open, you can quickly find any card by typing all or part of a word in the Find box above the card currently displayed. When you press Return, the first card containing the word or part word is displayed. You can press Return again to find the next card containing the word or part word. If the Find box is empty when you press Return, the next card in sequence is displayed; Shift-Return displays the previous card.

QuickDex does not allow you to sort the cards (except when printing) so they appear in the order of entry. You can 'move' a card by copying its contents to the clipboard, then opening a new card elsewhere in the stack, copying from the clipboard and deleting the old card but this is a laborious process.

QuickDex comes with a separate program called PrintDex which allows you to print a complete deck of cards (or new cards only) and to sort the cards on either the first or last word of the first line before printing. You can select a page size to give, say, four cards on an A4 page or you can print directly on to Rolodex forms on pinfeed stock.

A special feature of QuickDex is that you can 'mark' one or more words on a card with a 'bullet' • (Option-8) or another mark of your choice. When you print the deck, it prints an extra card for each marked word and it sorts the extra cards into alphabetical order. So if you mark the city in a name and address list, it prints each card twice, sorted by city and, say, by surname.

QuickDex files are simple text files with carriage returns at the end of each line and an asterisk at the end of each card so you can easily convert most word processor files into QuickDex files and vice versa.

QuickDex can also dial the telephone number on any card through a Hayes modem but not having a modem I was unable to test this feature. It may not be suitable for British phone systems.

The program is published by Greene Inc of California and is advertised at £37.00 plus VAT. The 20 page A5 size manual is not well written but gives all the information you need. It claims that the product was extensively tested before being released but is not guaranteed to be 100 per cent bug free. I had no problems with it.

MacList is a 43K program which is much more akin to the database in Microsoft Works or spreadsheets such as Excel.

It displays a list of records where each record is a row and each field is a column of the list. Up to 15 records can be displayed on a Mac Plus or SE screen. Any column can be widened to fill the window or narrowed down to a minimum of two characters. Scroll bars alongside and underneath the window allow you to scroll through the records or see data in other columns.

The MacList menu offers options to Open a New or existing file and to Save, Save as or Print a file (or a selection of records). Other options allow you to Insert or Delete a row or column or to set the Format of a column (numeric or text, aligned left, right or centre). There are shortcuts for most options.

MacList only allows one file to be open at a time but you can copy and paste records between files, provided that they have the same

number of fields.

Like QuickDex, MacList can search for a word or the first part of a word but you must search in the right field. It can do combined searches, e.g., from a list of restaurants classified by type and location, it could select all the Chinese restaurants in a given city.

Unlike QuickDex, MacList can sort its records into alphabetical or numerical order. It can sort on up to three fields, e.g., name of restaurant, type and city.

The MacList menu includes commands to Import or Export data from and to other programs. A MacList file is a text file with tabs between the columns and returns at the end of each row. You can use the Copy and Paste commands to transfer part of a list from and to MacList.

The 35 page A4 sized manual does not specify the maximum number of fields per record nor the maximum number of characters per field nor the maximum number of records per file. I tried to create a file with twenty fields per record but when I moved the horizontal scroll box back to the

left, the system hung on my Mac Plus. I tried again several times with as few as ten fields but the same thing happened.

I did not look for any more bugs, this one was enough for me. I cannot recommend MacList but it is shareware from JAM Software Pty so you can try before you pay though no price is given. The shareware registration form is written in Word 3.

Also on the same disc is a desk accessory called Convert which

converts metric measures to Imperial and vice versa. It deals with linear, square and cubic measures including both US and UK gallons and it also does Fahrenheit/Celcius conversions. The shareware price is \$A20.

Personally, I prefer not to clutter up my system with novel desk accessories, especially if they are shareware, but if you are a desk accessory enthusiast, these programs might appeal to you. 🍏

info

Product: QuickDEX™

Publisher: Greene Inc

Available from:

MacLine
Wren House
Sutton Court Rd
Sutton
Surrey SM1 4TL

Price: £ 37.00 + VAT

Value: 🍏🍏🍏

Performance: 🍏🍏🍏

Documentation: 🍏🍏🍏🍏

info

Product: MacList™

Publisher: Jam Software

Available from:

Jam Software
685 Market Street
Suite 860
San Francisco
C A 94105

Price: Shareware \$20

Value: 🍏🍏🍏

Performance: 🍏

Documentation: 🍏🍏🍏



Chameleon Software



Apple Specialists

SONY Branded Disks

3.5" DS/DD (box of 10) £12

5.25" DS/DD (box of 10) £ 9

Disk Boxes

Antistatic, hinged, lockable.

3.5" 70 Capacity £8.50

5.25" 100 Capacity £9.50

Games for Xmas!

How about treating yourself to.....

Amnesia	£25
Bard's Tale II	£25
Bard's Tale III	£25
Deathlord	£24
Force 7	£17
Legacy of the Ancients	£25
Movie Monster (128k)	£17
Sub Battle Simulator (II/IIIS)	£20
Wasteland	£25

'ALL PRICES PLUS VAT'

Trade in your old software for new! Originals only please!

Tel:

0775 85481

Cuckoo Lane, Pinchbeck, Spalding, Lincs.

PE11 3XT

Open Mon to Fri:

9am to 8pm &

9am to 5pm

Sat

Ring today! Order with ACCESS the easy way!

MacWrite Version 5 £60 (While stocks last)

Macintosh Second User Special Offers:

Macintosh HL/Lisa with 1Mb RAM, 10Mb internal hard disk,

Pascal Workshop, MacWorks, ImageWriter II lead and MacWrite.

ALL FOR ONLY £695

Printshop Mac £20

New for the Macintosh:

Dark Castle £23

Enchanted Sceptres £25

Radius A4 Screen (Mac +,SE,II) £995

Radius A3 Screen (Mac SE,II) £1495

Thunderscan Mac (Scanner) £185

Read It £220

Ring or write for a full list, we supply it all!

Double Helix II

Bill Pearce reviews the relational database from Odesta Corporation

Double Helix II is an entirely icon-based relational database generator. Icons are used to store every detail of the file format, while windows control all the views and most of the operations performed on the data. Fig 1 shows how data types are defined while fig 2 illustrates the formatting of a number. It is also possible to enter a validation formula to ensure that only acceptable data are entered.

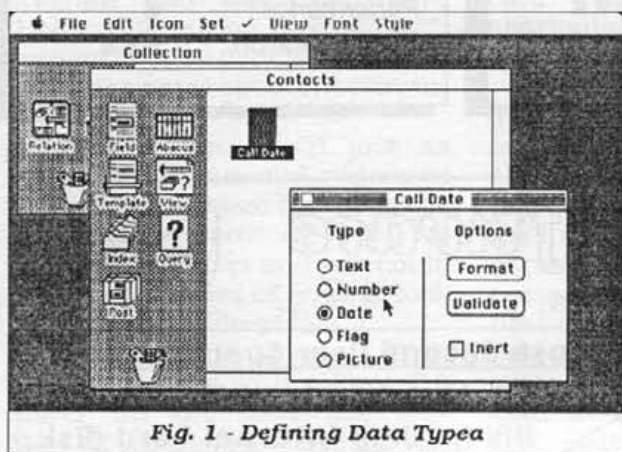

Fig. 1 - Defining Data Types

There are so many clever features in Double Helix it is almost worth buying for the fun of playing with it. Do not be put off by the 'icons for everything' philosophy. It takes only minutes to associate an icon with its function.

'About Helix' on the Apple menu is the most eye-catching I have seen. Also on the Apple menu is a Get Info that lists current collection size (collection = database), space available on all mounted volumes, current user name and multi-user information. Help, or Custom Help, is available if the icon is on any mounted volume. The Help file (fig 3) is so complete it almost replaces the Manual, yet it does not duplicate it. Custom Help allows the programmer to

create customised help files for an application. There are many thoughtful touches. If disk space is running low, the cursor will begin to flicker. Many long operations may be interrupted by Command Period. These operations are signaled by the cursor changing to the cloverleaf character. Whenever you attempt a disallowed edit operation there is a BEEP and the Apple menu 'Why?' becomes active. Select 'Why?' to

bring up a message box that explains exactly why that particular action was disallowed - usually incompatibility of data types, or something is in use and cannot be thrown away. Helix house-keeping is such that whenever possible it will iron out incompatibilities.

A good database generator may tell you that you do not need programming skills in order to use it. Double Helix is such a one. This is the spider talking to the fly. True it can take care of many logical and all syntactical and compatibility problems for you. In the matter of compatibility it is foolproof. The entire database is one compact piece of code, so that there can never be incompatibility between formats and data. Amazingly, character field length does

not have to be defined, which avoids wastage of storage space, and up to 32K of characters are allowed. Maximum flexibility is maintained for editing existing data structures. If a change will affect existing data, you are warned that data will have to be thrown away, but the decision is yours. I did not succeed in creating any situation where Helix failed to take appropriate action: no freeze-ups, no crashes.

It is so designed as to allow a beginner to get a long way in a short time, particularly if only a flat file is needed. There is a 32 page 'Quick Start' pamphlet, well illustrated and explained, that you can flip through and execute almost as fast as you can turn the pages (fig 4). It is so easy to grasp the idea that you could adapt it at sight to your own purposes and create your own database, with pictures if they happened to be in the scrapbook, within minutes. In addition to the 'Quickstart' there is also provision for automatic generation of a Quick Entry form or a Quick List form. The Quick Entry form displays all the fields in a column, labeled, in the order in which they were last selected, and awaiting editing record by record. The Quick List form lists all the fields in a horizontal row in the order in which they were last selected and lists each record in a vertical column. This form is not editable. Fig 5 shows an example of each of these forms.

Unfortunately there is no Quick Manual Assembly. It took me an hour to assemble the manuals. I am by nature cautious and did not assume that machine or person would have correctly collated the pages. For all this caution I failed to notice that there was a

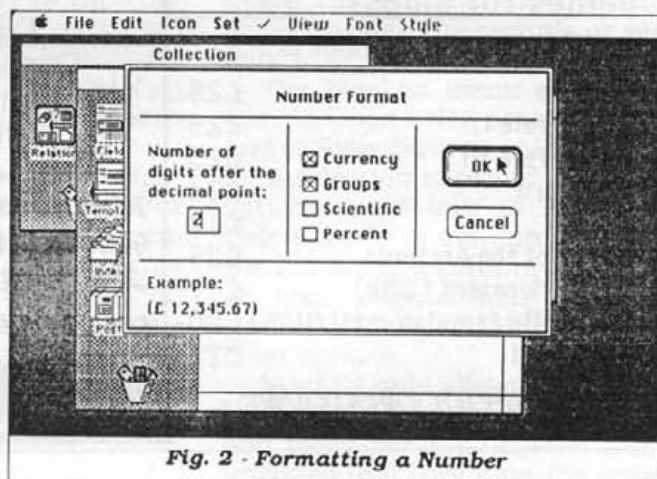

Fig. 2 - Formatting a Number

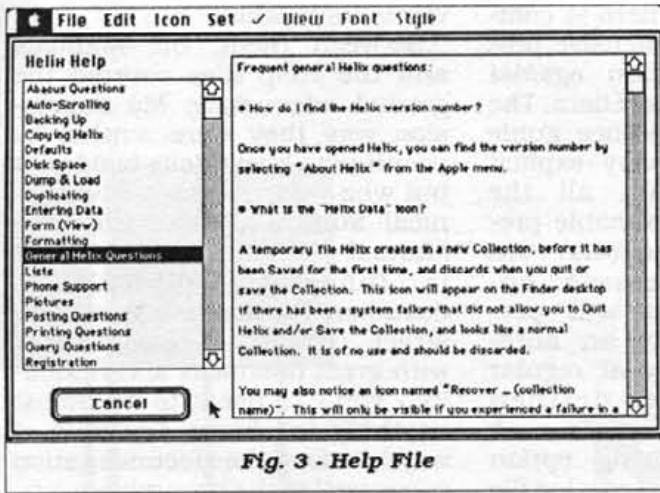

Fig. 3 - Help File

second index at the back of the 'User's Guide' which was actually an index to the 'Reference Manual'. The ensuing pantomime would have made a good 'Candid Camera' sequence. One minute the references were perfect: the next they were all wrong.

There are several useful sample programs on disk, all suitable for expansion. Fig 6 shows the most thoroughly worked one which is given in various stages of development - designed to show off some of the more sophisticated relational and graphical capabilities of Helix.

Apart from viewing the samples, I wasted no time testing the routines explained in the manual. Helix has been around long enough to have got the act together. What about the things it doesn't explain? There were one or two ideas I wanted to try. This screen (fig 7) illustrates one. It was operational within hours of starting Helix. There is a main record that includes current salary. Wanted, an expandable subfile to store salary history. History records may be required for many purposes. VWSTF is a

main record. The operation that transfers the information is called 'Posting'. Any edited or posted information is immediately reflected throughout the system and will show up on any screen where it appears, even in multi-user mode.

Now, the next problem that I wanted to solve was how to perform a simple global update: e.g. increment all prices or all salaries by x% or £xx. The manual points out that this is an obvious use for posting - but no global update is illustrated or demonstrated. It should have been the work of a few minutes as the route seemed obvious. After days of failed attempts I wrote to Odesta for help. (There is a help phone number for registered users.) The printed reply was quick and explicit with

specially designed view of the main records that allows a search for the required record. The salary history record, which stores only the unique staff no. and the salary information, can then be created. This automatically updates the current salary in the

efforts. I have not therefore been able to try the next exercise I had set myself which was to tack on the end of a global update the creation of the attendant history records (the point being to access another file during posting).

There are drawbacks inherent to the Helix approach. When defining the file formats, calculations, templates and views, the multiplicity of icons on the screen becomes very confusing. There is no shortcut to discovering what is on the screen or where it is. Even more irritating is the fag of opening up an icon to confirm what is inside - particularly the abacus (calculation) icons (fig 8). They pose another scrolling problem. An abacus 'tile' has three movable parts. They may be fun to play with, but positioning them so that you can follow the logic of a calculation (especially when you

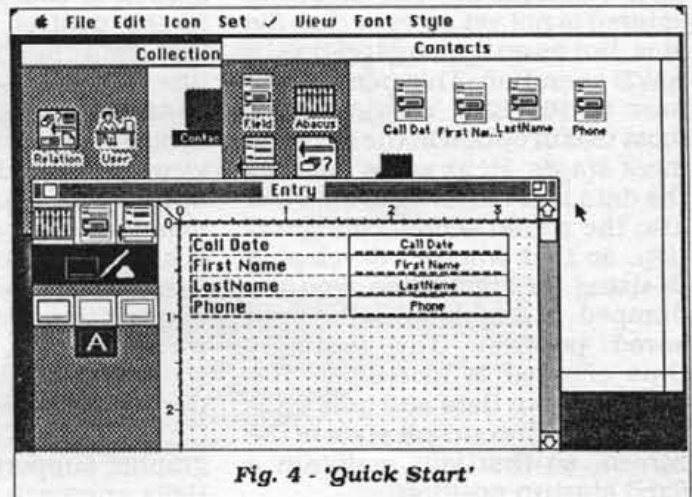

Fig. 4 - 'Quick Start'

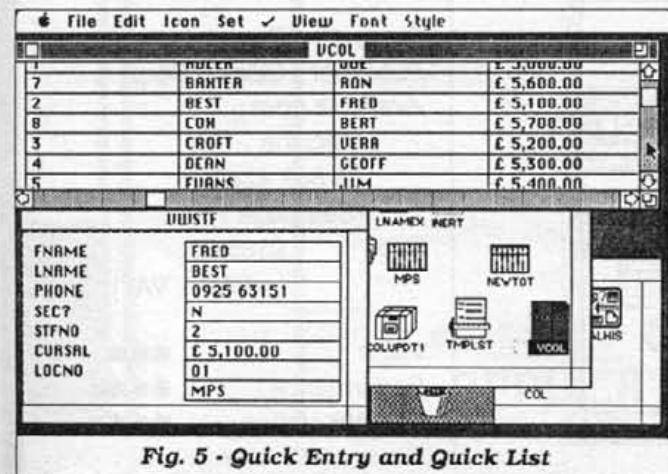

Fig. 5 - Quick Entry and Quick List

change your mind, or when the calculation is more than a screenful, which is often the case), becomes a clumsy operation. Hence my reference to the spider and the fly. After an hour or so trying a few calculations you long for the simplicity and compactness of a simple verbal formula. Anyone who can cope with the logical relations covered by these files would have no trouble at all coping with some elementary syntax. I do agree with the principle of offering fixed formulae for selection, but I feel that a scrolling text window as used for the help file would have resulted in a more manipulable system. In view of the above problems, it clearly pays to keep copious notes of how everything is supposed to work: you cannot simply ask for a listing in order to view

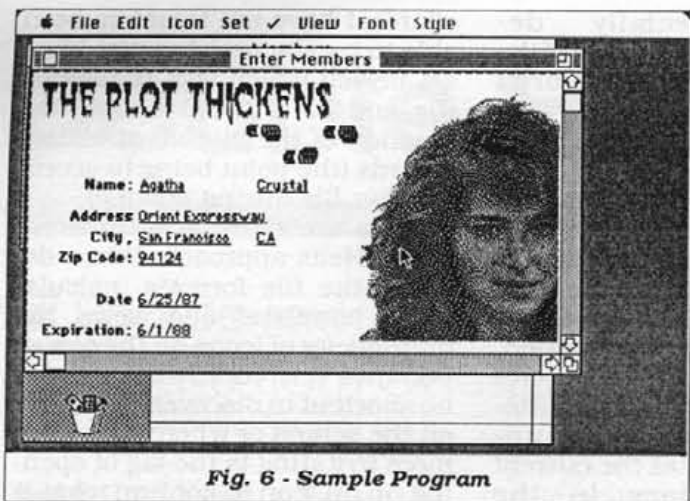

Fig. 6 - Sample Program

your handwork!

When an application is running, you will normally require a multiplicity of windows. As a general principle, a window is required for each operation. An active window invites editing and an entered record always brings up the next record. The data thus entered is not yet on your disk file (it is, but as an appendage) until a SAVE operation. This permits the user to REVERT TO SAVED, a most useful option in the development stages. Helix saves not only the data and file formats etc., but also the actual screen configuration, so that whether developing or using an application, you are dumped straight into the last saved position. The flexibility thus afforded is incredible. You can save your data and quit without saving the current state of the screen, so that you maintain a fixed startup position.

View windows also cater for reports, searches, posting information to other files, dumping formatted information for picking up in other applications.

that rescues all but the last transaction, and sometimes even that one.

The Odesta team clearly excel in disk management and control of

the Macintosh interface. Of far greater concern to a user, of course, is the control of the data in the files and the ease of setting up that control. My final view is that despite the undoubted flexibility of its relational capabilities, the reliance on icons and windows leads to somewhat clumsy data handling.

Only for data files needing graphic support would I feel the Helix approach justified.

Supposedly a hard disk is necessary to cope with the size of HELIX (605K). I experienced no difficulty using a MacPlus with an external drive. There is a 400K

There is comprehensive protection against loss of data. The reference guide is very explicit about all the reasonable precautions. An Autosave option will perform an auto-save at regular user-defined intervals. A Logging option creates a log file

version available.

Between them, the Manuals and the Help files covered the ground adequately. My impression was they were written by people who knew Helix inside out but who were not primarily technical authors. Quote from the Manual - 'The Helix environment is inherently difficult to document because it is an abstract conceptual environment with great openness and flexibility - you can use it to do almost anything in almost any kind of way.' In fact the documentation copes well with this problem (viz. organising the information), but some explanations were imprecise. Definitions of one-to-many and many-to-many relationships bordered on self-contradiction. At

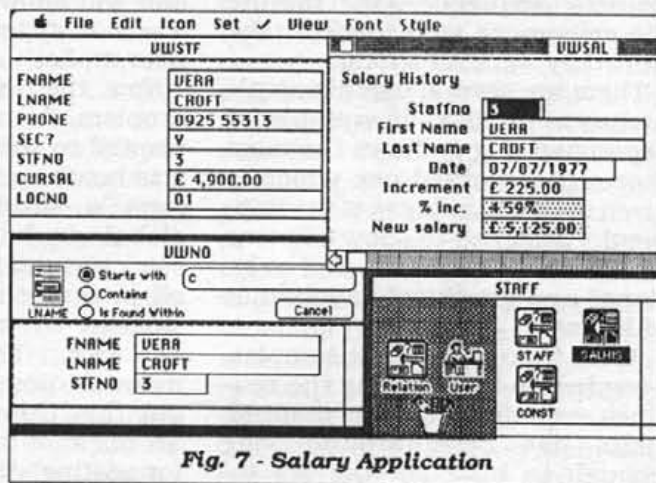

Fig. 7 - Salary Application

least a valiant attempt is made to cover the basic principles of databases. The assessment I offer is of necessity personal but I hope that there is enough information in the review to enable a reader to adjust accordingly.

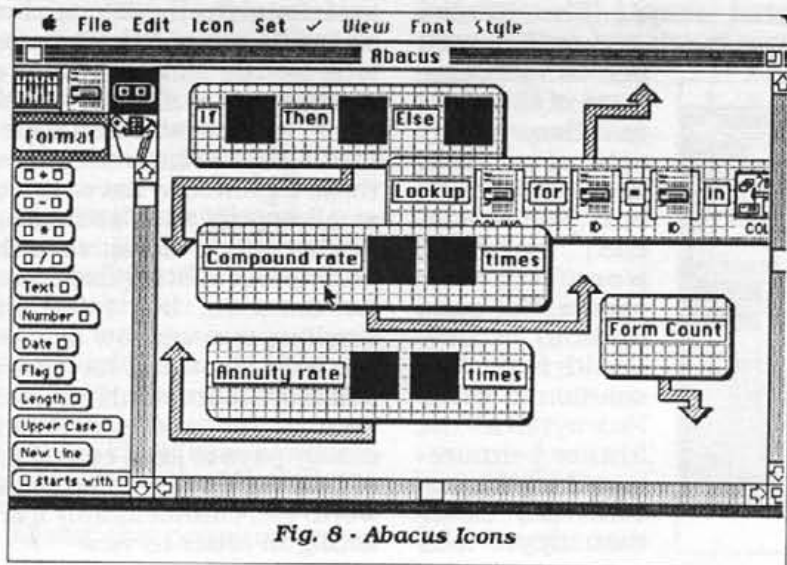





Fig. 8 - Abacus Icons

info

Product : Double Helix II
 Publisher : Odesta Corp.
 Available from :
 MacLine
 01 642 4242
 (See page 73)
 Price : £365.00
 (+ P&P + VAT)

Value : 
 Performance : 
 Documentation : 

**TWO
NATIONS
ONE
PRICE**



apple computer specialists

Tel: 0525 240243

APPLICATION RESEARCH TECHNOLOGY LTD

Crystal Quest

A game for the Macintosh, reviewed
for us by Ceri and Daniel Fisher

Crystal Quest

... starts innocuously enough, with a few screens of inside information on the flora and fauna of the game. Of course, if you're at all impetuous you'll skip all this as soon as you can see how to, and with a "visual effect iris slow" you're into the game. There's a little blob in the middle (that's you), attached to the mouse with what feels like a string of bubble-gum - in other words, you move the mouse and this guy gathers speed off towards the edge. Oops. You jump. Didn't that sound just like someone being mugged next door? You look over the partition. No, he's still asleep. Wait a minute ("visual effect iris slow"). The game's starting over. You grab the mouse. This time, you stop the little critter before he hits the dustbin on the side, swerving into a few of those crystal-shaped

gizmos on the way. (nice DX-7 style zing, zing).

So that's it. You clean up a few more. Uh-oh. Here come the nasties, fluttering around those things at the edge. Last crystal. A door opens at the bottom, and, with the aid of something not quite like gravity, you swoop through. A girl says, "Aahh". (no, really). "Wave 2" begins. This time it's the Mob coming out for you,

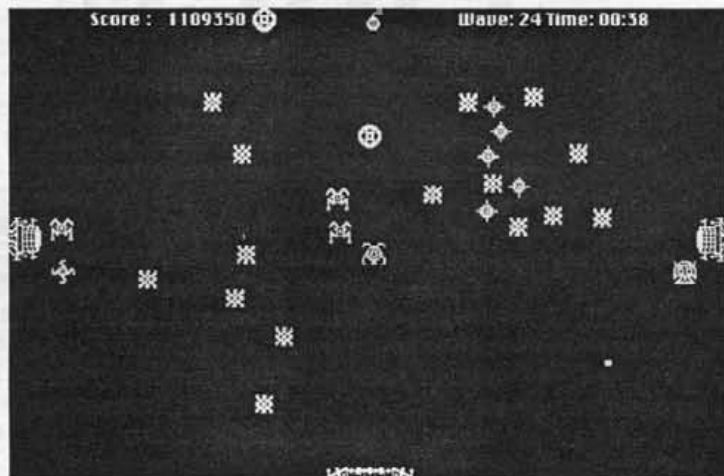

loosing off in your direction, but you're on top. The mouse button fires a shot whichever way you're going. This is real action, OK. "Aahh" sighs the girl. "Wave 3".

Now there are blobs of jelly wobbling towards you, and they don't

die straight away like the other guys; but it sounds like it hurt them pretty bad anyhow. One of them expires with a sound like someone very ill. You skate over a number. "Yeah!" says an admiring voice. You hit something you thought was a crystal (because you didn't look close enough!) Oops. So those things are mines. But you're getting better. "Aahh".

Next all these kooks come on at once! Just in time you remember the "smart bomb", (so, what's so smart about something that works just like an H-bomb?). But it saves your skin. The screen's clear. "Aahh". The next wave are laying mines, with a sound like someone burping "Ey-ooop" (as in "Ey-ooop, lad"). Then there's the flying spiders dropping balls which bounce. "Boing", "Boing-boing". But now you're hooked. "Aahh". Somewhere around wave 21 there are nasties which explode when you hit them, catching you if you're too close. You don't care any more. The phone rings. You take it off the hook. "Aahh".

By-the-way, I played it on a plain Mac Plus - 800K drive, but Greene Inc. will supply it on 400K disks if you send back the original copy-protected disk. Mac II owners with colour monitors (and big audio speakers) should love the colour, rock-solid picture and rich sound. There is even a sample (you can copy) which will let you play for about 2 minutes. Tantalising. But it may free up the Mac for longer at lunchtime! You can't hide it behind your Excel spreadsheets either, as it doesn't really get on with MultiFinder. 🍏



Crystal Quest

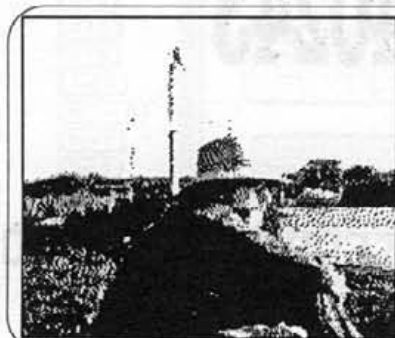

Autobiographical Minutiae:

Ceri Fisher is an AI (artificial intelligence) consultant living in Somerset, England.

He is ably assisted in his reviews of games software by his two-year old son, Daniel, and can be contacted on the UseNET (ceri@euroies.UUCP) or Telecom Gold (72:MAG 90840).

Editors' Note:

This review was completed before the release of Crystal Quest II, which incorporates some new features (including the "Critter Editor"). Available from MacLine (01 642 4242) at £35.00 + P&P + VAT. Crystal Quest II will be reviewed in a future issue.



instant art

IBM
& compatibles

Desktop Publishing Tools

Food and Drink: Detailed bitmap pictures of food & drink; perfect for menus, posters, advertising, books, leaflets etc. (£29)

Gallery: Trademarks, maps, pictures, borders, arrows, geometric shapes and much more stored in bitmap files. (£29)

Hands: Hands are among the most illustrative of graphics and this disc brings together a multitude of different bitmap pictures of hands to illustrate your documents. (£29)

Symbols: Animals, Transport, Agricultural, Industrial, Programming and most of the recommended Tourist Symbols stored in bitmap files.

UK Atlas: UK bitmap outlines with major Cities, Counties, Airports, Railways, Rivers etc. plus London Postal Districts, European map and more. (£29)

Laser Atlas UK: A four 800k disk set of Encapsulated PostScript Files (EPSF) of maps of the UK and Europe. Being in EPSF format they can be resized without loss of quality or detail - ideal for importing into page layout programs. Originals were created in Illustrator '88 and can be modified, shaded etc as required. (£95)

Laser Symbols "Tourism": A downloadable postscript font containing over 200 of the official British Tourist Board Symbols. Ideal for Maps, Brochures, Signs etc. Includes Chemical danger symbols. (£49)

GreyFonts: Allows 9 shades of grey printing of the standard LaserWriter fonts in applications that do not support "greying" of text. (£49 each)

GhostFonts: Allows Light, Medium or Dark Ghost LaserWriter text to be placed as a background (watermark effect) in documents. (£45 for LW Fonts and £89 for LW + & II NT fonts)

Fraction Fonts: Add fractions to your LaserWriter fonts. Option Shift and a number(s) produces the top half of the fraction (2^n), Option Shift / the 'slash' (2^n) and option a number the bottom half (2^n). (£45 for LW Fonts and £89 for LW + & II NT fonts)

To order or obtain sample sheets for any of the Instant Art material call or Fax us on the numbers below

All prices exclude VAT

MacSoft

Bridge House • Wellington • Somerset • TA21 0AA
Tel: 0823-47 3625 or 5834 Fax: 0823-47 3477

HyperCard™ Info

HyperCard Cursors, Functionkeys, Translators and Power User Tips

The following two short articles are reprinted from Resources (Jan 88), the Newsletter of the San Diego Macintosh User Group. They are taken from HyperCard Notes, compiled by Frank Boosman.

Changing Cursors Over Buttons by Frank Boosman

One of the interesting commands I noticed in HyperTalk was the setcursor command, which allows HyperTalk programmers to change the cursor. This is a key feature of Owl's Guide, a hypertext program for the Macintosh, and I thought it would be great to use it in HyperCard stacks.

Unfortunately, I soon discovered that a setcursor command is only temporary – HyperCard sets the cursor back to the standard arrow on every idle, which occurs many times a second. It wasn't until I noticed that Apple's MacWorld stack, created for the Boston MacWorld show, changed the cursor, that I made any progress. It took some serious snooping, but I finally discovered the programming technique the authors of the MacWorld stack used. Here it is for your enjoyment and edification:

```
on mouseWithin
  if "button" is not in the target
  then exit MouseWithin
  set cursor to 29652 – the id of
  the cursor you want
  cursorWithin(the rect of the tar-
  get)
end mouseWithin
```

```
on cursorWithin buttonrect
  put item 1 of buttonrect into left
  put item 2 of buttonrect into top
  put item 3 of buttonrect into
  right
  put item 4 of buttonrect into
  bottom
  repeat while –
  the mouseH > left and –
  the mouseH < right and –
  the mouseV > top and –
  the mouseV < bottom
  if the mouseClick then
    click at the loc of the target
    exit cursorWithin
  end if
end repeat
end cursorWithin
```

As you can see from the listing above, the idea is to handle mouse clicks within your own handler. Once your handlers release control, an idle event will occur and HyperCard will change the cursor. The first handler, mouseWithin, is a card-level handler. It is called as long as the mouse is within any button on the card in question. The mouseWithin handler sets the cursor and calls cursorWithin. The cursorWithin handler retains control until either (1) the mouse leaves the area of the button, or (2)

the mouse button is pressed, in which case the handler fakes a click on the button and relinquishes control.

You can use this general technique in your own stacks. Good luck!

Programming Functionkeys in HyperTalk

By Robin Shank

The HyperTalk command "functionkey" allows you to associate a script with any of the function keys on an extended keyboard. To program a functionkey, use the following format:

```
on functionkey thekey
  if thekey is 5 then
    – add any script
  end if
  if thekey is 6 then
    put the heapSpace – or what-
    ever
  end if
end functionkey
```

You can put the script into a card, background, stack, or home script, depending on how widely you want your functionkeys to be "detected".

The following script will make a functionkey that will automatically move anything selected on the card into the background. The beauty of using type "x" with commandkey instead of domenu "cut" is that it transcends the fact that the Edit menu reflects the object selected. The command key simply calls that menu item, so it doesn't matter if it says "cut button" or "cut picture". I've installed this script into my HomeCard, so that I can access it from any stack.

```
on functionkey whatkey
  if whatkey is 6 then
    type "x" with commandkey –
    Cut whatever is selected
    domenu "background" – enter
    the background
    type "v" with commandkey –
    Paste it
    domenu "background" – leave
    the background
  end if
end functionkey
```

From AUC

From: UDUS010@uk.ac.kcl.cc.
vaxb

Subject: HyperCard translators



Dan Shafer's book on HyperTalk programming refers to a call; set language to ... in versions of HyperCard later than (and including) 1.1. If you use the command in 1.1 or 1.2 you get a message; no translator for ... I rang ADG about sources of the translators today (PM)... no one there!

I rang Apple UK techies. "What set language command? I'll ask someone else.. never heard of it!" "Sorry... they don't exist yet... how about knocking one up this afternoon!!" All in good fun I hasten to add... I'm not really having a go! BUT... my question remains unanswered! To confuse the issue further, a colleague who attended the initial AUC presentation set language to French on the copy of HyperCard that was distributed at that presentation. It converted all the scripts into French! Now we can't find that original version, but the 1.0.1 official Apple (UK) release does not respond to this command in this way. Can anyone help on a source for the translators that are obviously lurking somewhere... despite Apple (UK) being unaware of them!

David Riddle Editor Wheels (UK)

From: "Roland Mjansson, LDC, tel 7436" <ROLAND_M@seldc52.earn>

Subject: RE: **HyperCard translators**
Translators are stored as WTRN resources. The name of the resource is used in the "set language to ..." command. Some prereleases of HyperCard included a translator for French. It was a simple word by word translator.

A WTRN resource is a code block (with no header). When HC calls it, it passes a pointer to a command block on the stack. The block includes a request code, a handle to the source text, an array of user data (for the translator's static data) and some less common used fields. The translator translates the source text, and returns a handle to the translation and a result code.

The WTRN is called when the "set language to ..." command is used when "Quit HyperCard" is selected from the File menu when the user presses return to execute the contents of the message box

immediately before the script window appears when the user clicks OK in the script window HyperCard stores scripts in plain English to ensure that all version of HC can interpret all scripts. As far as I know, the only versions of HC that includes a WTRN is the Swedish version. Why I know this? Well, I wrote the Swedish WTRN...

This information is believed to be correct. All opinions are mine alone. Apple Computer or Lund University are in no way responsible for this message.

Roland Mansson, Lund University Computing Center, Box 783, S220 07 Lund, Sweden Phone: +46-46107436 (work), +46-46111539 (home) Bitnet: roland_m@seldc52 AppleLink: IT0073

From: Norbert Mueller <K360171@aeam.earn>
Subject: **Windoids**

Hi everybody, I'm looking for some sample code or guidelines on how to program windoids (or windowids). These are the nice window-like things that appear e. g. as tear-off menus in Hypercard, always remain on top, but frontwindow() always returns the underlying window.

I intend to use these to display information on selected items in a graphics application, so that this info does not occupy a fixed place on the screen.

Does anybody have suggestions or comments about that kind of user interface feature?
Thanks for your re-

plies
Norbert

From: Thomas Fruin <FRUIN@hlerul5.earn>
Subject: Re: **Windoids**

As it happens, I had to tackle this problem some time ago. I've written a "Tool Window Manager", a replacement/front end for the Window Manager in the Macintosh ROM that supports tool windows, or windoids.

It consists of a TWindows.h file that you include in your main sources, and a TWindows.c file with replacements for the Window Manager functions NewWindow, GetNewWindow, ShowWindow, HideWindow, FrontWindow, SelectWindow, Drag Window and GetNext Event. By simply changing calls to the Window Manager by these new calls (with 90% the same parameters) you get the complete functionality of tool windows.

It's written in MPW C, but shouldn't be too hard to modify into something else. It's also commented heavily.

I've sent a Stuffed file to you, Norbert, but would like to know where I should send it if others are interested. Kieran?

Thomas Fruin
fruin@hlerul5.BITNET University of Leiden University of Amster-

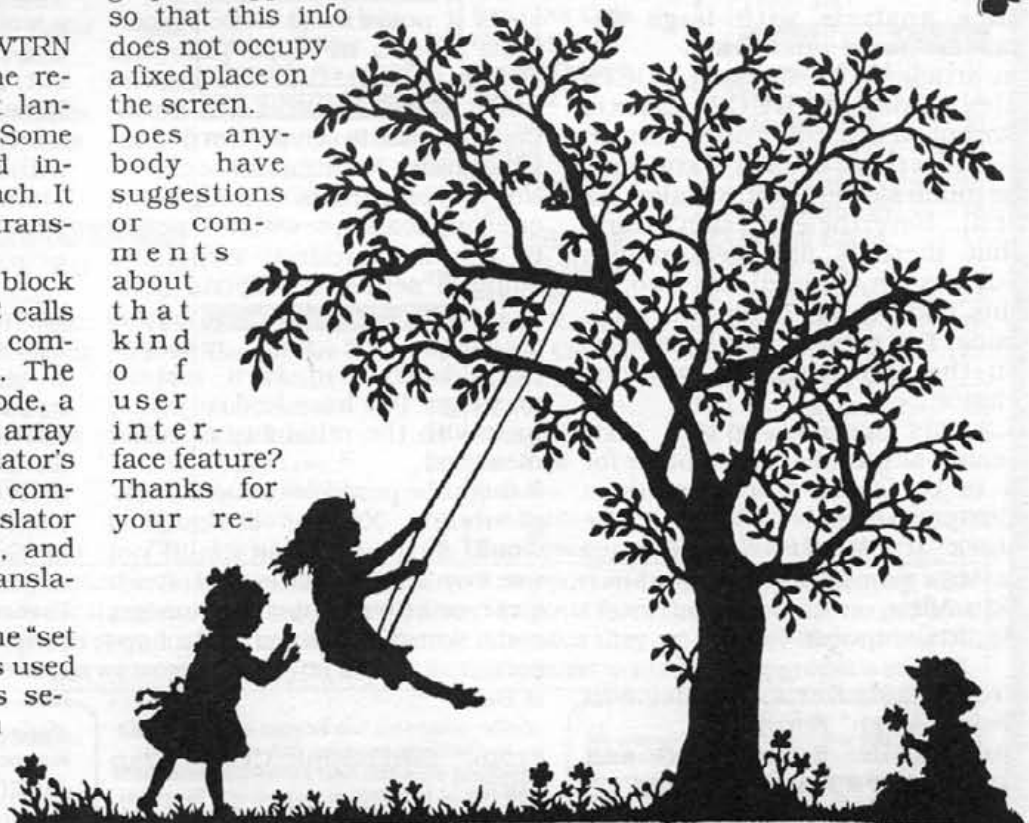

dam The Netherlands

From: Paul Skuce
<comps@uk.ac.hatfield>
Subject: AUC: **Hypercard tip**

If you change the name of the folder that the HOME stack is in (HyperCard Stacks) you will find that HyperCard cannot find the HOME stack. This can be annoying because the folder name is very long. So with a little hacking I found out how it knows where to look. Instructions below.

1: Make a backup 2: Open your favourite disk editor (MacTools, Fedit+ etc) and open HyperCard 3: Search for :HyperCard Stacks: (Note the :s) 4: Replace HyperCard Stacks for your string e.g / Stacks 5: Add the : at the end 6: Count all the number letters etc including both of the colons (!) 7: Change the byte in front of the first colon to this new number in this example with 09 (remember that the number is HEX) 8: Write to disc 9: Quit the editor 10: Change folder name 11: Open HyperCard

This has worked for me but please check the that you have both colons and the byte count is right. Paul

From Usenet

From: dan@Apple.COM (Dan Allen)

Subject: Re: **HyperCard performance analysis with large datasets: Some answers**

In article <5100@dasys1.UUCP> alexis@dasys1.UUCP (Alexis Rosen) writes: >5) I used version 1.0.1 for these tests. It is known to be much slower than >version 1.2 et al. Nevertheless, I don't think that there is any performance >difference between the two, in this text-search situation. >seconds. For serious database work on the Mac, there is only one choice...<

1.2 has speeded up the text-search situation. But in order for it to be faster, you must do a Compact Stack TWICE on the stack. It will then search 6 times faster.

Dan Allen
Apple Computer

From: korn@eris.berkeley.edu (Peter "Arrgh" Korn)

Subject: Re: **System 6.0 and HyperCard's Play command**
In <984@mtund.ATT.COM>.

newton@mtund.ATT.COM (Newton Lee) said: > >System 6.0 seems to break HyperCard's Play command! In other words, >the Mac generates a lot of background noise while playing sounds. >Does anyone notice this problem? Is there a patch to System 6.0?

There was a bug in System 5.0 and asynchronous sound play. It didn't. Hypercard 1.0.1 had asynchronous sound play, but that was because Bill wrote it himself & didn't use the operating system. I suspect that you are not using Hypercard 1.2 (let alone 1.2.1), which hasn't given me any problems with System 6.0 & asynchronous sound play. While I haven't tried 1.0.1 (or 1.1, for that matter) with System 6.0, it is a somewhat reasonable guess that there may be an incompatibility problem with older HyperCards, later systems, and asynchronous sound play (which all playing of sounds in Hypercard is - asynchronous that is). Someone from Apple would be in a better position to verify this for certain, but... Make sure you are using the latest HyperCard.

Peter "Arrgh" Korn

From: wblj+@andrew.cmu.edu (William M. Bumgarner)

Subject: Re: **HyperCard & Multi-Finder**

>> Is it possible to write HyperCard scripts in HyperTalk that would run in the background under MultiFinder? i.e. Is multi-tasking within HyperCard possible under MultiFinder?<<

No. Hypercard is a foreground only application- when switched to the background, Hypercard (should) sends a suspend message to the current card. After this message, the next message (should be) sent is a resume message. (We have had very little luck with the reliability of either message).

It might be possible to run a backgrounding XCMD, although I would suspect that it could not use any SendCardMessage, EvalExpr, or other action that causes some sort of script action to happen.

B.Bum

From: dan@Apple.COM (Dan Allen)

Subject: Re: **HyperCard & Multi-**

Finder

In article <991@mtund.ATT.COM> newton@mtund.ATT.COM (Newton Lee) writes: > >Is there a way I can make several HyperCard stacks running at the same time (background execution) under multi-finder? Newton Lee Advanced Workgroup Systems AT&T Bell Laboratories<< There is good news and bad news on this topic. The bad news is that you cannot currently run two copies of HyperCard under Multi-Finder due to a problem with the sound manager, so only one stack at a time.

The good news is that at least we are aware of this problem and are working on various solutions to the single stack/no backgrounding problems. Look for them in the 2.0 release of HyperCard next year.

Dan Allen HyperCard Engineer

From: klatchko@bnrmtv.UUCP (Ron Klatchko)

Subject: **Hilighting text in hypercard field**

I am attempting to write an application in hypercard, part of which needs to locate and display words (in context) of a field. At first I considered putting the word and its neighbours into the message box but I was not pleased with this method. I therefore decided to write a routine that would highlight a word right inside the field, just like hypercard does. As it turns out, this is easier said than done. Does any out there know of a method to do this (preferably without resorting to an XCMD). Thanks in advance.

Ron Klatchko ...!(decwrl. ucbvax)!h plabs!bnrmtv!klatchko

From: ns@cat.cmu.edu (Nicholas Spies)

Subject: Re: **Hilighting text in hypercard field**

In HyperCard 1.2 (in Authoring or Scripting mode) use select <chunk> of field

Nicholas Spies Center for Design of Educational Computing Carnegie Mellon University

Usenet is a non-profit network whose primary aim is the sharing of technical info and the spreading of research results.

AUC material is from an unmoderated mailing list run from Univ. Coll, Dublin by Kieran Cawick. Anyone with access to JANET can join by sending mail to: mac-user@irlcarn.earn



MacLine

Wren House, Sutton Court Rd, Sutton, Surrey, SM1 4TL, United Kingdom

01-642 4242

UTILITIES & DA'S

Calc Construct	39.
Calendar Mker	33.
Copy II Mac	26.
Disk Express	34.
Disk ToolsPlus	34.
DiskTop 3.0	33.
Epstart	29.
Fnt/DA Juggler	39.
►Fontshare	49.
Gofer	49.
HFS Backup	33.
Hyper DA	44.
Icon It	49.
►On Cue	39.
Power Op	39.
QuickKeys	69.
QuickDex	42.
►Redux	69.
Stppng Out 2	65.
Suitcase	38.
SUM	69.
Smartsrap	39.
Smart Alarms	38.
" " multi user	99.
Tempo II	95.
►Xris-Xros	49.

DATABASES

Dble Helix II	365.
►Foxbase	325.
Omnis 3 Plus	155.
" Multi User	call
Reflex Plus	179.
Record Hldr+	54.

NTWRK/COMMS

In Box	90.
Laplinc Mac	99.
Msoft Mail 4n	149.
QuickMail 10n	249.
Red Ryder 10	65.
Timbuktu	75.
TOPS	130.
WS3000 V22	355.
Vicom	140.

WORD PROC.

Acta	39.
Expressionist 2	89.
FullWrite	255.
Msoft Word	220.
Thunder	35.
Wordfinder	44.
Word Perfect	245.

GRAPHICS

Canvas	135.
Comic Strip Fc	69.
Cricket Draw	195.
Crystal Paint	49.
Desk Paint	85.
►Dgtal Drkrn	175.
►Dreams	375.
Freehand	350.
Illustrator 88	350.
Image Studio	425.
McCalligraphy	115.
MacDraft	165.
Pixel Paint	269.

PROGRAMMING

Lasertalk	169.
Lightspeed C 3	115.
" Pascal	call.
Turbo Pascal	55.
Tutor	46.
Num Methds	59.
Dbase Tlbox	59.
TMON	92.
VIP 2.5	95.

BUSINESS

101 Mcros Exl	call
BulkMailer	99.
Cricket Graph	125.
Cricket Presnts	299.
MacCalc	89.
MacMoney 3	89.
Market Mnger	199.
Msoft Excel	220.
Msoft Works	160.
PowerPoint	235.
Wall St. Invstr	299.

Access Accounting
with custom installation.
call for details

ENTERTAINMENT MONTH!

next generation Macintosh Games

Tetris	24.
(mental agility & dexterity)	
MacGolf II	59.
(colour Mac II version)	
MacCourses	25.
(new courses for MacGolf)	
Shufflepuck	29.
(fast, furious, futuristic fun)	
Colony	32.
(3D interactive fiction)	
Lunar Rescue	call.
(strategy arcade action)	
Fast Lane	52.
(new car racing simulation)	
Ancient Art of War at Sea	29.
(relive famous naval battles)	
Chuck Yeager	39.
(colour Mac II flight simulator)	
Crystal Quest with Critter Editor	59.
(best game now even better)	

HYPERSTACKS

►101 Scripts & Buttons for HyperCard	call
Focal Point	65.
Icon Factory	29.
Reports	65.
Script Expert	49.

MUSIC & ED.

Concertware +	45.
" + MIDI	99.
Jam Session	35.
Kids Time	29.
Puppy Love	21.
Reader Rabbit	39.
Studio Session	69.
Typing Tutor 4	39.

SCANNING

Thunderscan	189.
Vrsn 4 sware	27.
Power Ports	34.
MacScan	1795.
Microtek from	995.
Read-It	229.
Read-It TS	95.

CLIP ART

Visual Arts 1	65.
Comic People	35.
WetPaint Bndl	49.

DTP

PageMaker 3	440.
Picturebase 1.2	59.
Quark Xpress 2	560.
Ready,Set,Go4	425.

MATHS & STATS

Eureka	125.
MathView Pro	145.
StatView 512+	195.

GAMES

Ancient Art War	29.
Bynd Drk Cstle	31.
ChessMaster	29.
Crystal Quest 2	35.
Deja Vu	25.
Falcon	34.
Ferrari G P	34.
Fkcker Triplane	34.
Go	28.
Hitchhiker Gde	18.
Lther Goddess	18.
MacGolf	38.
Pattn v Romml	29.
Pinball Cns Kit	22.
Psion Chess	24.
PT 109	34.
Shanghai	29.
Star Trek	28.
Solitaire	29.
Sub Battle	29.
Tass Times	26.

FONTS

Adobe Fonts	call
Fontastic Plus	44.
Fontographer	225.
Fluent Fonts	36.
Flnt Laser Fnts	59.
Laser FX	149.
Wrld Clss Fnts	49.

HARD DRIVES

MiniQisk 20	call.
MiniQisk 45	499.
MiniQisk 70	650.
Qisk20Mb	call.
Qisk45Mb	580.
Qisk70Mb	720.
Qisk100Mb	920.
Qisk140Mb	1150.

HARDWARE

►Fax Modem	call.
McPlus Mouse	60.
SE & II Mouse	75.
MacRecorder	145.
Quikstick	49.
Toolkit	15.
Turbo SE	350.

BOOKS

Hypercard Hbk	27.
Dsign for DTP	12.
Gde Omnis 3	20.
Excl Ad Us Gd	17.
Using Excel	18.
Excl Mcro Lib	18.
Illstratr Hndbk	17.
Inside Mac V 1	23.
Inside Mac V 2	23.
Inside Mac V 3	19.
Inside Mac V 4	23.
Inside Mac V 5	23.
Mac Adviser	16.
Mac Bible	20.
P. Pub PgeMkr	17.
Quark Cmpn	11.
Wrd MadeEasy	16.
Word Perfect	20.

MacLine sells software from two sources: (a) UK distributors that stock, support and upgrade (by agreement with the US publishers) and include local registration cards and (b) Direct imports from the USA where no genuine local distributor exists. If our prices seem high on certain products it is because they are not grey imports but UK distributed versions. In the long run we would advise you to "buy British", access to support & upgrades is assured.

Policy

- *Credit cards will not be charged until the order is shipped.
- *If a partial order is despatched, the balance is posted free of additional postage charges.
- *All Goods are sent by Insured Registered First Class Mail.
- *Courier services are available.
- *Defective software is replaced immediately.
- *Refunds will only be given on unopened packages that are returned within 7 days of receipt.
- *Prices are correct at time of going to press.

Call for a free copy of our catalogue which contains our full range of hundreds of Macintosh hardware and software products, many of which are not included in this ad. **European orders welcome**

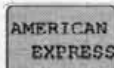

Ordering

- *To order call Monday - Friday, 9.30 to 5.30.
- *Add £2.50 Postage & Packaging (£7.00 on Hard Drives and orders over £300 for Securicor delivery)
- *Add VAT to the total price, except on books.
- *Payment is by credit card, cheque or money order.
- *Government departments, Educational, and PLC companies are welcome to purchase with an order.
- *International orders accepted with credit card only. Postage will be added at cost, call for prices.

Recent Press Releases

The Seoul Olympic Organisation Committee (SLOOC) kept track of more than 20,000 participants in the "24-day Olympic Torch" relay run by using a 4th Dimension (4D) relational database application on Apple Macintosh II computers.

The 4,295.6 km run, which marks the traditional build-up to the start of the Olympic Games, began on August 27th in Cheju, Korea, and passed through six major cities before finishing in Seoul stadium on September 17th.

A vast array of information was monitored by the application, including full colour maps plotting each segment of the relay course, scanned photographs and recorded comments of the runners. A database of participants' vital statistics - clothing and shoe sizes, for example - facilitated planning of the event.

All information was instantly accessible via 4D and the Apple Macintosh. Among the Korean and overseas celebrities taking part in the run were world-famous Chinese gymnast, Li Ning; president of the National Olympic Committee, M. Zahir Naseer; and Korea's Miss Universe entrant, Jae Ho Song.

The Olympic Torch Management System was developed by Bit Computer on 4D as a service to SLOOC. It took the company three months to develop the application and three officials spent two months inputting the data needed to plot the run.

SLOOC made the application available on the Macintosh to journalists and television broadcasters at the Olympic Games headquarters for the duration of the relay. The daily plotting of the run enabled them to receive up-to-minute information regarding the status of the event.

The 20,756 people in the relay included runners, back-up runners and escorts; of this total, 1,282 were main runners, each covering one segment of the relay.

An average of 195.25 km was run each day. The shortest sector of 0.4 km was covered by Joseph Ku, a Catholic priest. The longest segment of 6.3 km was run by a Korean athlete, Jeong Soo Kim.

The oldest participant was 79-year old Jae Soong Kim, an experienced marathon runner. Nine-year old Korean primary school pupil, Eun Mie Kim, was the youngest runner. 🍏

Boston (MacWorld Expo), August 10th 1988 - Mainstay today introduced MarkUp, a multi-user application for workgroup editing and review on Apple's Macintosh computer.

"The edit and review process typically requires the differing opinions of an entire group; therefore, making this business activity notoriously painstaking and time consuming", said Tom Nalevanko, president of Mainstay. "MarkUp dramatically improves the efficiency of this process by permitting group members to edit any type of Macintosh document without having the application that created it. Reviewers can mark up, highlight, expand and annotate reports, drawings, art, scanned photos, spreadsheets and other types of documents. MarkUp supports a physical workgroup on a network like AppleShare as well as a logical workgroup where members are dispersed and send files via disk or telecommunications".

MarkUp is based on a simple metaphor, that of markups on a set of transparent overlays of an original document. A MarkUp printer driver produces an image of the original document which is entered into a multi-user database where access controls are established. Tools are provided for each group member to edit and mark up a separate layer over the document in a traditional manner. They include: a text tool for free standing text, a note tool for pop-up notes, a highlighter, tools for lines, arrows and rectangles and a lasso.

Colour enhances the MarkUp display including text editing styles which can be set up as preferences. All layers can be consulted, subject to access, and the master reviewer can collect comments from all layers. The original document is revised using MultiFinder or the edited document can be printed.

MarkUp is published by Mainstay, and is exclusively distributed in the UK by The MacSerious Company. 🍏

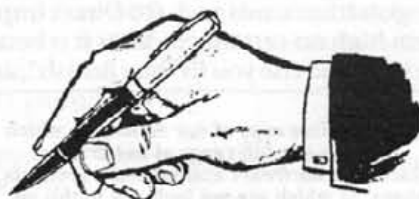

At least 1,500 Apple Macintosh computers will be installed throughout Arthur Young's 22 offices around Britain over the next three years. Arthur Young, the international accounting and management consulting firm, have placed an order with Apple Computer UK worth over £3 million.

Arthur Young's audit practice has standardised on the Apple Macintosh for its professional staff worldwide. In the UK, extensive use is being made of Macintosh computers in that area as part of its ongoing audit automation strategy which includes the use of custom-developed software as well as such commercial packages as Microsoft Excel, PowerPoint and Word.

"Key criteria in choosing this system were quality of service to AY clients, together with the user-friendliness and fast learning curve of the Macintosh itself", said John Howells, Director of Arthur Young's audit practice.

"The combination of our audit and accounting software and a computer that is so easy to use will free professional staff from many of the mechanical tasks of auditing, so that they can spend more time on the complex issues arising in today's audits", Howells added.

Pilot schemes are currently in progress to provide a firm-wide comprehensive office system, based on the Macintosh, which will develop closer links between professional and administrative staff. The projects are being undertaken by the firm's information services department and encompass word processing, access to mainframe systems and electronic mail and document processing. The Macintosh networks are being linked to the firm's IBM mainframe and will integrate with the firm's existing population of IBM PCs.

Commenting on the agreement, Apple UK Director of Marketing, John Leftwich, said "I am particularly pleased about this order, as it came about after a critical competitive evaluation of both Apple and the Macintosh. Arthur Young has a reputation for creative client service and their adoption of Macintosh will allow them to be even more productive and responsive to their clients' requirements." 🍏



The mouse that

ROARED



SHARP STUDIOS
GRAPHIC DESIGNERS

11/12 Irwell Chambers East
Fazakerley Street
Liverpool L3 9DP
Telephone: 051 227 2788
Fax: 051 236 7437

A MEMBER OF THE **SCHAFLINE** SCHAFLINE GROUP

Mac Library

Macintosh Library Catalogue

A new Macintosh Library Catalogue will be issued shortly. **Please Note carefully** that once the new catalogue is sent to members, disks 901 to 908, the Update Disks will be withdrawn because all the material they contain will have been assimilated into the main categories of the library. Check that you have been registered as a member who owns a Macintosh or you will not be sent a catalogue for the Mac Library when it is ready.

New Disks for October

Altogether there are forty-six new disks to be described for the new Catalogue. In this issue I shall describe only the new Graphics disks of which there are sixteen. Some material on the first two disks has already been described when it was issued on an Update disk.

Disk 251 Graphics 21

Contains:- SuperVision + docs, SuperPaint Patch + docs, Graf3D Demo, Giffer 0.96, MandelZot 0.9 + docs, Bill the Cat, Draw it Again Sam + docs, Maps and ARRL

Graf3D Demo This program is based on an article by Scott Berfield in Mac-magazine (Vol 3, March

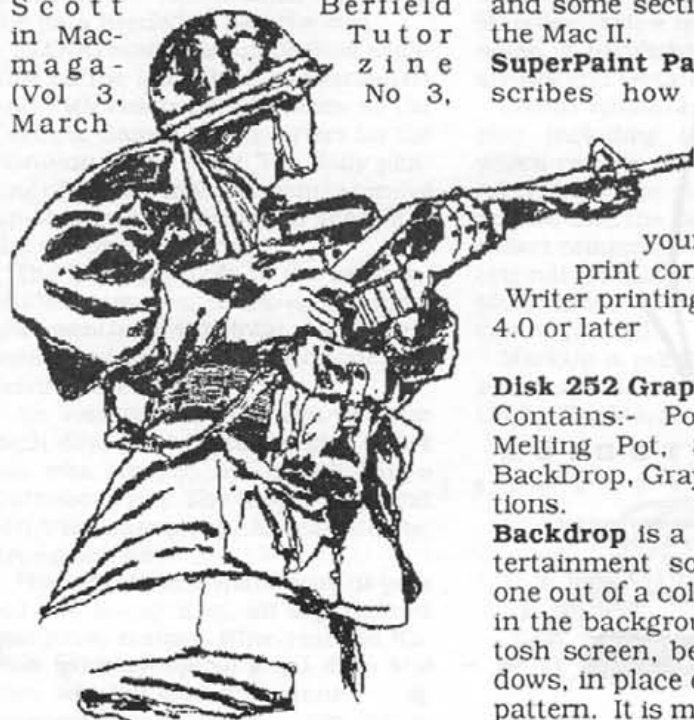

1987), seek out the original article for more detail.

Graf3D is a set of routines for the Macintosh that sit "on top" of the regular QuickDraw calls. Graf3D provides a framework for 3D drawing with calls like "MoveTo3D" and "LineTo3D" etc, as well as various routines to control viewing and perspective.

ARRL is a MacPaint version of the ARRL Diamond logo.

MandelZot 0.9 is a program designed to calculate and display the Mandelbrot set. It will run on any machine from a Mac Plus on up to a Mac II with a 24-bit colour card. System 4.1 or later is required.

Draw it Again Sam is an object-oriented drawing program that provides several unique capabilities. Some of the special features of the program are Libraries, Layers, Drawing Modes, Colour. This version is not a full implementation.

SuperVision is a gray scale image processor. With it you can store gray level information from the MacViston™ digitizer, load files created with Thunder Scan™, or load pictures created in other programs. Some of the program will only work on the Macintosh and some sections only work on the Mac II.

SuperPaint Patch. This file describes how to install the SuperPaint Laser Printing Patch. The patch updates your SuperPaint to print correctly with Laser-Writer printing software version 4.0 or later

Disk 252 Graphics 22

Contains:- PolyAct, SpiroToy, Melting Pot, String Art Plus, BackDrop, GrayView and Animations.

Backdrop is a small piece of entertainment software that puts one out of a collection of pictures in the background of the Macintosh screen, behind all the windows, in place of the normal grey pattern. It is meant for hard disk

users, since the pictures require a lot of disk space. In order to use Backdrop, you must have a Mac Plus, Mac 512 Enhanced, Mac SE, or Mac II. A selection of backdrops are included.

GrayView is especially designed to convert ThunderScan™ SCAN documents to gray scale images on a Mac II. This version allows the user to manipulate the picture in several fundamental ways, sort of like a MacPaint for gray scales. Also, GrayView can be used to view and manipulate any PICT image, colour or B/W.

Animations folder contains the VideoWorks Player and a set of animations which can be viewed using the Player.

Disk 253 Graphics 23

This disk contains a set of VideoWorks animations. They were created with VideoWorks I and the Player is included. You do not need to have VideoWorks 1 in order to run the animations.

Animations:- AirStrike, Wartime, Apollo, New York, Mandel 1, Mandel 2, Bottle, Spiney.

Disk 254 Graphics 24

This disk contains animations created with VideoWorks II and you do need to own VideoWorks II in order to run the animations.

Snap Animations Folder:- Snap Animations, Ant Eater, Growin' Plant, Movin' Tree and Light, Rotating Pyr, Slither Graphics, William Tell.

Clip Animations Folder:- Balance Beam, 12 hour clock, Face-sad-happy, Marquee-big, Scroll Background, Swearing.

Others:- Alien Invaders, Alienses, Crazy Driver, Harry, The Food Chain.

Disk 255 Graphics 25

Contains StuffIt and Documentation, PictureViewer and the following MacPaint files:- Dewdrop, Eight Heads, Escher's Fish!, Escher's Fish.SIT, Eye, Mac Escher, Birds, Fishes M a C E - sher, Metamorphosis, Pegasus, Reptiles I, Reptiles II, Sky and Water Swans, Order and Chaos,

Puddle, Rippled Surface, Spirals,
Three Worlds.

Disk 256 Graphics 26

This is a disk of Military Art, it contains PictureViewer and Show, which are graphics viewing programs. You do not need MacPaint to view the pictures.

Soviet Military Art Paint

Soviet Equipment EQUIP (ADA)
SOVIET EQUIP (ARTY) SOVIET
EQUIP (RIVER CROS) SOVIET
EQUIP (TRACK) SOVIET EQUIP
(WHEELED)

Soviet Symbols SOVIET SYM-
BOLS #1 SOVIET SYMBOLS
#2

US Military Art. Paint

US Helicopters AH-1S BIG.AH-
64 BIG.HIND BIG.UH-1CH-47
HELICOPTERS #1 HELICOP-
TERS #2 HIND.E & LYNX

HIP.E KIWAW

OH-58D.1

OH-58D.2

STATIC.AH-64 US Other
APC'S #2 ARMOUR PERS
CARRIER #1 ARTILLERY #1
MINATURE VEHICLES TANKS

US Soldiers paint SOLDIER
#1 SOLDIER SCENE #1
SOLDIER SCENE #2 SOLDIER
SCENE #3

US Military Symbols BRANCH
SYMBOLS #1 BRANCH SYM-
BOLS #2 BRANCH SYMBOLS
#3 GENERAL MILITARY SYM-
BOLS (GMS) GMS (CLASSES
OF SUPPLY) GMS (EQUIP
SYMBOLS) G M S (C O L L /
COMMO/ELEC)

Disk 257 Graphics 27

This disk contains two graphics viewing applications, "Show" and PictureViewer, (you do not need MacPaint to view the pictures), together with the following MacPaint files:-

WWII Japanese Ships

Battleships Fuso Ise Kongo
Nagato Yamato

Destroyers Akizuki

Fubuki

Hatsuharu

Kagero

Kamikaze

Matsu

Minekaze

Mutsuki Shimikaze
Shiratsuyu
Heavy Cruisers Aoba Mogami
Takao Tone
Light Cruisers Agano
Katori Kitakami Kuma
Nagara Oyodo Tenryu
Yubari

Disk 258 Graphics 28

This disk contains pictures of American football teams in action, together with Picture Viewer so you can view the pictures etc without MacPaint.

NFL Football Pics 1

Atlanta Chicago
Cleveland Dallas (Disk
Label) LA Raiders Miami
NY Giants NY Jets
Pittsburgh Seattle

NFL Football Pics 2

Cincinnati Denver (Disk Label)
Green Bay Kansas City San
Diego San Francisco Tampa
Bay Washington LA Rams

Disk 259 Graphics 29

This disk contains more pictures of American football teams in action, together with Picture Viewer so you can view the pictures etc without MacPaint. There is also another folder of pictures.

NFL Football Pics 3

Buffalo Detroit
(Disk Label.3) Houston
Indianapolis Minnesota
New England New Orleans
Philadelphia St. Louis

Bizarre Pictures

Bizarre Bud Brain Dream
WR-Man with Hat
Creatures Artoo
Detoo Bad
News Coyote



Military Art
from Disk 256



Bird and Lotus from Disk 321

DRACULA 1 Dragon
 Dragon 2 Little Wookie
 Minotaur Robot Skulls
 Val-Dragon Prince Werewolf
 (Vallejo) Dragons&Skulls
 Dragon #5 Dragon of Wantley

Disk 260 Graphics 30

This disk contains a varied selection of clip-art, together with Picture Viewers so you can view the pictures etc without MacPaint.

Animals Animal Clips
 Animals 1
 Cartoon Clips Disney
 Clips #1 101 Figures
Holidays 4th of July Holiday
 Samples July 4th Liberty
 Bell MacTidings™ Sampler 1.2
 Miscellaneous Mother's Day

Sports Sports cartoons
 SportsClips Sports 1 Sports 2
 Sports 3 Sports 4

T N A

About Garfield... More Smurfs
 Smurf-BlowWhistle
 Smurf-Crying Smurf-Driving
 Smurf-InLove Smurf-OhNo!
 Smurf-Raspberry Smurf-Writing
 Nude with Snake
 Sporting Smurfs Smurf-Biker
 Smurf-Bowling Smurf-Football
 Smurf-Golfer Smurf-Soccer
 Smurf-SunBathing
 TNA Sampler WR-Man with Hat
 TNA-Sampler-R1 TNA-Sampler-
 R2 TNA-Sampler-R3 TNA-
 Sampler-R4

Disk 321 Graphics 31

This disk contains a varied selection of clip-art.

Apocrypha Astronomer
 Baroque Bird & Lotus
 Boot Lady Corncocks
 Flower Cat Ichthyocentaurus
 Infinite Pursuit Italian Panel
 Knight in Armour Lacrosse
 Player Lysistrata Moth &
 Moon Paisley 3 Palingenia
 Horaria Persian Flowers 2
 Quadrants Rhinoceros Skeleton
 2 Soka Stela & Altar
 Sundial Hat Swirls
 Temple at Tulum 1
 Wild Tulip Zebra Lady

Disk 322 Graphics 32

A disk of MacPaint files.

Cartoons by Joe Davis

Bear/Raccoon Bulldog
 Camel/Elephant Bully B u n n y
 DiskArt Goat/Donkey
 Hemorrhoidogram Horse/
 Cow Jack in Box Kitty
 Lion Out of Order
 Owl Pigs Retired Sheriff
 Squirrels Stork Tom & Jerry
 Christie B Flower Lady
 Girl with Hat Ingrid Marilyn
 Piano Lady Play.4 Sandra
 Skirt Lady Suntry S W I M -
 SUIT Tiger Lady TS by Mike
 Howell 2Swords Birds.1
 Birds.2 Grizzly House
 Warrior

Disk 323 Graphics 33

This disk contains a varied selection of clip-art, together with Picture Viewers so you can view the pictures etc without MacPaint.

PictureShow "Show"
 About "Show"... PictureViewer
Aircraft apache firing Bell
 UH-1H Helicopter D C - 1 0
 Aircraft F-14 Aircraft Helicopter
 1 Lockheed SR-71 Space
 Shuttle LANDING/COLUMBIA
 M.M.U. NIGHT LANDING/
 CHALLENGER V F - 5 1
 Tomcat Voyager

Boats Fleet's In Nautilus!

Nautilus Nautilus underway
Cars '89 T-Bird Cars
 COUNTACH Dakar gts
 Hudson 1912 & Ford 1913
 Porsche Porsche 911
 Supercar Testarossa

Sailing Ships FIGHTING
 SAIL FRIGATES BATTLE
 SAIL 1 SAIL 2 SAIL 3
 SAIL 4 SAIL 5 SAIL 6
 SAIL 7 SAIL 8 SAIL 9

Trolleys/Trains C&S #9
 DD-963 Trolley#1 Trolley#2
 WP FP7 805A



Disk 324 Graphics 34

This disk contains a varied selection of clip-art, together with Picture Viewer so you can view the pictures etc without MacPaint.

Birds Chick Chickens
Ducks Eagle 2 Eagle In
Flight Goose Hen Humming-
birds Misc. Birds More Misc.
Birds Paradise Rabe Sparrows

Cats 6 Cats CloseUpCat

Himalayan

Leopard with Deer Tiger

Dogs Bulldogs Doggies

Keeshond Spuds

Spuds in chair Wolf

Horses Horse 1 Horse 2

Horse 3

Monkeys Chimp Hamlyn

Monkey Redtail Monkey

Ocean Creatures Beluga/

Blue/Porpoise FishTank

Whale

Other Animals BeeEye

Elephant Misc. Ani-

mals Mouse

Reptiles

Dinos I

Horned Toad

Tyrannosaurus

YAPS (Viewer)

Disk 325**Graphics 35**

This disk contains a varied selection of clip-art, together with Picture Viewer so you can view the pictures etc without MacPaint.

Holiday Cheer Christ-
mas Cards Christmas Labels
Kitty Christmas Michelles' Chr.
Card Christmas Goodies
Christmas Show Adv. Happy
Halloween Mac Folder Mac 'n
Mac Mac ChristmasMac Christ-
mas to all... MaChristmas
MerryMouse Turkey Day
XMAS Cut/Paste

PAINT Blobs

ADVERTISING SAMPLES

Big Bucks Clone Zone

FONTS & FILLS

Friday Breakfast

Hearts & Flowers

HomeSweet Home

LA Olympics Licked

Telephone

PictureViewer

Transportation Folder

Auto Logos Auto Parts Logos

Bergsma Station Bi Plane

BMW Complete Carrera

F-15 Ferrari MacTrucks

Porsches Speedy SR-71

Disk 326 Graphics 36

This disk contains files in Encapsulated PostScript format. You do need to have both an application and a printer which can handle PostScript for them to be of use.

Art Golfer.EPS Michelle.eps

Rose.EPS Spitfire.EPS

The Beatles.EPS

Japanimation

Cap'n Gloval.EPS Rick.EPS

The StatesAlabama.EPS

Alaska.EPSArizona.EPS

Arkansas.EPS

California.EPS

Colorado.EPS Connecticut.EPS

Delaware.EPS Florida.EPS

Georgia.EPS Hawaii.EPS

Idaho.EPS Illinois.EPS

Indiana.EPS Iowa.EPS

Kansas.EPS Kentucky.EPS

Louisiana.EPS Maine.EPS

Maryland.EPS Massachus.EPS

Michigan.EPS Minnesota.EPS

Mississippi.EPS Missouri.EPS

Montana.EPS N. Carolina.EPS

N. Dakota.EPS Nebraska.EPS

Nevada.EPS New Hampshire.EPS

New Jersey.EPS New Mexico.EPS

New York.EPS Ohio.EPS

Oklahoma.EPS

Pennsylvania.EPS

USMap.epsf Using EPS Art

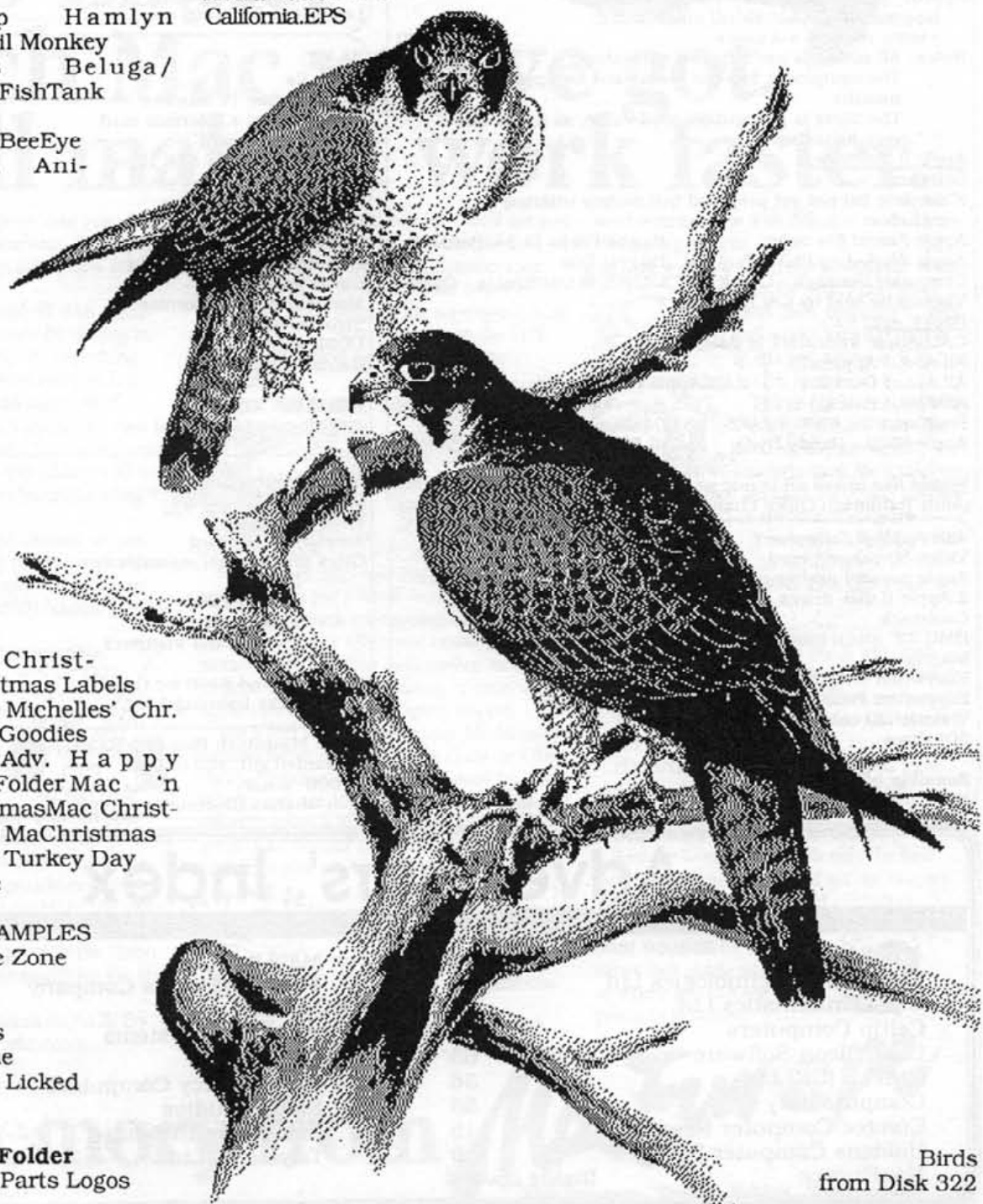

Birds
from Disk 322

Members' Small Advertisements

Members' Small Adverts are FREE. We reserve the right to edit and or omit them. They are placed in this Magazine in good faith. Apple2000 holds no responsibility over items advertised, and buyers purchase at their own risk.

64k Apple II+ with
Videx Enhancer (gives lowercase) £130
7.5 amp power supply £70
2 Apple II 5.25" drives + controller card £70
Rana Elite 80-track drive with 4-drive controller card
and software to patch Pascal £70
Epson MX80 FT + Epson parallel card
+ Dark Star ROM £120
Microsoft CPM 2.2 - card + software £50
Saturn 32k RAM Card £30
Apparat ROM writer card + software £50
Mountain ROM + Card with 4 utility ROMs £50
Hitachi 9" B+W monitor £20
2 Joysticks with trim control £20
Sider 10Mbyte hard disk with upgrade ROM
and full technical manual (loose leaf) £250
Approx. 250 5.25" disks - mainly Verbatim
(approx. 50 double-sided) single sided
- some unused + 3 cases £80

Notes: All manuals are supplied with above
The equipment has not been used for approx. 18
months
The Sider is particularly good value, as it has had
very light use.

Apple II Sundries:

Software:

(Complete list not yet prepared but mainly utilities)

- includes:

Apple Pascal (II+ only); Bag of Tricks (3.3 + ProDos)
Apple Workshop (3.3 + ProDos); Diversi-Dos
Computer Bismark - Game; Cartels & Cutthroats - Game
Various as sold by CALLApple

Books etc.:

CALLApple from start to date
All About Applesoft)
All About DOS 3.3) CALLApple Publications
All About Pascal)
Programming 6502 - ZAKS; 6512 Assembly Language
Apple 6502 - Randy Hyde; Pascal for the Apple - Mac Callum

Would like to sell all to one person at an all-in price of **£500**
John Tomlinson Office Phone no:.....

48K Apple II Europlus
Video 80-column card
Apple parallel printer card
2 Apple II disc drives
Coolstack
BMC 12" green monitor
Manuals
Easywriter Original
Easywriter Professional (80 col.) word processor
Visicale (80 col.) spreadsheet
50+ discs

Sensible offers to:

KH Lane.....

Cannibalized Mac:
128K motherboard
2 x 400k internal drives
Short keyboard (French!)
Lisa mouse
Ideal for repairs/spares etc.
Mac Software:
Lotus Jazz, brand new & sealed
pfs file
pfs report
Apple II stuff:
Bufferpack for Serial Grappler, brand new
Frogger
Softerm II comms, brand new, inc. keyboard expansion

Offers for all/any of the above to:

Lee Harris (Reading) on.....

Item 1:

Apple IIe
Monochrome TV monitor
2 Disc drives + Interface card
Serial printer card
80 column card + 64K Ram

Item 2:

64K Apple II Europlus
Serial printer card
Colour card
Disc drive + Interface card
Game paddles
Monochrome TV monitor
Structured Basic
UCSD Pascal
Games software

Offers to:

Bob Hornby (after 7pm) on.....

Apple II Europlus

Monitor ///
Twin disc drives
Accelerator II board
Discs and original manuals for:
DOS
Apple Pascal
TASC compiler
Visicale and Visitrend

Offers around £100 for the lot

John Marks (evenings).....

Apple Macintosh Plus (1m RAM)

Unwanted gift, still in box

£1000 o.n.o.

Tom Shanks (Durham) evenings.....

Advertisers' Index

A R T Ltd	67	MacLine	73
Bidmuthin Technologies Ltd	25/39	The MacSerious Company	Back cover
C & C Informatics Ltd	55	MacSoft	69
Celtip Computers	45	MGA MicroSystems	15/29/35
Chameleon Software	63	Open Apple	34
Cirtech (UK) Ltd	36	Roger D'Arcy Computers	35
Computability	55	Sharp Studios	75
Comtec Computer Repairs	15	StackWare Unlimited	59
Holdens Computer Services	9	T-systems Ltd	20
MacEurope	Inside covers		



No matter which Mac you've got, we'll make it work faster.

You want more speed from your Mac. Less time waiting, more time working. Now your dream is reality whether you've a new MacII or a 128K of legend.

How about my SE?



Run your SE with MacII performance by slotting in the Turbo SE. Everything runs at least twice as fast; faster than many 68020 designs. A big screen attaches, and the 68881 maths co-processor option runs spreadsheets 60 to 100 times faster (and other programs using SANE).

And because we use the ultimate in compatibility (the same 68000 processor your Mac uses, only twice as fast) your Mac software won't crash. Unlike the 68020 boards. So your data is in safe hands.

And at £449.00 that's irresistible.

With TurboMax you get more speed plus more memory..... 2 to 3 times faster, 2MB of memory, upgradeable to 4MB.

RAMdisk contents are protected, so you can safely work on your programs and data at memory speeds. There's a superspeed SCSI and the 68881 maths co-processor option makes spreadsheets (and other SANE programmes) run 60 to 100 times faster. There's a big screen attachment, too.

Of course, it's as crash proof as the Turbo SE. Fits in minutes without modifying the Mac and it costs only **£1,195**.

TurboMax also re-enhances the 512K Enhanced for an amazing performance.



I love my 512K...



case- the SCSI port exits from the battery compartment.

Bigger software- bigger memory.



To run Apple's great new software you are going to need bigger memory. For scanning, and many other programs, too, 1MB is not enough.

But you just can't risk fitting second-rate memory. You put a lot of work at stake when intermittents crash your system (as they will).

So MacMemory offers you **crash-proof** memory with MaxPlus 2x4S surface mounted megabit chip modules meeting or exceeding Apple's own standards in every respect.

You'll feel safer knowing your MacMemory enhancements use first quality chips (not the cheaper production-reject units used by some others), and are 100% tested at each stage and are even given a final 72 hour burn-in in an actual Mac. No-one else takes this much trouble to give you error-free performance!

A 4MB SE..



MaxPlus 2x4S take your SE to 2.5MB (and onto 4MB), support all Apple standard add-ons and also plugs into Turbo SE. No modifications are required of any kind.

Mac Plus upgrades economically to 2MB and onto 4MB without any mods. Your every

(128K owners... we'll get you to 512K, and then add TurboMax). Connect your SCSI hard disks directly through the superspeed SCSI port. No mods to the 512K

need is catered for with different modules, including big screens.

A 4MB 512K?



You'll love what the Max2 does for your 512K; Max2 gives 2MB, upgrades to 4MB, and works with old or new ROMs and allows a SCSI port to be fitted when you're ready.

Er...



You're not alone - we started off with 128K's too! So don't send yours to the knackers yard. We'll take you to 512K- and then Max2 or TurboMax promise you a new world of speed and software.

And my Mac II?



You need more than 1MB to do anything useful and MaxPlus 2x4S takes you to 8MB!

Remember, even your beautiful MacII will crash, no matter how fast, through intermittents if you fit not-quite-industry-standard memory.

Treat your wonder machine to MacMemory. **It's crash proof!**

Hardware is hardware. But support for it can range from "total" to "non-existent".

MacEurope's is total. All the facilities you expect from a major manufacturer.

And we work closely with only the best dealers. You can expect and get the best service in the industry. (Ask our customers...)

Call Colette Fanning on **(0603) 630636** for more info, super data sheets and details of where you can see our products in action.



MacMemory from

MacEurope

The Granary, Trowse Bridge, Bracondale, Norwich NR1 2EG, England. Tel: (0603) 630636

Fax: 0603 630374

Think 'n Time

New

Think 'n Time is the Macintosh visual organization tool that significantly improves productivity. It's great for developing and organizing ideas, projects, tasks, meetings, schedules, estimates and reports.

Organize Activities & Projects

Visually organize information using an extended desktop. Think 'n Time, T'nT for short, builds an organized tree of sheets and piles of electronic paper.

You create, open, close, collapse, expand and rearrange sheets and piles, all with point and click ease.

Drag sheets or piles to a new position in the tree to reorganize a subject. T'nT links text information to dates and times and numeric values in a completely integrated manner. It's handy for everything from project management to remembering important appointments and birthdays.

Organize Your Future!

Integrated date and time management functions provide an easy way to plan your personal and business activities. T'nT allows you to more effectively plan, schedule, organize, arrange, delegate, direct, control, monitor and analyze your work.

No matter how complicated your life, a "What's Next?" view provides a time-line organization, keeping you on track. A powerful search and browse capability gives you instant recall. Here's real help to handle multiple tasks and projects.

A desk accessory, T'nT is always available for taking down information and accessing ideas, dates, notes and data, eliminating slips of paper.

Think 'n Time £84.95



MacFlow 2.0

New Version

Fast, Clear Charts.

Simply drag chart objects into place and connect them with flow lines. Draw flowcharts up to ten times faster than with drawing programs or pen and pencil. Enter text into symbols, lines and labels with ease.

Changes are just as easy. Resize symbols and move them around as you like; lines stretch and stay attached. Changes are a snap with automatic grid alignment. Resize symbols and add or delete elements with cut, copy and paste ease. Graphically organize even complex programs, projects and structures fast!

Symbols, Your Way.

Use ANSI standard flowcharting symbols or custom design your own symbols with MacDraw™ or any "draw" type program. A hierarchical organization links a symbol on a top level chart to an entire lower level chart.

MacFlow 2.0 £175.00

MacSCHEDULE

New

Visually plan how a project will get done. MacSchedule lets you create clear, graphic schedules fast! Schedules that took hours, now take only minutes. Revisions that almost meant starting from scratch now only take a few seconds.

MacSchedule allows the creation and modification of a schedule directly without elaborate flow diagrams or detailed tables of dependencies.

Status tracking is a snap. Work progression, early and late starts and schedule slips are easily handled. Schedules can be yearly, quarterly, monthly, half-monthly, weekly, daily or free-form. Print out clear, attractive presentations on an ImageWriter or LaserWriter.

MacSchedule addresses the real needs of people making real schedules. It's not complicated PERT chart software that almost requires a degree in project management.

MacSchedule is for the practical, top-down thinker who wants to clearly see the entire picture and then make sure that the job gets done.

MacSCHEDULE £175.00

V.I.P 2.5

New Version

Programming of the future, here today! Visualize your logic and program at a speed you never thought possible! Use V.I.P's graphic editor to develop an icon-based, on-screen flow chart which runs.

You program in a top-down, structured manner using objects, automatic logic forms, nested levels of routines and over 180 pre-compiled procedures

Power for professionals.

Develop and market your software using the run-time package with no extra license fees. V.I.P's also great for prototyping complex routines and models, even for other computers.

Follow-on products make V.I.P the language of choice. These include a series of translators — program visually and then turn a V.I.P program into source code for your favorite C or Pascal. Also available are procedure sets for speech, grid, ISAM, database, matrix, etc...

HyperCard External Procedures!

Starting with the new 2.5 version, V.I.P will let you write external procedures and functions for HyperCard™ (XCMD's & XFCN's) and V.I.P itself. This will require the new Translators to C.

V.I.P 2.5 £99.95

Grid Manager £54.95

Telecom Manager £99.95

Advanced Manager I £89.95

DataBase Manager £245.00

Matrix Manager £89.95

Translators (Lightspeed C & Pascal, MPW C & Pascal, Turbo Pascal) £89.95

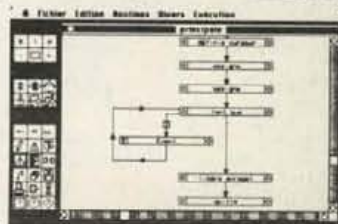

(All prices exclude VAT)

For more information visit the AppleCentre today!

Distributed in Britain and Ireland by

In Europe

MacSerious

The MacSerious Company

17 Park Circus Place, Glasgow G3 6AH Phone 041-332-5622 Fax 041-332-3209

Artwork prepared on Apple Macintosh and output on Linotron 300 at Bureau Graphics, 72 Waterloo Street, Glasgow

Mainstay Europe

Rue des Atrebatas, 71

B-1040 Brussels

Belgium

Tel (322) 733.97.91

Fax (322) 734.89.12

Telex 62 239 Micro b