

# Apple2000

THE NATIONAL APPLE USERS GROUP



JUNE 1989

VOLUME 4(3)

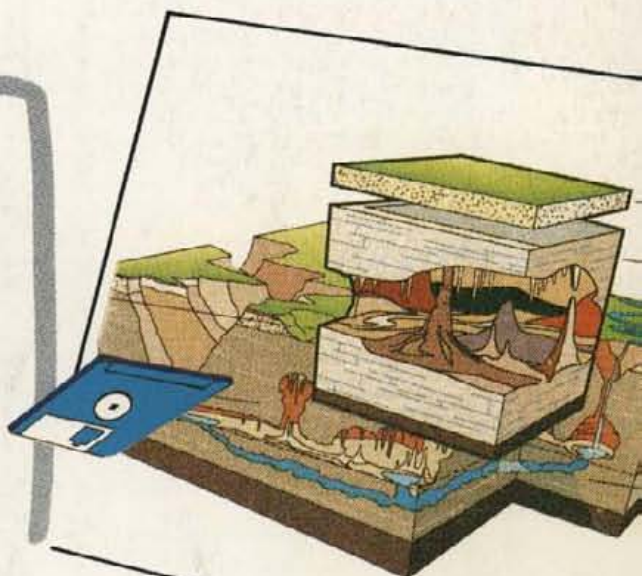
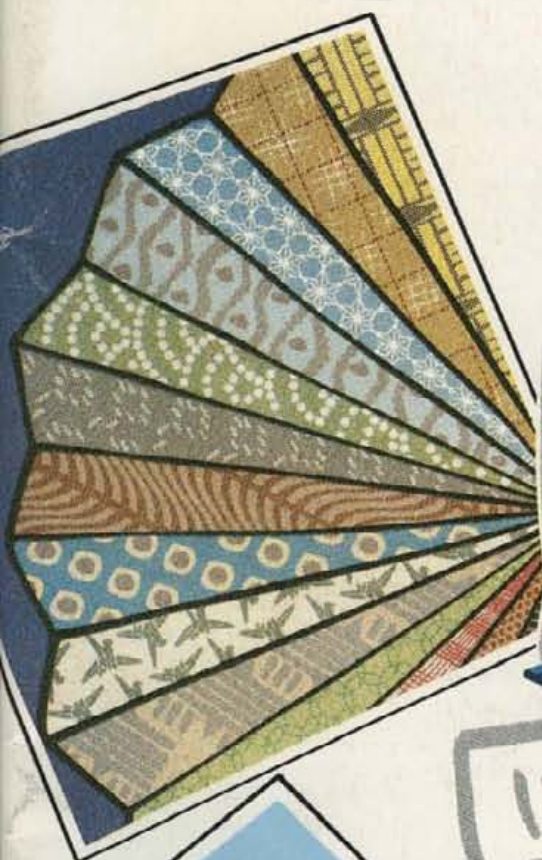

Apple2000  
is the UK's National  
Apple User Group  
with years of expertise  
and that's a fact!

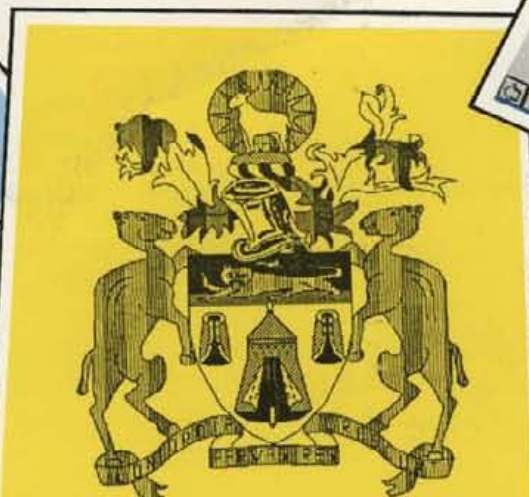

The Worshipful Company of Merchant Taylors  
of the City of London



**APPLE 2000  
RECOMMEND  
SONY  
DISKETTES**



### SCSI INTERFACE CARD

The Cirtech SCSI Interface is a standard slot card for the Apple IIGS, //e or 64K II, which lets you use an SCSI hard disk with ProDOS, DOS 3.3, Pascal and CP/M based programs.

- *Extends ProDOS 8 to let you use up to two hard disks of 128 Megabytes each!*
- *Partitioning of your hard disks for up to four different operating systems is easy with the unique software support*
- **NETWORKING** – *The SCSI Interface can also be used in conjunction with the Cirtech Multi-User Network System software which allows several computers to simultaneously share and partition SCSI hard disks.*

The leading SCSI Interface at only £54.00

### PLUSDISK SC

PlusDisk SC is a brand new concept in storage media. Use it just like a normal disk drive **BUT** a drive with the outright speed of a RAMdisk combined with the safe storage of a hard disk – in fact, the very best of both worlds!

With no mechanical or moving parts, PlusDisk SC gives electronic performance, in total silence!

PlusDisk SC uses special low-power memory which is easily user expandable. It comes complete with its own power source and cable to connect directly onto the back of your Mac Plus, SE or II; or, via a Cirtech SCSI Interface Card, to your Apple IIGS, //e or II.

*The new generation in storage technology from only £348.00*

### PlusRAM-16

plusRAM-16 is a standard slot RAMcard for your Apple II, //e or IIGS which instantly gives you one extra Megabyte of memory and can easily be user expanded to FOUR and, ultimately, SIXTEEN Megabytes!

- *Supported by more software than any other RAMcard – ProDOS, CP/M, Pascal and DOS 3.3*
- *Programs operate at electronic speeds!*
- *Desktop expansion and a whole range of enhancements for AppleWorks*
- *Supplied with unique RamDesk Manager software to divide the huge memory into separate disks and change instantly between them.*

The best value standard slot RAMcard  
ONE MEGABYTE for only £229.00

### CHAMPION PLUS INTERFACE CARDS

Champion Plus cards are the most versatile Interface cards available for the Apple II, //e or IIGS, combining serial (RS232) and parallel (Centronics) Interfaces, together with 100% Apple Super Serial Card & Parallel Printer Card compatibility.

- **Champion Plus Dual (SSC/Champion)**  
Serial and/or parallel output, providing all the features of Super Serial Card mode and Champion Card mode. £78.00
- **Champion Plus Dual (SSC/PPC)**  
Serial and/or parallel output, providing all the features of Super Serial Card mode & Parallel Printer Interface mode. £78.00
- **Champion Plus Serial (SSC/Champion)**  
Serial only output, providing Super Serial Card features and Champion card features in serial output. 100% slot-in replacement for Apple Super Serial Card £68.00

### PlusDISK

PlusDisk is the only plug-in card for your Apple II, //e or IIGS which operates with the lightning speed of a RAMcard AND keeps its contents safe for months, even when there's no power to your Apple!

Using special, low-power memory, PlusDISK safely stores any standard Apple operating system or program (ProDOS, Pascal, CP/M or DOS3.3) ready for *instant start-up* whenever you switch on your Apple. The partitioning software supplied also lets you divide your PlusDISK to create separate areas for different operating systems.

PlusDisk is easily expandable right up to One Megabyte. The back-up power source is contained on the card – there are no bulky external power supplies or batteries!

Ultimate speed from only £128.00

### PlusRAM-GS8 . . .

the special RAMcard for the Apple IIGS memory expansion slot and the only single card to expand from ONE up to EIGHT Megabytes. Use the superfast extra memory as a RAMdisk or directly (or both)! plusRAM-GS8 is fully compatible with all IIGS software like AppleWorks, and ProDOS, DOS3.3, CP/M and Pascal 1.3 programs.

Add a PROMDisk or ROMDisk Adaptor to your plusRAM-GS8 to give up to 256K battery backed-up static RAM or 512K ROM. This lets you boot your favourite program *instantly* from the Adaptor as soon as your GS is switched on!

plusRAM-GS8 – 1 Megabyte for only £249.00

These are just a selection of the Cirtech range of products. For full information on these and our other products, please contact your nearest dealer or Cirtech directly.

ALL PRICES EXCLUDE VAT



CIRTECH (UK) LTD, Currie Road Industrial Estate, GALASHIELS  
Selkirkshire, TD1 2BP, Scotland Telephone: (0896) 57790  
Telex: 9312130256 (CI G) Mailboxes: 84:CPDOO1 (Telecom Gold)  
AAH555 (Source)





## CONTENTS

**\*\*\* STOP PRESS - Apple/Mac 89 - See Page 33 \*\*\***

Chairman's Corner	Ewen Wannop	2
Letter Box		3
C - the language	Dave Miller	8
Controlling the Real World	Bill Hill	12
Hardcore Pips	John Sharp	16
DB Master - a review	T.O. Cymballist	18
The Graphic Exchange - a review	Peter Stark	20
Print Magic - a review	Peter Stark	21
A tale of Eve and that Watchmaker	Mike Tickle	22
Deepspace - a review	Rober t Hornby	22
Rocket Chip - a review	Dave Ward	24
Marble Madness - a review	Richard Bradley	27
TransWarp GS - a review	Ewen Wannop	28
Cool It! - a review	Dave Ward	30
Amnesia - a review	Dave Ward	32
Hot Line News	Dave Ward	32
Apple/Mac 89		33
Applied Apple Spreadsheets	P F McMullin	34
SoftCat Corner	Jon Gurr	37
The Nibbler		38
MacChat	Norah Arnold	42
AnonWare	MacLibrary	43
Nisus - a review	Geoff Wood	44
PostScript Fonts from the UK	Irene Flaxman	49
Apple and the Desktop Publishing Market	Irene Flaxman	49
Koala Source Book of Macintosh Software		49
The Care and Feeding of your Laser Printer	Walter Vose Jeffries	50
N-Font	MacLibrary	54
Learn Persuasion	Irene Flaxman	55
Heraldry III	John Arnold	57
Network News		60
CheapColor	MacLibrary	64
T N # 227 Toolbox Karma		66
T N # 230 Macintosh SE/30		67
Club Business - AGM Minutes		70
Programmer's Online Companion - Mac	John Arnold	73
MacLibrary		76
Local groups		78
Members' Small Ads.		80
Advertisers' Index		80

### There are a number of ways to contact Apple2000.

Force users who have a query about the service can contact the administrator, John Lee, directly for help and advice. Call him on the number opposite or send a message to his box on the Force.

If you wish to order goods or services from Apple2000, call Irene on 051 938 4143 or (during office hours) call Alison on 0732-740415. Both have Ansafones, in case they're not around. Alternatively you can Fax. to 051-949-0307, write to the PO Box or (if you use comms) you can leave orders on TABBS addressed to the SYSOP.

If you are experiencing problems with Apple hardware or software Dave Ward and Tony Dart run the Hotlines and will try and help you.

We are very interested in the activities of local user groups, and if you have any information which you would like publicised John Lee would like to hear from you.

Moans and Groans - We don't get many of these, but the Editors have broad shoulders, so send these to them via the PO Box.

A little praise for a few of our authors wouldn't go amiss. Send all comments, and contributions, via the PO box, especially suggestions about what you would like to see in your magazine.

Apple2000 supports users of all the Apple computers. The ITT 2020, I, II, II+, //e, //c, //c+, Iigs, ///, Lisa, XL, Mac 128, 512 MacPlus, SE, SE/30, Mac II, IICx and IIX

Contributions and articles for the magazine are always welcome. We can handle any disk size or format. Please send to the PO Box, L21 8PY.

#### NOTE:

In general the front half of the magazine is for the Apple II, Apple Iigs and Apple /// The back half for the Macintosh and Lisa. Look out for the descriptive page icons.

#### Key:

Apple II, //e and //c

Apple ///

Apple Iigs

Macintosh, Lisa

Macintosh II



## Contact Points

The Force and Local Groups  
John Lee

Voice 051 938 4143

Administration  
Irene Flaxman

051 938 4143

Fax 051 949 0307

Adverts / Admin.

Alison Davies

0732 740415

Apple II Hotline

Dave Ward

051 938 4143

Mon-Fri 1900-2100

Macintosh Hotline

Tony Dart

051 938 4143

Mon-Fri 0900-17.00 1900-2100

TABBS

Ewen Wannop - SYSOP

Modem 051 949 0307

# Chairman's Corner

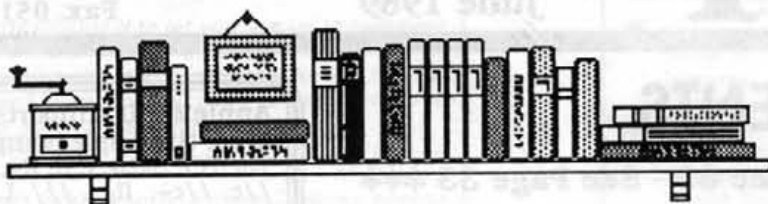

May I start by making some comments on behalf of the production team at Apple2000, and especially the hard worked editors. We produce the magazine in our spare time. We need help from you the members to make all this possible. Please help by contributing articles and reviews on any relevant subject.

We receive many letters for the magazine, very few of these are submitted on disk however. We try to answer them all in due course and often we would like to answer the problems before the next magazine arrives. The sheer volume of these letters, and the need for considered replies, means there may well be some time before you see your reply. We apolo-

gise to those who have waited some time. We are not able with the present level of expert help on the editorial team to improve on this time delay.

Please send letters if at all possible on disk, this saves many hours of typing. Our team of typists are not able practically to help with typing these letters and their replies.

Another apology is need as well. Many of you have contributed material for the magazine. There is simply not enough room to publish it all. It may be some time till you see your article published.

Please support the advertisers in the magazine, and let them know that you saw their advertisement. We balance on a thin

edge of making the magazine as we want, and getting sufficient advertising to make it work. Advertisers will not come back to us if they get no response. The magazine will only suffer in the end if this happens.

We shall be continuing our policy over the next year of trying to improve the standard and content of the magazine. I have mentioned this already in Apple Slices, but it does not come amiss to repeat this now. We hold a unique position in the market place, we must build on that strength. You can help us do that. Submit articles for the magazine, and tell us what you would like to see.

I hope that we shall see a commitment from Apple UK over the coming months to support the end user. We all too often feel that all they are doing is 'shift boxes'. It would be nice to see them plough back some of those profits and help the User who has bought their machines, and who might even buy another one in time!

Finally welcome to you all as your new Chairman. I hope we can make 1989 a great year for the Apple Computer user.

**Ewen Wannop**

**Apple2000** brings you two exclusive systems that will give you all you ever should need in modern communications and messaging. National and International messages, Telex, Software Downloading, Contacts, Problem Solving, Special Interest Groups, Teleshopping, Databases, Telecom Gold and a host of features tailored for **Apple2000** members

Ring **TABBS** on (0225) 743797 at any speed through V21 to V22bis 8N1.

**TABBS** is available 24 hours a day

Ring John Lee on (0373) 84861 for details of **The FORCE**.

Annual subscription rates are £25.00 for UK residents, £30.00 for E.E.C. residents and £35.00 for other overseas members.

Apple2000™ is a trading name of BASUG Ltd, a non-profit making independent company limited by guarantee.

The contents of this journal are copyright of BASUG Ltd and/or the respective authors. Permission is granted for non-commercial reproduction providing the author and source are properly credited and a copy of the relevant journal is sent. The opinions and views expressed are those of the various contributors, and are not necessarily supported by BASUG Ltd.

This journal is published bi-monthly by BASUG Ltd as a benefit of membership in February, April, June, August, October and December. The copy date is the 5th day of the month preceding publication. Advertising rates are available on request.

Apple™ and the Apple logo are trademarks of Apple Computer Inc. Macintosh™ is a trademark of Macintosh Laboratory Inc and used with the express permission of the owner. Telecom Gold™ is a trademark of British Telecom plc. The FORCE™ and Apple2000™ are trademarks of BASUG Ltd.

## The Editorial team is:

### Apple II

Ewen Wannop

### Macintosh

Norah Arnold

Irene Flaxman

Many thanks to all those who work behind the scenes and who receive no personal credit. These people are the stalwarts of Apple2000.

Additional thanks to Walter Lewis of Old Roan Press (051-227-4818) for our printing service, and to Ian Sharp of Sharp Studios (051-227-2788) for our cover design. (Graphics for the cover design supplied by Apple Computer UK Ltd, Adobe Systems Inc., Cricket Software.)

Apple2000 are Founder Members and Whole-hearted Supporters of the  
**Apple User Group Council**



# Letter Box

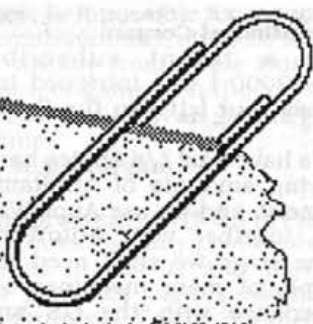

## GENERAL LETTERBOX

Norbury  
London

Dear Editor,

I would like to say how much I agree with the sentiments expressed by John Stanier, in the February issue of Apple2000, regarding Apple's attitude to the British user. Recent reports of their heavy-handed attempts to stop dealers purchasing directly from the US also serve to re-inforce the image of Apple as not caring for the UK market.

Any retailer should be able to obtain his stocks from any legal source in any country of the world and sell them anywhere else, provided they meet the necessary safety standards for the country in which they are sold. Neither manufacturers nor wholesalers should be allowed to refuse to supply, nor to refuse to trade terms and discounts, just because the dealer is 'foreign' or doesn't hold some sort of 'approval' from the manufacturer. Similarly a seller should be allowed to set his own prices and should not be penalised if he chooses to trim his margins and lower prices.

It is, of course, quite legitimate for manufacturers to 'approve' suppliers for the purposes of carrying out warranty repairs or to raise their profile with the public, but such suppliers should not be given more favourable purchasing terms solely on account of such 'approval'; nor should the 'approval' be conditional upon supplies only from designated sources.

Purchasers should be entitled to the full support of the manufacturer's warranty in any country of the world without regard to the source of the goods. Naturally, goods sourced from foreign countries might not be fully compatible with local custom and practice, but that is a separate problem between purchaser and retailer. As everyone knows, even products from 'approved' suppliers far too often ignore UK requirements for £ signs instead of \$ and for dates in the dd/mm/yy format.

The attitude of Apple Computer and others towards 'unapproved' retailers is an unwarranted interference in

and restraint of trade and it is about time that our Government and the European Commission took a firm stance to outlaw this sort of discriminatory behaviour.

## CONSUMER PROTECTION ACT 1987

I am sure that many readers will be pleased to know that the Consumer Protection Act, which recently came into force, makes it a criminal offence to give consumers a misleading price indication about goods, etc other than for business use.

A consequence of the Act, and a code of practice made under it, is that advertising to consumers must now quote VAT inclusive prices and must not hide non-optional extras, like P&P, away in illegible type somewhere, nor so word things that the consumer cannot easily and simply work out exactly what total sum of money he will have to pay to acquire the goods he wants.

Since Apple2000 is clearly a 'consumer' magazine. I hope that Apple2000 will refuse any advertisement which doesn't comply with the DTI's "Code of Practice for Traders on Price Indications" and also ensure that any prices quoted in editorial matter (eg in Reviews and news of New Products) include VAT.

**Vernon Quaintance**

□ The problem of restricted practice from Apple Computer is an old one. AppleCentres seem to be able to quote prices that often are less than normal dealers pay to purchase from Apple direct. There are even rumours that Apple UK will cease to supply anyone other than AppleCentres in the near future.

We will endeavour to see that we keep to the Consumer Protection guidelines. We shall ask all advertisers to conform as well. However most of their business is supplying business customers who are unaccustomed to thinking of VAT in the prices they pay. **Editor**

## MACINTOSH LETTERBOX

Harpenden  
Herts

Dear Editor,

In connection with my letter to you, I saw an article which appeared today in The Independent. Its author refers at one point to writing from right to left and claims that it presents no major problem. He must be right of course.

I have now found that on your Public Domain disk No 015 the Hebrew fonts have a DA device which reverses the order of printing but it does not work with other fonts. I hope that either you or one of your readers will be able to advise me how to change the direction of printing for Arabic fonts.

**Bogumil W Andrzejewski**

## APPLE II LETTERBOX

Heinrichstraße 10  
D-6100 Wiesbaden  
West Germany

Dear Irene,

Thank you very much for your friendly reply to my letter, and the sample magazine you sent me. I would like to become a member of Apple 2000 and am enclosing my completed application form.

Some comments about the letter from Margaret Audin in Paris (October 1988):

I bought Multiscribe just before I heard that the Claris Corporation had taken over StyleWare Inc. I sent off my registration card and at the same time ordered a backup disc. This arrived safely some time later. In January, I read an article in Nibble magazine about AppleWorks GS, which stated an upgrade to AppleWorks from Multiscribe was possible for the GS, so I wrote to Claris to ask if this upgrade was also possible for the //e. So far I have had no reply whatsoever, although as I only sent the letter two months ago this may just mean that they are taking their time, and not necessarily that they don't care about Apple //e users either.

I had some old AppleWriter files which I converted to ProDOS using Copy II Plus. It was then possible to open the files from within Multiscribe and convert them to Multiscribe files. I didn't lose any data, but a certain amount of reworking was necessary. However, if Multiscribe files can be recognized by AppleWorks (I assume this because of the above-mentioned upgrade possibility), then maybe this would be worthwhile for Margaret

Please submit all letters and articles to the magazine on disk wherever possible. The disks will be returned to you when the magazine is published. If you have a modem, send us letters, articles and Public Domain programs either to BSG005 or to TABBS (01223-743727).



#### Audin's work.

I also have The Print Shop, which I thought was very good, and I used it a lot until the end of last summer when I bought a copy of Print Magic, from Epyx, which is even better! However, neither of them can cope with foreign languages, and I don't know how to make them either. If I want to write to my German friends I have two choices: I can write the special German characters out in full, i.e. instead of ä, ö, ü oHr ß, I write ae, oe, ue or ss. Although this is acceptable in Germany, it makes the text difficult to read and it looks messy. Or I can use a modified font for Multiscribe that I have made myself based on Wordsworth font number 3. If I am sending a birthday card or a short note I usually write it in English as most of my German friends can understand English anyway, but this is hardly a solution to the problem!

I like Multiscribe a lot, but I find it rather slow sometimes and I have to be careful that I don't get words with letters missing because I have typed too fast. Two things I miss about Multiscribe are a hyphenation function and a hard space (to hold things together that shouldn't really be separated, e.g. 120 kg or Mr Smith). If anyone has any advice or hints about using Multiscribe I'd be very pleased to hear them.

I am looking forward to the arrival of the next Apple 2000 magazine.  
**June Baker**

Sevenoaks  
Kent

Dear Editor,

Do you know if there is a driver to do graphics dumps to my Centronics 739 from the //e.

**Mike Tickle**

□ There are various problems related to making graphic dumps on the Apple II. First of all the printer must be capable of being addressed with 8-bit data that will be sent straight to the print head, this rules out all but dot matrix printers. Secondly, the printer card must be able to pass 8-bit data when requested. Thirdly you need a routine that can dump the screen data in the format the printer wants.

No two printers are the same in my experience, and most programs expect the ImageWriter to be at the receiving end.

Apart from writing a custom driver, probably the best thing you will be able to do is to first dump the screen to disk. Then output this picture using a suitable program.

Try Timeout Triple Dump or Printographer, both these will dump Apple II graphics to printers.

Perhaps someone else has a better solution?

**The Boffin**

Multilingual Services  
22 Charing Cross Road  
London

Dear Michael Corgan,

As a recent subscriber to Apple2000 I was intrigued to come across your letter in the October issue.

We have four //e Apples here, with varying amounts of AE RamWorks memory, and we use AppleWorks, v. 1.3, together with AutoWorks. At some stage we shall need to get a couple of more machines so your experience with the GS and AutoWorks is a timely warning.

I'm a bit late off the mark and I don't know whether I can be of any help to you, or any other business users who may have contacted you. After all, it would seem that you are the intrepid pioneer with your GS venture while I have stuck prosaically to what we have found to work extremely well, namely //e + RamWorks + AppleWorks + AutoWorks. This is not to say that I have no problems at all: firstly, I find the AppleWorks printing installation woefully inadequate as it won't allow me to get all the (to us) essential accents and continental characters on the daisy wheel of my Olivetti interfaced typewriters; secondly I find it a damned nuisance having to reboot every time I have to send a telex via Telecom Gold (despite noble assistance from Steve Morrisby of Bidmuthin I am still unable to load both AppleWorks 1.3 and the Access II comms. program into RAM).

If you think I can be of any help in any respect don't hesitate to get in touch.

**George Knapp**

□ We reprint George's letter to Michael Corgan with his permission.

Barbican  
London

Dear Sirs,

I have had a Brother HR-15 Printer for some years and it has given reliable service and required only one repair. I am reluctant to replace it, for the present anyway.

It serves as a printer for an Apple //e computer and is serially connected thus, the cable being provided by the dealer who has since gone out of business:

Printer Pin	Computer Pin
1	1
2	2
3	3
4	20
5	5
6	6
7	7
8	8
20	4

This configuration successfully from AppleWriter II (DOS 3.3), Quickfile II (Pascal 1.1) and Microsoft Multi-

plan (Version 106, DOS 3.3) -via an Interface Model 7710 of California Computer Systems set at 9600 Baud.

I have recently purchased AppleWorks marketed by Claris which is ProDOS based, and am unable to successfully print using the above configuration. I do not get a garbage output, but there is no line rationalisation and the format has random line lengths. Also each printout is preceded two lines earlier by all of part of the Control Code AppleWorks asks for configuring for a "Custom Printer" ie one which is not already listed in the programme.

Can you help? It has been suggested (a) a new interface card may be required and/or (b) the connection should be changed to parallel. In that case can you please indicate the pin connections in a listing similar to that above.

Further, will I still be able to print the original three programmes after the change? Any help or advice would be much appreciated.

**WP Goss**

□ First of all apologies for taking so long to print your letter.

Your CCS7710 card is a serial card. You have been using it this way with a serial connection to your printer, a parallel interface which is something quite different, would not in fact work with your printer at all.

The problem lies elsewhere. The CCS card normally issues a <CR> after 255 characters. I suspect that AppleWorks may be thinking that the printer is operating quite differently, and is sending line lengths that are triggering off the ragged line ends.

A further clue may be in that you see part of the printer initialising string on each printout. I suggest re-configuration of the printer in AppleWorks. There should be no control characters sent except for any mentioned in the Brother manual. Make sure the platen width matches that of the printer. From the <OA>O configuration menu, make sure the characters per inch again matches that of the printer as AppleWorks normally expects an ImageWriter which can print many different type widths.

If none of this works, please give Dave Ward a ring on the Hotline. He may be able to help further.

**The Boffin**

South Croydon  
London

Dear Ewen,

Congratulations on the "Hardcode Pips". I bought my //e when others were buying Lisa and I missed a lot of the early 'Pips' which the veterans may know about. I didn't know about BASUG those days and relied on 'Apple User' magazine.

Some more would be welcome.

**Michael Bass**



□ We intend "Hardcore Pips" to be a regular feature. Many of our newer members are new themselves to the Apple II.  
Ed. 

Cheltenham  
Gloucestershire

Dear Dave,

In response to your plea for Apple II repairers in Hotline News, the only possibility I know of besides those who advertise in Apple2000 is ESCO Computer Systems of 115 Burringham Road, Scunthorpe, South Humberside DN17 2DF, phone 0724-855795.

I have found the proprietor, Eric Sausse, most helpful, knowledgeable and sensible. His prices are reasonable too. He readily admits he is not an electronics expert and if he thinks a solution is beyond his capabilities he says so. If he thinks it is better to throw something away and replace it he recommends this. With prices where they are it is often cheaper to do this. On several occasions he has made suggestions which have enabled me to solve the problem myself.

He seems to have a pretty good supply of manuals at reasonable prices too, and generally his prices for cards and accessories are as low as any. Incidentally, Eric had a plug from another satisfied customer in the March issue of Apple Slices.  
Peter B Dyson 

Amersham  
Bucks

Dear Boffin,

I wonder if you can help me with any of the following:

1. With my recently acquired Apple II/e came the Apple Business Graphics program (2 disks, PLOT: and DATA:) and manual together with a disk (CONFIG:) that claimed to enable output from the program to be printed on an Epson printer. There were no instructions with this disk and I have not been able to work out how to access it from the main program, nor do I know which driver to use; consequently although I can run the program I am unable to print from it (my printer is a Panasonic KX-P1081 that seems to be fully Epson compatible). I would like to be able to use this program as in many ways it is more powerful than ApplePlot.

2. Is there a patch for the bug in AppleWorks 2.0 (and earlier versions) that causes it to crash to the monitor if you attempt to use OPEN-APPLE-S to save a file to a disk on which there is insufficient room?

3. I also acquired with the Apple an Owl modem and card, and Owl Appletel colour card and a Decca TV-style colour monitor (?type PN 781 RGB). There are manuals for the

modem and Viewdata editor but not for the Appletel colour card, so I do not know the settings for the dip-switches. Is it possible for me to use some combination of this gear to get a colour display from Apple Business Graphics, or games, on the monitor? At the moment all I can get are green and white.

David M.L. Morgan

□ 1. The program is written in Pascal. This requires that any printer should be placed in slot 1, and that the printer interface card conforms to Pascal protocols. You do not mention which printer card you are using, but you should find that most normal parallel cards will work with Pascal. From the listing you enclose, I cannot see any mention of a printer which is similar to the Epson. Perhaps someone else could help on this one?

2. I have searched the Open Apple magazines, the 'bible' of AppleWorks and other Apple II programmers, and cannot find a patch for this problem.

3. If I remember, the Owltel colour card is a Teletext chip driven card. If this is correct, it can only display Viewdata type displays, and cannot therefore display graphics as such. Perhaps someone can help with the dip-switch settings?

The Boffin 

Totland  
Isle of Wight

Dear Editor,

A comms. link which I wished to make, required DEC VT52 terminal emulation. To this end I purchased a Linnet/Gazelle combination, having received a verbal assurance from the vendor that it would suffice. Although able to access Prestel and Microlink easily, I have yet to see into the system requiring the VT52 emulation. Is there an obvious solution to the problem?

Finally, on boot-up from Mousedesk, the Selector screen is almost illegible, since the text comprises small block of colour. Is there a remedy?

Malcolm Tait

□ As the author of Gazelle, I am sorry to hear you were misled by the vendor. The manual explains how to set the program up for VT100. VT52 was an earlier and more limited version of this protocol, and is not entirely compatible with VT100. It was incorrect of the vendor to say it was. You will find VT100 more usually used on most systems these days. Gazelle cannot emulate fully VT52.

The solution to the second program is easy. Go to the Control Panel, select DISPLAY and change to Monochrome. This default setting is to make the normal hi-res graphic displays show as black and white rather than colour. It will not affect the super

hi-res colour screen. If you then run a program that should be in colour, but displays as black and white, simply change this back to colour.

Ewen Wannop 

Cameo Entertainments  
Sherwood  
Nottingham

Dear Sirs,

I'd like to ask if anyone can tell me just how to discover what the programmes available on the back of the Apple2000 introductory disk actually contain. It may be that they have lots of things useful to me and my Apple II/e, or maybe none of them would be of interest to me at all. Do you have any further details?

Also, I've just started using the very good programme Print Magic to produce posters for the clubs & pubs for which we supply acts. I also use Print Shop and Print Shop companion. I find that I can use P.S. Graphic disks with Print Magic, but I couldn't use the graphics from the Print Shop itself until I transferred them to a new disk, since when they work OK. I cannot find any way though of getting Print Magic to accept fonts and borders from Print Shop and Companion, which is annoying as I've customised most of them to get a £ sign on the fonts. I find the borders on the Print Magic a bit dull and boring in comparison to Print Shop & Companion too. I tried moving these on to a new disk as I did with the graphics from Print Shop, but Print Magic totally ignores them. Can anyone help with any suggestions?

Mavis Shardlow

□ The programs on the back of the Introductory disk are in fact AppleWorks word processing files. These were written under a large desktop, and so will need AppleWorks running with at least a 256k memory card if you wish to read or print them. They are normally read by the driving program. On the front or boot side of the disk, there are various programs. They are run when you boot the disk. There is however a Merlin text file of the actual program that will be of interest to assembly language programmers.

I throw open the Print Magic discussion to others who might help.

Ewen Wannop 

## APPLE IIGS LETTERBOX

Letchworth  
Herts

Dear Sir,

I have many points to mention, but first I feel some thanks is in order for everybody who assists in the production of the magazine: the layout is good, the articles interesting and the



tips useful.

I have a 768K Apple IIgs, with one disk drive and Revision 01 ROM. I recently constructed the Ensoniq input interface, for the Apple IIgs, by John Kishimoto in volume 3(5) of Apple2000, but have experienced some problems with it and the associated software. The actual circuit works and I can record and playback sound using the Tapedeck program, however, the quality of the recording is very poor; although I used a coax lead from the circuit to my input connector, the noise on the recording sometimes drowns out the music or speech. Also, I cannot save the samples with the Tapedeck program. If I select 'Save As' from the file menu, the usual dialog box comes up. I select the pathname (making sure the disk has enough room to spare) and click on save. The disk whirrs for half a second, the dialog box disappears and no data has been saved. I have tried using the program from both ProDOS and GS/OS, but neither works. What do you suggest?

I am in the fifth year of a local comprehensive, the Highfield School, and you may be interested in the events that have taken place there in the last month or so. The education standard computer in Hertfordshire seems to be the RM Nimbus, and our school is no different, having about 70 plus computers on two networks (we have 777 pupils).

Personally, I don't think very highly of them, so imagine my surprise when I went into the library one day at the beginning of March, and discovered 3 Mac SE's and 2 Mac II's there! A few enquiries revealed that they were there for a satellite link up with Japan. Here is a copy of the school press release:

#### **Highfield's Historic computer link with Japan**

*First year students at Highfield School are taking part in a unique and historic computer link up with children on the other side of the world.*

*Their faces and voices will be sent via specially installed personal computers, to a class of children in Toyama, on the northern coastline of Japan, particularly in school, and telling the Japanese children about life at Highfield School.*

*The children of both countries will be taking part in a Japanese television programme, sponsored by Apple computers, which aims to answer the question: 'When the children of two nations meet through the computer what do they talk about?'*

*The 38 minute program is scheduled to go out live on Japanese television on March 21, a national holiday.*

*This week teachers and children at the school have been busy preparing for the broadcast, mastering the newly installed computers (on loan from a British company) and compiling questions to be put to the Japanese chil-*

*dren.*

*The programme's director, who with his crew have been filming in the school and around Letchworth, says this is the first time youngsters in different countries have been able to speak to one another via a computer.*

The 'personal computers' installed are, of course, the Macs, with some associated hardware, namely an Apple scanner, ImageWriter II printer and modem. Hypercards are being used to transfer the data. I believe the 'British company' to be Apple UK, who are likely to be getting a lot of publicity out of the venture, which was arranged by a local hi-tech industry-education body, with large resources, called Education 2000. Rumour has it that some of the computers will remain at the school and I hope they do.

I also have some more praise for you, regarding the TML Pascal. After following your advice in February's issue, I phoned TML in Florida and managed to obtain version 1.50, even if it isn't posted straight away.

Finally, I think a few book reviews in the magazine would be quite useful, as it is nice to know what's behind a title. I look forward to hearing your comments and suggestions.

**Stuart Aitken**

Dear Apple2000

Looking back through the last years issues of Apple2000, I am convinced that the magazine is getting better and better. Being a little wary of attending the AGM at Luton, I was pleased to see the workshop work well and feel that it was well worth attending.

After talking to several people at the AGM, I have decided to try and get into comms. I read somewhere that you sell the Linnet 1200 modem reviewed in issue 3(3), which has hopefully not expired. You said you would send anyone who enclosed a large SAE a free guide to comms and TABBS. I have enclosed one, as I want to know what V21 and V22bis etc. mean.

With regard to my earlier letter, trying the DOC recording circuit from issue 3(5) with Tapedeck, sometime later, the problem of Tapedeck not saving the sound data has miraculously disappeared. In its place is a further problem: The article suggests using Sound Studio for editing sound. The program runs OK, but the sound from Tapedeck comes out totally garbled, what ever the playback speed. Have you any ideas? The program does work, as the sound file from the init file Startsound (the one that goes "Startsound, by Guy T. Rice") comes out perfectly.

Finally, I too have to report that many PD programs from the IIGS library crash on quitting under GS/OS. Is the only solution to wait for updates that are GS/OS friendly?

**Stuart Aitken**

□ The praise is overwhelming, thanks a million ...

I am not sure what is going on with your problems over using Tapedeck. However, I might suggest that it is due to you only having 768k of RAM. I would assume that Tapedeck would expect a full 1meg. It was one of the very earliest programs written for the IIgs. The poor sound quality using the DOC circuit may be due to mismatch of volume. The circuit that John described is quite fussy about the input levels, try putting a potentiometer into the circuit and adjusting that.

As to the problem with Sound Studio, I do not know the answer to your problem. You have tried using different speeds, so it can't be that. Perhaps it is also linked to the lack of memory as well.

Many of the PD programs were written in the early days. Most programmers were breaking new ground, and they may well have not cleaned up correctly on the ProDOS 16 exit routine. We shall all have to wait for better versions.

As an ardent comms man, I am glad you are considering getting into comms. The Linnet 1200 is still available from Apple2000, and represents one of the best buys in modems today. The free guide we publish is a very basic one. It may not answer all your questions. V21 is actually another way of describing 300/300 baud European style. V22 is 1200/1200 baud, and V22bis is 2400/2400 baud, both these are compatible with US versions of the same speeds.

We have no book reviews in the pipeline, but if anyone out there has read a book recently that they would like to comment on, we would welcome a review of it. Reviews need not be long, but they should be submitted on disk (or modem) if possible.

**Ewen Wannop** 

Thirlmere Drive  
Liverpool

Dear Ewen,

Belated thanks for your letter. I took the plunge and bought an Apple 20 mb hard disk and topped up the memory card to its full complement of 1 mb. Having no prior experience of using a hard disk, I thought it advisable to stick to the Apple version for a first purchase.

Cirtech are now marginally cheaper for the memory chips.

As you advised me, everything now runs a great deal better than before. I have put the SCSI card in slot 7 on the GS, and moved the PlusDisk (which contains AppleWorks) into slot 2. By leaving the startup slot as 7 (although scan would probably be just as good) I can start up from the hard disk by simply switching it on before I boot the system, from AppleWorks on the PlusDisk card by leaving the hard disk off, or from a disk placed in either



the 3.5" drive or the first 5.25" drive. The only problem now is where to put the Mastercard if I decide to use the modem again!

By the way, even with my enhanced setup, I cannot get a peep out of the sound demo program I mentioned in my last letter and the "moving landscape" demo still hangs up in the middle of part of the Finder screen, even after pressing Control-Reset as recommended. Perhaps some of the earlier programs just don't work with the new ROMs.

I have been very impressed with Jumpstart and am seriously considering sending off the fee and installing it as my startup program. As you say, it does read text files much better.

One odd thing that appears to happen when I use any of the library programs to print anything is that the ImageWriter does odd things if I try to print multiple copies from AppleWorks. What usually happens is that it prints part of it and starts printing the second copy without formfeeding etc. It took me a while before I found that the printer setting in the control panel had been changed to enable a printer buffer. Changing back to "No Buffer" instantly solves the AppleWorks problem. I can only assume that Jumpstart and at least one or two of the other library programs with printing facilities must change the setting to allow for a print buffer, as I have now had to change the setting back to unbuffered several times. Publishing this warning might save someone else the wasted time and concern that their ImageWriter has gone faulty!

The FontDoctor font editor only works with GS fonts and will only display fonts that have been installed in the System/Fonts folder. The author does say that he plans to enhance it to include, *iter alia*, the facility to edit Publish-It! fonts, so I will probably send off the fee and ask him if he has done this yet.

I have taken the opportunity to examine some fonts with the character swapping program, and was disappointed to find that the Publish-It! fonts do not appear to contain a £ sign at all. Interestingly enough, I could not find a hash sign in the library fonts that I examined in this way, although there is a £ sign. My next step will be to swap the £ sign in one of the library fonts you sent me to the position occupied by the hash sign in the Publish-It! fonts, change the file type and then see if it works. If it does, I will let you know as the information will doubtless be useful to others.

Did you see John Molloy's enthusiastic review of AppleWorks GS? He mentions that it will not print a £ sign, but seems to consider this to be a minor point. Frankly, I am at a loss to understand that view as this failure renders the program useless to me. He hints that the problem concerning the £ sign has its origin in the GS/OS

itself. He did have partial success in persuading the program to display a £ sign on the screen, but could not print it. Anyway, I can save £200 and stick to AppleWorks 2.0 for the time being in the forlorn hope that one day Claris might produce an Anglicised version. At least John Molloy mentioned the problem, the two reviews of Publish-It! I read before purchasing the program did not see fit to comment on the lack of the £ sign. I must admit that I still feel conned into buying a program that, as it stands, is really only suitable for the American market.

I wonder what slot I could use a PC Transporter card? At least there is a wealth of UK-written software which will run on that!

**Alan Willey**

□ I am glad that you are finding the Hard Disk useful, it has almost got to the point with the IIGs that a Hard Disk is essential to make the system work properly. The Macintosh is impossible to use without one, and in fact some programs for that machine are now too large to fit on a 3.5 floppy!

If you are not going to use the Mastercard and the Printer together, then put the Mastercard into slot 1 and simply switch the from the Control Panel as needed between 'Your Card' and 'Printer Port'.

Sound on the IIGs seems to be a variable event. I have heard of a few people having problems with it, whereas I have had none so far! There are indeed some of the early programs that will not work under GS/OS, I think we just have to accept that. However, JumpStart is not the only program to alter the Control Panel. This is going to be a continuing problem. Obviously ProDOS 8 programs like AppleWorks cannot know they are running on a IIGs, and so will not know things might have changed. Any programs that change the Control Panel should first save the parameters they find, and restore these on exit. Programmers please note!

The font problem will not go away easily. There is a legacy we have to live with in that the Fonts owe their structure to that of a Macintosh Font. The Macintosh uses 256 character positions, and puts all the 'funnies' into the top 128 with the 'hi-bit' of the word set. This means that any word processor must be able to handle 8-bit data. In transferring these fonts to the IIGs, the £ sign and other useful characters will be in these top 128 positions. It is usual in ProDOS word processors to only handle 7-bit data, thus hiding these characters from view. The Font editors simply redraw or swap these characters to make them visible. However, unless the printing is done by means of a bit mapped image, the characters will still be elusive. The ImageWriter will print them for instance where the LaserWriter will not.

Some of the Font Editors and char-

acter swapping programs are decidedly flaky, and should be used with caution.

We have not given a review of AppleWorks GS yet for various reasons. It is very slow, it cannot see the full font set as you mention, and it needs 3.5 mb to be able to load large files you may already be using in standard AppleWorks. For the meantime, I do not think it is a viable alternative.

**Ewen Wannop**

**Arlesey  
Beds**

Dear Sir,

My IIGs currently does not have the Version 01 ROM. Can you supply this or do you know of somebody who can?

**Colin Staple**

□ I have had quite a bit of correspondence on this matter and the SCSI ROM upgrade. Malcolm Tait was quoted £90 to exchange his system ROM and R. H. Devitt was actually charged around £57 for upgrading his SCSI ROM by his local dealer.

The upgrades are necessary if you are to use the current GS/OS operating system for the IIGs.

The position is this. Apple will replace the VGC and system ROM of a IIGs free of charge to the current revision level if necessary. You should also have a free upgrade to revision 2.0 (C ROM) of a SCSI card. It is up to you to pay any charges involved in getting the machine to your dealer. He is entitled to make a charge for labour, but this is unusual. Apple sell the ROM upgrade kits to the dealers, but credit the dealer on return of the old ROM's. For this reason, it must be an exchange. You cannot get the ROM's in advance.

However, Apple UK have failed to tell many of the dealers how the exchange operates. Consequently, they are charging for this service. There should be no charge whatsoever if you go back to the dealer you bought the machine from. Persevere, and make sure you are not charged for the upgrades.

After writing to Apple themselves, R.H. Devitt got his money back from his local dealer.

Apple UK are not being very helpful over the IIGs. Apart from the total lack of advertising, they are not for instance providing the GS/OS system disks for existing users. It has been left to the User Groups to distribute these disks to their members. Officially we have not received these disks from the UK, we have had to obtain them from the States. If you are not a member of Apple2000, you will have to rely on a dealer who may or may not have these disks, and may or may not give you a copy!

Come on Apple, wake up to the IIGs. It does exist you know!

**Ewen Wannop**



# C

## Dave Miller continues with his definitive series on languages

In this instalment I shall cover C, an ALGOL-descendent which has gained much popularity in the last few years but dates from the mid-70s. Reference is made to ALGOL and Pascal and the relevant articles in Apple2000 Magazine should be consulted where necessary.

During the ten years following the publication of the 'Revised Report on the Algorithmic Language ALGOL-60' by P Naur, in 1963, several new languages were devised, among them were ALGOL-68, Pascal (both already covered in Apple 2000 Magazine) and CPL (Combined Programming Language - so called because it was intended to be applicable to all types of problem: numeric, textual, logical, etc). CPL was a joint venture between the University of London Institute of Computer Science and Cambridge University Mathematical Laboratory. It was never fully implemented but a reduced form, called CPL1, was implemented on the Atlas computer. CPL led to the development of several systems programming languages, the most notable of which are BCPL (Basic CPL), B and C.

All the languages developed from CPL share ALGOL's main concepts and the resemblance can be easily recognised. Another common feature is that these languages generally produce highly optimised machine code. Features are provided for the programmer to specify statements in the most efficient manner. Thus these languages are ideally suited to systems programming work where efficient code and the benefits of a high level language are required.

C was designed by Dennis Ritchie as the programming language for the UNIX operating system. In fact much of the operating system is actually written in C. Although many implementations of C now exist outside of the UNIX environment (e.g. versions for the Apple //) most implementations are still under UNIX. The nearest thing to an official definition of C is 'The C Programming Language' by Kernighan and Ritchie, published by Prentice-Hall.

### SOURCE FORMAT

Like Pascal, C adopts free-format source files and spaces are used to delimit keywords and variable names. C differs from Pascal in two major

respects: C is case sensitive - so "Fred", "FRED" and "fred" are all regarded as different. Also the semicolon is a statement terminator in C, and not a statement separator, as in ALGOL and Pascal. Thus all statements should end in a semicolon in C. This last difference has caused many an upset programmer to tear his/her/ (its?) hair out because it is easily forgotten when using, say, C and Pascal!

Comments in C are delimited by /\* and \*/.

### BLOCKS

Blocks, as defined in ALGOL, are fully supported in C. The braces, '{' and '}', are used to delimit blocks in the same way as the keywords 'begin' and 'end'. Why braces were adopted is beyond me because they are most inappropriate: they can easily be overlooked when inspecting source code. A block counts as a whole statement, including a terminator, and so does not have to end with a semicolon.

### VARIABLES

C is a typed language. Two main types are supported: integer numbers and real numbers. Integers are split into 'char', 'short int' and 'long int' which are usually 8, 16 and 32 bits long. Since all these are integers, they can be freely mixed in expressions (yes, even 'char'). Integers can also be labelled as being 'unsigned' which allows all the bits in the variable to be used to store a value (i.e. the most significant bit is not a sign bit). So a 'char' can store numbers in the range -128 to 127 (7 data bits plus one sign bit) whereas an 'unsigned char' can store numbers in the range 0 to 255 (8 data bits). Reals are split into 'float' and 'double' which are usually 32 and 64 bits long respectively.

e.g. some simple variable definitions:

```
long int  ll, 12;
          /* two variables ll and 12
           defined */
char      c;
float     f;
double    d;
int       i, j, k;
          /* short int */
```

### STORAGE CLASSES

All variables have an associated storage class. This indicates the way in which the variable is stored in memory. Unless otherwise specified, variables are automatic. This means that they are local to the block in which they are defined and only exist while that block is being executed. Other storage classes are:

#### static

Static variables are constantly maintained. Thus a static variable will maintain its value after the block in which it was defined has been exited. Static variables are initialised to zero by default.

#### external

External variables are defined in other blocks or modules (by definition they are also static). Thus variables from one block/module can be accessed by another.

#### register

This is an optimisation feature. A variable can be explicitly bound to one of the CPU's registers if allowable. Obviously this is a machine-dependent feature.

With prudent application this can speed up the execution time of a program considerably. By definition register variables are automatic.

#### typedef

This is, effectively, a type definition. e.g:

```
typedef unsigned char byte; byte c;
```

The above two statements define the variable "c" as a "byte" which is an "unsigned char" (i.e. an 8-bit number without a sign bit).

### VARIABLE INITIALISATION

Static variables may be initialised when defined:

```
static float x = 3.5;
static int   i = 3, j = 2;
static char  c = 'a';
```



### ARRAYS

e.g.

```
float vector[20];
int matrix[10][10];
```

Here "vector" is defined as a floating array dimensioned from 0 to 19 (i.e. 20 elements long) and "matrix" is defined from [0][0] to [9][9]. Note that the array always starts at index 0.



Bidmuthin's Latest

# TransWarp-GS

**More than double the speed  
of your GS**

**+**

# AppleWorks-GS

**Full Colour DTP and More**

**TOGETHER -**

**£499.00 + VAT**

**Bidmuthin Technologies Ltd.**

**Brent House**

**214 Kenton Road**

**Harrow**

**Middlesex HA3 8BT**

**Telephone 01-907 8516**

**Apple Authorised Dealers**

**Level 1 Service Centre**

**Apple // series & Mac**



The array identifiers are actually pointers which address the first element of the array. The index specified is an offset to be applied to this pointer (hence arrays start at index 0).

Arrays may be initialised (they are zeroed by default):

```
int n[3]      = {1, 2, 3};
int matrix[2][3] = {
    {1, 2, 3}
    {4, 5, 6}
}
```

In the second example matrix[0][0] is 1, matrix [0][1] is 2, etc.

**character arrays**  
e.g:

```
char str[10], text[] = "this is a text string";
```

Note that 'text' is defined without a length - this is taken to be the length of the text string. Text strings are delimited by DOUBLE QUOTES. No length information is stored - the end of the string is marked by a nul (zero value) thus there is no theoretical maximum string length (although different implementations may impose some practical maximum size). Non-printable control codes may be included in the string using the following editing characters:

```
\n new line (carriage return and line feed)
\b backspace
\f form feed
\r carriage return (without line feed)
\t tabulation
\xn n = hexadecimal character code
\o n = octal character code (e.g. \7 = CHR$(7) in BASIC)
\e escape
```

also

```
\' includes a single quote in string
\" includes a double quote in string
\\ includes a back-slash in string
```

e.g:

```
char example[] =
"test\n\'test\'\ntest\r\r";
```

If this were printed then the following would be output:

```
test
'test'
rest
```

## STRUCTURES

Structures are C's equivalent to Pascal's records. A structure has members. For instance, a payroll record may have the following members:

the employee's name, his/her payroll number and the date of his/her joining the company.

This could be defined in C as:

```
typedef unsigned char byte;
struct payroll
{
    char    name[20];
    long int paynumber;
    byte    joiningyear;
    byte    joiningmonth;
    byte    joiningday;
}
```

```
struct payrollperson id[20];
/* array of 20 structures */
struct payroll id = {"Fred",
112039, 88, 3, 30};
```

Here two variables have been defined: 'person\_id', a 20-element array of structures and 'id', a single record which is initialised. Accessing the members of a record is achieved by appending the member's name to the structure's name with a full-stop between: in the above example accessing 'id.fred' returns 'fred'.



## ASSIGNMENTS

These are pretty straight-forward (note the use of '='):

```
x = y;
```

Some special assignments are possible:

```
a+ = b; /* -> a = a + b */
```

```
even:
```

```
x+ = y+ = 3; /* -> y = y + 3; x = x + y + 3 */
```

Note the different meanings of '=' and '==': the former only assigns values and the latter only tests for equality.

## SUBPROGRAMS

C, like ALGOL-68, only has functions which return a value. Certain functions are of type 'void' which indicates that no value may be returned (the nearest equivalent to a procedure). Parameters are specified in parentheses which must be specified even if there be no parameters required.

e.g. the following integer function sums 'a', 'b' and 'c' and returns the

result:

```
int sum (a, b, c) /* calculate
the sum of the three parameters */
int a, b, c;
{
    return a + b + c;
}
```

This is called thus:

```
int result, a, b;
...
result = sum (a, b, 4);
```

If a function is not invoked in an expression returned result is discarded.

e.g:

```
sum (a, b, 4);
This call to 'sum' would call the function and then ignore any returned result.
```

## STATEMENTS

C has the usual set of statements:

### goto statement

This is an unconditional jump:

```
label :
....
goto label;
```

Note that alphanumeric labels are supported.

### conditional statement

This allows conditional branching:

```
if (expression) statement;
```

or:

```
if (expression) statement; else
statement;
```

Note that there is no 'then' keyword. Also note the semicolon before the 'else'.

### loops

Looping is performed via three types of loop:

```
while (expression) statement;
```

Here the expression is tested before the statement is executed, so there is a chance of not executing the statement at all. Looping ends when the expression returns zero (false).

```
do statement while (expression);
```

Here the expression is tested after the expression so the statement is always executed once. Looping ends when the expression returns zero (false).

```
for (exp1; exp2; exp3) statement;
```

exp1 is executed only once when the loop is started, exp3 is executed repeatedly after the controlled statement while



exp2 remains true (i.e. non-zero)

This is equivalent to the following while loop:

```
exp1;
while (exp2)
{
    statement;
    exp3;
}
```

e.g:

```
for (j = 1; j < 11; j++) /* j++
    increments j */
    dosomething (j);
```

The Pascal equivalent is:

```
for j := 1 to 10 do dosomething
(j)
```

The 'break' and 'continue' statements can be used with loops: 'break' exits the loop and executes the first statement past the end of the loop whereas 'continue' jumps to the position just before the evaluation of exp3.

Each of the expressions may be omitted:

```
for (; j < limit;) ...;
    /* loop while j < limit */
for (;;) .....;
    /* loop forever */
```

#### switches

Switches provide C's equivalence of Pascal and ALGOL's case statement:

```
switch (exp)
{
    case 1 : exp_is_1;
    case 2 : exp_is_2;
             exp_is_still_2;
             break;
    default :
             exp_is_not_1_or_2;
}
```

If the default prefix is omitted then the switch is exited on no match. Note the use of 'break'. This causes the switch to be exited after the statements 'exp\_is\_2' and 'exp\_is\_still\_2' have been executed. The previous match (with 1) lacks a 'break', this means that execution continues unimpeded through the remainder of the switch after statement 'exp\_is\_1' has been executed.

#### STATEMENT EVALUATION

Like ALGOL-68 all statements can 'yield' a value. Hence 'x = 2' actually yields the value 2 (this is why 'x = y = 2' is valid: 'y = 2' assigns 2 to 'y' and yields the value 2 which is assigned to 'x'). This is why all subprograms are functions.

Full use of this feature can produce very efficient (but sometimes rather obscure) code. The following while loop copies data from one part of memory to another until a zero item is met:

```
while (*s++ = *t++);
```

The '\*' is an indirection operator and forces C to interpret the contents of the associated integer as a memory address and not as a value. The '++' increments the associated variable, if placed before the variable, it is incremented before its value is examined, if placed after the variable, it is incremented after it is examined:

```
a = 2;
b = ++a; /* a = 3 and b = 3 */
a = 2;
b = a++; /* a = 3 and b = 2
         since a incremented after
         assignment to b */
```

The while loop is equivalent to:

```
(register int val; /* val
    is register variable */
loop:
    val = *t; /* get value
             of location addressed
             by t */
    if (val != 0) /* '!='
                 means not equal to */
    {
        *s = val; /* save
                 in destination loca
                 tion */
        s = s + 1; /*
                 select next locations
                 */
        t = t + 1;
        goto loop; /* loop
                 again */
    }
}
```

Not only is the first example far more succinct, but the code produced is more efficient since 'val' will always be a register variable but it may be allocated store in the second example if register storage mode is not allowed or if the compiler thinks that no registers are free.

#### MACROPROCESSOR

One of C's most powerful features is the compilation-time macroprocessor which it shares with languages like CORAL-66. This allows macrodefinitions (like abbreviations) to be defined and undefined during compilation. Thus:

```
#define pi 3.14159265358979
....
#undef pi
```

In between the define and undef compiler directives any reference to 'pi' is substituted by the string '3.14159265358979'. Note that semicolons are not used since these are compiler directives and not C program statements.

One useful application is to redefine those pesky braces to 'begin' and 'end':

```
#define begin {
#define end }
```

Thus the following would be valid:

```
for (j = 1; j != 20; j++)
begin
    do_something();
end
```

This looks far neater than:

```
for (j = 1; j != 20; j++)
{
    do_something();
}
```



#### CONCLUSION

C is a rather tricky language. It lacks some of Pascal's tidiness (for some reason virtually all C listings appear messy to me no matter how much attention the programmer has paid to source code layout! - I blame the adoption of braces as the compound statement delimiters). C is, though, a real language, designed from the outset for systems programming work in real environments, not for teaching, and it is supremely suited for this task.

C is very powerful and has many advanced features such as bit manipulation, expression yielding and special function evaluation facilities. Many of these features come from CPL and allow C to produce optimised machine code for applications solving many different types of problem.

The power of C is indicated by the fact that many of the latest C compilers, if given suitably written code, will produce machine code almost as good as a competent programmer using assembler.

C also has an almost uniform set of library routines which provide such facilities as file handling and trigonometric functions.

Programmers are beginning to use C for more general applications and, with the spread of UNIX systems, the popularity of C will increase. It looks unlikely that C will displace Pascal but it should be some major rival.

In the next installment I shall be going backwards in time and covering our old favourite, BASIC.

DAVE MILLER



□ We did not have room in this issue to publish the usual programming example provided by Dave Miller.

□ The full set of articles by Dave Miller published in Apple2000 so far covers:

Introduction	August 1987
Fortran	October 1987
Cobol	December 1987
Algol	June 1988
Algol-60	August 1988
Algol-68	October 1988
Pascal	February 1989



# Controlling the Real World

## Bill Hill tells us how to automate the central heating system and keep the baby warm

### INTRODUCTION

Before you dismiss the Apple II+ or //e as obsolete, think for a moment about what the Apple 2 series is: a simple, highly expandable computer. Where am I leading? Well, since the software and hardware of my //e are much less sophisticated than those of the fancy 16 and 32 bit machines on the market today, I thought I would not have too much trouble converting it into a smart central heating controller for my house. This article describes how I did it, and I hope that you will be convinced that it is not all that complicated. An added benefit is that the hardware and software that I describe here can very quickly be modified for use in controlling many other things, e.g. motors, lights etc.

Before I launch into describing the hardware and software that I produced, I will explain a bit about my central heating system and the reasons why I wanted to improve the existing control scheme.

My house has an old gas-fired central heating system. It is the sort where you cannot have just hot water; the radiators upstairs warm up whether you like it or not (unless you turn them off at the valve, of course!). An electric pump, controlled by a wall-mounted thermostat, is used to circulate water round the radiators. The wall thermostat is in the living room, so all I could do was control the ambient temperature in that room to any degree of accuracy.

The boiler was controlled from the typical wall-mounted time clock; the usual old fashioned sort, with knob to select the mode (e.g. water + radiators two times a day) and two sets of on/off tabs. The only means of controlling the water temperature in the hot water tank was by adjusting the boiler thermostat. The only means of controlling the ambient temperature was by the wall thermostat (which switches 240V mains).

Parents among you will know that some thought has to be given to getting the room temperature just right for a new baby. I therefore wanted to see if I could come up with a good way of controlling the temperature of the baby's room. I also wanted to control the temperature of the hot water tank

- the boiler seemed to fire far too often for my liking. I wanted to achieve both these aims but still be able to switch back to the old control system whenever I desired.

To control the ambient temperature in the baby's room, one could fit a thermostat in that room and/or fit thermostatic valves to individual radiators. To control the hot water tank temperature better, one could fit a thermostat directly to the hot water tank. (In fact, one could fit an electrically controlled valve to isolate the hot water circuit from the radiator circuit in order to get hot water without heating the house, and vice-versa. A suitable control box would of course be needed.)

I did not want to go to the trouble of fitting an electrically controlled valve to isolate the space and water heating circuits, so that ruled out independent control of baby room temperature and hot water. Still, there was nothing to stop me fitting thermostats to both and selecting which one to control at any given time. However, I was not sure how fine a level of control I would get using the standard bimetal thermostats available from plumbers merchants; mains wires all over the place was not an attractive proposition, and I didn't fancy the palava of having to use transformers. Also, I wanted a controller that would allow me to have all sorts of time settings, and perhaps a few other features as well: a max-min thermometer would be nice since my main concern would be to control the temperature accurately in the baby's room.

So there you have it. To sum up, I wanted to control the ambient temperature in the baby's room, control the hot water tank temperature, and have a controller with max-min readings, lots of programmable on-off settings and plenty of flexibility. Oh, and I didn't want to add any new electric valves to my pipes or do any rewiring of the existing system. The latter was very important since I wanted to be able to take the new controller with me if I moved house, and still leave a working central heating system. Now perhaps you can see why I thought about using the old Apple!

I therefore decided to use the Apple as a 'supervisory controller', i.e. it would switch the power on or off to the existing control system, rather than replace it. The Apple is thus effectively acting as my proxy - it keeps an eye on either the baby room temperature or the hot water temperature and takes the appropriate action. I still have use of the wall-mounted thermostat in the living room, which can be adjusted ('tuned', to use the jargon) to produce the desired overall performance with the new control system, or used as it was originally intended, i.e. to regulate the temperature in the living room.

### REQUIREMENTS

I needed three things in order to use the Apple as a central heating controller. Firstly, a means of measuring the temperatures, secondly a means of calculating whether to turn the heating on or off, and thirdly a means of actually switching the mains to the boiler and pump. The first task can be done with transducers (also known as sensors), the second by software, and the third using a relay. Most of the hardware can be mounted on prototype cards that can be plugged into the Apple's slots, as you will see. Since the system works in real time (i.e. I want to be able to tell it to come on at, say, 6 am), then a clock card is also needed since the Apple 2 does not have a built-in real time clock.

### MEASURING TEMPERATURES

Now, as it happens, there are cheap solid state temperature transducers widely available. Not only that, but they are linear, unlike thermocouples. That is to say, the voltage they produce is linearly related to the temperature (crudely put, if the temperature doubles, the voltage doubles). The particular variety that I decided to use was the LM35DZ, which produces 10 millivolts per degree Centigrade rise, over the range 0 to 100 degrees. In my case the working range would be, say, 0 to 25 degrees for the baby's room and 0 to 70 degrees for the hot water tank. Thus, the temperature transducers would produce up to 25 mV and 70 mV respectively.

The voltage from the transducers needs to be converted to a binary number that the computer understands. This process is termed 'analogue to digital conversion', A-D for short. These days you can buy cheap A-D converters on a single chip. They usually only need a small amount of ancillary electronics to give you a working system. What's more, they often have more than one channel - eight is usual - i.e. you can convert eight separate analogue inputs to eight separate digital values.

I opted for the ADC0808, a cheap 8 channel, 8 bit A-D converter chip. By '8 bit' I mean that the chip will convert an analogue voltage into an 8 bit



integer number. Since the range of integer numbers that can be represented by eight bits is 0 to 255, and the ADC0808 expects inputs in the range 0 to 5 volts, zero volts into the converter will produce binary 00000000 on its output data lines while 5 volts will give binary 11111111 (i.e. 255). Figure 1 shows the complete A-D converter circuit. The ICs are as follows:

NUMBER	TYPE	+5V	GND	+12V
IC1	ADC0808	see figure 1		
IC2	74LS00	14	7	
IC3	LM301	4	7	
IC4	74LS02	14	7	
IC5	74LS30	14	7	
IC6	74LS04	14	7	

Since the output from the transducers is in millivolts, I needed something to boost their voltage to the 0 to 5 volt range needed by the A-D converter. This is done using operational amplifiers ('op amps' for short). An op amp, in conjunction with a couple of resistors, can be configured to give a gain of your choosing. The idea was thus to make two amplifiers with different gains in order to boost the the two transducer voltages to fit into the range 0 to 5 volts.

I decided on the LM324 chip which actually contains four op amps, so two were unused. The only problem was that the LM324's output voltage saturates at about 3.8 volts. This limited my range into the A-D converter to 0 to 3.8 volts. Ideally it would have been better to get an op amp that would allow me to boost the transducer voltages such that their maximum likely outputs would be amplified to 5 volts, but the hardware limitation of 3.8 volts was not too bad. At 50 pence for the LM324 I was not going to grumble too much!

I mounted the A-D circuitry on a Vero prototype Apple card, which can be plugged into any slot (you can buy these Apple prototype cards from Verospeed, MGA Softcat, etc.). The op amps and the digital switching circuitry are on another prototype card which can be plugged into another Apple slot. The two transducers are connected to the amps by long leads laid under the carpet so that they are unobtrusive. The leads have three wires: one for ground, the second for the 5 volts to supply the transducer, and the third for the transducer output voltage. Since the A-D converter has eight channels, I connected the amplified baby room output to four of the A-D inputs, and the amplified hot water tank output to the other four. I could then average the four readings in software. A program can use PEEKs to read the converted voltages.

#### SWITCHING THE MAINS

So I had sorted out how to get the temperatures converted into numbers in the correct range for the Apple to understand. The next stage was to

work out what hardware would be needed to switch the 240 volt mains needed by the boiler and the pump. Since the Apple's circuits use 5 volts to represent logic 1, and zero volts to represent logic 0, you will appreciate that you don't want 240 volts anywhere near the inside of the machine! I therefore decided to switch a low DC voltage inside the Apple, which would then switch a mains relay in a separate box well away from the computer. Since the Apple is upstairs and the boiler is downstairs, this also allowed me to sleep easy at night knowing that my two year old daughter would not electrocute herself if she decided to cut the flex with her "snissors" (although I have gone to the trouble of hiding the flex anyway, both for safety and for aesthetic reasons). The switching circuitry in the Apple is mounted on the second Vero prototype card.

You may have heard of 'solid state relays'. These act just like old fashioned relays, but instead of energising a coil to open/close the switch, the solid state relay does the job electronically, using light would you believe. They also have additional internal circuitry designed to reduce noise on the mains when you switch something on (I won't bore you with the details!). These 'opto-isolated solid state relays' are very safe, can switch high currents at mains voltages millions of times without failure, and are cheap. I opted for the FR Electronics ZRA 6010A which will switch 240V at ten amps (way above the 2 amps that I needed, but I like a nice beefy piece of equipment with plenty of spare capacity!). This little beast cost about eleven pounds. A DC voltage of anything between 3 and 24 volts will cause the relay to switch the mains on.

I used a different relay to switch 6 volts DC to energise the external power relay. This relay was mounted on the same card as the two op amps. I could have gone for another, smaller, solid state relay. However, there is a cheap reed relay available that is directly TTL compatible, that is to say, it can be driven by the Apple's binary on-off voltages of 5 or 0 volts. This relay (FX88V from Maplins) only costs a couple of pounds and also has a long life. The 6 volts DC that I use it to switch is produced by one of these dirt cheap (about two pounds) power supplies that can be bought for use with cassette recorders etc. This power supply is housed in the same box as the power relay. The box is aluminium so that it can double as a heat sink, although in fact the heat generated by the relay and the DC power supply is very small. They are bolted to the inside of the box to increase heat transfer, and I have drilled ventilation holes in the box. I hasten to add that the box is of course very well earthed, fused, and the wiring inside is carefully laid out and soldered onto

isolated terminal blocks so that there is no risk of a wire touching another. The safety aspect of these things has to be well thought out when dealing with mains voltages.

The final pieces in the electronic jigsaw are a 74LS04 logic inverter chip and a 74LS74 flip-flop. These are mounted on the same card as the op amps and the reed relay. I use these to latch a binary signal from the Apple's bus in order to switch the reed relay on and off. I won't bore you with the details, but basically I use the DEVICE SELECT line and address line A0 on the bus. By PEEKing or POKEing to an odd numbered address in the I/O range for the slot that I use, I close the reed relay. By PEEKing or POKEing to an even numbered address I open the reed relay. This method is by no means the only way of doing it, but it is simple. I could even have used the games port to drive the reed relay, but decided that things would be neater all laid out on a card in a slot.

Figure 2 shows the circuit diagram for the second Vero prototype card with the op-amps, reed relay and the address decoding logic. Figure 3 is a schematic diagram of the overall switching circuit.

#### CHOOSING A CLOCK CARD

The only other hardware that I needed was a real time clock card. Not having one, I decided to purchase the U-CCT card that U-Micros were selling cheaply to get rid of their stock (they no longer make this card). However, when I tried to write a general purpose 'suspend for time' routine, I discovered that this card has a bug in the firmware which affects the decade digit of the seconds field. It is the sort of thing that would not cause any problems for 99.9% of users, but for the particular job I had in mind it was annoying. I could have 'coded around' the problem, but after pointing out the problem to U-MICROS they offered me my money back and I bought a secondhand TimeMaster HO. This is a super card and has given me no problems at all.

#### THE SOFTWARE

The final hurdle was to write the control software. Since the program was going to be relatively long, I decided to use Apple Pascal rather than BASIC. This was partly to force me to learn Pascal, and partly because Pascal is by far the better language and would increase the likelihood of me being able to understand the program in six months time! Because of the size of the program I have had to make some of the procedures into 'include' files. The main program is CONTROL.TEXT and the separate 'include' files are SETUP.TEXT, READCLOCK.TEXT, DISPLAY.TEXT and TIMEDELAY.TEXT.

Rather than use interrupts, I opted to write a simple 'suspend for time'

type of procedure, i.e. a procedure that I could call with a parameter specifying a time delay and which would only return after the time had elapsed. Basically, the program reads the temperatures, calculates whether they are above or below the set-points and switches the mains on or off accordingly. It then waits for five minutes and repeats the process. I have built some hysteresis into the program so that it is not constantly switching the mains on and off.

For fun, I have added a few bells and whistles to the program. Since there is some noise in the measurements, the program filters the noise digitally using the Kalman filter algorithm (why use a Metro when a Ferrari will do?). I have also added 0.1 microfarad capacitors across the op amp inputs to filter the measurement noise, which is quite large for long lengths of lead. Since I am using four channels to read one voltage, the program averages the four values. To make things more interesting, the program checks the four values to see how close to each other they are. If one is significantly different from the other three then the program excludes it from the average. The program uses a slick method called the 'degree of inconsistency' to do this. If the degree of inconsistency is greater than a threshold value for the four measurements then the program sounds an alarm to indicate that there has been an input failure of some sort.

The program stores all the current

set-points and time settings (up to twelve on/off settings per day are allowed) on disk. If the power fails and comes back on later, the program will run automatically and, if no key is pressed within a given time, will read the data off disk and carry on as before.

Since the Pascal software supplied with the clock card didn't do quite what I wanted, I have written my own driver. You may find this useful in other applications. Likewise, the PEEK function and POKE procedure in the program are generally useful if you don't already know how to do this in Pascal.

I have not bothered with any error trapping of user input as yet, and I am toying with the idea of adding various other functions to the program, time permitting.

### RESULTS

Well, does it work? The answer is: yes! The system has been running for six months now without any problems. After some initial scepticism, my wife now uses the system quite happily, changing the set-points and selecting either control of the temperature in the baby's room or the hot water temperature. The performance so far indicates that the new system will cut down the gas bills during late Autumn and early Spring when outside temperatures are not ultra low. During Winter months when the temperature is particularly 'brassy', the new system does no better than

the old system since the boiler needs to work full tilt to keep the house warm and provide hot water. I will be monitoring my gas bills over the next year to see how much I have saved. Since the overall cost of the project has been about one hundred pounds (including clock card), I'm sure that it will take a couple of years to pay for itself. However, it was great fun to make, and a good learning exercise.

You may have realised that, as the hardware stands, it is simply a computer-controlled electric switch. With the appropriate software it could therefore be used to switch anything on and off. The design also allows for expansion; an extra reed relay could be added on the same prototype card, and this could be used to control another remote power relay box.

Finally, I would just like to say thanks to the following people: Simon Manners for his advice on the solid state relay and aluminium box idea, to Craig Powers for advice on op amps, and to Roddy MacKenzie for his comments on my misuse of Pascal!

Bill Hill

□ The Pascal text file listings were too large to include in the magazine. They can be found however on TABBS for downloading. Anyone who wants a copy of the original disk should send a blank 5.25 disk with return postage marked "PROGRAM HEATING CONTROL" to Apple2000, PO Box 3, Liverpool, L21 8PY. Ed.

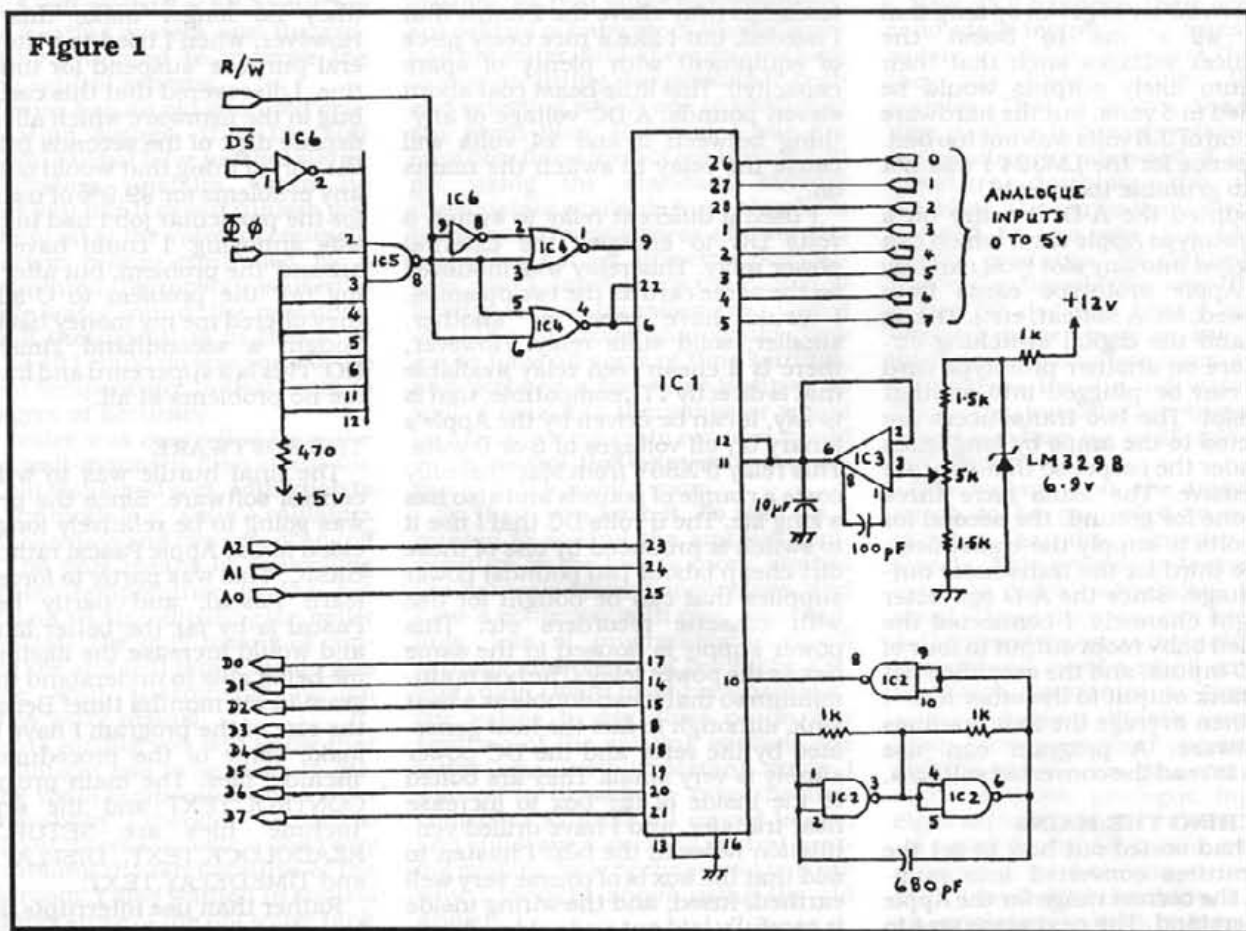



Figure 2

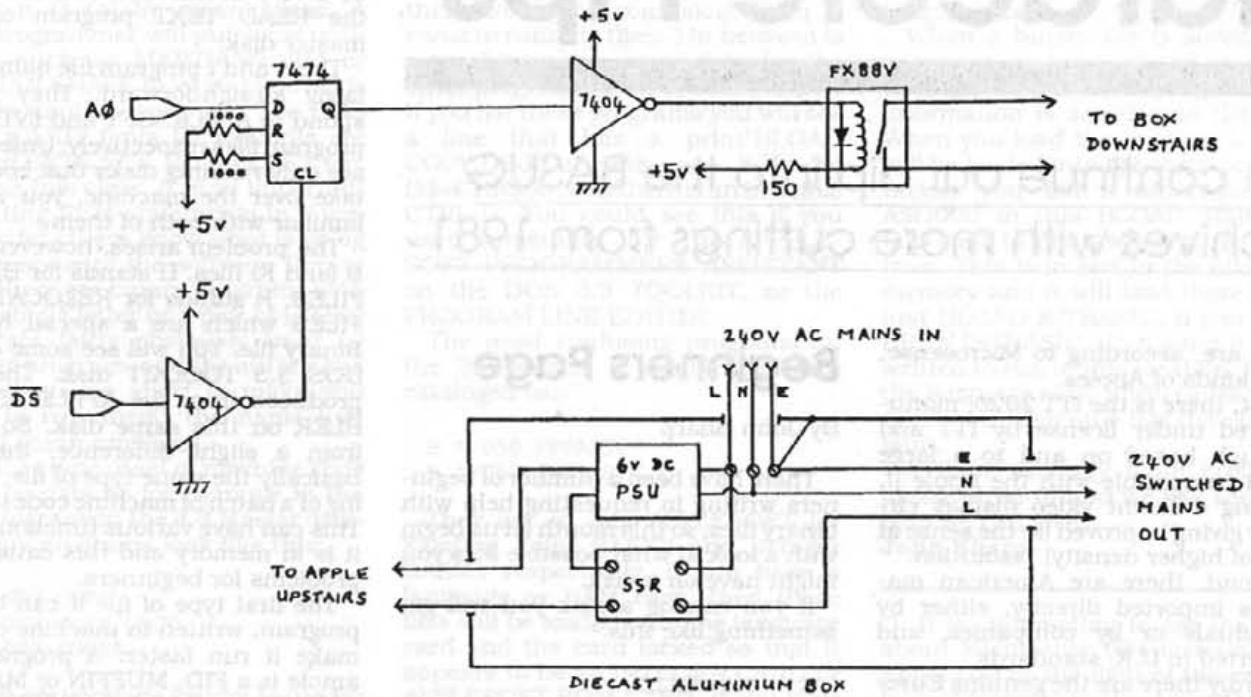
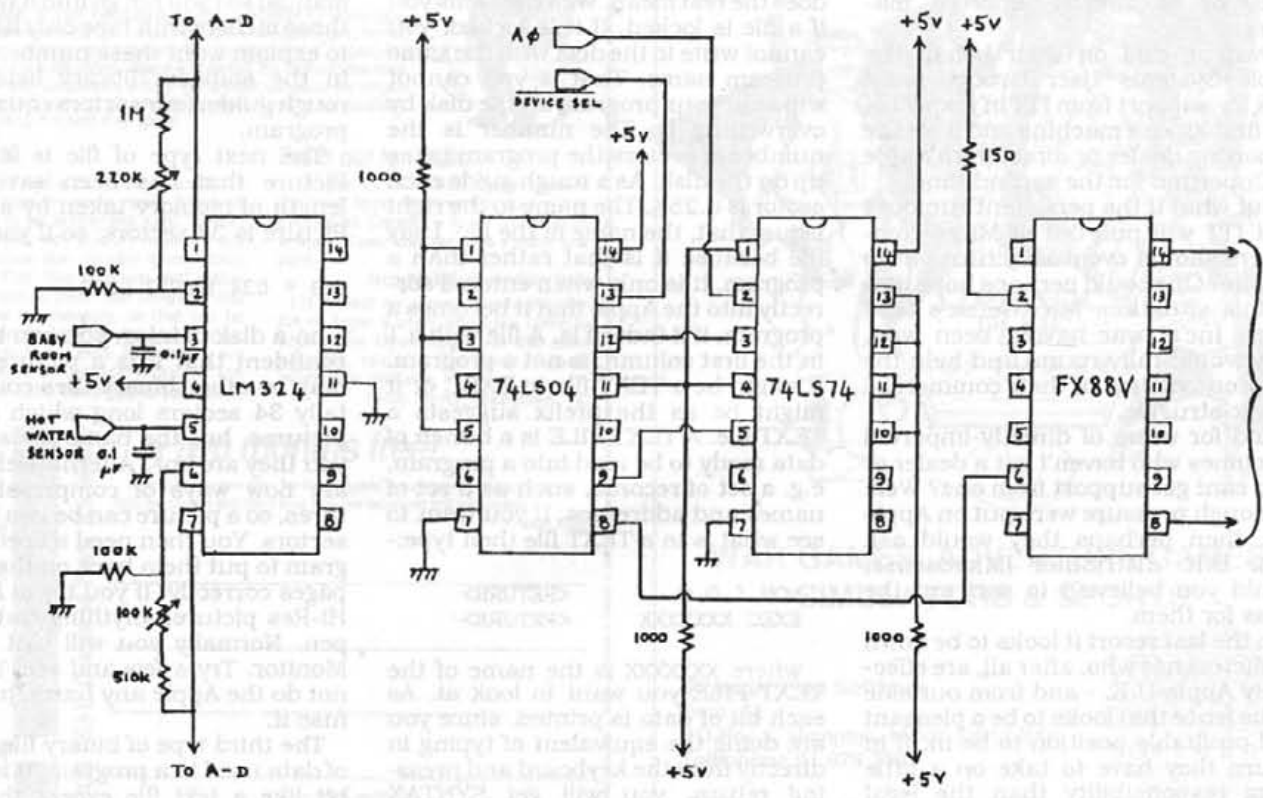

Figure 3



# Hardcore Pips

We continue our dip into the BASUG archives with more cuttings from 1981

There are, according to Microsense, three kinds of Apples.

First, there is the ITT 2020, manufactured under license by ITT and although based on and to a large extent compatible with the Apple II, utilizing different video display circuitry giving improved (in the sense at least of higher density) resolution.

Second, there are American machines imported directly, either by individuals or by companies, and converted to U.K. standards.

Thirdly there are the genuine Euro-plus Apples, manufactured to U.K. standards by Apple Inc., and sold via Microsense and their approved dealer network.

Microsense are a commercial organisation and, not unreasonably, want to promote the sales of the third kind of Apple at the expense of the other two kinds. It follows, unfortunately, that Microsense do not support or help owners of either the ITT 2020 or of directly-imported machines.

Owners, and on their behalf the Apple Systems User Group, must look for support from ITT in respect of the first kind of machine and from the importing dealer or direct from Apple in Cupertino for the second kind.

But what if the persistent rumours that ITT will pull out of Micro-computers should eventually turn out to be true? One could perhaps hope that in this situation, Microsense's (and Apple Inc's) war having been won, they would rally round and help the innocent victims of their commercial power-struggle.

And for users of directly-imported machines who haven't got a dealer or who can't get support from one? Well, if enough pressure were put on Apple Inc, then perhaps they would ask their U.K. distributor (Microsense, would you believe?) to sort out the mess for them.

In the last resort it looks to be down to Microsense who, after all, are effectively Apple-U.K. - and from our side of the fence that looks to be a pleasant and profitable position to be in. If in return they have to take on a little extra responsibility than the legal situation demands, so be it.

ANON

## Beginners Page

By John Sharp

There have been a number of beginners writing in requesting help with binary files, so this month let us begin with a look at what possible files you might have on a disk.

If you catalog a disk you will get something like this:-

```
A 002 HELLO
I 020 DRAGON MAZE
A * 004 PROGRAM 1
B * 002 FILE 1
T 003 TEXT FILE
R * 005 ANOTHER FILE
```

You may not get all these on one disk, and indeed you may not even have seen a T or R or even B on your disks. Leaving aside the first column of A,I,R,T,B for the moment, what does the rest mean. Well the \* tells you if a file is locked. If it is locked, you cannot write to the disk with the same program name. That is you cannot wipe out your program on the disk by overwriting it. The number is the number of sectors the program takes up on the disk. As a rough guide each sector is 0.25K. The name to the right is just that, the name of the file. I say file because it is that rather than a program. It is only when entered correctly into the Apple that it becomes a program, if it indeed is. A file with a T in the first column, is not a program. It might be a TEXT file to EXEC or it might be as the prefix suggests a TEXT file. A TEXT FILE is a bunch of data ready to be read into a program, e.g. a set of records, such as a set of names and addresses. If you want to see what is in a TEXT file then type:-

```
MON I,O,C <RETURN>
EXEC XXXXXXX <RETURN>
```

where XXXXXXX is the name of the TEXT FILE you want to look at. As each bit of data is printed, since you are doing the equivalent of typing in directly from the keyboard and pressing return, you will get SYNTAX ERROR, just as you would if you typed a command the APPLE does not

understand. You can slow down the screen printing by using CTRL-S. It tends to be a little noisy because of all the beeps and syntax errors, but can be a very useful tool. You could use the READ TEXT program on the master disk.

The A and I program file names are fairly straightforward. They correspond to APPLESOFT and INTEGER program files respectively. Unless you are only running disks that boot and take over the machine, you will be familiar with both of them.

The problem arises, however, with B (and R) files. B stands for BINARY FILES. R stands for RELOCATABLE FILES which are a special type of Binary file. You will see some on the DOS 3.3 TOOLKIT disk. They are produced from the APPLE ASSEMBLER on this same disk. So apart from a slight difference, they are basically the same type of file, a saving of a batch of machine code to disk. This can have various functions once it is in memory and this causes the problems for beginners.

The first type of file it can be is a program, written in machine code to make it run faster. A program example is a FID, MUFFIN or MASTER CREATE (on DOS 3.3 MASTER), and UPDATE 3.2.1 (on the DOS 3.2 MASTER). In order to get these to run as programs, simply BRUN FID or whatever the program name is.

Before going further, the number 034 or whatever is the number of sectors the file takes up on the disk. It only helps you (and the DOS) to keep track of how much of the disk you are using. This is dealt with in the DOS manual so I will not go into it here. For those members with tape only it will help to explain what these numbers mean in the software library lists. As a rough guide, four sectors equals 1K of program.

The next type of file is a Hi-Res Picture that has been saved. The length of memory taken by a Hi-Res Picture is 34 sectors; so if you see :-

```
B * 034 BASUG LOGO
```

on a disk catalog, you can be fairly confident that it is a picture. There may be other binary files coincidentally 34 sectors long which are not pictures, but the name usually tells you they are not. Alternatively, there are now ways of compressing pictures, so a picture can be less than 34 sectors. You then need a special program to put them back on the Hi-Res pages correctly. If you try to BRUN a Hi-Res picture, anything could happen. Normally you will just halt in Monitor. Try a few and see. You will not do the Apple any harm, just confuse it.

The third type of binary file is a set of data used in a program. It is a little bit like a text file except that it is totally machine code and wouldn't mean anything except to the program



that uses it. The best example is a shape table which is a set of points and directions. If looked at other than a shape table by the program you are using, it is totally meaningless. A good programmer will put some indication such as MARTIANS.OBJ or MARTIAN.SHAPE to let you know it is used in another program. The DOS 3.3 TOOLKIT fonts for example are labelled BYTE.SET, ROMAN.SET etc, to make this clear. It is as important as putting REM statements in if you wish to let others know what is going on. On some of the software library disks there are binary programs with just a single letter or a pair of letters; these are fairly obviously used by another program, and the author has made them too short to make you think to run them; the name just doesn't mean anything.

Another type of set of machine code might be data as for example in the copy program on the 3.3 Master disk. The copy programs look like this:-

```
* I 009 COPY
* B 003 COPY.OBJO
* A 009 COPYA
```

There are versions for you to use for copying disks if the BASIC you are using is INTEGER (the first one) or

APPLESOFT (the last one, which has an A tagged on the end since two programs cannot have the same name on the same disk otherwise there would be confusion when it came to running them.) In between is a machine code set of data for the other programs (both of them) to use. If you list these programs you will see a line that has a print"BLOOD COPY.OBJO"at line ... Why no D\$=CHR\$(4), well there is an invisible CTRL-D. You could see this if you used something like The APPPLE-SOFT PROGRAMMERS ASSISTANT on the DOS 3.3 TOOLKIT, or the PROGRAM LINE EDITOR.

The most confusing programs on the 3.3 Master it would seem are cataloged as:-

```
B * 050 FPBASIC
B * 050 INTBASIC
```

They are in fact APPLESOFT (or Floating Point BASIC) and INTEger BASIC, respectively. If you have a language or RAM card, then these files will be loaded onto the language card and the card locked so that it appears to be an INTEGER CARD or APPLESOFT ROM CARD. If you have an APPLE II PLUS, look at the HELLO program, by just loading it. LINE 210

has "BLOAD INTBASIC.A\$D000". Again there is an invisible CTRL-D. The A\$D000 means load it at position D000 in memory, which is on the language card.

When a binary file is saved, it is necessary to tell DOS the start and ending locations of the program. This information is saved onto the disk. When you load the program back, it will be loaded into the same position, unless you tell it otherwise. The A\$D000 in this BLOAD statement tells it not to load it where it was saved from. This is in fact in the middle of memory and it will load there if you just BLOAD INTBASIC. If you try to BRUN INTBASIC, then since it is not written to run in this location, but on the language card, it will cause you to think your machine has developed a fault.

If there are any more problems, please write in and we will see what help we can give.

John Sharp

It is interesting to see the piece about Microsense (the forerunner of Apple UK) in the light of the present lack of interest in the Apple II series from Apple worldwide. Many people in fact are still using DOS 3.3.

## Enthusiasts!

**Open-Apple** is Tom Weishaar's monthly newsletter for knowledgeable Apple II users. It's thin but packed tight with Apple II lore, humor, letters, tips, advice, and solutions to your problems. Compared to other Apple II publications, **Open-Apple** has the highest new-idea-per-issue ratio, the clearest writing, the funniest cartoons, the longest index, the best warranty (all your money back if you're not satisfied), and it takes up the least shelf space.

### II cue #6

You can add a IIc-like second 64K bank of memory to an Apple II-Plus by plugging in an accelerator card. Neither 80-columns nor double-high-res are added, since that circuitry doesn't exist on the II-Plus. Most programs don't realize the memory is there. But programs that check for the memory, or that can be fooled into thinking the machine is a IIc, can access it. For more information, see "RAM found in accelerators" in the December 1985 **Open-Apple**, page 2.88.



### From our fan mail:

Despite its small size, **Open-Apple** is the best Apple Information source I've ever found. Creating a forum for the global Apple II user community is a noble purpose.

Jerry Kindall, Grove City, Ohio

Let me add my appreciation to the chorus of Apple II users who have come to depend on **Open-Apple** for the most accurate, realistic, and down-to-earth information available.

Nevin Diener, Keezletown, Va.

**Open-Apple**

POB 7651, Overland Park, KS 66207

### Try two months free!

Offer good one time only. Try **Open-Apple** at our expense. Cut out or photocopy this coupon and mail it to us for a free two-month trial subscription.

Ad code: M282

\_\_\_\_\_

\_\_\_\_\_

\_\_\_\_\_

\_\_\_\_\_

Free airmail worldwide.

Apple II  
II GS  
Macintosh



WAR GAMES, ADVENTURE GAMES  
SIMULATORS & SPORTS

Strategic Plus Software  
Dept. A2  
PO Box 8, Hampton, Middx TW12 3XA  
Telephone 01 979 2987

STRATEGIC  
PLUS  
SOFTWARE



Send £2.50 for Extensive Catalogue.



# DB Master

## Terry Cymbalsty reviews this sophisticated database

### Hardware Requirements

Enhanced //e with extended 80 column card or //c or //GS or Laser 128.

2 off 5 1/4" disk drives or 1 off 3 1/2" disk drive or 1 any floppy disk drive plus ProDOS compatible hard disk.

A RAM disk is highly desirable, as is Backup and Restore from Glen Breddon's Prosel.

### Review System

128k enhanced //e 1Mb Cirtech PlusRam RAM card in slot 5 3 1/2" 800k Unidisk in slot 7 Grappler + printer interface card in slot 1 Epson FX80 clone printer. Glanmire Time-Kit clock board in 16 pin games socket DB Master Version 5 Pre-Release #5

### Introduction

I would like to assume that most readers are familiar with Appleworks and as such I would like to use the database module within Appleworks as the program to compare DB Master (hence forward referred to as DBM) against. DBM goes a lot further than Appleworks being a far more sophisticated product. This is not to be seen as detracting from Appleworks as I feel that the two programmes are aimed at different audiences.

### The Package

DBM consists of the following: 1 off 3 1/2" floppy 4 off 5 1/4" floppies 1 off reference/tutorial manual The manual supplied is a 9" x 8" 3 ring binder 500 page affair. Note also that one either uses the 3 1/2" disk or the 5 1/4" disks depending on what types of drives the owner possesses. The first part of the manual is a fairly good tutorial. This leads the owner through the various stages involved in creating an estate agent's database and also using an existing database provided on the floppy disks. Also reports are dealt with quite extensively within the tutorial as reports are one of the strong points of DBM. DBM is ProDOS based and the supplied disks are unprotected.

### Bad Points

The package is very sophisticated and as such is not as immediate as

Appleworks. Appleworks is easy enough to learn without referring to the manual (I lost mine a long time ago!). DBM on the other hand really benefits from a good understanding of its features. In fact the tutorial only glosses over some of its features and its more advanced features must be learnt from the good reference section of the manual. DBM constantly refers back to the program disk. Using a 3 1/2" disk eliminated constant disk swapping if I were to have used DBM on 5 1/4" disks. Also 3 1/2" disks are a lot quicker than 5 1/4" disks. But DBM gets over this problem because when the program is first booted, if it finds a ram-disk it prompts the user if he wants to have DBM loaded into it. It quite happily recognised my



PlusRam card and then proceeded to copy itself into it. This process, although only a one-time operation, was quite slow because it copied itself file by file. I then used the ProSel Restore program which did the task far quicker. Of course if one was using the ram-disk to store data then the Prosel Backup program would be used. DBM always seems to write back to the database on disk when ever a modification is made. This slowed things down a lot. This is why I stored my data on the ram-disk (as mentioned in the last point). Having done this, DBM flew along with no problems what so ever (and when my

Zipchip finally arrives...). I found, at least what I thought, was as serious bug or at least a drawback. From the main menu it is possible to perform some ProDOS commands, one of which is rename. I was not happy with a name I had given one of the databases I had created. I tried to use the aforementioned rename command and DBM told me that it was not possible to rename a database. Not to be put off, I then tried Copy|+ , which worked quite nicely. When I next tried to access the renamed database file using DBM, I got the reply that the data was no longer recognised! My database was now corrupt. It was quite lucky that the database did not contain too much data. The method of going back a level in the menu system was not consistent and meant that one constantly had to refer to the on-screen menu. In some places the escape key was required, in other cases control Q was required. There were other key combinations in other situations as well. There is on-line help available. On expecting to see some useful sentences on screen when this function was called up, in fact all I got was a page number referring to the relevant section of the manual! DBM comes with one of those silly license agreements which state:

*"Stone Edge makes no warranties..... Stone Edge licenses this software on an "AS IS" basis..... The entire risk as to the quality and performance and its appropriateness for your needs is with you....."*

In otherwords, what in the hell are you getting and does the manufacturer have any faith in the product? DBM is not as disk space efficient as Appleworks. An Appleworks database occupied 53 kbytes on disk but when it had been converted into DBM format, it occupied 106 kbytes. In otherwords twice as much space. Perhaps not a drawback for those with hard-disks or 3 1/2" drives, but may cause some problems for those with only dual 5 1/4" drives.

### Good Points

DBM is very strong on field types. Note also that the date format is quite flexible too. There are nineteen different formats! DBM's handling of formulas for computed fields is quite impressive too. For instance such functions as:

+, -, \*, /  
=, <, >, <=, <=,  
parentheses  
constants  
AND and OR  
NOT()  
INT()  
ABS()  
SGN()  
exponents

Note also that the above are usable in the database and not only in reports as in Appleworks. Multi-line comments are allowed in DBM data-



bases. This is a great drawback in Appleworks as far as I am concerned. DBM can read into its own database Appleworks databases. What one does is to create a DBM database making quite sure that the field names are EXACTLY the same as those used in the Appleworks database (note that it is case insensitive). This is obviously a good feature if one is upgrading from Appleworks. The manual is very good (far better than the Appleworks manual). The glossary contains all the functions sorted alphabetically. The function is described in a clear non-technical manner making the program easy to learn, considering the complexity.

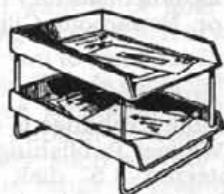

Primary/Secondary fields are used to index the records enabling them to be quickly found during sort operations. If records have common Primary fields then Secondary fields may be specified. It is important that all records have unique Primary or Primary/Secondary fields. In actual fact, this point was brought home when I tried to convert my Appleworks database for my music LP collection I had problems at first. Initially I used the "Artist Name" field as the Primary field without using a Secondary field. On conversion problems were encountered. When I specified the "LP Title" field as a secondary field, the database converted quite nicely.

#### Summary

All in all, probably the best database product available for the Apple // range of computers.

TO Cymbalstly



info

Product : DB Master 5

Publisher : Stone Edge

Available from :

MGA Softcat

Pear Tree

Appledore Kent TN26 2AR

(0233) 83571

Price : £177.00

£293.00 Professional

£193.00 DB 4+ for ][+

Value :           ★★★★

Performance :   ★★★★★

Documentation :  ★★★★

#### DBM has a very good specification:

Capacities:

Upto 2000 bytes per record

Upto 200 fields per record

Upto 30 screen pages per record

Upto 250 characters in alphabetic fields

Upto 50 bytes in primary key (any number of fields)

Hard disk files (up to 10Megabytes)

Floppy disk files, upto 50 disks (5 1/4", 3 1/2" or mixed)

Data stored on disk is compacted to save disk space.

#### Field Types:

Alphanumeric, 1 to 250 characters

Numeric - integers, 0-255 (1 byte)

Numeric - integers, +/-32,767 (2 bytes)

Numeric - floating point, 1-16 digits (8 bytes)

Dollar/cents, to \$99,999,999.999.99 (8 bytes)

Yes/No - 1 character, only accepts "Y" or "N"

Date - 11 formats available

**Formats available:** MM-DD-YY, DD-MM-YY, YY-MM-DD,

MM-DD-YYYY, DD-MM-YYYY, YYYY-MM-DD, DD-MON-YYYY,

DD-MON-YY, MON-DD-YYYY, YY-MON-DD, YYYY-MON-DD

Add Date - date when record was added to file

Edit Date - last date when record was edited

Add Time - time when record was added to file

Edit Time - time when record was last edited

NOTE: Time fields require a ProDOS compatible clock - my

Ganmire Time-Kit worked fine, as expected

User Defined - for phone & social security numbers, part

numbers, etc., 2-20 characters, control over type of

characters allowed in each position

Label Only - no input area, useful for customizing screens

#### Computed Fields:

Floating point numeric, dollar/cents and date fields can be

computed fields. Each formula can be upto 75 characters long.

Functions include AND, OR, INT(), SGN(), NOT() and ABS().

Examples: F10 = F7 + F8 + F9 + .06 \* F12

F28 = F10 \* (F50 >= F10) + F50 \* (F50 < F10)

F5 = (F10 > 100 AND F20 < 1000) OR (F27 > F26)

Where the F stands for Field

#### Report Generator:

Report width : 40-255 characters

Upto to 255 lines per record on upto 3 pages

Upto 255 fields per report

Print labels upto 5 across

Header and footer lines: each report can have separate lines of

text (including normal and computed fields) that print at the

beginning/end of the entire report, of each page, of each group of

records, and of each column Column subtotals and totals, page

numbers, record numbering, and date or time the report is

printed can be treated as fields and printed anywhere on the page

or within header and/or footer lines

Set justification, printstyles, case conversion, number formatting,

statistics, date formats, etc. on a field-by-field basis

Statistics include: count, total, average, min., max. & standard

deviation

Complex computed field formulas including calculations based on

column totals and subtotals

Sort on upto 9 fields at a time; choose ascending/descending and

case sensitive/insensitive for each sort field

Print to printer, disk (text file) or screen

A wide range of printers are supported by way of Printer Drivers.

These include:

Apple Imagewriter

Apple Imagewriter 2

Apple Scribe

Epson MX-80 compatibles

Epson FX-80 compatibles

IBM compatibles

Okidata 82, 83, 182 etc

Okidata 92, 93, 193 etc

Diablo daisy-wheel printers

NEC daisy-wheel printers

QUME daisy-wheel printers

Generic printers

# The Graphic Exchange & Print Magic

## Peter Stark reviews these two powerful Graphics Utilities

### INTRODUCTION

The Graphic Exchange is a utility for the Apple IIGS (at least 512K of RAM being needed). It allows many types of Apple II or Macintosh graphic to be converted into Apple II graphics of different formats. Its capabilities make it a versatile program, with a great number of possible uses. Just for example: starting with a Super Hi-Res (SHR) picture from (say) Paintworks, you can use The Graphic Exchange to produce a Double Hi-Res (DHR) version of it for use with Publish-It! Also, Print Shop graphics can be converted into SHR or DHR format, for further processing. Very attractive, too, is the fact that The Graphic Exchange lets you convert MacPaint graphics into SHR or Print Shop graphics, and so on. There is plenty of scope for using your imagination in other ways, as I hope you will see from the description given below.

### SCOPE

The graphic formats which can be used with The Graphic Exchange are:

- Lo-Res
- Double Lo-Res
- Hi-Res (color, and black and white)
- Double Hi-Res (color, and black and white)
- 320 Super Hi-Res (color)
- 640 Super Hi-Res (color, and black and white)
- Print Shop [DOS] (black and white)
- Print Shop GS (color)
- Newsroom Clip Art (black and white)
- Newsroom Photos (black and white)
- MacPaint (black and white).

Graphics in any of these formats can be converted into graphics in any of the other formats. Also, if you wish, a graphic can be converted into a different one (e.g. of some other size) in the same format. By the way: if you want to be able to convert MacPaint graphics, you will need a IIGS with at least 768K of RAM.

The Graphic Exchange allows you to carry out three different types of graphic transfer (i.e. conversion). The first and simplest of these is 'Standard Transfer', which is used for pixel-to-pixel conversion from the

source into the destination screen. Depending on whether the destination screen is of higher or lower resolution than the source screen, the converted image will be narrower or wider than the original one.

The second type of transfer is 'Scaled Transfer', and this is a very powerful and valuable feature. First, you select whatever area you wish to transfer from the source screen, and then you can set the transfer area on the destination screen to whatever size you choose. Thus, you are able to enlarge or shrink a given area of a graphic, and you can also make it narrower, wider, taller, or shorter if you want to. Of course, if you choose the source and the destination screens to be the same, you can also use the 'Scaled Transfer' mode for editing a single graphic in various ways without changing its format.

The third type of transfer, 'Full Screen Transfer', is also very useful. This function converts an entire screen from one graphic mode to an entire screen in a different mode.

Another helpful feature is the 'Set Background Color' option. This lets you designate a specific color as one which is NOT to be transferred from the source screen to the destination screen. To take the example given in the manual supplied with The Graphic Exchange: suppose that you had a picture of a brown dog on a white background, and that you wanted to transfer the image of the dog to another screen that had (say) a grey background. In such a case, you could set the background to "white". The result would be that only the image of the dog would be copied to the destination screen, whereas the (unwanted) white background of the source image would not be transferred across and cause problems.

Yet another useful feature is 'Exchange Black and White': this changes any black portions of a chosen area of a screen picture into white, and white into black. With a color screen, only the black and white areas are reversed: the rest remain unaffected. Also helpful is the 'Undo Last Change' option, which allows you to have second thoughts when something that you tried did not turn

out well.

Other menu options let you catalog directories or load graphics of specified types from disk. You can display a particular graphic on the screen if you want to, save graphics to disk, and so on.

Also helpful is the 'Slide Show' option. If you choose this, all of the graphics of a specified type from a selected directory are shown briefly on screen, each in succession. If you decide to stop this sequence before the end, just click the mouse.

Although The Graphic Exchange does not enable you to format disks, it does have a 'Create Data Disk' facility which causes previously formatted 5.25" disks to be customized so as to be usable as data disks for Print Shop graphics or Newsroom Clip Art or Photos.

### WHAT IS SUPPLIED

The Graphic Exchange is supplied by Roger Wagner Publishing, Inc. as an unprotected 3.5" disk together with a 34 page paperback manual. The disk contains the three essential program files, together with a number of sample pictures in various graphic formats for you to practise with.

The manual is easy and clear to read. It includes a useful tutorial, plus fairly detailed descriptions of all the menu options that The Graphic Exchange offers. Information is also given about the graphic modes which The Graphic Exchange supports. The manual is slightly marred by a few minor editorial imperfections, but none of these is serious.



### OVERALL COMMENTS

I am enthusiastic about The Graphic Exchange, and have used it quite a lot. It is powerful and versatile, and does its job smoothly and well. There are just a few minor ways in which future versions of this already excellent utility might possibly be improved still further. For example, when you are about to save a converted graphic to disk, it would be useful to be told how much free space is left on the disk. Also, it might be helpful to have some positive warning that you were about to use a file name which was the same as one already in the same directory. When working with color pictures, the colors in the generated graphic can sometimes be the wrong ones (however, this is usually fairly easy to put right, for



example by using a suitable paint program). To keep things in perspective, however, I should emphasize that these are just rather minor points, which do not detract from the usefulness of The Graphic Exchange.

Overall, I enthusiastically recommend The Graphic Exchange as an excellent and versatile piece of software. I found it easy to use (particularly with the aid of a mouse), and it didn't take me long to get to grips with it. The menus in The Graphic Exchange are clear and helpful. Although some of the graphics transfers take a few seconds, the speed of operation is usually impressive, and you never have to wait unreasonably long for the results. If you have an Apple IIGS and want to be able to handle and change graphics, it is well worthwhile for you to consider The Graphic Exchange. This is especially the case if you use programs such as Print Shop or Publish-It!, since a conversion utility such as this makes an enormous range of graphics potentially available to you.

**Peter Stark**

□ Footnote: This is a modified version of a review which appeared recently in The Gateway Gazette (published by the Gateway Computer Club, Mildenhall, Suffolk).

## Print Magic

If you enjoy using Print Shop, and are primarily interested in printing in black and white rather than colour, you will almost certainly be delighted with Print Magic, a recent product from Epyx, Inc. Like Print Shop, Print Magic can be used to prepare one-page documents, greeting cards, or paper banners. However, as described below, Print Magic is particularly attractive because of its impressive versatility, its ease of use, and the quality of its printed output.

Print Magic is supplied as two double-sided disks (DOS 3.3; not copy protected). One of these is the Program Disk, and the other contains graphics and a range of typefaces. Also supplied are a well written 40 page manual and a card showing the available typefaces and graphics. To run Print Magic, you need an Apple IIc, IIe (with 128 K), or IIGS. Several different printers and interfaces can be used. Operation can be either via the keyboard or (preferably) by use of a mouse.

Print Magic is menu-driven and extremely simple to use. After a little practice, I found that I hardly ever needed to refer to the manual again. Despite this simplicity, the program is remarkably powerful, and it gives you a great deal of scope to use your imagination in designing and finalising the layout of documents. In this respect, Print Magic offers some really significant advantages over Print

Shop (and even over Print Shop GS in certain respects). Just for example: when entering text, you can use several different typefaces (fonts) on the same page if you wish, and these can be in various formats (Plain, Bold, Underline, Italic, and/or Overlay). (However, there are no 'Outline' or '3D' options). A Typeface Editor is also provided. To widen the range of 'fonts' that can be used, Fontrix fonts can also be loaded and used with Print Magic. Each typeface can be printed in two sizes, and in both lower and upper case. Another very attractive feature is that you can position your text wherever you wish on the page, and you can move it about until you are satisfied. The various fonts supplied as standard with Print Magic range in height from quite small (about 2.5 mm) to nearly 1 cm (when printed out using the smaller of the two alternative size choices).

As regards graphics: here too there are many exciting possibilities and alternatives. You can use: (1) the graphics which are supplied with Print Magic; (2) Print Shop graphics; (3) Newsroom Clip Art; and/or (4) HiRes picture files produced using other drawing programs. In this last case, the whole screen image can be used if you wish, or just a chosen part of it. The graphics can be viewed on the screen before you decide exactly where to position them, and you can place the individual graphics wherever you want. Since the graphics can be printed in various sizes (provided that they fit completely on the page), and since several different graphics can be put on any one page, the number of variations is infinite.

Also very useful is the fact that Print Magic allows you to create rectangular borders and to place them anywhere on the page. These can be of almost any size (this means that you are not limited to having only one border, around the edges of the page). With Print Magic, 24 different patterns are provided for the borders, and each can be in any one of 9 widths. Thus, if you so wished, you could have several separate borders on your page, in different positions, and each having its own individual size, pattern, and width. The only significant restriction seems to be that you are limited to the two dozen patterns provided.

Print Magic offers Paint and Draw facilities which enable you to draw freehand or to draw various shapes. In each case, you have a choice of 'pen' widths and patterns (and 'fill' patterns).

With Print Magic, there is a 'View' facility which permits you to look at chosen areas of the page in fine detail. Moreover, the 'Zoom' sub-menu allows you to magnify and display a small portion of the page and to make pixel-by-pixel changes. There is also an extremely useful 'Modify' option which enables you to change selected

parts of the page (that is, to flip it horizontally or vertically, or to invert all the pixels, or to clear a specified area).

The quality of the printed products is usually good. Text and graphics both come out well (and the graphics supplied with Print Magic often look especially pleasing). The only cautionary remark which I need to make is that it is best to use a reasonably new printer ribbon. Heavily worn ribbons give rather faint printed results! Also, you need to bear in mind that (a) you are only able to print in black and white, and (b) like Print Shop, Print Magic only produces one-page documents.

Overall, I am very enthusiastic about Print Magic, which combines the virtues of versatility and easy operation. It is a splendid alternative (or complement) to Print Shop, and I warmly recommend it.

**Peter Stark**

□ Footnote: This is a modified version of a review which appeared recently in The Gateway Gazette (published by the Gateway Computer Club, Mildenhall, Suffolk).

info

*Product* : Graphic Exchange

*Publisher* : Roger Wagner

*Available from* :

MGA Softcat

Pear Tree

Appledore

Kent TN26 2AR

(0233) 83571

*Price* : £39.95

*Value* : ★★★★★

*Performance* : ★★★★★

*Documentation* : ★★★★★

info

*Product* : Print Magic

*Publisher* : Epyx

*Available from* :

MGA Softcat

Pear Tree

Appledore

Kent TN26 2AR

(0233) 83571

*Price* : £24.99

*Value* : ★★★★★

*Performance* : ★★★★★

*Documentation* : ★★★★★

# A tale of Eve and that Watchmaker - Deepspace

## Mike Tickle programs in Logo and Robert Hornby rockets into space

I wrote EVE after reading The Blind Watchmaker by Richard Dawkins to prove to myself that it made sense. I used Terrapin logo on an Apple IIe. To run Eve type REP followed by a pair of positive numbers, eg. REP 65 87 RTN. EVE will draw 6 biomorphs on the top of mixed screen with the numbers individually responsible along the bottom. In Terrapin logo you can switch between full, text and mixed screens in real time. The top left biomorph is the one which results from your numbers. The remaining 5 are random mutations. You act as the constraint on reproduction by choosing which of the 6 shall survive to reproduce by calling REP again and entering the appropriate pair of numbers. Each biomorph has 6 'chromosomes' two of which are variable and subject to mutation by the RANDomise routine. The other four are imbedded in the program. It is surprising how much variation these routines generate. Perhaps some enterprising creator can add some routines to save and read the two numbers and store the biomorphs in a coherent fashion. A description and listing of EVE follows:-

### REP

REPRoduce the family of 5 offspring. REP is the main routine and takes your 2 inputs which are randomly altered to provide 5 offspring basically the same, but altered enough to speed up evolution to a rate which is obvious.

### GROW

GROW contain 3 imbedded chromosomes. size, age, growth modifier

### DEV

DEVELOpe draws the biomorph and is the type of routine which draws simple fractals, as a further confusion it is also recursive.

### RAND

RANDom contains the 6th chromosome and provides the variability.

### MOVE. MESS

MOVE and MESSAGE move the cursor about and print on screen the two mutated chromosomes corre-

sponding to biomorphs being drawn.

### LOGO LISTING

```

TO REP :LV :RV
  HOME CS
  MAKE "H 0
  MAKE "X 0
  MAKE "Y 0
  MAKE "X1 90
  MAKE "Y1 60
  PRINT "
  MOVE :H ( :X - :X1 ) ( :Y + :Y1 )
  MESS 22 1 :LV :RV
  HT
  GROW :LV :RV

  MOVE :H :X :Y1
  MAKE "LV :LV + RAND
  MAKE "RV :RV + RAND
  MESS 22 13 :LV :RV
  GROW :LV :RV

  MOVE :H :X1 :Y1
  MAKE "LV :LV + RAND
  MAKE "RV :RV + RAND
  MESS 22 26 :LV :RV
  GROW :LV :RV

  MOVE :H :X ( :Y - :Y1 )
  MAKE "LV "LV + RAND
  MAKE "RV "RV + RAND
  MESS 23 13 :LV :RV
  GROW :LV :RV

  MOVE :H ( :X - :X1 ) ( :Y - :Y1 )
  MAKE "LV :LV + RAND
  MAKE "RV :RV + RAND
  MESS 23 26 :LV :RV
  GROW :LV :RV
  PRINT "
END

TO GROW :LV :RV
  DEV 6 13 :LV :RV .8
END

TO MOVE :H1 :X2 :X3
  PU
  SETH :H1 SETXY :X2 :X3 PD
END

```

```

TO DEV :SIZE :AGE :LV :RV :MODIF
  IF :SIZE > :AGE THEN STOP
  LT :LV
  FD :SIZE
  DEV :SIZE / :MODIF :AGE :LV :RV
:MODIF
  BK :SIZE
  RT :RV
  FD :SIZE
  DEV :SIZE / :MODIF :AGE :LV :RV
:MODIF
  BK :SIZE
  LT :LV
END

```

```

TO RAND
  RANDOMIZE
  MAKE "N RANDOM 11
  IF :N < 6 THEN OUPUT ( :N - (
:N + 2 )
)
  OUTPUT :N - 5
END

```

```

TO MESS :HT :VT :LV :RV
  CURSOR :VT :HT
  ( PRINT1 :LV " ` ` :RV )
END

```

Mike Tickle



## Deepspace

I thought that Deepspace was a game which brought space docking, fighting and securing ships to base.

There are five different aspects of the game, one, you should be able to fly the ship, two, you should handle landing well, three, able to understand the information given to you, four, know how to use your coordinates for the lasers and finally have the right computers to play it which are the Apple II Series.

The game was a simulation which had four different sort of games, escort, outpost mission, invasion mission and plague mission. All the levels were in 3D and colour. The graphics I found were okay but could have been better. The game itself got boring after a few games but it got exciting when attacked. Loading it was simple and does not take long.

The documentation was great, it was laid out like a proper mission with mission background which had newspaper clippings and the mission. Also it comes in a folder.

Robert Hornby (Aged 11)

Deepspace: £29.95 from MGA, Peartree, Appledore, Kent TN26 2AR



# Connect your Macintosh to the Hewlett-Packard Range of Printers

and H.P. Compatibles

For the "DeskJet and DeskJet Plus"  
Use the purpose made Software Driver  
'PRINTER INTERFACE III' £150-00  
giving you Low cost Laser quality  
output for ££££'s Less.

H.P.LaserJet Series & compatibles  
'PRINTER INTERFACE IV' £150-00  
Mix Laser Quality text & graphics  
for True Laser output

## 'GIANT FONTS'

We can supply 19 fonts in a single package 3 x 800k Disks (42- 108 point sizes) £75-00  
Giving you 4 Times the size Fonts to work with.

*New Daisywheel &  
Driver for Letter Quality  
£250-00*

## Special PRINTER OFFERS

*True Appletalk,  
PostScript Laser Printers  
for £2600-00*

*DeskJet £485-00*

All prices plus post & packing plus VAT.

*DeskJet Plus £575-00*

*H.P. Compatible Laser Printer with future Up-grade facility to PostScript £995-00  
also*

*H.P.PaintJet in 256 glorious colour output with a Mac Driver. Ring for Price*

**Birmingham Showroom Opening in early June**  
**Everything for the 'Mac' Demo's & discount too.**

● Laser Toner Recharge  
from £35-00 inc.pp+vat

● Produce your own OHP colour  
with the H.P. PaintJet

● In-House DTP- Laser Print Facility

High Quality Computer accessories always available. Call in for a coffee and a chat.

Supreme Mac Software Ltd  
Units 25 - 29 Saltley Mill,  
Adderley Road Industrial Estate  
Birmingham  
ENGLAND



PHONE 021 327 0666 / 327 0808 FAX 021 327 0110



# The Rocket Chip

## Dave Ward supercharges his Apple yet again - Where will it all end I ask?

Make ready to take off!! RocketChip has arrived! Approximately a year ago the Apple // press was awash with news of Apple // accelerators on a chip. Zip Chip, much belated, we reviewed in Apple 2000 magazine and now RocketChip has arrived as its competitor. MGA Microsystems have kindly loaned us a RocketChip for this review.

Let's see what the manufacturers say about the RocketChip (See the box below)

The RocketChip arrives in a small box padded with styro-foam together with a floppy 5.25" diskette of utilities and a 12 page preliminary manual. Most of the manual deals with the installation of the RocketChip in Apple II plus, Apple //e and Apple //c machines. The RocketChip measures just 55mm by 21mm by 9mm and is simply fitted by removing the 6502/65C02 chip from your Apple // computer and replacing it with the RocketChip. The descriptions in the manual are quite comprehensive except for the European Apple //e where the 6502/65C02 is in a different place than the diagram for the US of A machine. I found the RocketChip

quite difficult to fit as the pins are not in their correct positions and have to be slightly bent. Even with a strong light it is very difficult to see the pins when installing the RocketChip due to the large overhang of the chip. Great care is needed to prevent bending of the pins. I think that the manufacturers could improve matters here. Unlike most users I tried the RocketChip in almost 20 Apple // computers and the second and subsequent installations proceeded easily since the pins were correctly aligned. The first installation took some 15 minutes compared with 1 or 2 thereafter!

On switching the machine on the following are the RocketChip defaults:

5MHz 65C02  
Slots 5 and 6 have 1MHz access whilst the others have 5MHz access.  
2.2 second pause on boot-up.

### Changing defaults from the keyboard

These defaults are generally satisfactory for most users and the most important ones can be changed from the keyboard whilst others can be

changed using the utilities diskette. First let's look at the keyboard adjustments. The RocketChip can run at two speeds 'fast' (5MHz) and normal Speed (1MHz). Pressing the ESCape key whilst booting sets normal speed until you switch off or change it. Pressing the return key whilst booting sets 'fast' speed. You can even remove the 2.2 second wait on booting by pressing control-D whilst booting and - believe it or not - restore it with control-F!!

### Transwarp protocol method of changing speed

From Applesoft :

```
POKE 49268,0 = 'fast' speed.  
POKE 49268,1 = normal.
```

From machine code :

```
LDA #$00  
STA $C074 = 'fast' speed.  
  
LDA #$01  
STA $C074 = normal speed.
```

\*\* 'fast' can be any one of the 5MHz, 4MHz, 3MHz, 2MHz, 1MHz, 500KHz, 250KHz, 100KHz, 50KHz that the RocketChip can be set to.

### Using the utilities diskette

This 5.25" floppy diskette is ProDOS formatted on the main side and DOS3.3 on the other side. To make the changes you want you just BRUN the file name you require; these are reasonably well described in the manual. The manual only refers to these files and gives no information as to how the RocketChip can be programmed. This makes changing defaults easy for non-programmers and programmers can soon copy the code in the files to insert in their own programs. Figure 1 on the next page is a directory listing, produced with Information Desk from ProSel, of the files on the ProDOS side of the diskette.

### 1) AppleWorks

AppleWorks is perhaps the most widely used package on the Apple // range of computers so a variety of timings for the most popular systems have been tried as follows :-

#### Spreadsheet 139K and 850 rows

The following table shows the time taken to do a re-calculation on the whole file.

Sys	RocketChip	Normal	% increase
1	11.0s	43.0s	390
2	13.0s	46.5s	358
4	12.5s	45.0s	360

#### Spreadsheet 285K and 900 rows

Sys	RocketChip	Normal	% increase
1	28.0s	108.0s	385

Bits & Pieces Technology is pleased to introduce you to RocketChip - the most advanced single-chip accelerator available for the Apple II, II Plus, IIe and IIc computer marketplace. It does not require cables, slots or a complicated installation procedure. RocketChip does speed up program execution from all memory locations (64k or 128k), 1.6 Megabytes of auxiliary memory, expansion ROMs and the peripheral board ROMs, while retaining normal game paddle/joystick operation and offering you the choice of normal or unique game play sounds.

### RocketChip Features

- Operates from 5MHz to 50KHz - 5 times faster than normal Apple speed to 20 times slower than normal Apple speed of 1MHz.
- Requires very little power - Less than 100mA.
- Easy to install and does not require a slot.
- Standard power-up configuration or can be programmed by the user.
- Keyboard selectable special features.
- Emulation of AE Transwarp speed setting protocol.
- Accelerates all memory locations:
  - \*System memory (64k or 128k)
  - \*Auxiliary memory up to 1.6 Megabytes.
  - \*Expansion ROMs.
  - \*Peripheral card ROMs.
- Accelerates all 80 column operations.
- Non-standard configurations of the RocketChip registers are retained until the power is turned off.



Wordprocessor 66K 1654 lines with 37646 words

The following table shows the time taken to change all of the 550 occurrences of THE with ZXC.

Sys RocketChip Normal % increase

1	49.5s	201.0s	406
2	51.0s	197.0s	386
4	41.5s	169.5s	408

Key to the systems :-

1) Apple //c with 576K Multi-RAM on board.

2) Apple //e with 256K Ram-Works on board.

4) Apple //e with 1Meg Cirtech plusRAM on board.

The numbering system is retained from the Zip Chip review to make any comparisons easier.

The above show a very good increase in speed considering that the maximum for the RocketChip is 500% and the AppleWorks program and data extend over a large amount of memory. Speed will vary a little depending upon the size of file and the operation you are doing. Note that if you use a large memory card such as the Cirtech plusRAM, Apple memory card or RamFactor make sure that the RocketChip is set to fast access to the slot in which you place the memory card

## 2) Merlin 8 assembler

Merlin Version Processor Time to assemble

MERLIN 8	Apple //c and Apple //e Rocket Chip	3.8 = 13,700 lines/min
MERLIN 8	Apple IIgs fast	5.6 = 9,000 lines/min
MERLIN 8	Apple IIgs slow	13.0 = 4,000 lines/min
MERLIN 16	Apple IIgs fast	4.2 = 12,000 lines/min

The effect of the RocketChip in the Apple //e and Apple //c is to give an overall 342% increase in speed, for Merlin 8 users. Merlin 8 is a very fast assembler anyway but is somewhat faster than Merlin 16 on an Apple IIgs when Rocket Chip is installed.

## 3) Two machine code programs - one small the other large.

Glen Bredon's Apple Pie program to calculate Pi to 1000 decimal places gives a good guide to the effect of the Rocket Chip on small machine code programs :-

Standard Apple //	= 194.6 seconds
with the Rocket Chip	= 45.0 seconds
	432% increase
Apple IIgs fast	= 78.2 seconds
	249% increase

Colossus 4 was used to solve a four move chess problem by Dr. A Mandler

Figure 1

Directory: /ROCKETCHIP/ Page 1 30-Apr-89 7:21:49 PM

Filename	Blocks	Type	Modified	Created	Length	Subtype
PRODOS	32	SYS	14-Apr-88	23-Nov-88	\$3C7D	\$0000
BASIC.SYSTEM	21	SYS	10-Sep-84	23-Nov-88	\$2800	\$2000
SLOT.SPEEDS	2	DIR	23-Nov-88	23-Nov-88	\$400	\$2000
..APPLE.SLOT7	1	BIN	23-Nov-88	23-Nov-88	\$40	A=\$0300
..APPLE.SLOT6	1	BIN	23-Nov-88	23-Nov-88	\$40	A=\$0300
..APPLE.SLOT5	1	BIN	23-Nov-88	23-Nov-88	\$40	A=\$0300
..APPLE.SLOT4	1	BIN	23-Nov-88	23-Nov-88	\$40	A=\$0300
..APPLE.SLOT3	1	BIN	23-Nov-88	23-Nov-88	\$40	A=\$0300
..APPLE.SLOT2	1	BIN	23-Nov-88	23-Nov-88	\$40	A=\$0300
..APPLE.SLOT1	1	BIN	23-Nov-88	23-Nov-88	\$40	A=\$0300
..ROCKET.SLOT7	1	BIN	23-Nov-88	23-Nov-88	\$40	A=\$0300
..ROCKET.SLOT6	1	BIN	23-Nov-88	23-Nov-88	\$40	A=\$0300
..ROCKET.SLOT5	1	BIN	23-Nov-88	23-Nov-88	\$40	A=\$0300
..ROCKET.SLOT4	1	BIN	23-Nov-88	23-Nov-88	\$40	A=\$0300
..ROCKET.SLOT3	1	BIN	23-Nov-88	23-Nov-88	\$40	A=\$0300
..ROCKET.SLOT2	1	BIN	23-Nov-88	23-Nov-88	\$40	A=\$0300
..ROCKET.SLOT1	1	BIN	23-Nov-88	23-Nov-88	\$40	A=\$0300
STARTUP	1	BAS	23-Nov-88	23-Nov-88	SE8	\$0801
SPEED.5MHZ	1	BIN	23-Nov-88	23-Nov-88	\$40	A=\$0300
SPEED.4MHZ	1	BIN	23-Nov-88	23-Nov-88	\$40	A=\$0300
SPEED.3MHZ	1	BIN	23-Nov-88	23-Nov-88	\$40	A=\$0300
SPEED.2MHZ	1	BIN	23-Nov-88	23-Nov-88	\$40	A=\$0300
SPEED.1MHZ	1	BIN	23-Nov-88	23-Nov-88	\$40	A=\$0300
SPEED.500KHZ	1	BIN	23-Nov-88	23-Nov-88	\$40	A=\$0300
SPEED.250KHZ	1	BIN	23-Nov-88	23-Nov-88	\$40	A=\$0300
SPEED.100KHZ	1	BIN	23-Nov-88	23-Nov-88	\$40	A=\$0300
SPEED.50KHZ	1	BIN	23-Nov-88	23-Nov-88	\$40	A=\$0300
AUDIO.NORMAL	1	BIN	23-Nov-88	23-Nov-88	\$40	A=\$0300
AUDIO.SILENT	1	BIN	23-Nov-88	23-Nov-88	\$40	A=\$0300
AUDIO.DISTORTED	1	BIN	23-Nov-88	23-Nov-88	\$40	A=\$0300
AUDIO.MUSIC	1	BIN	23-Nov-88	23-Nov-88	\$40	A=\$0300
AUDIO.HIFI	1	BIN	23-Nov-88	23-Nov-88	\$40	A=\$0300
PAUSE.AT.RESET	1	BIN	23-Nov-88	23-Nov-88	\$40	A=\$0300
NOPAUSE.RESET	1	BIN	23-Nov-88	23-Nov-88	\$40	A=\$0300
ROCKET.WAIT	1	BIN	23-Nov-88	23-Nov-88	\$40	A=\$0300
APPLESPEED.WAIT	1	BIN	23-Nov-88	23-Nov-88	\$40	A=\$0300
TRANSWARP.COMD	1	BIN	23-Nov-88	23-Nov-88	\$40	A=\$0300
NOTRANSWARP.COMD	1	BIN	23-Nov-88	23-Nov-88	\$40	A=\$0300
STD.LANG.CRD	1	BIN	23-Nov-88	23-Nov-88	\$40	A=\$0300
NONSTD.LANG.CRD	1	BIN	23-Nov-88	23-Nov-88	\$40	A=\$0300
IIPLUS.NOBOOT	1	BIN	23-Nov-88	23-Nov-88	\$40	A=\$0300
IIPLUS.BOOT	1	BIN	23-Nov-88	23-Nov-88	\$40	A=\$0300
SLOT.CACHING	2	DIR	23-Nov-88	23-Nov-88	\$400	\$2000
..CACHE.SLOT7	1	BIN	23-Nov-88	23-Nov-88	\$40	A=\$0300
..CACHE.SLOT6	1	BIN	23-Nov-88	23-Nov-88	\$40	A=\$0300
..CACHE.SLOT5	1	BIN	23-Nov-88	23-Nov-88	\$40	A=\$0300
..CACHE.SLOT4	1	BIN	23-Nov-88	23-Nov-88	\$40	A=\$0300
..CACHE.SLOT3	1	BIN	23-Nov-88	23-Nov-88	\$40	A=\$0300
..CACHE.SLOT2	1	BIN	23-Nov-88	23-Nov-88	\$40	A=\$0300
..CACHE.SLOT1	1	BIN	23-Nov-88	23-Nov-88	\$40	A=\$0300
..CACHE.EXP.ROM7	1	BIN	23-Nov-88	23-Nov-88	\$40	A=\$0300
..CACHE.EXP.ROM6	1	BIN	23-Nov-88	23-Nov-88	\$40	A=\$0300
..CACHE.EXP.ROM5	1	BIN	23-Nov-88	23-Nov-88	\$40	A=\$0300
..CACHE.EXP.ROM4	1	BIN	23-Nov-88	23-Nov-88	\$40	A=\$0300
..CACHE.EXP.ROM3	1	BIN	23-Nov-88	23-Nov-88	\$40	A=\$0300
..CACHE.EXP.ROM2	1	BIN	23-Nov-88	23-Nov-88	\$40	A=\$0300
..CACHE.EXP.ROM1	1	BIN	23-Nov-88	23-Nov-88	\$40	A=\$0300
..NOCACHE.SLOT7	1	BIN	23-Nov-88	23-Nov-88	\$40	A=\$0300
..NOCACHE.SLOT6	1	BIN	23-Nov-88	23-Nov-88	\$40	A=\$0300
..NOCACHE.SLOT5	1	BIN	23-Nov-88	23-Nov-88	\$40	A=\$0300
..NOCACHE.SLOT4	1	BIN	23-Nov-88	23-Nov-88	\$40	A=\$0300
..NOCACHE.SLOT3	1	BIN	23-Nov-88	23-Nov-88	\$40	A=\$0300
..NOCACHE.SLOT2	1	BIN	23-Nov-88	23-Nov-88	\$40	A=\$0300
..NOCACHE.SLOT1	1	BIN	23-Nov-88	23-Nov-88	\$40	A=\$0300

Blocks free: 156 Blocks used: 124 Blocks in dir: 117 Total blocks: 280  
 Number of standard files: 62 Number of subdirectories: 2

published in Parallele 50 in 1950. Colossus 4 examined 488,815 positions in finding the key-move (A4-A1)!

White : B(d7) K(e5) R(a4) B(e1) Black : K(d3) P(g3)  
 Standard Apple // computer = 900 seconds

Rocket chip = 254 seconds an increase of 354%

Glen Bredon's Pi calculator is a quite small, well written, program which probably runs almost totally in the Rocket Chip's memory cache with only the minimum access to the Apple

computer memory at normal speed. Note how close Rocket Chip is to its ideal of 500%. Compare this with Colossus 4 which is a large program spanning the whole 64K bytes of Apple // memory and also writes to the screen as it calculates. Rocket Chip shows a very good 350% plus increase in execution speed which is probably due to its excellent memory management.

#### 4) Applesoft test programs

(See Figure 2) The first three simple test programs and others show that small Applesoft programs can expect at least 350% increase in speed of execution for calculations and string manipulation. String manipulation would be expected to be marginally slower than calculations since strings are stored in memory under HIMEM whilst their pointers are stored just after the end of the Applesoft program.

The fourth test indicates that programs that write to the screen would be expected to suffer a lot of degradation in speed, however, RocketChip does very well indeed and in a normal program such deterioration should be hardly noticeable. This example shows just about the worst case.

The fifth program shows that disk access proceeds at normal Apple speed and that there will be virtually not speed increase at all.

The sixth program is included to show the effect of badly designed rambling programs on the Rocket Chip.

#### 5) Apple Logo II

Tests with this program indicated a better than 370% increase except where some disk access was involved.

For example graph drawing showed better than 380% increase.

#### 6) Games

The games that I tested seemed to be affected by the Rocket Chip more than other programs with generally better than 410% was noted, with some increases as high as 460 per cent.

The RocketChip works well with most hardware; even DMA cards such as Z80 co-processors which will only work if you set the speed to normal Apple // speed (1.023MHZ). My Snapshot card works perfectly.

Most programs should be compatible; indeed I didn't manage to find a single program, including heavily protected programs such as Zardax 5.2, which would not work perfectly in the short time I had to examine them.

I was surprised to find that RocketChip starts up with a 2.1 second wait since this is an annoyance to most users, particularly just after installation!! If you defeat this wait of 2.1 seconds it remains in operation until you change it or switch off the machine and your Apple boots up just like the old 6502 or 65C02. The only slight problem is that you sometimes have to take two tries when you want to change from fast speed to slow speed and vice versa from the keyboard. Unless there is no overriding reason this 2.1 second wait should be removed; it's totally unnecessary; all the routine has to do is flag the keys pressed immediately on entry and then go about it's business leaving the user free. I'm still not entirely comfortable with the slightly shorter wait on my Apple IIs after 30 months.

For the time I have been using RocketChip I have had no real prob-

lems - Bits and Pieces have produced an excellent product that is compatible with all Apple // computers before the Apple IIs, indeed, it's more compatible than the Apple IIs.

Dave Ward



RocketChip is manufactured by :

Bits & pieces Technology, Inc.  
31332 Via Colinas, Suite 112  
Westlake Village  
California, 91362

info

Product : RocketChip  
Publisher : Bits & Pieces Inc.

Available from :  
MGA Softcat  
Pear Tree  
Appledore  
Kent TN26 2AR  
(0233) 83571

Price : £199.00

Value : ★★★★★  
Performance : ★★★★★  
Documentation : ★★★

Figure 2

Program	length#	Rocket Chip	Normal	% increase
P1 10 FOR M = 0 TO 4999 50000 NEXT M	23	1.9	7.1	373
P2 10 FOR M = 0 TO 4999 30 A = SIN(30) 50000 NEXT M	35	34.0	143.0	421
P3 10 FOR M = 0 TO 4999 30 A\$ = LEFT\$( "HELLO", 2) + "LLO" 50000 NEXT M	49	8.2	30.4	371
P4 10 FOR M = 0 TO 4999 30 PRINT "A"; 50000 NEXT M	33	4.8	16.8	350
P5 10 F\$ = "SCREEN, A\$2000, L\$2000" 20 PRINT CHR\$( 4) "BSAVE" F\$	49	6.3	6.8	108
P6 10 FOR M = 0 TO 4999 ## 50000 NEXT M	22253	659.0	2249.0	341

# Program lengths are in bytes

## This program contains 100 lines of very long REMarks.

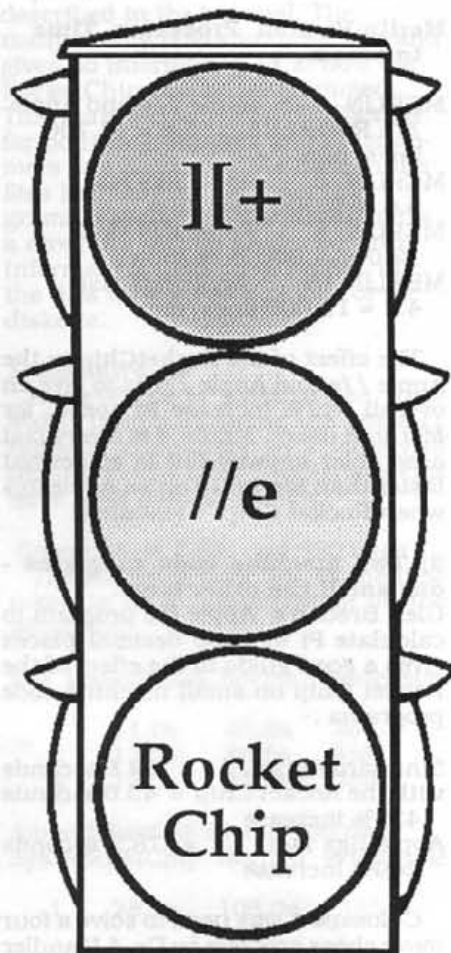



# Marble Madness

Richard Bradley gets himself into a spin reviewing the marble run game

This is a game for the Apple IIGS or the Apple //e or //c. On the Apple IIGS this game is brilliant. It is about a marble and you steer it along small tubes, walls and funnels and sometimes you fall off the end of the walls. It is a game where you race against time. The Marble is controlled by the joystick, keyboard or mouse. I found it easier to steer using the joystick. It is very difficult to play it on a green screen because you sometimes have to knock a black marble off the end of platforms to get a bonus of 1000 points and you are a blue marble or red if the two player game is chosen. So, on a green screen you can't tell who is who and you could kill yourself by falling from the platform. A colour monitor is a must!

On the //e you cannot control the marble very well, the screen seems smaller and the graphics aren't as good as on the IIGS. The sound on the IIGS is super, with a different tune for every level but on the //e the sound is not too good. It is harder to get from one level to the other on the //e. The creatures look like jellies and they can get you easier. On the Apple IIGS the marble can stop still but on the //e it cannot stop well and you go in other directions. You cross ice to reach some platforms but it is hard to cross on the //e.

Also on the //e you have to flip the disk every two levels, but on the IIGS you don't.

The object is to roll down hill until you reach the goal which takes you to

the next level. The faster you finish the better your score. When you have time left over the computer adds it to your time in the next level. If you run out of time you get swept away by a brush. There is a silly level where every thing is back to front. There is also a secret level, but I haven't found out how to get to it yet.

You must avoid the dangers like living pools of acid, aggressive bully marbles, hungry springs and birds.

It is a game for one or two players. You can turbo charge your marble when you press a button on the joystick or mouse. Inside the colourful strong packaging, you get one disk and a two page booklet which tells you everything about the game and how to use the keyboard commands.

The GS game is on a 3.5" disk and the //e game is on a 5.25" disk. The two different versions are packaged separately so you have to state whether you want the IIGS or //e game. The //e game will work on the IIGS.

Richard Bradley (Aged 13)



Marble Madness for both the Apple and the IIGs, costs £24.95 from MGA, Peartree, Appledore, Kent, TN26 2AR. Prices inclusive of VAT and post and packing.

## HOW WELL CAN YOU DRAW?

Now you can make your favorite Apple® II painting program look even better. With ThunderScan® ■ Simply snap the ThunderScan cartridge into your ImageWriter™ (except LQ) and you instantly have a powerful new imaging system for your IIe, IIc or IIGs that's fully compatible with most leading Apple II painting, drawing, graphics, and personal publishing programs.

■ Whether you're illustrating a term paper or creating a newsletter, you can use ThunderScan to import an endless variety of images into your favorite software—including Paintworks™, DeluxePaint™, DazzleDraw™, 8/16 Paint™ and MousePaint™ ■ ThunderScan lets you adjust brightness and

contrast without rescanning your artwork. You can select from three image modes: halftones, line art or color effects. And ThunderScan supports High Res, Double Res and Super Res displays. In fact, in the IIGs Super Res display you can see quality not found with any other imaging system. ■ Which gets us to the best part.

ThunderScan won't put a bite on your budget.



£219

When your image really matters.



**MGA SoftCat**

PEAR TREE  
APPLEDORE, KENT  
TN26 2AR ENGLAND

## HERE'S A STRIKING ILLUSTRATION.

TEL: (0233) 83571 FAX: 83561

PRICES INCLUDE p&p/VAT

# TransWarp GS

## Ewen Wannop belts up his IIgs, gets up to Warp Speed, and reviews the latest from Applied Engineering

### Background

The IIgs never captured the imagination of the buying public the way it ought to have. With its long pedigree stretching back to the first Apple I designed by Steve Wozniak, with its 16 bit processor its graphics and sound, its legacy of software from the Apple II, it should have been a runaway success. Except for the IIgs enthusiast, the IIgs has become a bit of an ostrich, hiding its head in the sand away from view.

The first time you use a IIgs, you are struck by the time that everything takes to happen. We had become used to the speed that the 6502 processor could be run. Programmed in assembler, running under ProDOS, programs like AppleWorks can be quite formidable and powerful beasts. An equivalent application running on the 65816 of the IIgs, really crawls in comparison.

The IIgs was intended to be the bridge between the historic concepts of the 40/80 column display of the Apple II and the WIMPS environment of the Macintosh. The Apple II series has 16k of Monitor ROM providing built in 'tools' for the programmer. Everything else has to be incorporated within the program code. This of course led to some excellent examples of tight and efficient code, and coupled with the basic lack of memory of the Apple II, gave us some extremely compact programs. The IIgs however, introduced us to the 'Toolbox' approach of the Macintosh, this with the ProDOS 16 disk operating system and relocatable program code, all programmers to wallow in the vast expanses of memory. This was a recipe for poor programming, and messy and slow execution.

None of this has been helped by the clock speed of the IIgs. The old Apple II ran at 1mhz, a speed much laughed at by the old Z80 programmers. However the short and efficient execution cycles of the 6502 made this the equivalent of the Z80 running at 2mhz. It is common on the Apple II to add an accelerator card which pushes this speed up to 2.5mhz. With the launch of the IIgs, we expected to see the 65816 running at least at 7mhz to show any marked improvement over

the Apple II. However, all we got was a clock speed which for all intents and purposes was only 2.4mhz. Using the toolbox for programming slowed things down to a crawl.

Because of this slow execution, many games do not use the true native environment of the IIgs, and run in a combination of 8 and 16 bit code under ProDOS 8, the 8 bit operating system of the Apple II. By this means they try to squeeze as much speed out of the IIgs as possible.

Why such a slow speed was chosen has never been made clear. At the time the machine was developed, fast chips were certainly expensive, but this should not have stopped the idea of a faster IIgs. It is always known that by the time a machine has really settled into the market place, chips will always become cheaper. It was suggested that the machine might pose too great a threat to the Macintosh if it ran too fast, but this idea has never been proved. It might well be that the IIgs was intended to be faster and that this was later changed before release.

There is evidence that changes in thinking were made to the Cortland/IIgs project during development. There is all the hardware, bar an odd filter or two (which there is even space for on the motherboard), to allow both NTSC and PAL composite colour video to be generated. In fact the Firmware Reference manual actually implies that softswitching bit 4 of \$C02B changes from the one output to the other. The reality is that the PAL output of the video encoder chip has been disabled, and that this softswitch simply changes the display rate from 50 to 60 hz.

Recently we have heard rumours of the IIgs+ machine. Like all rumours, this has developed into a description of our ideal machine. With the super hi-res colour display improved to 400 lines resolution and giving 16 colours in 640 mode instead of 4 and 256 colours in 320 mode instead of 16, the picture quality would improve to approach the Mac II. It would certainly have an equal if not better display than the Amiga. But, and here is the crunch, the rumours say that it will run at 10mhz, a quite respectable

starting speed for a IIgs and a very respectable speed for the old Apple II line. Of course rumours are rumours. There is no sight of a IIgs+ at the time of writing. We know that there are machines with the software developers, but whether these ever see the light of day on the production line is another matter, and whether they live up to our expectations is something else again.

### The Reality

A brand new disk operating system, ProDOS 16 or P16 for short, was developed for the IIgs. P16 was designed to be quite a different animal than the P8 it effectively replaced. For instance it allowed relocatable program code and access to an array of Toolbox commands. Inexplicably it was written mainly in 8 bit code. We have lived through various updates of the P16 system until we saw the release in 1988 of GS/OS V4.0, an entire rewrite of the old P16 operating system. This time it was in fast 16 bit code. Disk access was noticeably speeded up, a very necessary feature as the slow loading of P16 programs had been a hallmark of the IIgs from the start. At the time of writing, we have heard that GS/OS V5.0 has been announced, but not yet released. This promises us even faster disk access, and what is more important, faster Toolbox routines. Whether it lives up to the 'hype' is yet to be seen.

All these changes and improvements were inevitable on the software front. Bugs always get cleared, code is always streamlined, but it still does not change the fact that the IIgs is still running under a 2.4mhz clock.

Enter Applied Engineering who are renowned for their innovative expansion cards. They already market TransWarp accelerators for the Apple II series. These boards turn the Apple II into the fastest 6502 based machine that we have seen. It was rumoured some time ago that they were making a TransWarp for the IIgs. It has now become a reality and is on the dealers shelves now.

### The Hardware

For your money you seem at first to get very little. There is only a slim manual and an expansion board, however on closer inspection the TransWarp GS board is packed with a multitude of expensive and exotic chips. Square ones, tiny ones, ones on the back as well as the front and piggyback boards filled with chips. You begin to realise where your money went when you see how the complexity of the board.

Fitting the board is simplicity itself. Abiding to all the usual anti-static precautions you must first of all remove the existing 65816 processor chip from the motherboard. This will no longer be needed, as the TransWarp has a faster version of this chip



on board. You then plug a DIL header in its place. This header is attached to the TransWarp by a short length of ribbon cable. The board is then put into slot 3 and you are all ready for blast off.

Slot 3 is not normally available for extension cards, so is an ideal choice to house the TransWarp.

### Starting up

With my seat belt firmly fixed, I switched on the IIGs. It was disconcerting at first not to hear the usual beep, and so I stared at the screen with the horrible thought that I had installed the board incorrectly. All of a sudden there with the roar of a jet taking off, the TransWarp signon screen soared into sight in glorious rainbow colours. All was well, the TransWarp was working. If you get tired of the sound and light show, you can turn this off at the Control Panel.

There are no fancy key presses to control the TransWarp, as Applied Engineering has been able to make full use of the IIGs, and provide a built-in Classic Desk Accessory to control all the adjustable parameters. This simply loads itself into memory on startup.

### The Desk Accessory

Accessing the desk accessory gives you six choices.

#### Speed

#### Configure

#### Quick Self-Test

#### Continuous Self-Test

#### About TransWarp GS

#### Quit

### Speed

The TransWarp GS offers you a choice of three speeds, 1mhz, 2.6mhz and a notional 7.0mhz. The cards currently being shipped can only manage 6.4mhz due to a shortage of 'fast' chips. Applied Engineering include a voucher which entitles you to either exchange the card for a fast one when chips are available, or a discount off your next AE purchase. All the tests that I carried out were done with the 6.4mhz version.

The TransWarp CDA allows you to select Normal or Fast system speed. In the normal mode, the machine is set to 1mhz and the normal Control Panel speed control is changed as well. Set either at the Control Panel or at the TransWarp CDA, the fast mode follows the extra setting of the TransWarp Speed control. Set to normal you get the standard 2.6mhz of the IIGs. Set to TransWarp speed you get the notional 7.0mhz.

### Configure

If you wish to have a quiet life, you can de-select the startup Graphics and Sound with this option. Personally I get great amusement from the TransWarp logo every time I switch

on.

Although you should have no problems with the TransWarp GS working at fast speed, there may be some programs that require precise time-dependant routines. Access to the disk ports is always carried out at slow speed, but other time-dependant conditions cannot always be detected. AE have thoughtfully provided an option that checks the state of the AppleTalk/IRQ flag. If this is set, the speed is slowed to the normal IIGs speed of 2.6mhz, when cleared, you are back to full TransWarp boost. The sensitivity to this setting can be switched off from the Configure option.

### Quick Self-Test

This takes only a few seconds and checks all the various workings of the card. The continuous self-test simply prolongs the check period.

### About TransWarp GS

A display based on the startup logo is shown. There is good use of graphics with dissolving name credits into each other. A very nice touch.

### How the TransWarp GS works

The TransWarp works by simply replacing the main 65816 chip with a faster version which can run at up to 7mhz. However this is only part of the story as the mass of chips on board the card testifies. The IIGs not only has a slow processor, it has slow memory. To make the TransWarp work flat out, it is necessary to duplicate some of this as fast memory on the card, and use this for 'caching' programs as they run.

Put simply, many programs consist of code which loops round small sections as it operates. The TransWarp simply copies the code as it needs it into its own memory, and then runs from there. If the loop is entirely contained within the cached memory, the full speed potential is realised. However, if code jumps about and the cache needs to be constantly refreshed, a marginal speed loss will be noticed. The tests were done with this in mind, and show the variation one might expect.

Of course there is a lot of support hardware there for other functions as well.

### What else is available

In normal operation, you simply plug in the TransWarp GS card and forget it. If you are a programmer, you will want to play with the choices that the card can offer you. Applied Engineering have thoughtfully provided access to the on-board routines of the card. These are all accessed through a jump table at bank \$BC ranging from \$FF00 upwards.

A quick glance at the architecture of the IIGs will show you that there is nothing at bank \$BC, so we have little chance of any competition from any

other firmware.

The onboard routines allow you to interrogate the card, determine how many speeds it can handle, set these speeds, set the caching and other things. I do not expect many programs to take note of these commands, but it would mean for instance, that programmers could control time dependant events if they wished from within a program.

### The performance

The TransWarp I reviewed was not capable of the full 7mhz and was running at only 91% of the designed speed. This must be borne in mind when I get to the critical mention of timings.

Remember also that disk access is not improved, or if it is, it is so marginal to be insignificant. The real speed increase only shows when program code is being run, and this too is dependant on whether the target code can be successfully cached or not. If code jumps around, there will not be quite the same increase in speed that efficient code will show.

First impressions do not show a significant difference in speed. However, when you start to run programs that involve drawing the Super hi-res screen, things start to perk up. The Finder for instance now runs at a respectable pace, windows opening and closing with noticeable alacrity.

It is when we put the benchmark programs through their paces that we see where things speed up. The average increase is around 200%, but a small tight code test loop (figure 1) showed a 255% increase. This is an interesting finding when you calculate that the TransWarp is running at only 246% faster than the bare IIGs!

Figure 2 shows some sample timings for various events. I have included some of the test programs that Dave Ward used on the Zip chip for comparison (see October 1988 Apple2000).

### The drawbacks

These are minimal. There will be some games and some programs that will need to be run at either the 2.6mhz of the bare IIGs, or the 1mhz of the Apple II. You probably will be used to slowing down for many of these anyway.

You lose slot 3, only a slight drawback since it is normally unavailable. However if you already have a PC Transporter, a Sonic Blaster, a modem and a hard disc, you might have a few problems finding where to put them all!

### Conclusion

If you are running any programs that are either screen or calculation intensive, then the TransWarp GS is an absolute must. For the rest of us it may well be a luxury.

With the TransWarp fitted I found the IIGs a much more friendly beast,

and I did not get the usual feeling, of waiting impatiently for things to happen.

The TransWarp will no doubt become the thing to have very soon. I suspect no well dressed IIgs will be seen without one from now on!

Bidmuthin Technologies are bundling AppleWorks GS with the TransWarp for a combined price of £499.00 (ex VAT).

Ewen Wannop



info

Product : TransWarp GS  
 Publisher : Applied Engineering  
 Available from :

Bidmuthin Technologies  
 214 Kenton Road  
 Harrow  
 Middx HA3 8BT  
 (01) 907 8516

Price : £319.00 (ex VAT)

Value :            ★★★★  
 Performance :   ★★★★★  
 Documentation :  ★★★★

Figure 2

Action	IIgs	TransWarp
Launch AppleWorks	22	20
Sort 4843 record database with two fields	10	4.5
Timeout Search to end of 4843 records	4.5	2
AppleWorks GS check 'look' for synonyms	10	5
APW - assemble large program	567	325
Merlin - assemble Intro disk BOOT.CODE into memory	6	3
Run program in Figure 1	83	32.5
Run program P1	2.5	1.3
P2	53	24
P3	11	5.6
P4	6	3.6
P5	7.5	7.5

Figure 3

Test programs running in AppleSoft

```
P1  10 for M=0 to 4999
    50000 NEXT M
P2  10 for M=0 to 4999
    30 A=SIN(30)
    50000 NEXT M
P3  10 for M=0 to 4999
    30 A$ = LEFT$("HELLO",2)+"LLO"
    50000 NEXT M
P4  10 for M=0 to 4999
    30 PRINT"A";
    50000 NEXT M
P5  10 F$="SCREEN,A$2000,L$2000"
    20 PRINT CHR$(4)"BSAVE"F$
```

Figure 1

```
org      $300
loop dec  count
      bne  loop
      dec count+1
      bne  loop
      dec count+2
      bne  loop
      jsr $ff3a bell
      jmp  loop
count dfb 0,0,0
```

# Cool It!

## Dave Ward fights off IIgs fever and keeps his head cool

I've been running my Apple IIgs computer for the last two-and-a-half years without a cooling fan and since I only switch the machine and monitor off when it is absolutely necessary they get pretty hot; even the outer case of the machine feels quite warm. A symptom of this overheating may be the fact that the machine 'goes-down' approximately every 10 days and the lithium battery died after only 8 months. When I heard that Cirtech were introducing cooling fans for the Apple IIgs and Apple //e computers, only I decided to buy one and see what effect it might have.

The COOL-IT! fans are small (6cm square by 2.5cm deep) light weight (less than 3oz) and of plastic construction; metals only appear to be

used where they absolutely necessary (wires). These fans are bonded inside the machine rather than being mechanically fixed.

The Apple IIgs fan has five small adhesive pads on one face and when the protective release paper is removed from the adhesive pads the fan is simply pressed onto the metal power pack; the exact position is clearly described in the accompanying installation leaflet. All you have to do then is to plug it into the terminal at the back of the Apple IIgs motherboard. Installation of the Apple //e fan is just as easy except that the fan fits under the keyboard. Before bonding make sure that the surface you are fixing the fan to is clean, dry and dust-free; the adhesive pads bond very well to dust but the dust just falls off taking your fan with it!

During the three weeks I've had my COOL-IT! fan installed in my Apple IIgs the machine has not gone down and the outside of the machine is now cool; even the monitor appears cooler, too. These fans are also extremely quiet; in fact the quietest that I have come across. With no other sound in the room you can just hear a whisper from the fan.

The Apple //e fan is a very quiet too. I compared it with a fan that I purchased in 1984; that fan is rather noisy and is noticeable even with other sounds in the room; in fact in a

quite room that fan is a little annoying. The COOL-IT! fan, on the other hand, is a mere whisper.

I've found the Cirtech COOL-IT! fan very effective and unobtrusive. And it was a breeze to install! (Ha Ha .. Ed!)

COOL-IT! fans cost £28.00 plus VAT and can be obtained from :-

Cirtech (UK) Limited.  
 Currie Road Industrial Estate  
 Galashiels  
 Selkirkshire TD1 2BP  
 Scotland  
 Telephone 0896-57790

MGA SoftCat  
 Pear Tree  
 Appledore  
 Kent TN26 2AR  
 Telephone 0233-83571

Bidmuthin Technologies Limited  
 Brent House  
 214 Kenton Road  
 Harrow  
 Middlesex HA3 8BT  
 Telephone 01-907-8516

Holdens Computer Services  
 The Manslons  
 Chapel Lane  
 Longton  
 Preston PR4 5EB  
 Telephone 0772-615512

Dave Ward





# T-systems Ltd

COMPUTER SYSTEMS & COMPONENTS

T-systems Ltd  
The Signal Cabin, 61 High St.,  
Orpington, Kent, BR6 0JF

## Computer

DISKS, packs of 10, with labels etc

3.5" Sony disks, DS, 135 tpi	12.50
3.5" bulk packed, DS, 135 tpi	9.50
extra 100 x 3.5" disk labels	1.25

5.25" bulk packed, DS, 48 tpi	3.60
extra 100 x 5.25" disk labels	0.95
extra 100 x 5.25" disk sleeves	1.80
5.25" disk notcher	3.50
mouse mat	4.50

### DISK STORAGE

lockable, box for 40 x 3.5"	6.90
lockable, box for 80 x 3.5"	8.25
Posso, box for 150+ 3.5"	16.50
Vision 10 box for 10 x 3.5"	1.25
lockable, box for 50 x 5.25"	6.90
lockable, box for 100 x 5.25"	8.25

### PRINTER RIBBONS,

Imagewriter II, black	3.90
Imagewriter II, four colour	9.95
Imagewriter LQ, black	8.95

All prices include VAT and delivery  
ACCESS card accepted, telephone 0689 22196

# APPLE Games Gallery

■ Challenges the far reaches of outer space with the arcade excitement of *Quasar II*. ■ Tickle your kid's mind with educational adventures like *Mathmagician* and *Math Concentration*. ■ Takes you on perilous quests for fortune and fame with *Idol of Monterey*. ■ Deals a big hand of excitement with *Nibble Blackjack* and *Bridge Bidder*. ■ Puts you in command with *Artillery Duel* and *Surprise Attack*. ■ Brings home your arcade fun with *The Nibbler* maze and *Major Mahem*.

Your Apple Games Gallery has these and more of our very best games to entertain you, tease your imagination, and challenge your playing skills.

# you'll flip out!

with the best games collection of the decade!

I want Apple Games Gallery!

£29.95 book & disk

## MGA SoftCat

PEAR TREE  
APPLEDORE, KENT  
TN26 2AR ENGLAND

TEL: (0233) 83571 FAX: 83561

TELEX: 94070358 PEAR G  
PERSONAL COMPUTER SOFTWARE & ACCESSORIES

Whether you enter the games into your Apple II+, IIe, IIc, or IIGS yourself, using the easy-to-follow instructions, or run them with the optional disk, you'll be delighted with this incredible Gallery of fun!



PRICE INCLUDES BOTH POSTPAID BOOK & FREE DISK



# Amnesia

Dave Ward forgets himself long enough to review this new game from Electronic Arts

You wake up feeling wonderful but that soon fades as you try to remember where you are and even who you are! Looking around you see that you are in a bed in an unknown hotel room. Things just get worse when you get out of bed; you are naked and there are no clothes to be found anywhere. When you look in the mirror your features are completely at variance from those you expected, which only makes matters worse. Around the room you see an Apple computer, a bible and some keys that tell you that you are in the Sunderland Hotel room 1502. It's all like a dream, as you look at an Apple computer on its trolley you wonder why do hotel rooms have computers you reflect and how did you get here?.....

Well you purchased the software package AMNESIA from Electronic Arts. This consists of two 5.25 diskettes together with manuals in a brightly coloured wallet advertising the product and describing the game and its authors. The main program on the top side of disk 1, this is well copy protected the other three sides contain data to allow you to traverse your hotel and most of Manhattan and its subway system. This is a classical text-based adventure with nearly 4000 nodes or locations. To help you traverse such a large area you get a street and subway map, a visitors handbook and an address and telephone guide. A cross street indexer is also supplied which consists of two wheels; by moving the smaller inner wheel you can line up any two cross streets and get to the nearest intersection number in a little window. You'll need this as it literally saves your life on more than one occasion!! Without all these manuals you can't hope to play the game any yet you'll still need to make copious notes as you go along.

Initially this game is a nightmare, sometimes literally, too. You meet nice people who ask innocent questions and then pull a gun on you if you can't answer the question accurately, in their opinion. Elsewhere you meet women who karate chop you; you die, of course. Dying itself is not straightforward as you meet Charon who request your name - get that wrong

and you are given the choice of suicide or firing squad!

Fortunately, with such a complicated game you can save the current state of the game - do it often, as it helps you correct mistakes. The program, fortunately allows you to initialise blank diskettes and will save up to three game 'images' per disk side. You can also get a printout, if you wish.

The game has three score parameters to assess your ability:-

- As a detective.
- As a character.
- As a survivor.

You need your detective ability to find out who you are and clues are to be found as you go along, beware though because they may not be as helpful as they might appear. For instance, the Hotel staff refer to you as John Cameron, but Charon, the character who asks your name, does not know of John Cameron.

There are many pitfalls along the way such as being forced into a shotgun wedding. All ends happily, fortunately and you get a massive survivor score, but you don't win, of course!

Let's try booting the disk, this takes a minute or two and then you wake up feeling wonderful.....

Now you're on your own, no clothes, no money and no memory.

You've got to find out who you are and to do it you've got to travel the streets and subways of Manhattan, find money to buy food and get a place to sleep at night. If you don't you're sure to get mugged which leads to death and worse! Muggers abound the streets once night falls.

Amnesia is a very difficult interactive novel that I found enjoyable.

**Dave Ward**

Amnesia runs on the Apple ][+, //e and //c; price £22.99 ex VAT and P&P and is available from:

Chameleon Software,  
Cuckoo Lane, Pinchbeck,  
Spalding, Lincolnshire.  
PE11 3XT Tel: 0775 85481

In the Hotline news of April 1989 I asked for information from members who had succeeded in getting their Apple ][+ and other Apple // computers repaired, and would be able to recommend the repairer to other Apple 2000 members. Since then many more new users have contacted me regarding Apple ][+ computers that they have just purchased, without manuals and software. Many also report possible hardware problems, hence my request for help.

Well I've already had some feedback regarding Apple ][+ repairers. Three members mentioned Eric Sausse who runs ESCO Computers in Scunthorpe. Eric has repaired many Apple ][ plus computers and the three members who contacted me told me of good service at a reasonable price. Eric also stocks many Apple // components and accessories including disk drives, cards and manuals all at a reasonable cost.

David Pearce took the trouble to write to me to say that when his son's Apple ][+ computer went down he contacted COMTEC, who advertise in Apple 2000 magazine from time to time, and they charged him just £32.00 for the privilege of repairing and transporting the machine and drives via TNT. Service with a bank, eh!!

On a similar note many purchasers of Apple ][+ machines on the second-hand market find that they can also get 128K cards at very reasonable prices, too. Very few programs recognise these cards. The best thing to do is to place the card in slot zero to bring the machine up to a 64K Apple ][+; this saves buying a 16K memory card for slot zero which is otherwise essential.

When I had this set-up back in 1985 I wrote a ProDOS driver so that the remaining 7 by 16K memory banks on the card (112K) could be configured as a RAM drive. Although that driver and set-up program was published in Hardcore some years ago we will publish it again as soon as space is available. To write the driver for a 128K card in slots 1-7 would be much more difficult and perhaps some readers might like to offer to improve the driver?

If any member already has such a driver please let us have an article about it with a listing so we can publish it for the benefit of other users. PlusWorks will modify versions of AppleWorks 1.3 and less so that they will work on an Apple ][ plus. It has its own driver for Saturn type 128K cards in any slot; with a 128K card in slot zero and will give a 136K desktop.

**Dave Ward**





# Apple/Mac 89



Apple II  
Macintosh  
User Group Stands  
Special Interest Groups  
Trade Stands  
Bring and Buy  
Auction  
Notice Boards  
Consultants  
Lectures  
Refreshments

## Saturday 25th November

BAWA Centre - Filton - Bristol (Close to M32 Motorway)

All trade and other enquiries to: (0272) 693119 (evenings)  
or: Apple/Mac 89, 198 North Road, Stoke Gifford, Bristol, BS12 6PH

### New! EasyDrive 1.5™



If you have  
this . . .

. . . and  
this



. . . you need this

EasyDrive is, simply, the most important breakthrough in hard-disk technology — ever. It's the first and only complete software interface for the hard-disk (for Apple IIe, IIs and compatibles). Nothing else is faster or easier. With EasyDrive you get:

- Automatic self-installation
- Automatic program installation
- Fast program selection
- Fast, accurate back-up and restore
- File indexing
- Disk optimizer
- ProDOS 8 & 16, GS/OS compatible
- User friendly
- Expandable and upgradeable
- Free ProDOS book

TEL: (0233) 83571 FAX: 83561  
TELEX: 94070358 PEAR G  
PERSONAL COMPUTER SOFTWARE & ACCESSORIES



The Menu System will help you quickly launch and organize your most frequently used programs.

By displaying files and disk map simultaneously, TreeSurgeon gives you complete, easy control of your data.

The Status and Optimizer facilities maximize disk access speed on any ProDOS disk including 5.25" and 3.5" drives.

### MGA SoftCat

EasyDrive — £69.95

PRICES INCLUDE p&p/VAT

POWER FOR PERFORMANCE



PEAR TREE  
APPLEDORE, KENT PC  
TN26 2AR ENGLAND

# Applied Apple Spreadsheets

## (1) Getting the data in P F McMullin gives us an overview of this useful programming tool

It could be argued that the personal computer came of age when Visicalc was first launched (on an Apple II). It was intended as a financial analysis package. Both the hardware and software have come a long way since then. With memory expansion and accelerator cards we can now use electronic spread-sheets with greatly enhanced capacity. Spreadsheet programs can be useful in a wide range of applications involving complex manipulation of numbers.

In this series of articles we plan to discuss some "spreadsheets" techniques which can enhance the power of your spreadsheet applications (even if your computer has neither a large memory or accelerator card). In doing so we will be looking at of the key differences between some of the major spreadsheet programs in use on Apple II series computers today (mainly Visicalc, Appleworks and VIP Professional). Although Visicalc is not itself on the market anymore there are a number of "look-alikes", and, for those of us who started computing with Visicalc, it tends to remain the standard against which others are measured. In this article the emphasis is on getting your data into the spreadsheet. Next month we will look at some techniques to sort data in a spreadsheet and incorporate large blocks of data in pre-designed templates. The final article will discuss chronological manipulations in spreadsheets even when your program does not have built-in date functions. These techniques are useful for scheduling events with known intervals or calculating intervals between known dates.

### The Template Concept

Most of you will know well enough that an electronic spreadsheet is based on a two-dimensional grid in which each cell can hold numeric or alphanumeric data or a formula. That much is true for all spreadsheet programs. There are, however, important details of implementation which vary markedly among programs and which can have a significant effect on the amount and type of work which each program can accommodate, and on what is the best way

to solve a particular problem. To take one simple, but very basic, example let's look at how each of three programs load a previously developed template file.

Visicalc can only have one file in memory at a time but it does allow us to overlay a second template on the first (command : /SL). Each cell's contents read from disk replaces whatever is already in the cell (either data or formula). If the file on disk does not have anything in a given cell then its contents are unchanged. By successively loading a series of templates in Visicalc we can have the effect of a series of partially-transparent overlays, each doing different calculations on the same data (assuming the data are not overwritten by new data or formulae). The fact that this overlaying can be done does not mean that it should be done. Such multi-layered templates are difficult to design and maintain (a change in one template may necessitate changes to the whole series!). Most of the many Visicalc-clones mimic this overlay template-handling procedure.

Appleworks behaves quite differently. Although we may have a number of templates in memory at a given time there is no easy way to overlay one template on another. More importantly, there is no easy way of transferring data into a template (other than by manual entry) in such a manner as it will be available to the formulae in the template. This may be a normal way of handling data transfer for a database but it is certainly very strange for a spreadsheet! If we wish to perform a number of different manipulations on the same block of data we must either build a large template with each type of calculation handled in a different area, or, manually or otherwise, insert the block of data into each of a series of templates. Some tricks for getting around this problem are

described below (see the Appleworks Difference).

VIP Professional could be billed the natural heir to Visicalc. It is said to closely mimic the command structure of Lotus 1-2-3 but let's not hold that against it! It allows only one template in memory in the same manner as Visicalc but it does offer multiple choices for handling the loading of templates. It can Retrieve a file (/FR) in a manner equivalent to Appleworks loading a file or Visicalc clearing the sheet then loading a file. It can also combine a file (/FCC) to give the same sort of overlay effect as Visicalc.

However it does go a number of steps further in that it allows options to overlay only a given range of a template with that in memory, and it can also combine in such a manner as to add the disk template values to or subtract them from those in memory.

### The Ideal Template.

We must start by saying that the whole beauty of spreadsheet programs is that there is no ideal template. Spreadsheets are enormously flexible. However, I find the general template design shown in figure 1 a useful basis on which to design each new application. The blocks may be arranged horizontally (as shown here), or vertically, depending on the nature of the problem and the order of re-calculation used. This general concept of template design incorporating separate areas for data entry, calculations, and report generation is applicable to any spreadsheet program. See Figure 1.

### Manual Data Input

All spreadsheet programs allow the user to easily enter or correct numeric data in any cell at any time. For applications in which a very small amount of data is entered at a time and where each data set is only used in conjunction with one set of formulae (i.e. in one template) then this is fine. Many users will find however

that they would like to have the same data available to use in more than one template, especially when the number of data (and,

thus, the effort in entering them) is large.

### Auto Data Input.

The easiest and most flexible manner of handling blocks of data on a spreadsheet is to "cut and paste". Most spreadsheet programs allow this but, just as in the case of template loading described above, there are important differences among programs in how they do this. Such "cut and paste" techniques should ideally allow the program to transfer data





between different templates as well as being able to import from other sources (on-line data-bases, laboratory instruments, custom data-entry programs etc.). This operation is performed by the use of DIF format files by Visicalc and "standard text" format files by VIP Professional. Appleworks uses the "Clipboard" to transfer data and formulae between templates and supports DIF files for importing data but with the same serious limitations described above for templates (i.e. we cannot directly overlay data on an existing template, but see Appleworks Solutions below). By judicious use of "cut and paste" techniques it is possible to link 3 or four templates and carry out complex calculations even on systems with little free memory. You simply save the results from the first sheet in DIF format, load the second sheet and insert the DIF file, save the results of the second sheet, and so on until the job is done. There are two advantages of doing the job in 2 or three steps rather than on one gigantic sheet. The first has already been mentioned: it can be done on systems with little free memory. The second is that the smaller the sheet, the shorter will be the interval for recalculation. Templates which use this technique are also simpler to design and maintain than those which use multiple template overlays.

#### What are DIF files ?

The DIF format was developed by Software Arts Inc to provide a standard method of transferring data between different applications programs. This format is currently widely supported by spreadsheet programs and to a lesser extent data-base programs, and graphics generators. The files themselves are simply sequential text files written in a carefully defined manner which allows the receiving program to easily interpret the data. Although primarily intended for numeric data this format also handles alphanumeric data quite adequately. The details of the format have been published by the developers\* (<\*Software Arts Technical Note No. 18>) and users are encouraged to develop programs capable of supplying data in this format or of capturing and further manipulating data already stored in this format.

What are the advantages of using DIF files in spreadsheets ?

1. Blocks of data of any size can be "snipped" out of any area of a model. Only the result stored in the cell is transferred if the cell contains a formula.

2. These blocks of data can be returned anywhere they will fit on the same or any other sheet, normally replacing anything in the cells which are overlaid (but see "The Appleworks Difference" below)

3. When re-loading the file it is possible to "flip" so that what was saved as a column becomes a row.

4. Data stored in this format are readily available for transfer to other applications programs (especially graphics generators and data-base programs)

5. Data may be captured in this format from many sources (custom data entry programs, instruments, data-base programs, commercial on-line data-bases. Loading data directly from the file saves time and eliminates the risk of erroneous data entry in your spreadsheet.

#### The Appleworks Difference

Appleworks supports DIF files. True, but the spreadsheet does so rather poorly. I refer to the fact that it is not possible to load a DIF file directly into a previously prepared template (this is what DIF files were intended for after all!). We must first load the data into a newly created template, where it will begin at cell A1. To do this from the main Appleworks menu type : 1 <RTN> 5 <RTN> 2 <RTN> (Pathname of DIF file) <RTN> (Name of "new" spreadsheet) <RTN>. You may then transfer all or part of the data to the "clip-board" and from there to any position in your main template. This seems unduly complicated. As was mentioned above for templates, Appleworks is also atypical in that it is not possible to "overlay" the DIF file or data from the clipboard on a certain part of a spreadsheet. When data are transferred from one spreadsheet to any part of another the formulae in the existing cells are modified and are

Figure 1 - The Ideal Template.

Area A will contain numeric data. Area B holds formulae referring to cells in areas A or B. Area C holds formulae referring to cells in any of the three areas and shows results in a form suitable for printing.

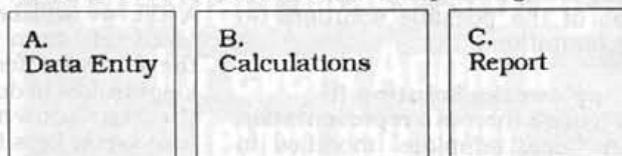
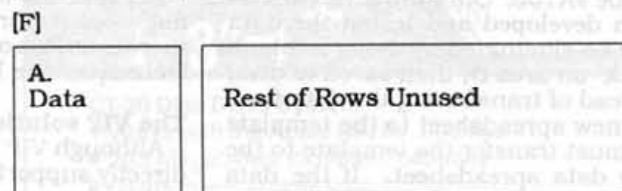
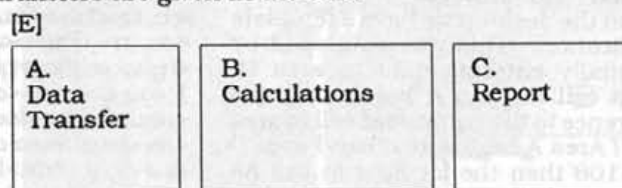

Figure 2. Appleworks Solutions.

Areas A,B, and C are the same as in Figure 1 except that area A is now a "transshipment" area for data in area D. Details of two methods of implementing block transfers are given in the text.



Announcing the latest version of the Fulltext system...

**fulltext** WORD • PROCESSOR  
PRO 80 SPELLING • CHECKER  
MAIL • MERGE  
COMMUNICATIONS

The complete word processing system that's a delight to use.

- A true "what-you-see-is-what-you-get" word-processor.
- All formatting and font changes (underline, bold, italics, subscript, size changes, etc) are shown on screen as you edit.
- All characters can be edited to produce different fonts, foreign characters, symbols etc -- all on screen and at your printer.
- Uses PrintShop(TM) type graphics which can be inserted anywhere in the text; the text will flow around the graphics! You can import graphics from any PrintShop library disk or create your own graphics using the in-built graphic editor.
- The whole system sits in memory so that it leaves your disk drive free for data disks -- except when using one of the many utilities.
  - Requires 128K //e, //c, //gs or Laser 128
  - Prodos based, fully compatible with all Prodos drives
  - Full printer control for a large variety of printers
  - Utilities include: English Spelling Checker, Mail-merge Character editor, DOS 3.3 file loader, Word-sort, File transfer, Disk formatter, Ramdisk installer.
  - Reference and Examples manuals
  - Five lesson files take you through tutorials for fast learning.
  - All command-driven using the most obvious key-letters.

Designed for home, office and classroom. Just brilliant! Write for details today:

**Specific Software** £85

P.O.Box 58, Morpeth, Northumberland, NE61 1EQ

NOW WITH GRAPHICS!

effectively "shunted down" to make room for the transferred data. This makes it very difficult to develop a standard template with formulae which can import data. However, nothing is impossible. Let us look now at two of the possible solutions to these limitations.

### The Appleworks Solution (i)

In Figure 2 there is a representation of our "ideal template" modified in such a manner that it may be made to work with clipboard transfers in Appleworks. We start off with the data in the DIF file loaded into a "new" spreadsheet as defined above. In a second spreadsheet file on the desktop we have a template application. This was developed by manually entering data in area D. Each cell in Area A holds a simple reference to the equivalent cell in area D. If Area A begins at A8 and area D at A108 then the formula in cell A8 will be +A108. Once the template has been developed and tested the data may be eliminated by doing a "blank block" on area D, then saved to disk. Instead of transferring the data from the new spreadsheet to the template we must transfer the template to the new data spreadsheet. If the data begin at A2 (line 1 is usually just labels) and the data transfer area "looks" for data beginning a cell A108 then you must transfer 106 lines to the clipboard and from there to the new spreadsheet. If you put any value in cell A106 and make the new or data spreadsheet the file immediately before the template on the desk-top the following macro will perform this operation:



Taking the same example given above (transfer beginning at A8 and Data loaded at A108) make the formula in cell A5 (identified as E in figure 2) be +A105 (refers to cell identified as F). Of course, there being no data in cell A105, we will be using cell A5 as a "seed cell" from which to write all of the formulae for area A. The basic key-strokes to do this would be: <oa-C><rtm><down><down><down>. (use arrow keys to place the cursor at the bottom right of area A) <rtm>R (for Relative) <oa-K>.

The following set of macros will allow a standard transfer of a block of data 10 cells wide and 40 rows high when the cursor is on the seed "cell".

```
<down><down><down><down><down><down>
<down><down><down><down><down><down>
<right><right><right><right><right><right>
T:<oa-C><rtm><down><down>
<down><sa-down><sa-down>
<sa-down><sa-down><sa-right>
<sa-right><rtm>R<oa-K>
```

Because the template formulae are not copied through the clipboard there is no loss of formatting using this technique. See Figure 2.

### The VIP solution.

Although VIP Professional does not directly support DIF format data files it does have commands to extract a block of data from one worksheet (/FXV) and insert it in another (/FCC) in a manner identical to DIF files in Visicalc. It also allows us to import text files ("standard-format") from other programs (/FIN) as if they were DIF files. Such files must be very carefully constructed if VIP Professional is to interpret them correctly. One way of achieving this is to generate or modify text files with simple programs written in BASIC. Listing 1 shows such a program which reads a text file in DIF format and converts it into a file which will be correctly interpreted by VIP's /FIN command. Only the sub-routines necessary for the file manipulation are included here. A fully-fledged program would probably also include modules to allow file selection, enter a name for the new file, print messages to the screen, etc. Space precludes a detailed discussion here of programming techniques for reading and writing DIF files. See Software Arts Technical note #18 and later Visicalc manuals for details.

P F McMullin

### COMING UP !!!

Having got our data into the worksheet, by hook or by crook (and sometimes both) we will be looking next time at some unusual ways in which it can be manipulated.

### LISTING 1

A short program to convert DIF files into a format which will be correctly imported into VIP Professional.

```
100 D$=CHR$(4):GOTO 2000: REM
    GOTO MAIN
308 INPUT T,V$: INPUT S$: RE-
    TURN :REM SUB-ROUTINE TO READ
    DATA POINT
350 PRINT D$"OPEN "FD$: PRINT
    D$"OPEN "FV$: REM SUB-ROUTINE
    TO ACTUALLY DO CONVERSION
351 PRINT D$"READ "FD$: INPUT
    A$: GOSUB 308: IF A$ < >
    "DATA" AND A$ < > "data" THEN
    351:REM READ THROUGH AND
    DISCARD HEADER
352 PRINT D$"READ "FD$: GOSUB
    308:V = VAL (V$): PRINT
    D$:"WRITE "FV$: IF S$ = "EOD"
    OR S$ = "eod" THEN 358 : REM
    READ DATA POINT, IF END THEN
    FINISH
353 IF T = 1 AND V = 0 THEN
    PRINT CHR$(34);S$ CHR$(34)"
    "; GOTO 352:REM PRINT TEXT
    AND LOOP BACK FOR MORE
354 IF T = 0 AND S$ = "V" THEN
    PRINT V$" "; GOTO 352:REM
    PRINT NUMBER AND LOOP BACK FOR
    MORE
355 IF T = - 1 AND V = 0 AND
    (S$ = "BOT" OR S$ = "bot")
    THEN PRINT : GOTO 350 : REM
    IF END OF LINE PRINT CARRIAGE
    RETURN AND LOOP BACK FOR MORE
356 PRINT "XXXX " : GOTO 352 :
    REM PRINTS "XXXX " TO FLAG A
    DATA POINT WHICH WAS NOT IN-
    TERPRETED AND LOOP BACK FOR
    MORE
358 PRINT CHR$(0): PRINT
    D$"CLOSE"
359 RETURN
2000 REM MAIN PROGRAM SHOULD
    DEFINE FD$ AS THE PATHNAME OF
    THE SOURCE (DIF) FILE AND FV$
    THE PATHNAME OF THE DESTINA-
    TION (VIP) FILE.
2020 FV$=FV$+".PRN" :REM ADD
    SUFFIX REQUIRED BY VIP
2100 GOSUB 350
2200 HOME:PRINT "THE DIF FILE
    "FV$: PRINT "HAS BEEN CON-
    VERTED INTO THE VIP DATA ":
    PRINT "FILE "FV$:END
```





## SoftCat Corner

□ With Reference to B McHugh's letter pp36/37 Feb 89 regarding Apple II LOGO/Prolog. On the Prolog front, I have only once seen a reference to availability on the Apple II. Apparently, in 1987 Apple Computer Inc. surveyed the marketplace with regard to various languages and tools available to developers. Programming Logic Systems of 31 Crescent Drive, Milford, CT 06460 (0101-203-877-7988) advised Apple that they had available "LPA Micro-PROLOG v3.1" for the Apple II. I did write to PLS on the 8th of April 1988, but have yet to receive a reply from them ... if Mr McHugh is serious about pursuing this perhaps some sleuthing will be in order ...

□ On the lower case front, of course the best way is to install an 80-column board, which in most cases will give not only 80-column text, but also lower-case as well as inverse characters. Should this route prove too expensive, MGA actually do still stock a ready-made lower-case adaptor (Part No. APX-LCA02-1) for just £14.99.

□ K John Kishtimoto on page 14 of the December 1988 magazine reviewed Epyx's Destroyer. A 128k 5.25" version is also available to //e and //c users.

□ Members may be interested to know that the current version of Statsoft's "APPSTAT" reviewed by Mike Tickle in the same magazine, is now called "APPSTATS & GRAPHS" and now includes the excellent "MAGNA CHARTA" statistical graphing program from Third Wave Technology at no extra cost (for a limited time...)! Maybe Mike should do a follow-up review of the new version ...

□ With reference to Heide Schmitz' letter regarding Apple II hint/tips etc. If anyone is really interested in obtaining lots of information regarding the earlier Apple II models, perhaps the best place to look is in the bound back-issues of Open-Apple (now A2 Central) newsletter. If serious Apples want to know what might be contained in the four bound volumes, MGA will send photocopies of the indices free of charge. Each volume costs £19.95.

□ The next series of hints/tips comes from the Nibble magazine stable, and are called "Apple Secrets" & "More Apple Secrets", at £19.95 each, they also have companion disks at £10.00 to save you having to type in the programs and utilities included. Full details on request.

□ The third series of bound volumes is also from Nibble. The best utilities, games and productivity programs from back issues of the Nibble magazine have been bound for you from £14.95 to £19.95 each. Seven volumes of "Nibble Express" are currently available, the first two costing £14.95, the third and fourth costing £17.95 and the last three at £19.95 (each). Full details from MGA.

□ With reference to H Skilbeck's letter in the February magazine regarding Apple //c printers. I think that generally speaking the reply was correct to the question, however, it probably would have been more worthwhile to point out that it is possible to easily obtain a simple interface for the //c that will allow easy connection of parallel printers. Such a device is available from MGAS, and it is a stock item. This particular model is made by Apricorn of San Diego and is called "Apricord //c", the price is just £49.95. To install, the Apricord //c couldn't be simpler, you only have to plug the 5-pin DIN connector into your //c and the 36-way Centronics connector into the parallel printer. The Apricord //c uses the default settings of the //c serial port so no changes are necessary.

□ Also in the February issue was a letter from Berthold Instruments regarding Accelerators. More recently than the Titan Accelerator, we have seen the introduction of two alternatives which are much more cost-acceptable. The first is the Applied Engineering TransWarp Accelerator which although listing at £219.00, is actually available from MGA for just £179.00.

□ The second device, of course, is the much heralded "Zip-Chip" from ZIP Technologies, which costs £179.00 and was reviewed in the October 1988 magazine.

\* **Jon Gurr** (partner, MGA SoftCat)

\* All prices include VAT and Post and Packing from MGA

## Chinook Hard Drives. Compact Mass Storage for every Apple II (even the IIc!)

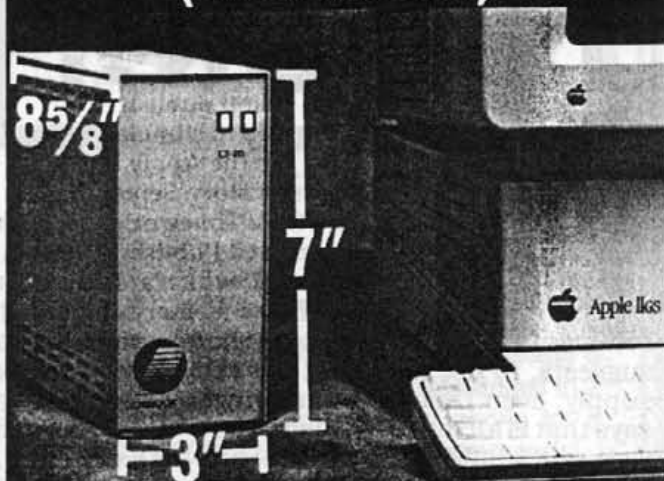

### CT-20 Disk Drive System

- Works with the Apple II+, IIe, and IIgs
- 20.5 Megabytes, formatted capacity
- 68 ms average seek time
- SCSI interface
- Price — £699

### CT-20c Disk Drive System

- Works with the Apple IIc, IIc+, and IIgs
- 20.5 Megabytes, formatted capacity
- 68 ms average seek time
- SmartPort interface
- Price — £699

### CT-40 Disk Drive System

- Works with the Apple II+, IIe, and IIgs
- 40 Megabytes, formatted capacity
- 28 ms average seek time
- SCSI interface
- Price — £899

### All Chinook Disk Drive Systems

- Come with everything you need — External disk drive, controller card, system and power cables, EasyDrive disk management software

- One year warranty on parts and labor

### PRICES INCLUDE p&p/VAT

- No extra fees for shipping or charge cards
- We accept — Mastercard/Personal Check/Money Order/School P.O.



CHINOOK

## MGA SoftCat

PEAR TREE  
APPLEDORE, KENT  
TN26 2AR ENGLAND

TEL: (0233) 83571  
TELEX: 94070358 PEAR G

Apple II+, IIe, IIgs, IIc, IIc+ are registered trademarks of Apple Computer, Inc.  
EasyDrive is a registered trademark of Quality Computers.



# The Nibbler

Quite a bit of interest was stirred up by Ewen's article on building your own SCSI drive. Ewen tells me that John Robertson of Cirtech has made some relevant comments. It would be unwise he suggests, to use a 13 watt power supply, even though the manual says that is all that is needed. A 30 watt unit would be safer. As John also points out, it would be difficult to get one as small as 13 watts in any case. Also Seagate do various things with their terminator connections, and you may find that the correct power supplies are not necessarily brought out to the SCSI connector. This is no problem John tells us if the terminators are used internally, but could be a problem with long SCSI leads if external terminators are used. If in doubt, or you get odd things happening, check that the power is getting to the correct pins on the SCSI connectors.

Derek Hughes of Seagate Software Developments has left a message on TABBS to say he can provide the bare ST277N drive. Not quite at the price that Ewen quoted, but at around £400 inclusive for a 62 mb unit, still a very good bargain. He can also supply a 28ms version for around £50 more. Give Derek a ring on 0695 738170 (evenings).

Talking of prices, I was interested to see the file on TABBS giving all the US prices of Macintosh equipment. Apart from my immediate reaction of 'Cor what a lot of stuff', it was interesting to compare prices the two sides of the pond. As we have been talking about hard drives, the Apple HD20SC with cables costs £821 (inc VAT) in the UK and \$899 (£560) in the States. A very desirable Macintosh IIcx 4/80 costs

£5042 (inc VAT) in the UK and \$7069 (£4404) in the States. These are the SRP's, so discounts would have to be taken into account. It does mean that the dollar=pound equation is not quite what it was. If only this applied to peripheral items and software as well!

However, Laurence Byrne from Ireland has given me some prices of Apple machines in the Emerald Isle. The HDSC20 without cables costs 937 pints (£804) and the IIcx 4/80 costs 6743 pints (£5783). Laurence also adds the following items of interest to readers of the first half of the magazine. A 128k 80 column //e system with 5.25 drive costs 750 pints (£643) and a 256k IIGs system with 3.5 drive costs 1000 pints (£857). These prices include Irish VAT at 25%.

If you can get a IIGs system shipped to you without the VAT and then pay the normal customs and duty, it would cost you £823. The normal SRP in the UK is quoted at £1144. Trust the Irish to do things oddly.

It was mentioned in the last Slices that Prestel had added VAT to all its prices. It was thought this was another way of Prestel getting more money from the customers. It seems, however, that this was another ploy of the Government to get even more money out of the public, and that Prestel is fighting the imposition all the way. We hope they win this one.

However, it is not only the Prestel branch of Dialcom that is upping and changing its prices. IPSS has decided to alter its pricing structure. Until now, a time or connect charge was made, and then you paid for the 'packets' or 'segments' of data on a volume charge. From the first of June, a volume only charge will be made with a threshold minimum charge.

The net result to your pocket will depend on the kind of access you do. For those simply browsing, and thus not involving much transfer of data, the costs will either stay the same or may even

go down. For those downloading a great deal of data, the charges will rocket. IPSS charge per segment of data, each segment being 64 characters. A charge of 0.56p per segment to the States may not sound great, but when you consider an average screen may contain around 960 characters, or 15 segments, 8.4 pence sounds a lot for one screenful.

If you download software or bulk data, you are transferring anything up to 7200 characters a minute. This would cost you 63 pence or £37.80 an hour. However, that would be the charge if data was only going one way. When you download, you are sending constant acknowledgements back to the host. Each single byte ACK takes up one segment as it is sent. IPSS has no way of telling if the segment is full or has only one byte, so you are charged for the full segment. This means that you have almost continuous data flowing in both directions during a download. To put it another way, it could cost you up to £75.60 an hour, and that does not count the online charges of the host database. It is cheaper to ring up your granny in Australia on the voice lines than pay for that lot.

AppleFest in Boston released various new items. Those of you who habituate TABBS will have seen the extracts from CIS that Andreas Wennborg has posted describing events that weekend. Amongst other things, Apple have launched a new GS/OS V5.0. The new system is supposed to speed up everything from the ToolBox to disk access. However, we only have Apple's word for it, we shall not see the actual system released till sometime in July. When it comes, we shall endeavour to get it up onto TABBS and into the library, as soon as possible.

The year is almost half gone now, and the next Apple II has not yet been seen. Those of you with long memories (in computer timescale) will remember that John Sculley launching the IIc+ (why is that not sold here in the UK ...?), promised us a new Apple II before the end of 1989. We all assume this will be the IIGS+, but who knows, it might be a nostalgic re-release of the Apple I. Anything seems possible these days.

The Nibbler





# COMPUTABILITY

PO Box 1 Hedge End Southampton SO3 4QJ

Telephone (0489) 786229

## Shareware and Public Domain Software

The latest shareware and public domain software from the USA for the Apple ][+, //e, //c, IIGS and compatible computers.

*Over 300 disks with great low-cost software!*

Send a large SAE for a free copy of our Summer 1989 catalogue, or contact us direct - we accept Access and Diners Card on telephone orders.

We sell a wide range of disks - from Business to Education, Graphics, Games, Utilities and the Eamon adventure series. We now also have PD software for the IIGS!

We have a large collection useful Appleworks files from The Appleworks User Group too.

**C04 Fredwriter** - an excellent word processor, one of the best PD disks on the market. (Runs under ProDOS, needs lower case and 64K to run).

**224 Vocabulary Extension 1** - grammar quizzes for ages 14 upwards, subjects include synonyms, antonyms and word arrangement. (Runs under DOS, is menu driven and runs on any 48K Apple II or IIGS).

**322 Public Domain Defender** - is the PD version of the great arcade game. The object is the fly your space craft and destroy aliens. (Runs under DOS, requires 64K plus a joystick).

**A08 Le Grayhaven Cookbook** - an electronic recipe filebox with recipes ready to use in your kitchen. You can print them out and add your own. (Runs under DOS).

**013 to 089 Print Shop Graphics** - these are an exciting and varied collection of graphics, fonts and borders for use with the commercial programme Printshop. (They all run under DOS and are supplied with a sheet showing, at a glance, which graphics are on the disk).

**457 Yo Yo Duck** - a shareware disk holding a wonderful diagnostics programmes for the Apple //e, //c and IIGS. Using it, you can test cable connections, the monitor and video chip and much more! (Runs under ProDOS).

And for the IIGS only - supplied on 3.5" disks. **GS01 Desktop 1** - a good value double sided disk with several desktop accessories, including Diversi-Key, Diversi-Cache and Diversi-Copy.

Public Domain and Shareware Disks, both 3.5" GS and 5.25"

**Only £3.95 each**

Price *includes* postage, packing and VAT.

You pay only for administration and distribution costs.

**COMPUTABILITY**

PO Box 1 Hedge End Southampton Hants SO3 4QJ.

Tel: (0489) 786229

## PUBLIC DOMAIN SOFTWARE & SHAREWARE

We have large selections of the *best* Public Domain Software & Shareware for the Apple II & Apple Macintosh range of Computers.

### Macintosh

£4.99 per 3.5" disk  
Each disk at least 95% full

### Apple II & Compatibles

From £3.75 per 5.25" disk

All prices are *fully inclusive* of VAT, postage & packing. All orders are normally dispatched in 2 working days of receipt. Write or phone for a **FREE CATALOGUE** stating your computer(s).

### Kingsway Computer Services

140 Rushdale Road, Sheffield S8 9QE  
Tel (0742) 588429

## COMPUTER DOWN !

- **FAST TURNROUND - NORMALLY 2 DAYS**
- **3 MONTH WARRANTY**
- **COMPETITIVE PRICES ON ALL SERVICES**
- **TRADE ENQUIRIES WELCOME**
- **Most makes of COMPUTER, MONITOR, PRINTER**

**EXAMPLES ALL INCLUSIVE PRICES**  
APPLE][ + OR //e Power Supply £32  
APPLE][ + OR //e Motherboard £32  
Apple Interface Card (most makes) £25  
Disk Drive - cleaned & aligned £25

**Please ring for other repair prices or send equipment for free estimate**

**Quantity Discounts available**

## SUPERCHARGE YOUR MACINTOSH AVAILABLE NOW !

**1MB SIMM'S - EASY TO INSTALL**  
Take your Mac+/SE to 2.5MB or even 4MB  
Take your Mac II to 5MB or even 8MB  
**WE WILL NOT BE BEATEN ON PRICE**  
**TRADE ENQUIRIES WELCOME**

## NOW IN STOCK

MacPlus Connectors, Serial & AppleTalk  
Price depends on quantity

## COMTEC

**UNIT G, SUNDERLAND HOUSE  
SUNDERLAND STREET  
MACCLESFIELD, CHESHIRE. SK11 6JF  
TEL (0625) 34691**

## MacLine now has the lowest priced memory in Europe

**1 Mb  
low profile  
100 nanosecond  
fits any Macintosh**

**£295 for 2 MegaBytes**

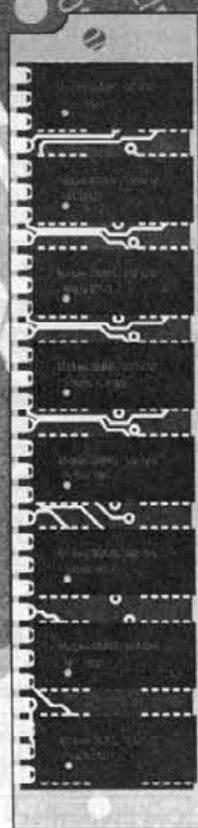

### UTILITIES & DAs

<b>Acta Advantage</b> (Outliner includes DA version) .....	95.
<b>Calculator Constructor</b> (create DA calculators) .....	32.
<b>Top Honors</b> (Design PostScript certificates) .....	69.
<b>Certificate Maker</b> (Design bitmap certificates) .....	25.
<b>Top Honors</b> (Design PostScript certificates) .....	69.
<b>Calendar Maker</b> (customise calendars) .....	27.
<b>Capture</b> (screen image capture) .....	39.
<b>Copy II Mac</b> (backup protected software) .....	23.
<b>Disk Express</b> (speed up, unfragment hard drives) .....	34.
<b>Disk Quick</b> (catalogues floppy and hard discs) .....	32.
<b>Disk Tools Plus</b> (9 essential DAs) .....	39.
<b>Epstart</b> (run an Epson serial printer) .....	35.
<b>Fedit Plus</b> (file and disc editor) .....	29.
<b>Font/DA Juggler</b> (multiple DAs & fonts) .....	39.
<b>Gofer</b> (search key words on multiple text files) .....	54.
<b>NFS Backup V3</b> (new faithful HD backup) .....	55.
<b>Hyper DA</b> (read HyperCard files from a DA) .....	39.
<b>Icon II</b> (design flexible icon menu bars and more) .....	49.
<b>MacInUse</b> (register time spent on applications) .....	59.
<b>Master Juggler</b> (Suitcase II rival) .....	59.
<b>MultiClip</b> (multiple copies & pastes) .....	39.
<b>On Cue</b> (switch between progs avoiding finder) .....	35.
<b>QuickKeys</b> (the best macro maker) .....	69.
<b>QuickDex</b> (lightning fast DA database, essential) .....	35.
<b>Redux</b> (best backup program on the market) .....	59.
<b>Screen Gems</b> (colour utility collection) .....	49.
<b>Stepping Out 2</b> (a big screen for £55!) .....	55.
<b>Smart Alarms</b> (new version DA reminder system) .....	49.
<b>Suitcase 2</b> (manage 100's DAs & fonts) .....	49.
<b>SuperSpool</b> (best ImageWriter spooler) .....	59.
<b>SuperLaserSpool</b> (Laser & ImageWriter spooler) .....	89.
<b>SUM</b> (essential utilities plus guard against crashes) .....	65.
<b>Smartsrap &amp; Clipper</b> (better scrapbook) .....	49.
<b>Tempo II</b> (macro maker, timesaver) .....	85.
<b>Thunder II</b> (best spelling checker) .....	59.
<b>Virex</b> (virus tracer & eradicator) .....	59.

### WORD PROCESSING

<b>Acta Advantage</b> (Outliner includes DA version) .....	95.
<b>Expressionist 2</b> (DA equation processor) .....	79.
<b>MindWrite</b> (amazing outliner WP) .....	155.
<b>MacWrite II</b> (major update handles graphics) .....	89.
<b>Microsoft Word 4</b> (the new standard) .....	209.
<b>Nisus</b> (fast maths oriented programmable word proc) .....	245.
<b>Thunder II</b> (best spelling checker) .....	59.
<b>Vantage</b> (excellent DA WP that was MacSink) .....	89.
<b>Wordfinder</b> (220 000 word DA Thesaurus) .....	35.

### DTP

<b>LetraStudio</b> (font manipulation DTP) .....	395.
<b>PageMaker 3</b> (the most intuitive) .....	429.
<b>Quark Xpress 2.1</b> (the most powerful) .....	495.
<b>Quark Style</b> (mini Xpress with templates) .....	245.
<b>Ready, Set, Go 4.5</b> (the most features) .....	425.

### GRAPHICS

<b>Canvas 2</b> (amazing power, colour paint & draw) .....	175.
<b>Comic Strip Factory</b> (create your own comics) .....	49.
<b>Cricket Draw</b> (PostScript Draw program) .....	175.
<b>Claris CAD</b> (state of the art CAD) .....	550.
<b>Desk Paint</b> (full paint/draw progs in a DA) .....	75.
<b>Dreams</b> (new generation CAD) .....	249.
<b>Freehand</b> (PostScript art and text) .....	365.
<b>Illustrator 88</b> (auto trace, colour, blending...) .....	425.
<b>Image Studio</b> (grey scale image control) .....	425.
<b>McCalligraphy</b> (stunning Japanese style painting) .....	175.
<b>MacDraft</b> (biggest selling drafting tool) .....	175.
<b>MacDraw II</b> (the classic draw program) .....	325.
<b>Streamline</b> (Adobe autotracer) .....	295.
<b>Showcase FX</b> (colour titling for TV/video etc) .....	225.
<b>SuperGlue</b> (save and transfer any file or image) .....	55.
<b>Super 3D ver 2</b> (colour Mac II support) .....	295.
<b>Studio 8</b> (new colour paint program) .....	255.
<b>The Curator</b> (best clip art database) .....	89.

### PROGRAMMING

<b>Lasertalk</b> (PostScript language editor) .....	169.
<b>Lightspeed C 3</b> (with source level debugger) .....	109.
<b>Lightspeed Pascal</b> (highly rated) .....	69.
<b>Programmers Online Companion</b> .....	35.
<b>QuickBasic</b> (Microsoft's version) .....	85.
<b>Prototyper 2</b> (design interface autogenerate code) .....	155.
<b>TMON</b> (superb debugging tool) .....	98.
<b>True Basic</b> (by the original author of Basic) .....	65.
<b>ZBasic 5</b> (the latest Basic available) .....	125.
<b>VIP 2.5</b> (programmable flowcharts) .....	89.

### CLIP ART

<b>Visual Arts 1</b> (quality PostScript clip art) .....	65.
<b>Visual Arts 2</b> (business orientated images) .....	75.
<b>Comic People</b> (bit map comic characters) .....	42.
<b>WetPaint</b> (the best bit map art by miles) .....	each 49.
"Classic Clip Art" "Animal Kingdom" "Printers Helper" "Old Earth Almanac" "Industrial Revolution" "Far Publishing" "Special Occasions" "Island Life" "People	

### BUSINESS

<b>101 Macros Excel</b> (diverse and useful macros) .....	49.
<b>Cricket Graph</b> (top graphing tool) .....	119.
<b>Cricket Presents</b> (presentation tool) .....	295.
<b>MacMoney 3</b> (home, small business accounts) .....	75.
<b>MacProject II</b> (superior new version) .....	325.
<b>Microsoft Excel</b> (the power spreadsheet) .....	209.
<b>Microsoft Works 2</b> (5 integrated programs) .....	159.
<b>MicroPlanner Mac</b> (Project manager) .....	399.
<b>Persuasion</b> (Aldus' new top end presentation) .....	365.
<b>SmartForms Designer</b> (Clarisc' new forms package) .....	325.
<b>PowerPoint</b> (desk top presentation tool) .....	209.
<b>Wall St. Investor</b> (analysis and database. New vers.) .....	450.
<b>Wingz</b> (best spreadsheet available) .....	255.

### DATABASES

<b>C.A.T</b> (contacts, activities, time-sales aid) .....	245.
<b>DAbase</b> (new full featured DA database) .....	89.
<b>Double Helix II</b> (easiest major database) .....	365.
<b>Filemaker II</b> (versatile and powerful, superb) .....	199.
<b>Foxbase+ Mac</b> (dBase III PC compatible) .....	309.
<b>Foxbase+ Multiuser</b> (Network version) .....	495.
<b>Omnis Accounting</b> (For all 5 modules) .....	395.
<b>Omnis 3 Plus</b> (now the best value by far) .....	149.
<b>Omnis 3 Multi User</b> (Network version) .....	425.
<b>Panorama</b> (spreadsheet like database) .....	225.
<b>QuickDex</b> (essential lightning fast DA database) .....	35.

### HYPERCARD

<b>DTP Advisor</b> (tips and advice on layouts) .....	59.
<b>Focal Point</b> (can run your life & business) .....	69.
<b>Focal Point II</b> (will run your life & business) .....	125.
<b>Icon Factory</b> (2000 icons plus editor) .....	35.
<b>HyperAnimator</b> (sync sound and animation) .....	115.
<b>HyperComposer</b> (create sound & music scripts) .....	45.
<b>HyperBible</b> (King James version on a stack) .....	150.
<b>HyperTutor</b> (stack teaching stack) .....	39.
<b>Reports!</b> (reports designer plus improved printing) .....	65.
<b>Script Expert</b> (HyperTalk in a stack) .....	49.
<b>Silver Screen</b> (movie database. oscars actors etc) .....	49.

### EDUCATIONAL

<b>Kids Time</b> (5 fun games for 3 to 7 year olds) .....	29.
<b>Mavis Beacon Teaches Typing</b> .....	24.
<b>Mastering the GMAT</b> (a must for MBA candidates) .....	45.
<b>The Manhole</b> (suitable from ages 4 - 84) .....	35.
<b>Puppy Love</b> (game for 3 to 5 years (Plus only)) .....	19.
<b>Reader Rabbit</b> (good reading trainer) .....	39.





**Talking Tiles** (reading training with voice) 69.  
**Where in the World is Carmen Sandiego?** (10+) 29.  
 Special very low Education prices are available on the following products to authorized educational establishments only with official purchase orders. If you are in doubt as to whether you qualify for discounts please call us before placing an order.

**MICROSOFT**  
**Excel, Word, Write, PowerPoint, File, QuickBASIC, CLARIS**  
**SmartForms Designer, MacProject, MacDraw II, MacPaint II, FileMaker II, MacWrite II**  
**OTHERS**

**Illustrator 88, ReadySetGo 4.5, Lightspeed G, Lightspeed Pascal, Nisus, Mathematica**  
 Five and Ten pack version also available on some products.

**Fonts**  
**Adobe Fonts** (full range at discount prices) call.  
**Blanco** (new display face includes grey versions) 59.  
**Fancy Fonts** (64 new versions of built in fonts) 59.  
**Fraction Fonts** (in Serif & Sans Serif faces) 59.  
**Fontastic Plus 2** (bitmap font creator/editor) 59.  
**Fontographer** (laser font creator/editor) 225.  
**Fluent Fonts** (2 excellent discs of bitmap fonts) 36.  
**Fluent Laser Fonts** (quality laser fonts) 59.  
**Keymaster** (turns PostScript into fonts) 59.  
**Monotype Fonts** (full range at discount prices) call.  
**World Class Fonts** (2 disc sets of good fonts) each 49.  
 "The Originals", "The Stylish", "The Giants" and now "LO and IISC Fonts (3 times size)"

**PC COMPATIBILITY**  
**AST 286** (AT Compatible board for Mac II) 975.  
**MacLink Plus** (port PC-Mac with codes) 145.  
**MacLink Plus Translators** (4 SE/30/1x range) 115.  
**Soft PC Mac OS** (PC emulation in software) 275.  
**Tops Flashcard** (LocalTalk Net card for PCs) 129.  
**Tops DOS** (PC software for TOPs network) 129.

**COMMUNICATIONS**  
**Pckt Stradcom Modem** (V21,22) 145.  
**Liaison** (access a desktop via modem) 169.  
**WS3000 Modem** (V21,22,23) 265.  
**Red Ryder 10** (the pro's choice) 70.  
**Timbuktu** (operate remote Macs) 75.  
**TOPS** (low cost and efficient networking) 145.  
**TOPS Flashbox** (Speed up LocalTalk 3 times) 125.  
**Vicom 3** (friendliest comms software) 155.

**MUSIC**  
**Concertware +** (8 voice composer, player) 49.  
**Concertware + MIDI** (new features) 99.  
**Jam Session** (play like a professional) 39.  
**MacDrums** (multiple drum synthesiser) 39.  
**Super Studio Session** (now works on Mac II) 89.

**TRAINING**  
**DTP Advisor** (tips and advice on layouts) 49.  
**PageMaker College** (tutorial lessons) 160.  
**Typing Tutor IV** (excellent way to learn) 39.  
**LearnWord 4** ..... each 39.  
 (4 modules for Microsoft Word) ..... all 4 for £140

**Learn FileMaker II** ..... each 39.  
 (4 modules for FileMaker II) ..... all 4 for £140  
**HyperEasy** ..... each 39.  
 (4 modules for Hypercard) ..... all 4 for £140  
**Excelerate** ..... each 29.  
 (8 modules for Microsoft Excel) ..... all 8 for £200  
**PageTutor** ..... each 39.  
 (4 modules for PageMaker) ..... all 4 for £140  
**Learn'88** ..... each 39.  
 (4 modules for Illustrator 88) ..... all 4 for £140  
**MacTeach** (specify Mac and if HD or floppy) ..... each 39.  
 (2 modules Macintosh training)

**HARD DRIVES**  
**miniQisk 20Mb** ..... 365.  
**miniQisk 45Mb** ..... 450.  
**miniQisk 70Mb** ..... 575.  
**miniQisk 100Mb** ..... 695.  
**Qisk 20Mb** ..... 425.  
**Qisk 45Mb** ..... 475.  
**Qisk 70Mb** ..... 595.  
**Qisk 100Mb** ..... 710.  
**Qisk 140Mb** ..... 825.  
**CMS Tape Backup 60Mb Tape Streamer** ..... 695.

**HARDWARE**  
**SIMMS** (2" 1Mb low profile) ..... 295.  
**MacPlus Mouse** (optical mouse, smooth-) ..... 60.  
**SE & II Mouse** (runner, never gets dirty) ..... 75.  
**MacRecorder** (brilliant audio digitiser) ..... 135.  
**Mac II Stand** (vertical floor stand with long cables) ..... 69.  
**Joystick MacPlus** (something you've...) ..... 45.  
**Joystick Mac SE or II** (always wanted) ..... 59.  
**Kurta Graphics Tablet** (precise Draw/CAD input) ..... 275.  
**Z88 MacLink** (port data from Z88 to Mac) ..... 51.  
**Toolkit** (open your Plus or SE safely) ..... 15.  
**Irwin 68000 16Mhz** (double Speed Mac SE) ..... 275.  
**Irwin 68020 16Mhz** (a Mac II in a SE) ..... 495.  
**Irwin 68020 20Mhz** (faster than a Mac II) ..... 625.  
**Irwin 68020 25Mhz** (even faster still) ..... 1100.  
**Cables** (ring us with your requirements) ..... call.  
**Anet** (AppleTalk set at half the price) ..... 25.

**SCANNING**  
**ScanMan** (hand held 4" wide 32 halftones) ..... 310.  
**ThunderScan** (amazing quality for low cost) ..... 189.  
 ThunderScan fits onto your ImageWriter I or II (not LO) instead of the ribbon and an infra red eye reads the page as it passes through the printer. Comes with software ready to run. The scan quality, effectively 200 dpi, is superb - comparable to expensive flatbed scanners. Mac II adaptor now available.  
**Read-It 2** (OCR software for most scanners) ..... 285.  
**Read-It Personal** (for ScanMan & ThunderScan) ..... 115.

**GAMES**  
**Ancient Art of War** (quality war simulation) ..... 29.  
**Ancient Art of War at Sea** (salty war simulation) ..... 29.  
**→Arkanoïd** (addictive game of Breakout) ..... 27.  
**Balance of Power** (Use strategy to keep peace) ..... 24.  
**→Balance of Power 1990** (Geopolitics, strategy) ..... 24.  
**ChessMaster 2000** (best Chess game) ..... 25.

**→Chuck Yeager Flight Trainer** (colour!) ..... 25.  
**→Crystal Quest 2** (Britain's favourite game) ..... 35.  
**→Crystal Quest with Critter Editor** ..... 55.  
**→Colony** (Best game 1988 MacWorld) ..... 29.  
**Deja Vu** (private dick adventure) ..... 24.  
**→Deja Vu II** (Lost in Las Vegas) ..... 24.  
**Fire Brigade** (the battle for Kiev 1943 - networks) ..... 29.  
**Flight Simulator** (the famous Microsoft one) ..... 35.  
**→Falcon 2** (interactive dogfighting) ..... 34.  
**Ferrari Grand Prix** (formula one simulation) ..... 36.  
**→Gauntlet** (colour arcade game) ..... 32.  
**→Harrier Strike II** (3D combat simulator) ..... 32.  
**Hitchhikers Guide to the Galaxy** (Adams' classic) ..... 15.  
**→Hunt For Red October** (sub simulation) ..... 32.  
**→Life and Death** (Perform actual operations in detail) ..... 24.  
**Leather Goddesses of Phobos** (raunchy adventre) ..... 15.  
**MacGolf** (superb graphics, highly realistic) ..... 35.  
**→MacGolf Colour** (.. and highly addictive) ..... 56.  
**MacCourses** (extra courses for MacGolf) ..... 21.  
**→Moeblis** (interactive adventure) ..... 25.  
**Patton vs Rommel** (strategy war game) ..... 19.  
**Pinball** (also includes construction kit) ..... 15.  
**→P51 Mustang** (fast & furious flying) ..... 32.  
**→PT 109** (patrol boat graphic simulation) ..... 29.  
**→QuarterStaff** (role playing with colour) ..... 29.  
**→Road Racer** (terrific high speed action) ..... 45.  
**→Reach For The Stars** (galactic war game) ..... 29.  
**Scrabble** (the old favourite) ..... 29.  
**Shanghai** (Chinese Mah Jong) ..... 25.  
**→Shufflepuck** (air table ice hockey) ..... 25.  
**Solitaire** (9 different patience games) ..... 24.  
**→Solitaire Colour** (beautiful graphics) ..... 29.  
**Sub Battle** (command a WWII submarine) ..... 29.  
**→Sub Battle Colour** (most realistic) ..... 29.  
**Tetris** (Soviet award winning game) ..... 24.  
**→Tetris Colour** (brain teasingly addictive) ..... 27.  
**→The Manhole** (suitable from ages 4 - 84) ..... 35.  
**→Universal Military Simulator** (3D wargame) ..... 35.  
**Where in the World is Carmen Sandiego?** (10+) ..... 29.  
**Wizardry** (graphic adventure) ..... 29.  
**→Zork 0** (classic adventure now in colour) ..... 39.

**→ Works with Mac II**  
 always check for compatibility as many games do not work on the new Macs

**BOOKS**  
**Apple Macintosh Book** ..... 19.  
**Inside Mac Vols 1, 2, 4, 5** ..... each 23.  
**Inside Mac Vol 3** ..... 19.  
**Macintosh Advisor** ..... 16.  
**Macintosh Bible 2nd Edition** ..... 26.  
**Macintosh Revealed Vols 1 & 2** ..... each 23.  
**Hypercard Handbook** ..... 27.  
**Hypercard Handbook upgrade** ..... 18.  
**Guide to Omnis 3** ..... 21.  
**Excel Advanced User Guide** ..... 17.  
**Using Excel** ..... 19.  
**Mastering Excel** ..... 22.  
**Excel: Using Macros** ..... 18.  
**Mastering Adobe Illustrator 88** ..... 21.  
**Using Aldus PageMaker 3.0** ..... 21.  
**Design for DTP** ..... 12.  
**Quark XPress Companion** ..... 12.  
**Microsoft Word Made Easy** ..... 16.  
**Word Perfect** ..... 20.  
**Works on the Mac** ..... 17.

**Policy**

- \*Credit cards will not be charged until the order is shipped.
- \*If a partial order is despatched, the balance is posted free of additional postage charges.
- \*All Goods are sent by Insured Registered First Class Mail.
- \*Courier services are available.
- \*Defective software is replaced immediately.
- \*Refunds will only be given on unopened packages that are returned within 7 days of receipt.
- \*Prices are correct at time of going to press.

**WE WILL MATCH ANY GENUINE PRICE OFFERED BY OUR COMPETITORS IN THIS ISSUE. CALL US BEFORE YOU BUY.**



**Ordering**

- \*To order call Monday - Friday, 9.30 to 5.30.
- \*Add £2.50 per order for Postage & Packaging (£7.00 on orders over £300 for Courier delivery)
- \*Add VAT to the total price, except on books.
- \*Payment is by credit card, cheque or money order.
- \*Government departments, Educational establishments, and PLC companies are welcome to purchase with an official order.
- \*International orders accepted with credit card only. Postage added at cost.

**MacLine 01 642 4242**  
 WREN HOUSE • SUTTON COURT ROAD • SUTTON • SURREY • SM1 4TL • FAX 643 6453 • VAT No 452 3149 66



# MacChat

## Norah Arnold looks at the latest Macintosh developments and product news.

### Right to Left Word Processing

I am hoping that there is a member out there somewhere who can help the writer of this letter with his problem.

Dear Editor,

In connection with my letter to you dated 11th March, I enclose an article which appeared today in *The Independent*. Its author refers at one point to writing from right to left and claims that it presents no major problem. He must be right, of course.

I have now found that on your Macintosh Library Disk No. 015, the Hebrew fonts have a DA device which reverses the order of printing but it does not work with other fonts. I hope that either you or one of your readers will be able to advise me how to change the direction of printing for Arabic fonts.

Yours sincerely,  
B. W. Andrejeski.

### Koala Source Book of Macintosh Software

Koala Publishing have written to us asking for information to go into their Koala Source Book of Macintosh Software. They point out the fact that the Koala Source Book of Macintosh Software will not now be unique, this being an indication of the speed at which the Macintosh market is developing. At the time they first started circulating information however, to the best of their knowledge there was no other similar publication. One alternative that now presents itself is International Magazines' Macintosh Directory at £24.95.

Koala Publishing's Source Book has an accessible price of £9.95 which means that it may well be purchased by many people inter-

ested in Macintosh software.

The anticipated publication date for the Source Book will be August 1989 so anyone who wants details about products to be published in it should contact Koala Publishing, Unit 28, Avon Business Park, Lodge Causeway, Fishponds, Bristol BS 16 3JP, England.

Tel: (0272) 584234.

### Omnis 5

Blyth Software have announced the new database and management system for Macintosh and IBM compatible personal computers, Omnis 5. This is a relational and/or hierarchical database program which has been specifically designed to fully utilise the graphical interface, enhanced memory storage and colour capabilities of both Macintosh and IBM PS/2 hardware.

Omnis 5 for the Macintosh will be released in the UK, the United States and Europe in May 1989. Omnis 5 will retail at £595.00 with add-on user packs available at £145.00 each. Versions of Omnis 5 for both DOS and OS/2 platforms will be released by Blyth later in 1989.

The following information about Omnis 5 has been supplied by Blyth Software.

Omnis 5 is a comprehensive program for developing business data management applications. It is immediately usable by the novice, who can start with simple applications requiring little or no programming skills and gradually mould them into complete business management systems as their skill with the program develops and their needs expand.

For the professional developer and reseller of business applications, Omnis 5 offers a complete

development system including runtime options and multi-user support, together with the programming power and flexibility needed to build large data management systems, eg. data files can be up to 2560 megabytes, application (design) files can be up to 32 megabytes in size and there is no limit on the number of records in a data file (up to maximum data file size).

Omnis 5 is particularly suitable for developing totally "Mac-like" applications. The "event manager" allows the user to have complete "point and click" control over multiple open windows in a finished application, all with multiple fonts, colours and graphics.

Omnis 5 (Macintosh) applications and data can be shared with IBM PS/2s on a mixed network using DOS and OS/2 versions of Omnis 5.

Some of the key features of Omnis 5 include:-

- Full colour graphics can be included in the window design or stored in the data file.

- Text data can be displayed in any font and colour.

- A graphic can include "hot areas" for HyperCard-like buttons.

- Data from different files can be displayed on any window.

- User-defined menus can be substituted for the "standard" menus.

- Full support for graphics data.
- Pushbutton, radio box, check box field types.

- WYSIWYG reports.

- Total flexibility with more than 200 programming commands.

- Variable-length records for efficient use of disk space.

Included with the Omnis 5 program is Blyth's "fast start" program, Omnis 5 Express, useful for novice, intermediate and advanced Omnis users. Beginners can use Omnis 5 Express to help them with their first applications, whilst more experienced users can use it for simple databases and fast prototyping of more involved systems.

Omnis 5 also includes HyperCard access - a set of programs called XCMDs that will allow HyperCard stacks to read Omnis 5 data files, in both single and multi-user installations. Omnis 5 requires MacPlus or greater. 🍏





# AnonWare

## Hypercard games in Mac Library.

### Dingbats

In Dingbats play commences when the first player clicks on the 'DIE' button. As the game makes clear, this is in fact one dice, not an instruction to cease living! Once the die has shown a new number, player 1 will be advanced by that number of squares. The fun starts when the player lands on a question square. The type of design on the question square denotes the type of question the player is asked. Some questions are 'easy' and the player has 30 seconds in which to answer, while some are 'hard' and 60 seconds are allowed. Sometimes the question can be answered by any player.

### Boggle

The object of the game is to list, within the time limit, as many words as you can find among the assortment of letters in the square grid. Each Boggle player must have a pencil and paper. Then the game is started by clicking on the "New Grid" button in order to set a new grid of letters. The the timer will automatically begin counting down. When the timer has started, each player searches the grid of letters for words of three letters or more. Words are formed from adjoining letters in the proper sequence. They may join horizontally, vertically or diagonally; to the left, right or up or down. No letter, however may be used more than once within a single word. Instructions are given for scoring and for the types of words allowed.

### Hi-Lo

This is the well known guessing game in a new form. The object is to guess Mac's number before he guesses yours.

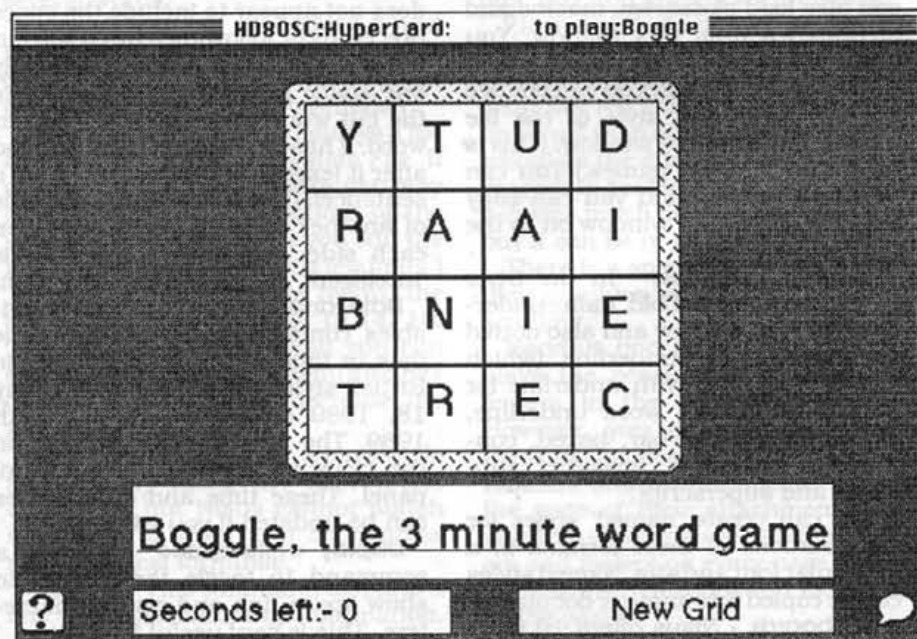
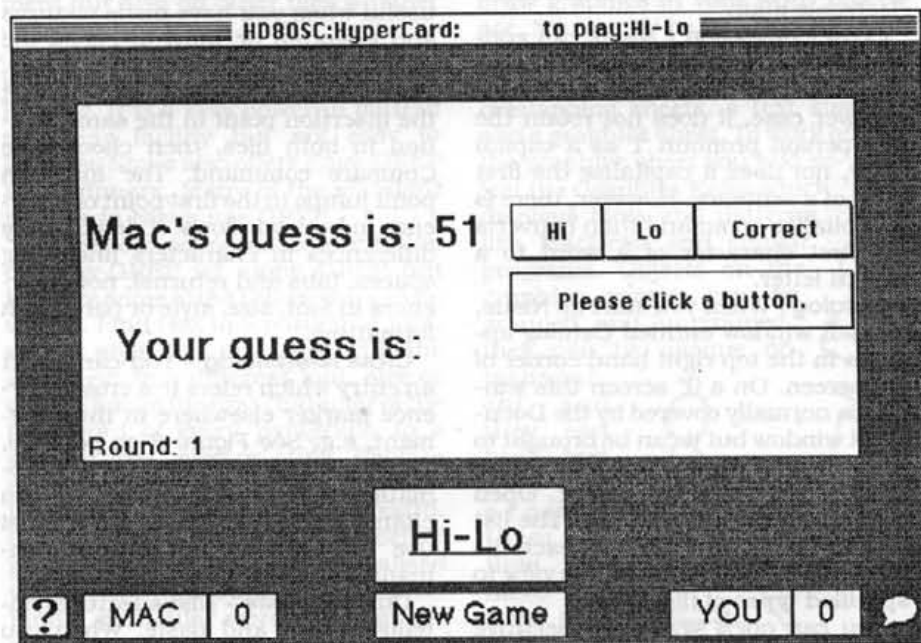

# Nisus

## Geoff Wood reports on a new Word Processor for the Macintosh, from Paragon Concepts

The battle for the title of best word processor for the Macintosh has brought another contender to the scene. Nisus, from a small company called Paragon Concepts, is a word processor with some powerful features but some vital shortcomings. I can't see it ousting Word and MacWrite because they have much bigger budgets for promotion. This is a pity because Nisus has some superb features that other word processors lack.

For example, it offers 10 different Clipboards to store text or graphics. It retains more than the last 'undo' or 'redo' operation - up to 32,767 of them. It can find and replace text in any specified font and format in open or closed files. It can detect unmatched quotation marks and parentheses. It offers not only a count of the number of words but also of the number of characters, lines, sentences, paragraphs and pages. It has tools for drawing object graphics. It offers powerful macro commands. It can save a file on two different discs automatically. And it can print an A5 booklet on A4 paper with the correct pages side by side.

However, Nisus 1.01 can't do footnotes, paragraph numbers, calculations, scientific formulae, outlining or hyphenation and it can't vary the number of columns within a document. An update file that comes with the program states that the next version will offer footnotes and other features and it will be free to registered users.

When I reviewed WordPerfect for the Macintosh (Apple 2000, April 1989) I pointed out that there is no such thing as the perfect word processing program because different people have different needs. This review covers the main commands and features of Nisus in alphabetical order. You can then decide whether its features suit your needs.

**ASCII characters** - This command displays a narrow window listing all the ASCII characters in sequence. You can then cut and paste characters that are not available with the

Option and Command keys.

**Break wrapped lines** - This unusual command inserts a return character at the end of every wrapped line of a selected paragraph so that each line becomes a paragraph. This can be useful for editing or for transmitting electronic mail.

**Case Conversion** - Nisus can convert selected text from upper to lower case and vice versa. When it converts to lower case, it does not retain the first person pronoun 'I' as a capital letter, nor does it capitalise the first word of a sentence. However, there is a Capitalise command that converts the first character of a word to a capital letter.

**Catalog** - When you start up Nisus, a small window entitled Catalog appears in the top right hand corner of the screen. On a 9" screen this window is normally covered by the Document window but it can be brought to the front. The window lists all the files in the current folder or disc. Open files are indicated by a tick. The list shows not only the name of each file but its type. You can limit the view to specified types of files.

You can open several consecutive files from the Catalog window. You can also load glossaries, macros and dictionaries from this window. You can use the Find/Replace command to find a file in the list. You can change the font, size and style of the file names in the Catalog window. (This is useful for long file names.) You can print the Catalog and you can copy the contents of the window on to the Clipboard.

**Character Formats** - In the Style menu, Nisus offers bold, italic, underline, outline, shadow and also dotted underline, lower underline (which can be combined with underline for double underline), word underline, strikethrough, overbar, boxed, condensed, expanded, invisible, subscript and superscript.

You can create 'named' styles for combinations of these formats in a particular font and size. Named styles can be copied into another document.

**Clipboards** - Nisus offers 10 Clip-

boards, only one of which can be current. When you cut, copy or paste, Nisus uses the current Clipboard. If you want to retain the contents of that Clipboard, you can switch to another Clipboard by using a command in the Edit menu. You can edit and/or print the contents of the current Clipboard.

**Columns** - Nisus can print up to 8 columns on a page but it can't change the number of columns part way through a document. It does snaking columns, where the text carries over from the bottom of one column to the top of the next. It does not do side-by-side columns, where blocks of text in each column are aligned horizontally.

The columns must be evenly spaced and you can only display the multiple columns in Page Preview mode. Text can be edited only in the Document window but you can have both windows open on the screen.

**Comparing text** - Nisus can compare two files automatically. This is useful when you have made changes and forgotten or want to check the changes. You just open the two files, place the windows side by side, put the insertion point in the same location in both files, then choose the Compare command. The insertion point jumps to the first point of difference in both windows. It detects only differences in characters (including spaces, tabs and returns), not differences in font, size, style or paragraph formatting.

**Cross referencing** - You can insert an entry which refers to a cross reference marker elsewhere in the document, e.g. *See Figure 3 on page 28*. The page number is updated automatically if necessary, but if you change *Figure 3* to *Figure 4*, you must use the Update X-Reference command.

**Cut and paste** - Nisus features 'intelligent' cut and paste. When you double click on a word, the selection does not appear to include the space preceding or following it but if you cut the selected word, Nisus leaves only one space behind. When you paste the cut word before or after another word, it has only one space before and after it (except at the start or end of a sentence). If you paste it in the middle of another word, it has a space on each side. You can switch off this 'intelligent' cut and paste if you wish.

**Date and Time** - The Insert Variables command lets you insert the date or time. Dates are displayed in British styles - 18/5/89 or Thu, May 18, 1989 or Thursday, May 18th 1989. The time display depends on the clock in the Macintosh control panel. These time and date entries can be updated if you wish.

**Display white space** - There is a command to toggle the display to show space, tab and return characters. This is very useful for editing.



**End of Document** - There is no visible indication of the end of the document. With Word 3, you can see if there are blank lines after the last paragraph because there is a short horizontal bar at the end of a document. With Nisus, you must test with the down arrow key or display white space and look for return symbols.

**Finding and Replacing** - Nisus can search forwards or backwards to find text or character graphics. If the search starts part way through a document, you can opt to continue from the end (or beginning) until it reaches the insertion point. You can enter a search word or a replacement word in any font, format or size. You can specify whether to search for whole or partial words and whether to search for a case sensitive match or an exact match for font, format or size.

The Find/Replace command can operate not only on the active document but also on other files whether open or closed.

Nisus also offers GREP which stands for Global Regular Expression Parsing. It is a very powerful pattern matching facility but not easy to learn, so Nisus also offers Easy-GREP for beginners. Many of the standard macros in Nisus use GREP.

Space does not permit a description of Easy-GREP let alone GREP but here are some of the things you can do with it. Find text in a particular font, size or style and replace it with the same text in a different font, size or style. Change the first character of the first word of every paragraph to a specific font, size or style. Replace every underlined word with the contents of a designated Clipboard. Check your document for correct punctuation. Find all capitalised words not at the start of a sentence. Find a particular word if it is at the start of a sentence. Find any one of several words.

**Files** - Nisus can read Word 3 and MacWrite files (and a MacWrite Clipboard). It also offers a special program for importing files into Pagemaker.

**Fonts** - The Font menu displays a list of all the fonts in your System File. If you have more than 18 fonts, you may have to scroll off the bottom of the screen. (Word 3 and 4 let you edit the Font menu to display just a few fonts.)

**Font Sizes** - In the Size menu, the standard sizes are 9, 10, 12, 14, 18, 24, 28, 36, 48 and 72 but you can specify other sizes. The menu also has options to increase or decrease the font size by one point.

**Formulae** - You can type simple formulae by using the appropriate characters but Nisus cannot match the ability of Word 3 to do complex mathematical formulae.

**Get Info** - This command displays a box with the following information.

Disc name, folder name, name of active document, date and time created and modified, size in bytes, number of characters, number of words, average word length, number of sentences, average word per sentence, maximum words per sentence, number of lines, number of paragraphs, number of pages, Flesch reading ease and reading grade level. If more than one document is open, the display also shows the last 11 items for the sum total of all the open documents.

**Glossary** - Nisus offers glossary facilities to save typing long words or phrases. You can create a glossary by specifying an abbreviation for each long word or phrase. Having typed an abbreviation in your text, you can expand it immediately or later. You can create several glossaries for different purposes and you can copy entries from one glossary to another.

**Graphics** - If you need to be able to draw graphics in your word processor, Nisus may be a better buy than Fullwrite Professional. In effect, the Nisus window has two transparent overlapping sheets, a text sheet and a graphics sheet. To work on the graphics sheet you just select the Graphics Ruler which displays tools and patterns like MacDraw and similar programs. Objects on the graphics screen can be grouped and ungrouped, they can be opaque or transparent and they can have text wrapped around them or flow behind. It is very easy to combine text and graphics with Nisus.

Bit-mapped graphics can be imported from MacPaint or similar programs. Once in Nisus they can be re-sized but not edited. Object graphics imported from other programs can be edited on the graphics sheet. When a graphic is pasted on the text sheet it behaves much like a single character but it can be re-sized and cropped.

There is a special command to display graphics as XXX to speed up scrolling.

**Headers and Footers** - Nisus displays the contents of headers and footers in the Document window. However, you must create or edit them in the Header/Footer window. Headers and footers appear first on the page of their attachment paragraph so you can have different headers and footers on every page (except for odd/even headers and footers on facing pages).

There is an option to display a small icon in the left hand margin to indicate whether a document has headers and/or footers and, if so, whether they are odd/even.

**Hyphenation** - Nisus does not offer hyphenation. This is a serious short-coming in a word processor which has so many other powerful features.

**Index** - See Table of Contents below.

**Information Bar** - An Information Bar is displayed above the Ruler, but it can be suppressed. If the document has been changed since the last save, the Information Bar displays a pencil icon. It also shows the page number of the text currently displayed and, if the document has multiple columns, it shows the column number.

The Information Bar also shows the position of the insertion point as a pair of numbers. The first number is the character count from the start of the paragraph in which the insertion point is located. The second is the line number from the beginning of the page. You can change the second number to show the number of characters from the beginning of the document. Alternatively, the two numbers can be the distance from the left of the page and the distance from the top of the page.

**Jump** - This command moves the insertion point to a specified page or line or to the end of the document or to a marker previously inserted in the text. You can

set as many markers as you like in a document, each with a different name. Marker names are listed in

the Search menu and you can select a name to move the insertion point to it.

**Keep on Same Page** - This command prevents a paragraph or several paragraphs from splitting at the bottom of a page. This is very useful for tables.

**Kerning** - Nisus does not do kerning but it does offer condensed text format.

**Keyboard Commands** - Nisus has keyboard commands for many but not all of the menu commands. Most of the keyboard commands are shown in the menus but you can remove them or change them if you wish. Most dialogue boxes display keyboard shortcuts when you press the Command key.

**Ligatures** - Nisus has macros for ligatures of fi and fl. The manual says that the macro works on all PostScript fonts but for me it worked only on Times and Palatino.

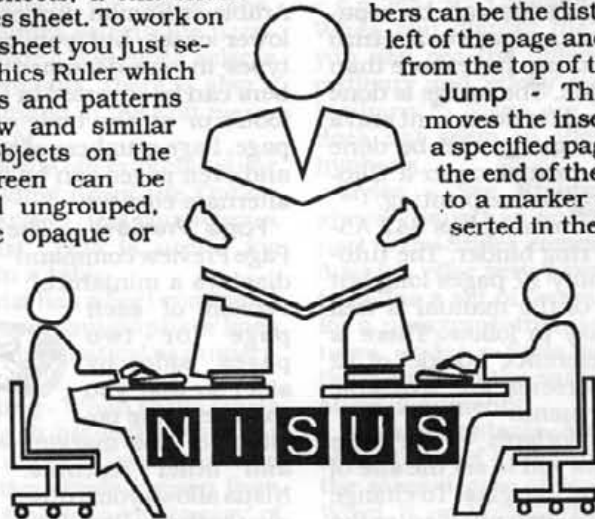

**Line Numbers** - Nisus can number the lines of a document either from the top of each page or from the beginning of the document. You can number every line or every nth line and you can specify the font, size and style of the line numbers.

**Line Spacing** - A line in Nisus is defined as 12 points, so if you are not using 12 point font size, when you choose double spacing from the icon in the Ruler, you may not get the effect you want. However, you can define the line spacing of any paragraph in terms of the number of points (but not less than the font size).

**Macros** - Nisus offers macros to record menu selections, keystrokes and mouse clicks (but not drags). You can create a macro to perform almost any series of operations.

Nisus comes with a file of 87 ready made macros whose names appear alphabetically in the Tools menu. You can add to this file or create other macro files. However, only one macro file can be active.

**Mail Merge** - Nisus offers a special macro for mail merge. However, it only does simple merging, not conditional merging. Fields can be separated by a comma, a space or a return character so you can have more than one field on a line. The merge is done from two files, a data document and a form letter. The merge can be done straight to the printer or to a Clipboard for editing before printing.

**Manual** - The manual has 347 A5-size pages in a ring binder. The tutorial section is only 17 pages long but the remainder of the manual is well set out and easy to follow. There is also a 'quick reference' booklet of 12 pages. Help screens are available from the Apple menu.

**Margins and Indents** - The Page Setup box allows you to set the size of paper but not the margins. To change the page margins, you must enter the Page Preview mode (see Page Preview and Ruler below).

If you specify Facing Pages, you can have a 'gutter' in left and right margins of the right and left pages respectively.

**Matching quotes and parentheses** - Nisus has a special feature to check for unmatched quotes and parentheses. When you type an opening quote or parenthesis, the Information Bar can display the opening character until you type the corresponding closing character. There is also a command to detect unmatched quotes and parentheses in text already typed. This feature is useful not just for quotation marks but for parentheses in mathematical formulae.

**Memory** - Nisus needs 1Mb of ram or 2Mb with MultiFinder. It can be run from two 800k discs but needs some disc swapping if the spell checker and thesaurus are used. The

whole document is kept in memory to there is a limit to the size of file and the number of documents open. If memory runs low, one or more documents may 'black out' but they can be restored to normal.

**Menus** - The main menu normally shows seven words, namely, File, Edit, Search, Tools, Font, Size and Style but when you use some commands (e.g., Page Preview) another command is added to the main menu. In the main menu, many of the commands have sub-menus that pop out sideways, some on the left, some on the right. Pop out menus seem to slow things down even though it takes less than a second to move the mouse sideways.

**Numbering Paragraphs** - Nisus does not automatically number paragraphs.

**Outlining** - Nisus does not do outlining.

**Page Breaks and Pagination** - Page breaks are inserted automatically as you type but you can insert a forced page break. You can switch off the pagination if you wish.

**Page Numbering** - You can specify Arabic or Roman numerals (upper or lower case), but you can't mix the types in one document. Page numbers can be inserted in the header or footer or on the body of the page. Page numbers of odd and even pages can be in alternate corners.

**Page Preview** - The Page Preview command displays a miniature version of each page (or two pages side by side) so that you can check the position of the margins and other features. Nisus allows you to display both the Page Preview and the Document window on the same screen. Thus you can edit text in the Document window and instantly see the effect in the Page Preview window.

The Page Preview window has a vertical scroll bar to allow you to move through the document. Above the scroll bar are icons to switch to the Document window or to show the two windows side by side. There is also a magnifying glass icon but this does not inflate the Page Preview window; it simply switches the display to the corresponding place in the Document window. On a large screen you could zoom the Page Preview window to show a full size view.

Across the top of the Page Preview window is an Icon Bar which can be

toggled on or off. This bar has icons to toggle from single to double page view and to switch to a 'two-up' view (see Two-up, below).

The Icon Bar lists the dimensions of the paper and the width of the margins and the width and height of the text. You can adjust the margins by dragging the dotted lines which mark the margin positions in the Page Preview window.

The Icon Bar also has icons to centre the text on the page, to expand the margins, to invoke the Page Setup dialogue box and to print the document.

**Page Preview Commands** - When the Page Preview window is displayed, the main Menu Bar also displays the word Preview which provides access to various commands. These include Center Page and Expand Margins (equivalent to the icons in the Icon Bar) and Set Margins. The latter brings up a dialogue box that allows you to specify the width of the margins and to specify the number of columns and the gutter between columns.

The other commands under Preview are Options, Frame and Columns. The Options command invokes a dialogue box that lets you specify whether to display the margins, whether to align them to a 1/8" grid, whether to centre the text horizontally and/or vertically, whether (with facing pages) to mirror the margins horizontally or vertically and whether to show the first page on the left (or top) or on the right (or bottom).

The Frame command invokes a dialogue box that lets you specify a frame round all the text on each page. There are four standard frames, i.e., single or double line with square or rounded corners but you can also design your own frame.

The Column command invokes a dialogue box to specify the number of columns, the gutter between columns and whether to have a vertical line between columns. You can choose from 6 different widths for the line.

**Page Setup** - The Page Setup command displays a standard Macintosh dialogue box with an extra panel which allows you to specify a custom paper size and other details.

**Preferences** - Nisus can be customised in many ways. The Preferences command allows you to specify information about startup, new files, saving, editing, searching, scrolling, measurements, printing, parentheses, dictionaries and menu keys. In





any document, you can also customise the display of dates and times and line numbers.

**Printing** - Nisus uses the Macintosh System dialog box with some extra options such as print pages last to first, update cross references and update time and date.

**Remove leading and trailing blanks** - There are options in the Preferences command to automatically remove unnecessary spaces from the beginning and/or end of a paragraph when you press the Return key.

**Rulers** - You can display or suppress the Master Ruler at the top of the screen. It is graduated in inches or centimetres and it shows the positions of the left and right margin markers, the first line indent marker and tabs. You can drag the markers to any desired position but not outside the text width.

The widths of the left and right margins as determined by the Page Setup are indicated by shaded areas in the Master Ruler.

The Master Ruler displays three icons which offer pull down menus. The first icon changes the line spacing from single to 1.5, double, triple or other. The second icon changes the spacing above the first line of a paragraph from nil to 1.5, double, triple or other. The third icon changes the text alignment from left to right or centre or justified both sides.

The formatting specified in the Master Ruler applies to the whole document unless you insert another ruler. Unlike MacWrite, Nisus does not display a whole new ruler. Instead, it displays a small ruler icon in the left hand margin near the first line of the paragraph. If you change the formatting of an existing paragraph, Nisus assumes that you want the ruler to apply only to that paragraph and it inserts a Protective Ruler at the end of the paragraph to resume the previous formatting. Like Word 3, the Master Ruler shows the formatting of the paragraph which contains the insertion point.

You can copy and paste the small ruler icons. This is an easy way to change the formatting of a paragraph to match that of another paragraph.

The Master Ruler has an icon for toggling the display of the small ruler icons and another icon for toggling display of the header/footer icons in the left hand margin.

If the Graphics Ruler is selected, the Master Ruler is suppressed and vice versa.

**Saving a File** - When you first save a file or use Save As, you can specify three formats, namely, Nisus Document, Nisus Stationery (see below) or Text Only.

Nisus can save a file automatically after a specified number of keystrokes. It can create a backup file in

the sense of retaining the previous version of the file. It can also save a file on two different discs or in two different folders automatically.

There is a useful option in the Save As dialog box called Change Name, Don't Save.

**Scroll Bars** - Nisus has vertical and horizontal scroll bars. You can suppress the horizontal scroll bar to display more text. Just above the vertical scroll bar at four small icons to display or suppress the Information Bar, the Master Ruler, the Graphics Ruler and the Page Preview window.

Nisus also has both vertical and horizontal Split Bars so you can have two or four views within a document. Double clicking on a split bar closes the split.

**Scrolling** - When you click in a scroll bar arrow, the screen moves one line at a time but if you hold the mouse button down the scrolling speed increases. You can change the speed of this fast scrolling.

**Selecting Text** - Clicking twice with the insertion point located anywhere in a word selects the word. Clicking three times selects the whole line. Clicking four times selects the paragraph and clicking five times selects the whole document. There is also a Select All command in the Edit menu (or Command-A).

**Like Word**, Nisus offers 'rectangular selection'. Holding down the Option key before dragging, lets you select a column of text. This is useful for moving data in a table.

**Sorting** - Nisus has a Sort command so it is easy to sort paragraphs or lines in a table into alphabetical or numerical order.

**Spell Checking** - When Nisus starts spell checking, it highlights the first suspect word and displays a list of up to 16 alternative words chosen from its British or American 'dictionary' of 80,000 words. You can select the correct spelling (or type it in yourself)

and click on the Replace button or on the Replace All button. Alternatively, you can click on the Skip button or on the Skip All button.

The spell checker also detects repeated words like 'the the' and sentences that start with a lower case letter. You can't edit the main dictionary but you can build up your own dictionary of words such as Desktop, Clipboard, spreadsheet, etc.

**Stationery Files** - A stationery file is a template document such as a letterhead, an envelope or a report format. A stationery file can contain text and graphics or it can be an empty file with special settings in the Master Ruler.

When you open a stationery file, it appears as an untitled document. This means that you can save it under any name without destroying the original file. Indeed, when you choose New from the File menu, Nisus looks for a stationery file called Nisus New File. You can modify this stationery file to suit your own needs.

**Sticky Spaces** - You can have non-breaking spaces to prevent two or more words being split on to two lines - e.g. Mr R Cholmondley-Smythe. When you display the white space, you can see the difference between ordinary and 'sticky' spaces. Normal hyphens in Nisus are 'sticky' and it does not seem to offer 'non-sticky' hyphens.

**Styles** - See Character Formats above. Nisus has no direct counterpart to the Styles commands in Word 3 which offer very powerful facilities to define a set of formatting features for a paragraph then save those features under a Style name and use them again in the same document or other documents.

**Table of Contents** - Nisus can generate a Table of Contents but not with the same degree of sophistication as Word 3 or WordPerfect. You must select each word or phrase that you want to appear in the Table of

File Edit Search Tools Font Size Style

Paragon nwsitr 2

320/28 D1

L 1 9 1

11 12 13 14 15 16 17

**NEW PRODUCTS**

Nisus, The *Amazing Word Processor For Your Macintosh*, has shipped!! Nisus is the answer to people's discontent with word processors. Among its most notable features are multiple editable clipboards, graphics drawn in text mode, GREP find and replace, record or write macros, unlimited undos, and automatic indexing. Some even predict that people will buy Macintoshes just so they can use Nisus.

N I S U S

PARAGON concepts, inc.

Contents, then choose the Contents Selection command. Such entries are surrounded by a dotted box which can be suppressed for printing.

After selecting and marking all the entries, you choose the Make Contents command. The Table of Contents is created in a new window entitled Filename Contents. It must be saved as a separate document. The Table of Contents shows the page numbers with tab leaders but Nisus offers only one level of entry whereas Word offers up to 9 levels.

An index can be created in much the same way. You can mark the entries as you go along or use Find/Replace to search the document and index the entries automatically. There is an Index As command for grouped entries - e.g. dogs, cats and canaries could be indexed under the word pets. The index should not be created until after all editing is completed, otherwise the page numbers may be wrong. The index can be formatted in various ways - e.g. one or more columns, comma after entry, blank line between sections, page number following entry, or right-justified with or without tab leaders.

**Tabs** - A new document in Nisus does not normally have preset tabs but you can set them if you wish. There are four types of tab marker - left-align, right-align, centre and decimal tab. To set a tab, you must drag the tab icon to the correct position on the ruler. After setting one tab, you must drag the icon again to set another.

You can move existing tabs by dragging them. To delete tabs you must drag them off the Ruler one by one. There is no command to delete all the tabs.

Nisus offers tab leaders - i.e. a row of dots, dashes or underline characters from the end of the text to the next tab position. This is useful for tables, especially a Table of Contents. You can specify any character you wish in a tab leader.

**Thesaurus** - Nisus offers both a British Thesaurus and an American Thesaurus to find synonyms. You select a word in your text, then choose Thesaurus from the Tools menu. The screen displays a scrollable window with a definition of the selected word and grouped lists of alternative words. You can select one of these words and click on the Replace button or on the Lookup button to search for more alternatives.

**Two-up** - The 'two-up' view (see Page Preview, above) is for creating booklets in which, say, two A5 pages are printed side by side (or one vertically above the other) on a sheet of A4. The pages are printed so that they can be assembled into a book without separating them. For example, in an 8 page booklet, pages 8 and 1 are

# Ansys

Expertise

printed side by side, then pages 2 and 7, 6 and 3, 4 and 5. The Page Preview window shows the half-size pages in the correct ordinal sequence for checking the continuity of the text.

**Undo and Redo** - When you make changes to your text, Nisus stores all the changes in an 'Undo List' which is preset to remember up to 300 changes. You can increase this number up to 32,767 but it will absorb more memory. The Undo command in the Edit menu (Command-Z) shows the nature of the change (e.g., font size) and the ordinal number of the change. After an Undo, the Edit menu offers a Redo command (Command-Z) showing the nature of the change and the ordinal number.

You can only Undo or Redo the changes in sequence. Nevertheless, you can go back through the sequence to reverse all the changes until you find the one you want, then go forward again. However, if you change one of the earlier changes on the Undo List, any changes with higher ordinal numbers are dropped from the Undo List.

If you are working on several documents, the changes you make to all of them are held in the same Undo List. This means that you may not be able to undo changes to another document without first undoing changes in the current document. When you close a document, the changes made to it are removed from the Undo List.

**Vertical Lines and Borders for Tables** - The easiest way is to use Graphics.

**Widows and Orphans** - Nisus can prevent widows and orphans (a single line of a multi-line paragraph appearing at the bottom or top of a page) but it is not a default. You must use a macro from the Nisus macro file.

**Windows** - The Window command enables you to manipulate the windows - e.g. send the top window to the back, toggle the top two windows, 'stack' the windows so that all the title bars are displayed one above the other, or 'tile' the windows so that up to 16 of them are displayed on the screen like tiles on a wall.

When you are viewing two windows



you can opt to have synchronised scrolling. If you have two screens, you can have different windows open on each of them.

**Zap gremlins** - This command deletes unusual characters that may appear in text imported from other word processors. They are characters that have been produced by using the Option or Control keys and they are usually displayed as a small rectangle.

info

Product : Nisus  
Publisher : Paragon Concepts  
Available from :  
Ansys Expertise Ltd  
(051 652 0909)  
or Apple Dealers

Price : £275 + VAT  
(Educational discounts avail.)

Value : ★★★★★  
Performance : ★★★★★  
Documentation : ★★★★★



# PostScript Fonts from the UK



Irene Flaxman checks out some special fonts from Lexitrope Ltd

We are always keen to encourage UK developers of software and hardware, and one such developer is Lexitrope Ltd, who have introduced some new PostScript fonts to the market.

These are not standard fonts, but are designed to meet very specific needs.

The first is a set of FractionFonts, plain and italic, allowing a wide range of fractions to be created - any combination of numerators from 0 to 100 with denominators from 0 to 100 (even though a mathematician may be horrified by some of the possible combinations!). The fractions are produced by typing the character for the numerator, then typing the character for the denominator - the particular combination of keys typed will determine the numbers used in the fractions, and a chart of all characters is presented at the back of the manual.

The fractions are designed to print clearly, even at small font sizes - e.g.

at 12 point normal font size, the numerator and denominator will be about 5 points only. The division line will always be proportional to the wider of the numerator or denominator, and the two figures will automatically be centred.

Two sets of BorderFonts are available, to enhance your presentations. They vary from the traditional styles, such as Greek and Victorian tiles; to the more modern styles, such as contemporary and tyre tracks; and some which are decidedly "fun" styles, such as cricket and kites. There are eight elements to any border - top, bottom, left side, right side, top left corner, top right corner, bottom left corner and bottom right corner. These fonts generally use two of the letter or numeric keys, with combinations of the shift and option keys to provide each of the eight elements. It takes a little practice but it is an easy system, once mastered.

The font size is selected in the normal way. Spacing is all-important, and leading must be set equal to font size to ensure that the characters will line up correctly to give a perfect frame.

These are PostScript fonts, so they will reproduce correctly on any PostScript-compatible printer - but the higher-resolution printers will be neater than the LaserWriter. The samples on this page and the cover were produced on a LaserWriter Plus.

Each BorderFont disk also includes an set of outline characters in an Adobe Illustrator file, which can be used to create borders of any size assuming that you have the Illustrator program, of course.

A new disk is to be released soon. This will be a "gizmos" font, providing lots of useful symbols as a PostScript font - including logos, such as Access and VISA; and commonly-used symbols, such as a knife & fork, teacup and information sign. We understand that this, too, will include outline characters in Illustrator format.

The FractionFont retails at £95 + VAT; the BorderFonts retail at £65 + VAT (each); the gizmos font should be available mid-June, at £85 + VAT. A discount is offered to registered users of the Lexitrope fonts when purchasing further fonts. They can be purchased from your local Apple dealer, or directly from:- Lexitrope Ltd, 3 Chatsworth House, 8 Abbey Road, Malvern, WR14 3HG.

## Apple tries to infiltrate the corporate market with Desktop Presentations technology

$$\frac{2}{75} \quad \frac{1}{33}$$



## Koala Reference Guide for the Mac

Apple Computers are still endeavouring to penetrate the corporate market, but with little success to date. This may be due in part to the attitudes of the decision-making executives - to quote a well-known phrase "No-one was sacked for buying IBM".

This is not the only reason, though - Apple have certainly missed some golden opportunities in the past.

Desktop Publishing was a strong selling point for the Macintosh and the LaserWriter - and, in my opinion, Apple failed to take full advantage of this when they had a monopoly situation.

A new market is emerging - that of Desktop Presentations. Apple see this as an important new arena, as evidenced by their recent drive to interest corporate users in seminars presented by the Apple dealership chain. Undoubtedly, they are trying to attack the market this time - but they

are still making mistakes.

The first is the letter used to entice the potential customers to attend a seminar. The letter emphasizes the importance of good presentations - but it is so full of grammatical errors as to be an embarrassment to the company (and to the dealers who are expected to distribute copies to their customers).

The second is the choice of presenters - from my limited experience, most Apple dealers are unwilling to invest in presentation or training skills so it is difficult to imagine that they would impress (my apologies to the more serious Apple dealers, of which there are some - but most seem to feel that they can just shift boxes).

We wish Apple well in their attempts to infiltrate the corporate market - but we do feel that their lack of professionalism will hinder them in their attempts.

Koala Publishing Ltd are planning to publish The Koala Source Book of Macintosh Software, a new reference guide for Macintosh users.

The anticipated publication date is August 1989, with an expected retail price of £9.95.

The Koala Source Book of Macintosh Software will include details of all types of software for the Mac, Apple dealers, and user groups.

Anyone wishing to have details of their products included in the guide should contact Koala Publishing Ltd as soon as possible, at the following address:- Unit 28, Avon Business Park, Lodge Causeway, Fishponds, Bristol, BS16 3JP.

# The Care and Feeding of Your Laser Printer

How to look after your laser printer, written by Walter Vose Jeffries. Article and artwork is © 1988, 1989.

Laser printers have become an integral part of many computer user's lives. They typically perform flawlessly, printing crisp copy day after day with nary a thought to maintenance or cleaning by their users. But, a day without your laser printer, when you need to print that critical report, is like a day without sunshine.

Laser printers are low maintenance machines but they can get quite dirty from paper dust and spilled

toner as well as from dust in the environment. A clean machine will produce better output and remain trouble free longer and it is relatively simple to clean.

First a quick introduction is in order. The diagram (see figure 1) shows some of the key components of the laser printer. Let's start by opening your machine by gently but firmly pulling up on the release lever as shown by the black arrow.

Let's jump into the most critical part of the cleaning process. With the printer lid open look inside above where the cartridge handle is normally located in the upper part of the printer. There are two filters here that often become clogged resulting in the machine overheating. This can cause blurred letters and graph-

ics on your printed copy. It can be gently cleaned with a vacuum or a cloth.

Find the silvery coloured rectangular well in the centre of the machine. It is crisscrossed by very fine wires. These are the printer corona wires and the well. Use a cotton swab lightly dampened with alcohol to gently wipe each of the wires (see figure 2).

The transfer wire

like drips of paint, on your printed copy. In this case you should also clean the corona wires in the cartridge (see the section below).

**Caution:** do not clean the printer corona wires with the cartridge corona wire cleaner. This will dirty the tool excessively, and undo its intended usefulness. Once it is dirty it will only make the cartridge corona wires dirtier. When used for its proper purpose it doesn't get very dirty.

If a large amount of toner builds up in the well a vacuum cleaner is the best way to get it out. Again, careful with the fragile wires.

Wipe the transfer guide with a barely damp cloth. This is the bronze-coloured plate you will see behind the transfer wire when you open the

Power Supply

Fuser Roller Cover

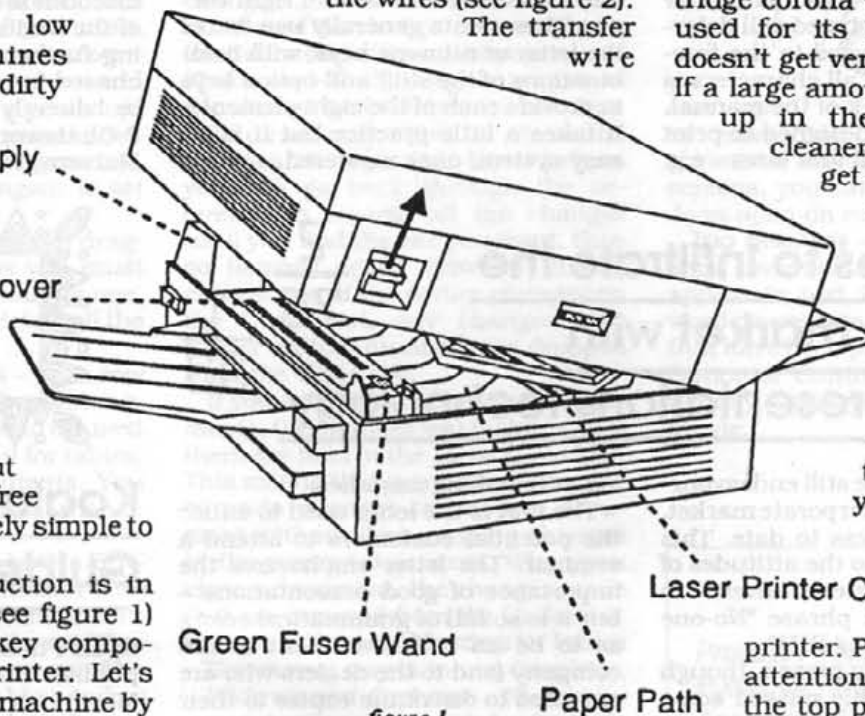

figure 1

Green Fuser Wand

Paper Path

Laser Printer Corona Wires

is the barely visible long wire under the short, diagonally crossed corona wires. This should also be cleaned. Be gentle - these are fragile and expensive to replace.

The corona and transfer wires are next to the black plastic ridged paper path in the centre of the machine. A sign that the corona wires need cleaning is vertical streaks,

printer. Pay especially close attention to the space below the top plate. This is where the paper moves through.

The fuser wand is the black plastic wand with the fuzzy green handle. the felt strip on the bottom cleans the fuser rollers which bind the toner to the paper with heat and pressure. Check the white felt of the fuser wand for buildup of residue. If it is excessively grimy, gently scrape off into the trash with the edge of a paper clip or similar firm edge. If this does not help then replace the



wand. The wand is vital for the proper operation of the laser printer and should be replaced whenever the cartridge is changed. Extra wands can be purchased from dealers and toner cartridge manufacturers.

The separation belt is a 3-inch long clear plastic strip that guides the paper and prevents jamming (see figure 3). It is located on the opposite side of the machine from the open-lever. It attaches to a peg on the surface of the transfer guide, threads over one roller and under another, and hooks onto a thin, metal peg above the paper path. This peg is directly across from where the green corona wire cleaner for cartridges is stored. Replacement separation belts are typically stored between the corona wire cleaning tool and the edge of the machine. If you need more you can purchase them from an Apple dealer.

You can typically tell if the separation belt is dirty just by examining the belt itself. A black smudge on the right side of printed copy also means the separation belt may need cleaning.

To clean the separation belt, detach the end loop from the metal peg by pulling it gently to the left about two millimetres. Hold that end with one hand and lift the top roller off of the belt. With your other hand grasp the top of the belt between thumb and forefinger. Gently draw the belt through this delicate "pinch-hold" a few times to clean off any toner smudges, then, still holding the end loop, thread it back through the rollers and hook it on the peg. This requires a little dexterity, and may take some practice before you feel completely comfort-

able with it. If you use a dampened cloth or cotton swab to clean the separation belt, be sure only to use water. Alcohol and other solvents may damage the plastic. Vertical black lines on your printed copy indicate that you need to clean the toner cartridges's corona wires as shown in the diagram below. These lines may vary from occasional pencil thin marks to uneven "drops of paint" smeared down the page. They characteristically do not appear in the same place on every page. Remove the cartridge from the printer. Hold it flat as shown to

avoid spilling toner. Use the green cartridge corona wire cleaning tool (see figure 4) which is stored inside the printer near the latch. Insert the corona wire cleaner finger into the long slot on top of the cartridge with the tooth away from the handle (see figure 5). the cleaner fits in easily this way and doesn't work at all if reversed, so you'll know right away if you've

placed it correctly. Pop the tool into place, moving it all the way in until the plastic tool meets the body of the cartridge. You will not damage anything. The flexible plastic film that moves to the side is to protect the drum from light. Slide the tool lengthwise six times as illustrated then gently remove. It may "poing" on removal, but this should not hurt the wire. If the corona cleaning tool looks dirty, it can be cleaned by gentle vacuuming.

Stains on the back of a page indicate that the paper path may need cleaning. Wipe it

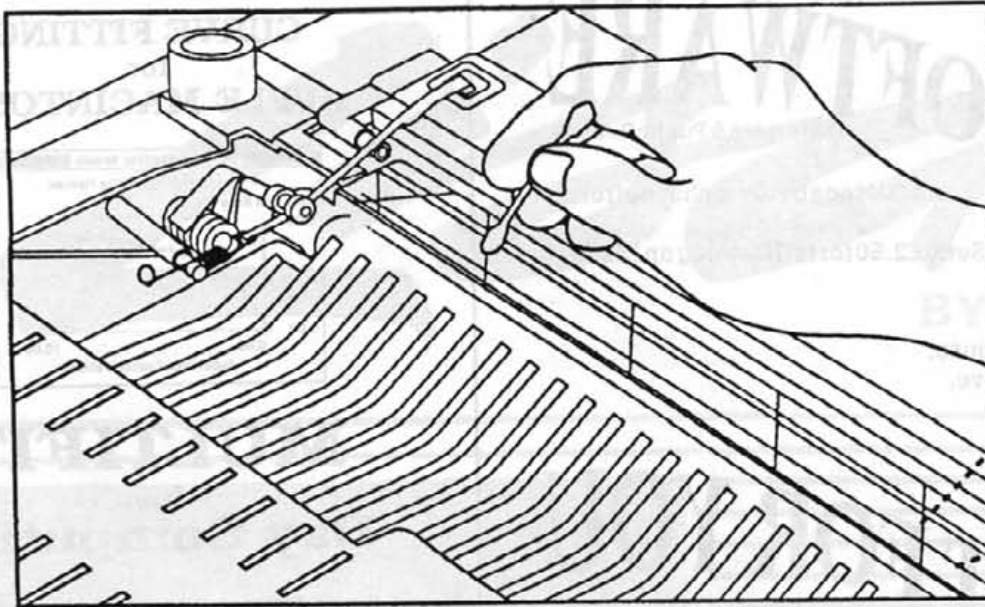

Figure 2

Printer Corona Wires  
Transfer Wire

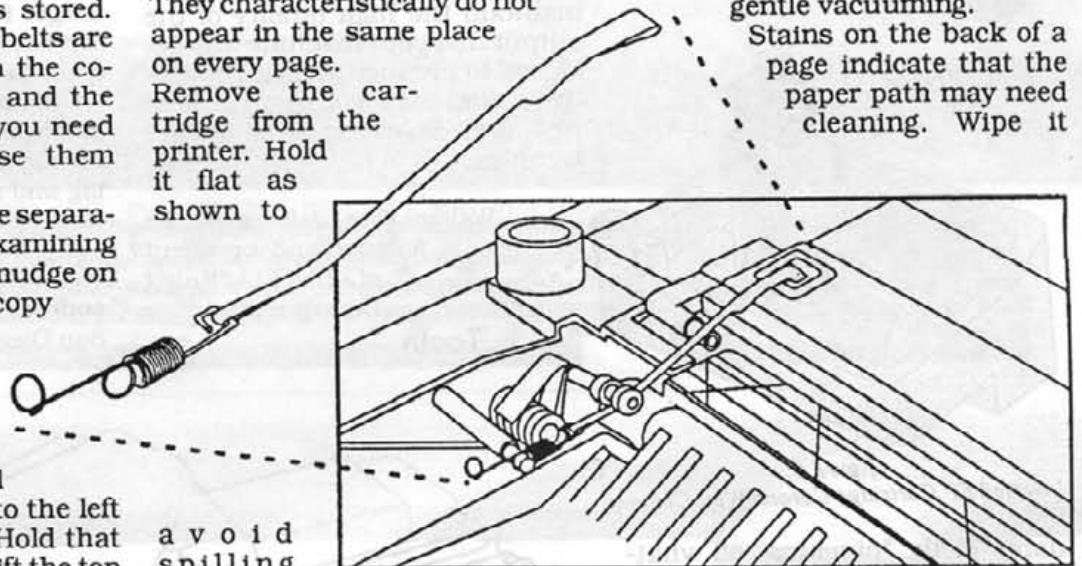

figure 3

with a tissue or soft, barely damp cloth. Be careful of the fine teeth near the corona wires which can catch your cleaning cloth. These stains could also be a symptom of dirty fuser rollers. The fuser rollers are located under the fuzzy green cover near the paper output tray. Clean them using a barely

THE BEST

# FREE SOFTWARE

Shareware & Public Domain

Over 100 Megabytes to choose from.

Send £2.50 for full Catalog on Disc

MACWISE,  
Enterprise House,  
Howards Grove,  
Southampton,  
SO15PR

0703-224957

# DIRECT FOR YOU

£5 per Disc

All the latest from the U.S.A.



## CURVE FITTING for APPLE MACINTOSH

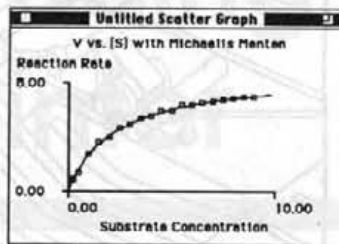

## MULTIFIT from Day Computing

Non-Linear Regression to User-defined model.  
Simple and Multiple Linear Regression  
Polynomial Regression up to ninth order.  
Robust (Median) Fit for outlier elimination.  
Scatter graphs  
and much more...

£80 (including carriage)

P.O.Box 327, Milton, Cambridge, CB4 4WL, UK

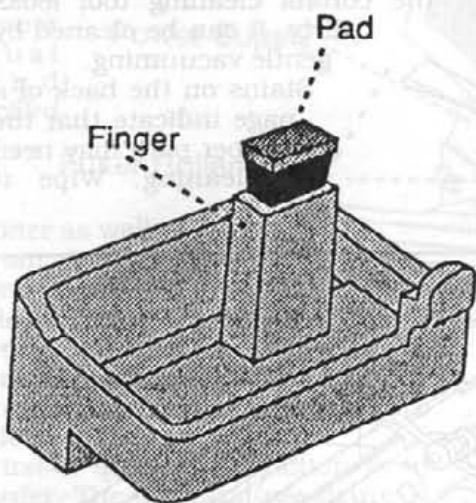

figure 4

Inverted EP Cartridge Corona Wire Cleaner

regular basic cleaning you will maintain the high quality of the output that your machine was designed to produce. A little preventive maintenance can go a long way and save you from future troubles.

Walter Vose Jeffries is the founder and president of BlackLightning Incorporated, a

Tooth

leading manufacturer of toner cartridges for laser printers and photocopiers. He has been writing reviews and articles for computer magazines for the past seven years. When not managing BlackLightning or writing he may often be found contra-dancing and scaling the cliffs near Hartland, Vermont where he lives.

This article was reprinted from **Resources**, the official magazine of the San Diego Macintosh User Group.

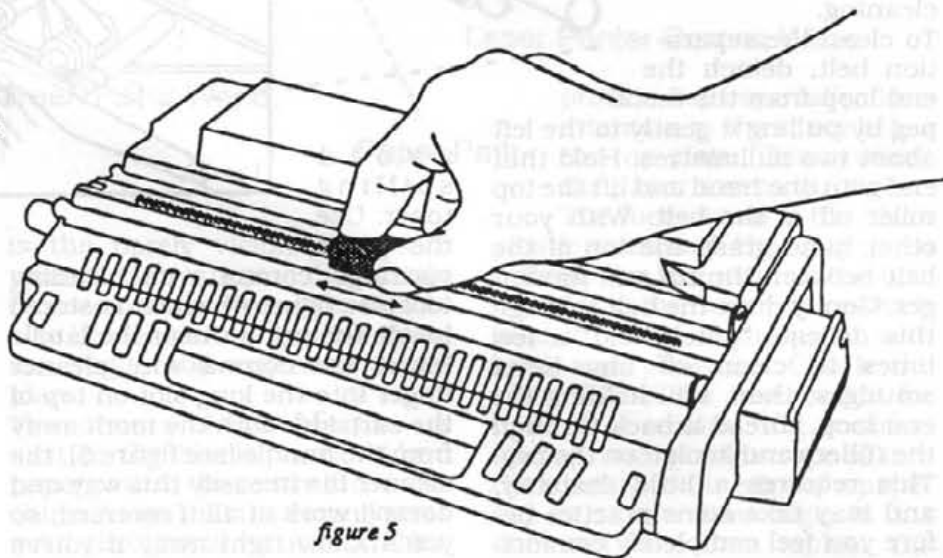

figure 5

damp cloth, "pinching" off whatever dust you have wiped up at the end of the roller. Dry them off with a clean cloth. Cleaning may also be done with a clean dry cloth if the roller is not extremely dirty.

**Be careful** of the fuser roller area - it is quite hot. The green felt cover diffuses the heat fairly well, but the rollers are uncomfortably hot and could burn you if you touched them for too long.

By giving your laser printer a



THE MAC YOU ALWAYS WANTED . . . . .

# Lisa



BY APPLE

**PRICES AS LOW AS £1100**

(plus VAT and shipping)

**LISA PROFESSIONAL  
COMPUTER SYSTEMS**

WITH

**10, 20, 30, or 40 MB Hard Drive**

**MACINTOSH SOFTWARE  
COMPATIBILITY**

**800K Disk Drive**

**12 Inch Screen**

**Keyboard with Integral  
Numeric Keypad**



**MACINTOSH SOFTWARE  
COMPATIBILITY**

**DISTRIBUTED  
IN EUROPE BY**

*MacSolutions*  
UK LIMITED

**Complete Upgrades available  
for Lisa & Mac XL  
90 Day Warranty  
Unlimited Telephone Support  
User's Group Membership  
Macintosh User's Group or Apple 2000**

**Carlton Street  
Bradford  
West Yorkshire BD7 1DA  
Telephone: (0274) 394636**

# N-Font

## Convert FONT to NFNT - here's how!

**Overview** N-Font is a FreeWare application from OLDUIVAI Corporation. It allows users to easily convert the older FONT screen fonts to the newer NFNT screen fonts. The relatively new NFNT screen fonts contain actual screen variations of styles such as Bold, Italic, and Bold Italic. This provides the ability for font menus to show one font name, while displaying 'another' screen font, depending on Style menu selection(s).

Only Version 3.8 or later of Apple's Font/DA Mover is capable of handling NFNT's. The most recent version of System Software is available at any Apple dealer.

### Introduction

(or, "What's this NFNT stuff about?")

Files on the Macintosh are stored as data (unstructured information) and/or as resources (structured data). Prior to the Macintosh Plus, all Macintosh screen fonts were specifically one resource type, aptly named FONT. These fonts were always 'plain' fonts, requiring the Macintosh to produce styles such as bold, italic, or bold italic by shifting or slanting characters. While these variations looked good on the screen, they did not give a truly accurate representation of the printed typeface. This was especially true with the first laser printers, where the screen fonts displayed one spacing and the printer output had another spacing.

With the advent of the 128K Macintosh ROMs (first placed in the Macintosh Plus), font manufacturers began including stylized screen fonts, each providing a more accurate representation of its printed counterpart. When

this was done, a number of screen fonts existed for one typeface family. An example is where the Helvetica typeface family had four separate screen fonts: 'Helvetica,' 'B Helvetica Bold,' 'I Helvetica Italic,' and 'BI Helvetica Bold Italic.' (In case you were wondering, the B, I, and BI were at the beginning of font names to get the style identification right up front, since some of these names can get very long and the tail end may not be visible on the menu.)

Each of these appears as an item on the Font menu. To use the bold Helvetica, you can either choose B Helvetica Bold from the Font menu or choose Bold on the Style menu. The family is tied together with a new resource called FOND which carries information common to all its related FONTS. If you have several of these font families installed, the Font menu can get pretty cluttered. It'd be more convenient if the styled font variations didn't appear on the Font menu, instead just chosen from the Style menu.

At the same time as the FOND, Apple defined a second type of font resource, called NFNT (New FONT). These NFNTs lend themselves more thoroughly to the font family concept by showing only the family name on the Font menu (like "Helvetica"). An important benefit of the NFNT font is allowing the family (FOND) identification number freedom to go beyond the original limits of 0 to 255. Now allowing ID numbers up to 32767, confusing FOND ID conflicts will hopefully be rare. Only the 128K and later ROMs recognize NFNTs; the older Mac 128 and Mac 512 simply ignore them.

If you desire a more technical explanation, see the Font Manager section of Inside Macintosh Volume V.

### How to Use N-Font

**NOTE:** N-Font WILL NOT change any font files; it will only convert other font files, creating a new NFNT-based font file. However, you should always habitually use a copy of the screen fonts, and not use the master disk.

There are two ways to operate the N-Font application. Prior to starting either one, you must be sure ALL related screen fonts that are to be converted are placed in the same, single font file. This

requires that you place all four variations: plain, bold, italic, and bold italic into one file, using Apple's Font/DA Mover. Also be sure not to mix/match unrelated screen fonts in one file.

The easiest of the two methods for using N-Font requires you to place the screen fonts files you wish to convert into a new folder along with a copy of the N-Font application. Within this folder, double-click on the N-Font utility and click on the Convert Folder button. Now you can just sit back and watch N-Font process the older font files. In a few moments you will have a new NFNT font file for each font you converted. After converting all font files in that folder, N-Font will quit automatically. All new files will have the characters NFNT placed at the end of it's name to help identify the new NFNT formatted file.

The other way to convert font files is to specify them individually. This is also a simple process. After starting the N-Font application, click the Convert... button. N-Font will then show a standard open dialog, where you must navigate to the font file you wish to convert. Select the font file name and click Convert (or double-click the file name) so that N-Font can ask you to name the new, converted file. After specifying the name file name, click Save and the conversion process will begin. When the conversion of each font file is completed, you will return to the dialog allowing you to convert another. If you are finished at this point, click Exit. Otherwise, start the process again.

**NOTE:** You must use version 3.8 or later of Font/DA Mover with NFNT's. After converting your font, you must run Font/DA Mover 3.8 to install them into your System file. While N-Font has been tested compatible with hundreds of typefaces, there are bound to be strange/new/home-made typefaces that will not work. Since we are constantly updating N-Font, we'd like to hear if you have any problems with any downloadable typefaces so we can provide future compatibility.

As N-Font is a fairly simple program and FreeWare, it is not supported by Olduval.

**N-Font can be obtained on one of this month's Macintosh Library Update Disks.** 





## Irene Flaxman learns how to use Aldus' new program, with the help of Personal Training Systems

The latest in the series of self-teaching guides from Personal Training Systems is 'Learn Persuasion'. I had not tried Aldus' Persuasion program, so this was an ideal opportunity to look at both products.

The Personal Training Systems courses are well-presented, providing tuition in a number of packages by means of a sample disk and instructions on an audio cassette. Each training course provides sample data, but you must already have the software available. Since you use the actual software, any mistakes you might make will be obvious immediately, so I have found this to be an excellent way to learn how to use a new program.

There are four Learn Persuasion courses -

- Beginning Persuasion
- Intermediate Persuasion
- Creating AutoTemplates
- Creating Artwork

I had the opportunity to look at the first three.

The tutorials introduced topics in a logical sequence, and at a rate which kept my interest but was not too taxing. They highlighted some of the less obvious features of the program, in addition to demonstrating all the basic functions. I felt quite confident that I

could create a high-quality presentation without further assistance, having completed the courses.

Although these are produced for the American market, they are still useful for the British user - I found just one special character which differs between the American and British keyboards, which might confuse. The presenters may be American, but they have pleasant voices, without heavy accents.

Aldus Persuasion is a piece of software which addresses the new Desktop Presentations market very well. It is certainly a very powerful package, but it is also very easy to learn. The presentation of the package is excellent, including a desktop reference guide in addition to the manual. The manual includes two tutorials which take you through all the elementary procedures, and lead on to some of the more advanced features, too. Other sections then go on to explain all of the functions of the package in an easy-to-read style. If you really do find yourself in difficulty, there is also an extensive on-line help facility, but I didn't find a need to use that.

The program will run on the Macintosh Plus, SE, II. A hard disk and a minimum of 1mbyte of

memory are required (more, if you want to use MultiFinder). System requirements are System 4.2 or later, Finder 6.0 or later.

The purpose of the program is to facilitate the preparation of effective slide presentations. Obviously, the skill and knowledge of the presenter are still essential requirements for the production of an effective presentation, but the program certainly eases the task of preparation.

The program works on a number of planes (or 'views' simultaneously, copying data between these planes where appropriate. The output can take several forms, including overhead slides, 35mm slides, speaker notes and handouts. Data may be input by direct entry (typing, drawing, or entry into a spreadsheet-type work area); or by importing text, outline, spreadsheet, or graphics data - there are some limitations as to what can be imported, but these are clearly stated in the manual.

How does Persuasion work? An outline is created by entering text which you wish to appear on your slide. A new slide is indicated by typing the slide heading at the left-most text position, and tabs are used to indicate a hierarchical structure within a slide. The outline can be viewed and edited at any time, and any editing will be reflected on the slides, notes and handouts. The positioning of slides may be adjusted by simply dragging the text to a new position as required.

Formatting of the contents of a particular slide is initially dependant upon the master template allocated to it - this determines where the title is to appear, and whether the slide should include body text, charts, graphics, organisation charts, tables, etc. The text which was entered into the outline will be formatted in accordance with the defaults set on the chosen master template, but any graphics must be applied directly to the slide - they will not appear on the outline view. The master template will include the standard formatting options you have chosen to give an overall style to the slides - but you can still edit an individual slide to suit your needs.

The package comes complete with 24 sets of templates

## Professional Presentations by:



already prepared for you (18 in monochrome and 6 in colour), but you can easily create a new style of your own and save it as a template for use in subsequent presentations.

The pull-down menus at the top of the screen include the standard Macintosh options, but additional menus are displayed as appropriate to the particular view and type of slide which are currently selected. There are also pull-up menus at the foot of the screen, again dependant on the current view.

Data which is to be used for charts or tables may be typed (or imported) into the presentation's work area, or may be included by choosing an external file. To create either a chart or a table (of which there are nine styles, with or without depth), simply select the slide, the style of chart required, and the data to be represented - then issue the 'plot' command. Only one work area is available for the presentation, although you may include several charts or tables in your presentation - you must plan your use of the work area, so that data will not overlap and select the appropriate data when creating each chart or table. When viewing the slide, a chart or table may be enhanced by formatting text, axis labels, legends, etc. You may even edit data within a table, and this will automatically be updated in the work area. If you wish to change the style of chart, though, you must delete the chart from the slide and return to the work

area (or external file) to replot the data using a different style.

The usual options for moving, stretching, rotating, etc. are available when viewing an individual slide or when viewing a master template (if you want to make changes to all slides of that style).

Three alternative presentations are available for organisation charts, with up to ten levels allowed. The use of tabs indicates the hierarchy to be portrayed, and Persuasion formats accordingly. If you want to show a two-line entry (e.g. name, with title beneath), this is also accommodated, using the key combination of shift-return to indicate that the title should be on a new line, but should not be treated as a new entry.

There is a slide sorter facility, which allows you to view all your

slides as 'thumbnails' (in a choice of four sizes, to ensure that you can view them all). This allows you to judge at a glance whether the format is pleasing, and whether the slides will be displayed in the correct order. Slides can easily be repositioned whilst in this view, and an individual slide can be selected for attention.

The final feature of the program which I want to mention is the slide show. This allows you to see how the slides would appear if you printed them, but it also allows you to use the Macintosh to make your final presentation - either with a large screen, or using a 'viewframe' with an overhead projector. The advantage of using your Mac for the final presentation is that you can set layers on your slides, so that data is revealed in stages.

I could not try the 35mm slide option, as I do not have ready access to the appropriate equipment - but I have seen samples of the output. The manual points out that you should initially try printing a sample slide (either in-house, or send to a bureau) before creating the full presentation, to ensure that you have all options set correctly, and that the colours are reproduced as you require. This is sound advice as slide production is not cheap, and any errors in your settings could be very costly in time if you find that you have many slides to correct.

Overall, I was impressed. I could not think of any features which I would like to add, the documentation was well-presented, and the program was very easy to use. 🍏





# Heraldry III

Heraldry III by Pleasant™ GraphicWare is reviewed by John Arnold.

Heraldry and Heraldry II are each issued as 400k disks, with Heraldry III containing all the material of the previous two disks on a 800k non copy protected disk. This click-art material is presented in the form of a number of MacPaint documents, and tries to serve two purposes. The first is the usual click-art objective, that is, of images which can be cut and pasted into your own documents.

A second objective for this package, perhaps slightly unusual for a Clip-art disk, is that of presenting explanations of some of the Heraldic terms, so the MacPaint screens, apart from containing the usual Clip-art images, also contain a fair amount of text. There appears to be no documentation provided with the disk, so probably the first action a user should perform is to print all the screens, which would then serve as a catalogue of the images. There are some thirty-five screens, with the number of images per document ranging from 1 to 45 or so.

The medieval art of Heraldry probably had it's origins at the end of the eleventh and early twelfth century, certainly around the period of the Third Crusade (1189) weapons of warfare were decorated with designs which

were handed down within a family.

As might be expected with something whose beginnings go so far back in time, it has over the centuries developed into an immensely rich and complex subject. The initial purpose was to enable individuals participating in battles to be recognisable at a distance, by the designs and colours used in the decorations on their shields and armoury.

The 'A' files on the disk give the black and white representations of the 'colours, metals and furs' that are conventionally used on the 'field' (the area enclosed within a shield), examples of fields powdered with objects ('semé'), and a page of shield designs. Subsequent pages give examples and explanations of 'partitioning', 'the saltire', 'the chief', and a number of other Heraldic terms. Three F pages give examples of the Cross in many of it's variations :- 113 in all. Further standard Heraldic terms are

given in the next few pages, with the 'charges' i.e. the images which can be placed on the shield starting at file J and ending at file V.

The final three pages illustrate complete achievements of Arms, with crest, supporters and base. Most of the images are original, rather than scanned, and obviously a considerable amount of effort has gone into the production of the pages. So how successful do I consider the disk to be? Firstly, I do not think that using MacPaint it is possible to do real justice to the complex designs that make up the majority of Heraldic Art. MacPaint is good at horizontal and vertical lines, but



Gibraltar  
(rare use of lettering on field)

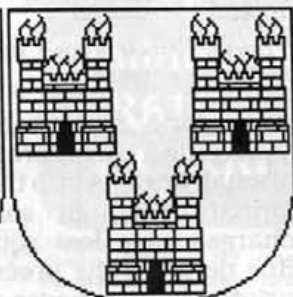

Dublin



Great Central Railway

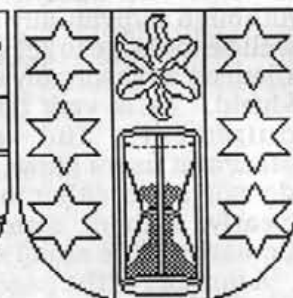

Greenwich

as most of us know, it is poor for curved lines in general. This fact is immediately apparent in the shields, on the first two pages where the stepped lower curved edges are very noticeable. Seventy two dots per inch may sound



Tuvalu

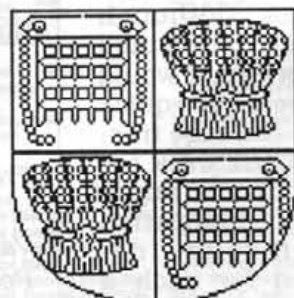

The Duke of Westminster



Richard II

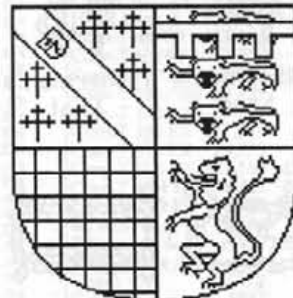

The Duke of Norfolk,  
Hereditary Earl Marshal  
of England



King Manuel of Portugal, 1910    Avis Order    Order of St. John of Jerusalem    Count Frederick Cilli    Byzantine Empire    Families of Lucerne, c1308    Lord Baltimore

plenty, but it certainly restricts the amount of detail that can be used for representing many of the more complicated charges.

Having said that, the authors

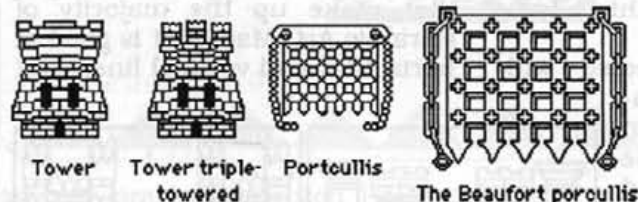

Tower    Tower triple-towered    Portcullis    The Beaufort portcullis

have done remarkably well in squeezing a considerable number of small designs into the MacPaint format, although some of the charges have lost some of their fine detail in the process. When printed out the pages do however look quite attractive. Secondly as a Clip-art disk, I also have reservations. The individual charges although individually small, may well be too large to get a number of them on a reasonably sized single shield, as is very often the requirement, and again as MacPaint users know, bit-images do not scale either up or down clearly, without distortion, particularly in the small sizes.

A number of the pages contain a considerable amount of text, which would not be of use in the Clip-art aspect of the disk, and also there is a fair amount of white space on some of the pages. Heraldic Art is very rich in images, and although the disk contains a goodly number, it by no means covers anything like the total possible (probably an impossible task anyway).

Thirdly as a résumé of Heraldic terms the disk seems to do a reasonable job, the basic terms are certainly there, all illustrated with examples, but a number of things were missing, for example illustrations of different crests, and supporters, only three examples are given, and those are on the last three pages, where the complete Achievement of Arms is illustrated. (The illustrations again showing severe signs of the MacPaint limitations). What is a surprising omission however is the lack of any formal 'blazons' (the written description in Heraldic terms of the designs to be placed on the shield, and their precise positions, with details of crest and supporters, etc.), just the information that would be vital to anyone attempting to construct a Heraldic emblem for a client.

Some of my objections could be eliminated if a program such as Illustrator was used instead of MacPaint. The images presented here, could I am sure, be used as a background template to produce relatively smooth curves, although having attempted one or two, it would not be a very quick task, the edge tracing didn't work too well for me, and a small application specifically designed for such a task, also produced results that were far from perfect. However I feel that this approach would certainly produce art work that could be scaled, and would have some of the smoothness to the curves, which is absolutely vital for the production of Heraldic Art.

As a first attempt, Heraldry III contains the fruits of a lot of work, I hope the authors will take the idea further, and produce a set of Illustrator files. For purchasers of the Heraldry III disk who are unfamiliar with Heraldry, I hope the images contained therein awaken an interest in what is a fascinating subject.

ever I feel that this approach would certainly produce art work that could be scaled, and would have some of the smoothness to the curves, which is absolutely vital for the production of Heraldic Art.

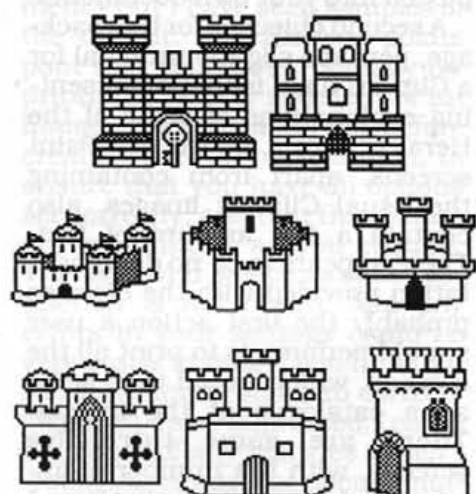

Styles of castles and towers

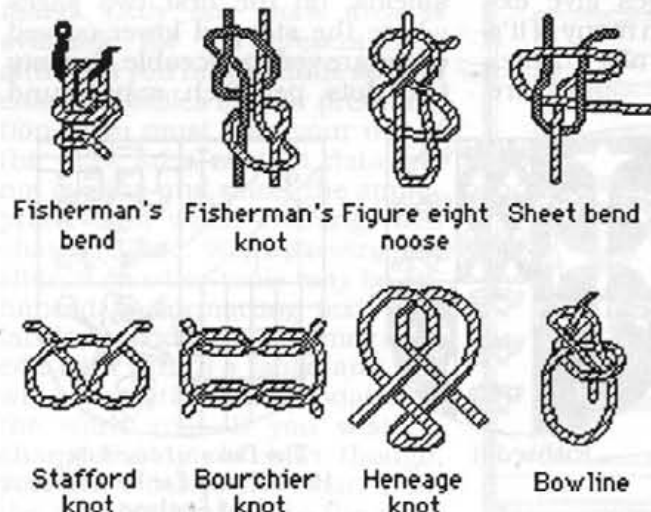

Fisherman's bend    Fisherman's knot    Figure eight noose    Sheet bend    Stafford knot    Bouchier knot    Heneage knot    Bowline

info

Product : Heraldry III  
 Publisher : Pleasant™  
 GraphicWare

Available from :  
 P.O. Box 506  
 Pleasant Hill  
 OR 97455 USA

Price : \$82.90

Value :            🍏🍏🍏  
 Performance :    🍏🍏🍏  
 Documentation :   none



# MacSoft

Bridge House • Wellington • Somerset • TA21 0AA  
Phone 082-347-3625 or 5834 • FAX 082-347-3477

Phone lines open from 9.00am to 7.00pm, Monday to Friday.  
UK postage: £2.00, but post-free for orders over £100 (1st class recorded post). Overseas postage: 7% of order value.  
Pay by Cheque, Access, Amex or Visa. V.A.T. IS INCLUDED IN ALL PRICES UNLESS STATED. Product pricing and availability subject to change without notice.  
Foreign orders welcome (Divide prices by 1.15). E&OE.

Quality Products at Unbeatable Prices  
And if we don't post it to you in 7 days (14 for hardware), we'll take 5% off the price!



## KEEPING AHEAD OF THE PACK, BRINGING YOU THE BEST, FIRST

Product VAT incl VAT excl Product VAT incl VAT excl Product VAT incl VAT excl Product VAT incl VAT excl Product VAT incl VAT excl Product VAT incl VAT excl

### SOFTWARE BARGAIN OF THE MONTH

**Multi-Ad Creator**  
**£769.35**  
(VAT incl)

### SOFTWARE

• Adobe Illustrator '88	£488.75	£425.00
• Adone Graphist Pnt II	£458.85	£399.00
• Allsys FONTastic+	£67.85	£59.00
Fontographer	£258.75	£225.00
Keymaster	£102.35	£89.00
• Chang Labs C.A.T.	£309.35	£269.00
• Computa Label MacBarcoda	£631.35	£549.00
• Cricket Software Cricket Draw	£182.85	£159.00
Cricket Graph	£146.63	£127.50
Cricket Pres.	£286.35	£249.00
• Electronic Arts Delux Music CS	£57.44	£49.95
Studio 8	£293.25	£255.00
• Deneba Canvas 2.0	£224.25	£195.00
• Fox Foxbase Single	£368.00	£320.00
Foxbase Multi	£598.00	£520.00
• Icon Technology MacAuthor 2	£224.25	£195.00
formulator	£148.35	£129.00

### 3 1/2" Disk Laser Labels

50 Sheets	£10.35
100 Sheets	£18.40
500 Sheets	£86.25
Formatting Disk	£10.35

These labels (12/label) are exact size, flush fit, normally unobtainable in the UK. Format disk contains template for most DTP programs. Call for free sample

### Toner Cartridges

New Black	£79.35	£81.65
New Blue or Brown	£126.50	£136.85
New Light Blue or Red	£178.25	-
Recharge	£51.75	£51.75
New JUMBO (50%+)	£97.75	-
Recharge JUMBO	£77.05	-

### Upright II stand £45

### 3 1/2" Floppy Disks

Double Sided  
**100% LIFE GUARANTEED**  
£18.40 for 12  
Includes FREE Anti Virus & IA Sampler disks

• IDD Dreams	£303.60	£264.00
MacDraft	£201.25	£175.00
• Inovatic OCR ReadStar II+	£1,006.25	£875.00
• Informix WingZ	£316.25	£275.00
• Letraset Letrastudio	£458.85	£399.00
Letrafont (ea.)	£75.90	£66.00
Standout	£396.75	£345.00
• Living Videotext MORE II	£286.35	£249.00
• MacroMind VideoWorks II	£166.75	£145.00
• Mainstay Capture	£45.94	£39.95
MacFlow 2	£159.85	£139.00
• Micro Planning Microplanner 6	£458.85	£399.00
• MicroSoft QuickBasic	£97.75	£85.00
Excel	£251.85	£219.00
Mail 1-4 users	£194.35	£169.00
Mail 1-10 "	£343.85	£299.00
Mail 1-20 "	£546.25	£475.00
Mail 1-32 "	£803.85	£699.00
PowerPoint II	£251.85	£219.00
Word V3	£251.85	£219.00
Works V2	£194.35	£169.00
• Orange Micro RagTime 4	not yet announced	
• Quark Xpress V2	£626.75	£545.00
Style	£281.75	£245.00
• Silicon Beach Software Dig.Darkroom	£228.85	£199.00
Silicon Press	£51.75	£45.00
Super 3D	£178.25	£155.00
Sup3D II	£339.25	£295.00
Superpaint II	£136.85	£119.00
World Builder	£43.13	£37.50
• Solutions The Curator	£97.75	£85.00
• Symantec (Think) Capps Prime	£43.13	£37.50
HIPs Navigator	£31.63	£27.50
Just Enough Pas	£57.44	£49.95
LightSpeed C 3	£128.80	£112.00
LightSp Pascal 2	£79.35	£69.00
S.U.M.	£67.85	£59.00
• T/Maker C/A PostScript	£102.35	£89.00

WriteNow II	£134.55	£117.00
• Turner Hall Publishing MacSOZI	£63.25	£55.00
• Wolfram Mathematica	£493.35	£429.00
Mathematica II	£799.25	£695.00
• WPC WordPerfect	£224.25	£195.00
GAMES Apache Strike	£31.63	£27.50
BeyondDarkCstl	£31.63	£27.50
BOP 1990	£26.18	£24.50
Chessmstr 2000	£30.48	£26.50
Chuck Yeag AFT	£30.48	£26.50
Colony	£36.80	£32.00
Crazy Cars	£22.43	£19.50
Dark Castle	£31.63	£27.50
Deja Vu II	£28.18	£24.50
R-16 Falcon V2	£41.98	£36.50
Flight Simulator	£44.85	£39.00
Ferrari Gr/Prix	£39.68	£34.50
GATO	£26.18	£24.50
Orbiter	£26.18	£24.50
PT-109	£41.98	£36.50
ShadowGate	£33.35	£29.00
Uninvited	£26.18	£24.50

### LASER FONTS

• Adobe Typefaces (1-97) (Mac or IBM & Compatible)		
14,37,47,68,69,72	each are	£317.40 £276.00
#23,31,38,39,40,41,42,44,46,49,57,63,64,70,71,79,80	each are	£240.35 £209.00
#3,10,22,29,32,33,43,45,50,53,55,56,58,59,60,73,76,87	each are	£120.75 £105.00
#21,25,35,75	each are	£79.35 £69.00
All others	£155.25	£135.00
IBM Screen Fonts set of 10	£155.25	£135.00
• Casady FluentLaserFonts	£67.85	£59.00
Compugraphics Garth Graphic, Antique Olive, Collage, Nashville Med, Novarese Book, Shannon Book, Symphony, Triumvirate.	each are	£159.85 £139.00

• LaserPerfect LaserPerfect have produced some of the more obscure fonts. eg. Hebrew, etc. Call for details.		
• Lexitrope BorderFont I/II	£67.85	£59.00
• Monotype (Mac & IBM) Arial, Bembo, Plantin, Times New Roman & NR P.S.	each are	£159.85 £139.00
Gill Sans, Rockwell	each are	£228.85 £199.00
• Software Complement Compl. Type	£67.85	£59.00

### HARDWARE

Memory (RAM) Upgrades		
Add 1Mb to Plus	£270	£235
1Mb SIMMS	£224	£195
Jackie	£903	£785
Accelerators for Plus		
Mac20MX-16	£684	£595
Mac20MX-25	£1,144	£995
MC68881-16	£229	£199
MC68881-25	£569	£495
Accelerator for Mac II 33/030	£4,888	£4,250
• Dataflex (MODEM) Stradcom (BT approved)	£206	£179
(Vicom III)	£183	£159
• LaserGraphics Film Recorder	£9,194	£7,995
• Summagraphics (SE/II Digitizer) New Bit Pad Plus	£339	£295
• SUN Tops Mac	£171	£149
Tops Flashbox	£114	£99
• Nutmeg Displays 19+ for Plus	£1,553	£1,350
19 for SE	£1,351	£1,175
19 for II	£1,489	£1,295
19 Gr/Sc for II	£2,243	£1,950
19 UI/Vw Col II	£3,853	£3,350
Xerox FPD	£1,144	£995
Xerox 19"	£1,432	£1,245
Scanners Scanjet Plus 256GSE	£1,954	£1,699
H/tek Col. A3	£9,143	£7,950
H/tek Col. A4	£7,786	£6,770
H/tek Col. 35mm	£10,638	£9,250
Cognicor OCR	£2,995	£2,850

**HARDWARE BARGAIN OF THE MONTH**  
**CTi Combination R61/42**  
**£1,599**  
(61Mb Ext. + 42Mb Removable)

Printers (PS 300 dpi) Business LP	£3,278	£2,850
PixelMaster(col)	£8,568	£7,450
HARD DISKS CTi "NEW UK made HDs" Internal Hard Disks		
CTiNT 20	£374	£325
CTiNT 30	£420	£365
CTiNT 46	£535	£465
CTiNT 61	£661	£575
CTiNT 80	£857	£745
CTiNT 100	£1,103	£959
CTiNT 150	£1,668	£1,450
CTiNT 286	£2,956	£2,570
CTiNT 573	£5,279	£4,590
External Hard Disks		
CTi 20	£459	£399
CTi 30	£528	£459
CTi 46	£608	£529
CTi 61	£643	£559
CTi 80	£965	£839
CTi 100	£1,144	£995
CTi 150	£1,823	£1,585
CTi 286	£3,151	£2,740
CTi 573	£5,589	£4,860
CTi 858	£8,027	£6,980
CTi 1.14	£10,465	£9,100
CTi 1.72	£14,260	£12,400
CTi 2.29	£17,595	£15,300
Removable Hard Disk		
CTi R42	£1,068	£929
CTi R/Cartridge	£132	£115
Tape Back Up only		
TCti 60	£677	£589
TCti 150	£1,058	£920
TCti EX 291	£4,807	£4,180
Fixed & Removable HD Combo		
Comb-R46/42	£1,564	£1,360
Comb-R61/42	£1,599	£1,390
Comb-R80/42	£1,886	£1,640
Comb-100/42	£2,116	£1,840
Hard Disk & Tape Combos		
Com-T 46/50	£1,254	£1,090
Com-T 61/60	£1,300	£1,130
Com-T 80/125	£1,898	£1,650
Com-T 100/150	£2,139	£1,860
Com-T 150/150	£3,094	£2,690
Com-T 286 EX	£7,349	£6,390
Com-T 573 EX	£9,775	£8,500
Com-T 858 EX	£12,190	£10,600
Com-T 1.14 EX	£14,605	£12,700
Com-T 1.72 EX	£16,330	£14,200
• TwinWrite	£684	£595
(Mirroring software on 2 drives)		
• Rodime (Other sizes pls call) Cobra 45i	£879	£764
Cobra 45e	£947	£823
Cobra 70i	£1,014	£882
Cobra 70e	£1,081	£940
Cobra 100i	£1,251	£1,088
Cobra 100e	£1,318	£1,146
Cobra 215i	£1,656	£1,440
Cobra 215e	£1,724	£1,499
• Second Wave Expanse & Plus	£715	£622

### instant art 300

11Mb of animals, birds, fish, reptiles, etc.	£110	n/a
4.8Mb of festive season images	£88	£34
4Mb of images of children doing what children do	£88	£34
3Mb of educational images, from all ages	£88	£34
4.8Mb of illustrations of food and drink	£88	£34
4Mb more of illustrations of food and drink	£88	£34
2.4Mb of hands with tools, food, holding cards, etc.	£88	£34
3Mb of medical & health illustrations	£88	£34
3Mb of illustrations of men's heads in various activities	£88	£34
4Mb of sea associated images, from the beach, to over water & under it	£88	£34
3Mb of theatre & stage related images	£88	£34
3Mb of images of recreational sports: Ballooning, skydiving, archery etc.	£88	£34
3Mb of images of sports: Skiing, cricket, golf, rugby etc.	£88	£34
5Mb of travel related images: Pyramids, Eiffel Tower etc.	£88	n/a
75 dpi files of the UK with roads, railways, counties, cities etc.	n/a	£34
4.8Mb of wedding images for cards, invites etc.	£88	n/a
3Mb of modern women's fashion studios	£88	n/a
3Mb of women's heads in various activities	£88	£34
3.2Mb of EPSF files of the UK with roads, railways, counties, cities etc.	£110	n/a
EPSF outlines of greater Europe	£110	n/a
EPSF files of individual countries with major cities, towns, roads etc.	from £40	n/a
All the British Tourist Board Symbols as EPSF files	£102	n/a
Over 200 British Tourist Board Symbols	£56	n/a
9 shades of grey for each font. (per font)	£56	n/a
Watermark effect for Times, Helvetica & Symbol	£52	n/a
Watermark effect for all LW+ Fonts	£102	n/a
Adds Fractions (eg. 2/3) to Times, Helvetica & Symbol	£52	n/a
Adds Fractions to all LW+ Fonts	£102	n/a
We can add fractions to any downloadable PostScript font	£88	n/a
50 forms in PICT, MacDraw, Superpaint or Pagemaker format	£56	£56

All Instant Art Graphics are also available for IBM & Compatibles and on WORM disk (Panasonic etc)  
Instant Art Sampler Disk: £7

We're not going to be undersold ... provide proof of a genuine better offer for any product listed here from anyone in the UK within 14 days of purchase and we'll refund the difference.

# Network News

The latest news, tips and gossip  
from the networks.

## From Usenet

From: Jerry D Whitnell  
Subject: Re: **Prototyper opinions?**

dave@emerald.PRC.Unisys.COM (David Lee Matuszek) writes... "I am thinking about purchasing Prototyper, by SmetherBarnes. Is this any good? Is there something better?"

I have Prototyper 1.0 and am a beta site for 2.0. In general, it delivers what it promises and is relatively bug free (at least the 1.0 is, I can't comment on the quality of the beta 2.0). There was a similar product announced at MacWorld (at least I picked up a brochure for it), but I have not seen the product itself. I'd recommend to all beginning Mac programmers and any non-beginners who either need to put together quick-and-dirty but Mac-pretty applications or who like to play with the user interfaces of their programs before casting them in concrete code. As an example, I used it on a recent contract that needed to be done quickly. The buyers were even willing to have a stdio interface if it would take less time, but with Prototyper I was able to throw together a real Mac interface and generate code in 4 hours.

"Prototyper promises to let me build my interface in a Mac-like manner, then produce Pascal code I can use in my program. Does it deliver?"

In Prototyper, you basically draw your interface. You have one window that you specify your menus in (in 2.0 they can be hierarchical) by typing in the titles of each menu and the items in the menu. They give you default Apple, File and Edit menus to start with, which you can edit.

You can also have create any number of windows, which you can specify as normal windows, dialogs or alerts. You can then add to these windows, using a MacDraw-style palette interface, buttons, check boxes, radio buttons, lists, lines, pictures, static text and editable text. You can link the buttons to open other windows or dialogs and also link menu items to open and close windows. Version 2.0 will also support pop-up menus and provides a more complete set of commands for the links.

You can then "run" your interface to see what it looks like. This is basically a simple interpreter built into Prototyper that interprets your prototype. The links tell the interpreter what to do when you select a menu item or click on a button.

Once you are satisfied with your interface, you can then generate the Pascal code. The source code includes the main loop, control routines for the dialog boxes and alert boxes and code to handle the menus. It also generates resources in both RMaker and binary form. The code generated is reasonably good and requires little modification. There are place-holders where you'll need to add the code that does the real work, but these are commented so you can find them. The code is specific to your application so there is little redundant code. Version 2.0 will include C code generators as well as Pascal.

Version 2.0 is due out RSN. I recommend, however, you buy 1.0 and upgrade to 2.0 as 2.0 will have a major price increase attached to it.

Jerry Whitnell

From: Reid Ellis

Subject: Re: **Prototyper opin-**

**ions?**

David Lee Matuszek writes: "I am thinking about purchasing Prototyper, by SmetherBarnes. Is this any good? Is there something better?"

Warning: as of the last time I looked, Prototyper did not handle the "newer" bits of the Macintosh user interface like popup menus, hierarchical menus, and tear-off menus. Also, it only created Pascal code. Now you are using Pascal, so that's ok.

I played with it a bit in June of last year and it seemed primitive, sort of archaic in what it would and would not handle. Of course, if your needs are simple, this may be the program for you. Personally, I was very disappointed with the product. But then again, I know of no better alternate for you to try..

Reid

## From InfoMac

From: Chris Johnson  
Subject: **Gatekeeper v1.1**

GateKeeper version 1.1 - Bugs fixed, features added, and finally ready.

Simply put, GateKeeper attempts to make it impossible (or as difficult as possible) for viruses to spread or function successfully in its domain. It does so by monitoring and limiting access to certain system operations on which viruses depend. Thus GateKeeper is a general purpose tool in the fight against viruses, as opposed to programs written to stop only a specific virus or set of viruses.

Once configured, GateKeeper operates without the need for intervention by the user. It provides facilities for warning the user of its intervention in the operation of the system, but will never require that the user to make decisions on-the-fly about what operations should be allowed to occur or forced to fail. GateKeeper ensures that such decisions are made automatically, transparently to the user and with total consistency. It will also, if requested, keep a detailed log of all such decisions for later review.

GateKeeper is NOT a virus removal/repair utility. GateKeeper endeavors to prevent viruses from infecting your system in the first place, and attempts to render them harmless if they should



find their way in.

GateKeeper also provides powerful diagnostic facilities for those intent on tracking and analyzing viruses in the form of a log file to which records of the critical operations attempted by viruses are written.

I have tested GateKeeper against the Scores, nVIR, Hpat, INIT 29 and ANTI viruses and found it to be thoroughly effective in rendering those viruses impotent.

From: Anders Liljegren  
Subject: **Bold Symbol font**  
Hi!

I have some problem getting the LaserWriterII to print the Symbol font in bold.

Most fonts exists in four different versions in the LaserWriter: plain, italics, bold, and bold italics. Not so Symbol. It exists in only a plain version. But if you use the Italics style you get Italics on the LaserWriter. I presume that the plain LaserWriter version of Symbol is slanted by the software, just as the screen fonts.

You would then suppose that the same strategy would be used when printing bold on the LaserWriter. But no, if you use bold or bold italics you get plain or italics respectively on the LaserWriter. At the moment I try to get round this by fooling the LaserWriter. I have made a copy of the Symbol screen font that I have renamed Symbo2. I use this font when I need bold Symbol characters. This font is not recognized by the system, and the software then does what it is supposed to do when not recognizing a font; it uses the screen font to print on the LaserWriter. And, voila, I get bold and bold italics Symbol on the LaserWriter.

But there are drawbacks. The extra copy of Symbol takes up space and clutter up the menus. The printing quality is not very good either.

Is there anyone who knows of a solution to this dilemma?? I guess there are a lot of frustrated mathematicians and physicists out there, wondering why Apple won't allow them to use greek letters for vectors.

Anders Liljegren,  
Uppsala University,  
Sweden

From: Stuart MacFarlane  
Subject: **Japanese word-processing** - summary of responses

Thanks to a number of people who sent me information on Japanese word processing on the Mac. As promised, here is a distillation:

KanjiTalk is the Macintosh Operating system in Japanese (Kanji). Menus and the Finder, etc. are all in Kanji.

Contact: APDA  
Apple Computer, Inc.  
20525 Mariani Avenue,  
Mail Stop 33G  
Cupertino, CA 95014-6299

The only Japanese word processor that was mentioned is EGWord. People seem to think that it works OK. It resembles Word. Available from:

Qualitas Trading Co (6907 Norfolk Rd, Berkeley, CA 94705) for US\$499 (ouch!), or from:

Ergosoft Corporation  
5F Taneda Building  
1-2-5, Moto-Akasaka  
Minato-ku, Tokyo, 107, Japan  
Phone: +81-3-478-2234 for Yen59000.

Discounted prices may be available in Japan - a helpful correspondent is checking.

There is some confusion about whether EGWord works with or without KanjiTalk - it seems to depend on the version number of EGWord. I'm still working on this...

I am warned that EGWord works best with system 4.2, and sometimes crashes on exit on system 6.0.2. I am also warned that extra RAM might be needed. I am advised to consult technical note #138, and to subscribe to a mailing list called JAPAN; I haven't done either yet...

I haven't yet contacted the above addresses, so I can't fill in the details. Mail me in a few weeks if you want more up-to-date information.

Stuart MacFarlane  
Heriot-Watt University,  
Chambers Street,  
Edinburgh EH1 1HX  
Tel: 031-225 8432 ext19

From: Bill Goffe  
Subject: **Voice Recognition For the Mac**

Some time ago there was a request for voice recognition devices and software for the Mac. In the Feb. 5, 1989 New York Times on p. 10F there was an article dealing w/ such a device. It is made by Articulate Systems Inc. of Cambridge, Mass, (617) 876-5236.

Their Voice Navigator can be used to recognize as many as 200 words at each level of a command (?). They note that it can be used w/ paint and cad programs to call for special tools rather than constantly using a mouse. Sounds handy to me. The cost is \$999. They say it will be available in the second quarter.

Bill Goffe

From: Jeff Meyer  
Subject: **Jasmine's Directprint**  
Greeny writes: >Has anyone out there used, or heard anything good/bad about Jasmine's new "laserprinter" the DirectPrint? Problems, advantages, etc... <  
There was a demo of it the other night at the Seattle Mac dBUG meeting. I can give you a breakdown of it's good/bad points (mostly from calling and talking to Jasmine - the presentation was one of the worst I've ever seen. More on that later...).

GOOD:

- \* Runs at about the speed of a LaserWriter II NTX, but at the price of a LW II NT. RISC architecture is the reason.
- \* Uses a liquid crystal shutter - no rotating mirrors. Sharper, clearer images (we tested a few things, and this seems to be the case, though the difference wasn't as apparent to me as it was to some of my companions who are graphic designers).
- \* Very lightweight and small.
- \* Standard LaserWriter font set comes with it (though they're not made by Adobe, they're Bitstream fonts).
- \* "100% PostScript Compatible" We didn't get a chance to test this with some complex SuperPaint documents, but they were taking all comers up front, and nobody's stuff bombed.

BAD:

- \* Doesn't work with Adobe downloadable fonts. This is supposedly one of the reasons things are so cheap - no Adobe licensing fees. This isn't a problem if you haven't invested in Adobe Font libraries (Bitstream makes the same fonts for a good deal less \$\$, I understand from my G.D. friends), but if you \*have\* bought into Adobe, it's a major drawback.
- \* Doesn't work with labels, transparencies or envelopes, according to the Product Manager, just standard size paper (I don't know about legal size, though).

\* It's "new technology", i.e. the first one of the bunch. This wouldn't worry me, but...  
... the presentation that the Product Manager gave was so apologetic that I was wondering whether this thing was buggy or not (he described it as "the Mac 128K of LaserWriters", and kept talking about a) the bugs they'd had in developing it and b) how they were working hard on the second generation of LQS laser-printers). Two co-workers from Fluke who had come to see the demo, and were thinking of buying one, didn't come away with a very comfortable description of the product, and they both purchased Apple LW II NTs the next day...

So I guess the conclusion is that it seems to be a very nice box for a lot of people's needs, but from the presentation (and the presentation alone - it seemed to be working alright), I'm a bit nervous about the machinery.

Jeff Meyer

From: Jakob Nielsen Tech Univ of Denmark

Subject: **Wingz unsmooth contour charts**

Does anybody know how to get completely unsmoothed contour charts in Wingz? I have tried to select the object/chart info command and unchecking smooth, but it still seems to do some kind of interpolation of the values. A related issue is that the legend contains patterns for a continuous range of values while my data only has three discrete values. I want a contour chart which retains one square for each point in the original data.

From: Jakob Nielsen Tech Univ of Denmark

Subject: **Wingz user interface problems**

I bought Wingz a few days ago and discovered the following user interface problem while trying out the program:

I had generated a bar chart and tried to change the scale of an axis: Select the axis and choose the Axes>Scale Info... command from the Graph menu. Unfortunately I entered some erroneous numbers into the resulting dialog box which meant that upon clicking OK, my chart disappeared and was replaced with the error message Scale min must be < max. This message is fine in itself (pre-

cise, not condemning of the user error, and almost constructive) but unfortunately it overpaints the entire graph area. Now, if I had immediately reissued the Graph>Axes>Scale Info... menu command, my axis would still have been selected and I would have been able to change the scale min value. However (like the stupid user I am) I panicked and clicked elsewhere first before going to the menu. This meant that the axis was no longer selected and therefore could not be changed. And since the error message overpaints the entire graph area, I could not click on the axis to select it...

As a result, I was now in a user interface deadlock, where I could not select the axis to remove the error before the error had already been removed; but at the same time I could not remove the error without selecting the axis first.

Another problem is not so much a user interface problem for the interactive user of Wingz as is a user interface problem for the "user" of the information generated by Wingz (e.g. a reader of output >From the program).

The problem is that you can generate graphs containing several pie charts which are then scaled relative to the size of the values they represent. All very nice until you realize that the scaling is done by making the "radius" of the circles proportional to the underlying values rather than making the "areas" of the circles proportional to those values. Of course anybody with a minimum understanding of geometry will immediately realize that this means that the areas of the pie charts are proportional to the "square" of the underlying values. Usually it is the area of a circle which is used to estimate its "worth" by eye (just consider how you would estimate how many people could be served >From a real pie) and this again means that the graphs generated by Wingz can be misleading for the casual, non-mathematician viewer.

From: Chris Iverson

Subject: **'Sad Mac' codes defined**

The following is excerpted from an article that originally appeared in "Apple Direct" magazine.

> On the old ROMs: When you hit the interrupt button on the side of

your Macintosh during the boot process, you should get a sad Mac icon with OF 000D and some dots cycling under the icon to indicate that the Macintosh is performing a memory test. \ This numeric code is in two parts: The first two characters are the "class code" and the next four are the "subclass code". The class code tells what part of the diagnostic program found the error, and the subclass code tells what the error is. In the case of a bad RAM chip, the subclass identifies the bad chip.

> On the new ROMs: The sad Mac error codes are changed to incorporate additional power for testing and to support a 32-bit world. Generally, the same codes are used...but they are displayed differently. The traditional Mac error codes are displayed as follows: OF0003 Where "F" indicates an exception occurred, and "3" indicates an illegal instruction occurred. On the SE and II family, the display would appear: 0000000F 00000003 The new power-on error codes have the following format: XXXXYYYY ZZZZZZZZ Where XXXX is the internal test manager state information (ignore this), YYYY contains codes that indicate either an exception code or the test number for a power-on test failure. The ZZZZZZZZ code contains additional failure info to help track down the problem.

YYYY error codes:

\$0001: ROM checksum test failed. Ignore Z field.

\$0002: First small chunk of RAM tested failed. Z field indicates which RAM bit(s) failed. This chunk of RAM is always in bank B.

Example: \$AABBCDD

AA=8-bit mask for bits 31-24

BB=8-bit mask for bits 23-16

CC=8-bit mask for bits 15-8

DD=8-bit mask for bits 7-0

\$0003: RAM test failed while testing bank B, after passing the chunk tested for \$0002. Z field indicates which bits failed, as in code \$0002.

\$0004: RAM test failed while testing bank A. Z field same as for \$0002.

\$0005: RAM external addressing test failed. Z field indicates the failed address line.

\$0006: Unable to properly address the VIA1 chip. Ignore Z



field.  
 \$0007: Unable to properly address the VIA2 chip (Mac II only). Ignore Z field.  
 \$0008: Unable to properly address the Front Desk Bus. Ignore Z field.  
 \$0009: Unable to properly address the MMU. Ignore Z field.  
 \$000A: Unable to properly address NuBus. Ignore Z field.  
 \$000B: Unable to properly address SCSI chip. Ignore Z field.  
 \$000C: Unable to properly address the IWM chip. Ignore Z field.  
 \$000D: Unable to properly address the SCC chip. Ignore Z field.  
 \$000E: Failed Data Bus test. Z field indicates bad bit(s) as a 32-bit mask for bits 0-31. This error may indicate a bad SIMM or data bus failure.  
 \$000F: Reserved for Macintosh compatibility.  
 \$FFxx: A 680\_\_ exception occurred during power-on testing. The xx indicates the exception:  
 \$01 Bus error  
 \$02 Address error  
 \$03 Illegal instruction error  
 \$04 Zero Divide  
 \$05 Check Instruction  
 \$06 cpTrapCC, Trap CC, Trap V  
 \$07 Privelege Violation  
 \$08 Trace  
 \$09 Line A\  
 \$0A Line F (the backslash on the previous line is a typo)  
 \$0B Unassigned  
 \$0C CP protocol violation  
 \$0D Format exception  
 \$0E Spurious interrupt  
 \$0F Trap 0-15 exception  
 \$10 Interrupt Level 1  
 \$11 Interrupt level 2  
 \$12 Interrupt level 3  
 \$13 Interrupt level 4  
 \$14 Interrupt level 5  
 \$15 Interrupt level 6  
 \$16 Interrupt level 7  
 \$17 FPCP BRA orSET on unordered condition  
 \$18 FPCP inexact result  
 \$19 FPCP divide by zero  
 \$1A FPCP underflow  
 \$1B FPCP operand error  
 \$1C FPCP overflow  
 \$1D FPCP signalling NAN  
 \$1E PMMU configuration  
 \$1F PMMU illegal operation  
 \$20 PMMU access level violation  
 There you have it folks: Everything you always wanted to know about sad Mac error codes, but didn't want to be bored to death reading about. I hope this is helpful.

Chris Iverson F&M Tech Support  
 Disclaimer: I'm just a grunt, don't take me seriously...

From: "Sandro Corsi"  
 Subject: **Thunderscan resolution**

We use Thunderscan quite heavily, and for its price it gives us amazingly competent results. The scanning resolution can be varied by changing the magnification of the image being scanned. Magnification ranges up to 800%, but the manual cautions that beyond 400% Thunderscan is not really reading any more detail in the image, just interpolating. At any rate, scanning at 400% and printing at 25% magnification still works out to a respectable 288 dots (\*samples\* would be more appropriate) per inch spatial resolution. And you also get 5 bits of gray-scale resolution (32 grays). The scanned image can be saved in Thunderscan's own SCAN format (which can be imported directly into such programs as ImageStudio), TIFF, and EPSF. If gray-scale information is not important, and all you need is a bitmap, then also PNTG (MacPaint) and PICT formats are available. As far as I could determine, PICT2 is not supported — though it might be because we have it hooked up to a MacSE (no Color QuickDraw ROM support). On the down side: - Sloooow: a full page at 400% magnification could easily tie up your ImageWriter for the better part of an hour. There's no workaround — the limit is in the mechanics of the printer. - Again because of all the mechanical going-ons, there are minor mis-alignments of scanlines. Also, you have to nurse the printer-turned-scanner for the first few lines until it settles down and you are satisfied that it is not pouring scrambled garbage into the Mac. The "edge sensing" 1/2 inch wide white stripe on the LEFT is critical to proper operations, and works best if it is directly incorporated into the image to be scanned. Other limitations on image size are due to the need to get the top of the picture underneath the paper bail (approx. 1" margin, TOP), the need to have the paper firmly pressed against the platen until the end of the scan (1/2" ca., BOTTOM); and TS's penchant for scrambling the image if it is made to scan the entire

width of the sheet of paper (1/2" ca., RIGHT). The manual says that TS will also work with a wide-carriage ImageWriter, but I haven't had a chance to verify that claim. - Apple turned the cards several times on TS with respect to its power requirements. In the pre-Plus Macs, the serial ports provided enough power on one of the pins to power TS. That was eliminated from subsequent Macintosh models, and TS therefore came up with an ungainly contraption (included in the price of purchase) which draws power from the external drive port (the port is still available for its intended purpose — connecting floppy drives). Since such a port is missing from the II and IIX, to use TS with those Macs you need an extra-cost power accessory (that's why we have our TS plugged into an SE). I have no idea, as of this writing, how things might once again change with the IICX external drive port. - I hoped that the scanner would work through our ImageWriter's AppleTalk card interface, and be visible across the network. Nice try, but... I guess it would have been asking too much from such a simple thing. - We've had problems scanning at 400% and saving as SCAN. ImageStudio will not interpret the files properly. However, if the same image is saved as TIFF there are no problems — and I couldn't determine who's to blame, TS or ImageStudio.

Hope all this helps. Best regards.  
 Sandro Corsi  
 Art Dept.  
 Univ. of Wisconsin - Oshkosh  
 Oshkosh, WI 54901

**Info-Mac** digests consist of submissions by individuals on the academic computer networks. Submission and distribution of these digests is by network, moderated by volunteers at Stanford University.

**Usenet** is a loosely-coupled network of co-operating academic and commercial computer systems. It is a non-profit network whose primary aim is the sharing of technical information and the spreading of research results.

**Delphi** is a commercial time-sharing and bulletin board system. The Delphi Digests are made available thanks to Jeffrey Shulman of Rutgers University.

# CheapColor

## A useful utility by Jeff Skaistis for users of the ImageWriter II

### Introduction

CheapColor is a utility that converts PICT2 and PixelPaint documents into a format that allows them to be printed in color on an ImageWriter printer with a color ribbon. Also, it can save these in a format that can be used by applications that support the original eight QuickDraw colors, such as SuperPaint, and they should display correctly on a ColorVue SE system. It will work on a Plus, SE, SE/30, II, or IIX system.

### How It Works

CheapColor breaks down an RGB image in either PICT2 or PixelPaint format into dithered overlays of the eight original QuickDraw colors. For those who never realized that the Mac ever had color before the Mac II, all versions of QuickDraw support eight colors; black, red, green, blue, magenta, cyan, yellow, and white. By dithering these colors together, a fairly accurate representation of a 256 color picture can be achieved.

### Using CheapColor

Here are descriptions of CheapColor's menu commands:

#### About CheapColor...

Shows information about the program, including the shareware notice (see below). For those with Color QuickDraw systems, there is also an example of a conversion of a 256 color picture.

#### Open PICT...

Opens a PICT file. If the file is a version 1 picture, CheapColor opens and displays the picture. If the file is a version 2 picture, CheapColor will convert it and display it.

NOTE For non-Color QuickDraw systems, the pictures will

display pretty messily since every color except white will show up as black. Also, since CheapColor manipulates PICT2 documents manually when Color QuickDraw isn't present, some documents may not load into CheapColor. This is not a problem with PixelPaint documents.

#### Open PixelPaint...

Converts a PixelPaint document and displays it.

#### Close

Closes the current window and image.

#### Save...

Saves the current image in PICT format. These documents can be opened and used by applications that support the eight original QuickDraw colors.

NOTE For reasons unbeknownst to me, even though MacDraw II supports and uses the original QuickDraw colors, it ignores any color information in PICT files it opens or pasted in to it. However, you can manually re-color CheapColor images. See below for a discussion of this.

#### Page Setup...

The usual.

#### Print...

Prints the current image. If printing on a ImageWriter with a color ribbon, it will be printed in color. If the image size is larger than the current paper size, a dialog box will come up with a miniature image and a paper outline that moves with the mouse. Position the paper rectangle with the mouse and click where you want it to print. For best results, you might want to use a little heavier bond paper.

#### Quit

See you later...

### Potential Problems

Converting a PICT2 or PixelPaint

document requires a lot of memory. If your machine has only 1 Meg., you won't be able to convert very large images. In fact, it won't be enough to convert a 512 x 512 image. Hopefully, DRAM prices will go down soon.

If the program runs out of memory, it will quit gracefully (hopefully) to avoid any other problems.

### Re-Coloring CheapColor Images

To re-color CheapColor images in MacDraw II, open the document and follow these steps:

1. Create solid patterns of the six non-B/W colors. If you can't see the colors, they are red, green, blue, yellow, cyan, and magenta from left to right.
2. The CheapColor image is made up of seven overlaid bitmaps, each representing a different color. The top one is the black overlay. Select it and choose Send To Back from the menu.
3. Select the new top image. Click on the foreground color display symbol (the one on the right side of the pattern bar) and then click on the magenta color pattern. Choose Send To Back from the menu.
4. Repeat step 3 with the rest of the colors in the following order: cyan, yellow, blue, green, and red.

### Miscellaneous

Version 1.0.1 fixes some bugs from version 1.0:

One that caused a crash while converting a PICT2 document with a non-standard CLUT on a Color QuickDraw machine running without MultiFinder.

One that caused a crashed sometimes when converting a PICT2 document without Color QuickDraw.

Version 1.02 corrects the problem in previous versions of only saving the part of the image that is displayed in the window.

Version 1.0.3 fixes a problem while converting a PICT2 on a Mac with Color QuickDraw. It had some problems with mismatching colors in pictures with more than one bitmap object.

The dithering filter used by CheapColor was developed by Daniel Burkes.

**CheapColor is available on one of this month's Macintosh Library Update Disks.** 



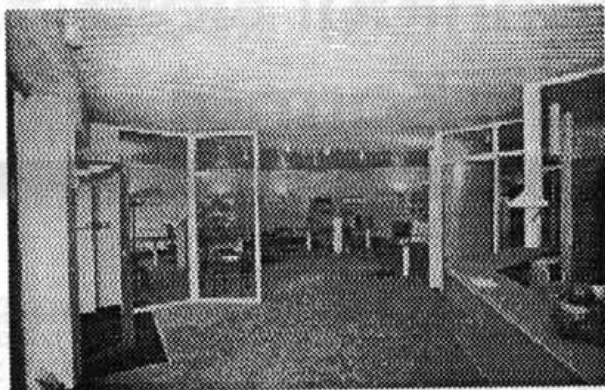

## Friendly Solutions at your AppleCentre<sup>SM</sup>

Celtip Computers has been in operation for almost ten years and in that time has built up an enviable reputation as the Apple<sup>TM</sup> Macintosh<sup>TM</sup> dealer in Worcestershire.

The Macintosh's legendary system of easily understood words and pictures simplifies its operation and with the full backing of Celtip's sales, support, and training facilities you can be sure of an efficient friendly solution. Come in for a demonstration today.

**Celtip Computers : AppleCentre<sup>SM</sup> Kidderminster**

**Lower Mill Street, Kidderminster, Worcs, DY10 2JG. Tel : 0562 822222**

Apple, the Apple logo, and Macintosh are trademarks of Apple Computer Inc. AppleCentre is a service mark of Apple Computers Inc.

# Macintosh Technical Note #227

## Toolbox Karma

**#227: Toolbox Karma**  
**Written by: Ed Tecot**  
**February 1989**

This Technical Note discusses Macintosh Toolbox compatibility and what you can do to help the Macintosh continue evolving in the future.

It is getting increasingly difficult to make additions to the Macintosh Toolbox. The single greatest obstacle today is compatibility. Often, engineering is prevented from doing something in an elegant manner because it would break some applications. This usually leaves three choices:

1. Break the application. Engineering does not normally choose this course of action.
2. Don't support the feature. This is rarely a good choice. It is bad for the user, and it limits developers.
3. Implement the feature in a less-than-optimal way. This is the choice most often taken. Examples are the auxiliary window list, faking desk accessories in MultiFinder to force clipboard conversion, and the ever unpopular menu bar definition procedure (MBDF).

Engineering doesn't like making additions in this way, since it clutters the architecture and makes Macintosh programming even more difficult.

### Rules, Rules, Rules

You're probably thinking, "But I followed the rules." You're right. You've followed the stated guidelines in *Inside Macintosh* and the Macintosh Technical Notes. You've done nothing explicitly wrong.

However, you can do **more** than just follow the rules. Consider

what effect your design decisions have on the Macintosh community. Understand that by taking advantage of a documented feature, you may be preventing the Macintosh from growing in the future. If you follow some of the following guidelines, you can give Apple some flexibility in changing rules that are no longer appropriate. These guidelines are just a sample, and hopefully you can extrapolate more from this list.

### Traps Are Here to Stay

The trap interface is the ultimate Macintosh standard. Even when data structures change, the traps always work. Use them to their fullest. Don't directly manipulate data structures when a trap call will do, don't use `_HandToHand` to duplicate a handle if there is an explicit trap call available (e.g., `_TENew`), and don't patch traps. If a trap does not work the way you want, implement your own code instead of trying to patch the required functionality into the trap. If you absolutely must patch a trap, don't make assumptions about registers (e.g., A5) or modify the stack. See Technical Note #212, *The Joy of Being 32-Bit Clean*, for more information on the evils of patching traps.

### Data Structures Are Subject to Change

Engineering won't haphazardly change them, but by using the traps, you give them the flexibility to make these changes. If everyone had been using `_SetWRefCon` and `_GetWRefCon`, the auxiliary window list might not have been necessary. Of course, if everyone agrees to use these traps and leave the auxiliary window list alone, maybe they can fix this one in the future.

### Write Robust Definition Procedures

All of the definition functions, WDEF, CDEF, MDEF, etc. have

room for growth. Do not stunt this growth by making unnecessary assumptions. If you do not understand the message, don't do anything. If a parameter is documented as unused, don't use it; it may be used in the future. These same rules apply to anything which might be called from ROM, such as drivers, user procedures, and filter procedures. Treat the MBDF as undocumented. It has changed considerably in the past and will continue to do so.

### Use Globals With Caution

Globals often have their meaning changed or their format altered. Use the trap interfaces when available (e.g., `_TickCount` instead of `Ticks`). Try to avoid using them at all if possible.

### Your Future is Apple's Future

As a developer you play a key role in shaping the future of the Macintosh. By going beyond the guidelines in *Inside Macintosh* and the Macintosh Technical Notes and considering the effects of your design decisions on the whole Macintosh community, you allow the Macintosh to grow and change while still maintaining compatibility. We won't break your applications, we can fully support features you desire, and we can implement these features in the best possible way for us, for you, and for the users. By going that extra step, you help us make programming the Macintosh simpler and ensure the best possible future for your products as well as ours.

### Further Reference:

- *Inside Macintosh*, Volume V, Compatibility Guidelines
- Technical Note #2, Compatibility Guidelines
- Technical Note #117, Compatibility: Why & How
- Technical Note #212, *The Joy of Being 32-Bit Clean*





# Macintosh Technical Note #230

## Macintosh SE/30

### #230: Pertinent Information About the Macintosh SE/30

Written by: Chris Knepper April 1989

This Technical Note discusses the Macintosh SE/30, items of interest to developers, and sources for further information.

The Macintosh SE/30 is a modification of the original Macintosh SE concept. The SE/30 combines the modularity of the original SE with the capabilities of the larger Macintosh IIx. Although the name implies that the SE/30 borrows many characteristics from the SE, there are actually substantial differences between the two machines, and this Note addresses some of those differences.

### Similarities Between the Macintosh SE and SE/30

The main similarities between the SE and the SE/30 are as follows:

- compact design
- power supply
- analog board
- rear housing
- SCSI support
- ADB support
- nine inch video display

### Differences Between the Macintosh SE and SE/30

There are, however, many differences between the two machines. This section covers those differences with respect to their impact on developers.

#### CPU

The Motorola 68030 on the Macintosh SE/30 is clocked at 15.6672 MHz and provides both 32-bit data and address buses, both 256-byte instruction and data caches, and a built-in Paged Memory Management Unit (PMMU). The 68000 in the Macintosh SE is clocked at 7.83 MHz.

Although the 68030 is capable of a burst mode to more efficiently access contiguous blocks of memory, this feature is not enabled on the Macintosh SE/30. Enabling this feature would require significantly more complex control logic and faster (read "more expensive") RAM.

#### Coprocessor

The Motorola 68882 on the Macintosh SE/30 offers a full implementation of the IEEE Standard for Binary Floating-Point Arithmetic. The 68882 has an optimized MPU interface that provides up to 1.5 times the performance of the 68881. The Macintosh SE does not ship with a coprocessor (although third-party coprocessors are available).

#### ROM

The Macintosh SE/30 ROM is identical to that of the Macintosh IIx; it includes Color QuickDraw, the Slot Manager, and other features of the IIx ROM. It is composed of four 512 Kbit ROMs, for a total of 256K, and it is mounted on one ROM SIMM (ROM SIMMs are expandable to 2 MB).

System Software 6.0.3 (and later) patches to the ROM affect the Start Manager, the OS utilities, and the Sony driver.

#### RAM

The SE/30 includes eight RAM SIMM slots like the Macintosh II family and supports from 1 MB up to 128 MB (using 16 MB SIMMs), however, the current System Software only supports the first eight megabytes of RAM. The SE/30 also supports 4 MB DRAMs. For more information on memory configuration, see Macintosh Technical Note #176, Macintosh Memory Configurations.

#### Video

The Macintosh SE/30 video architecture is compatible with the SE: one-bit per pixel monochrome display with 342 lines of 512 pixels each. There is 64K of high-speed video display RAM to maximize video performance. The video provides dual display buffers of 21,888 bytes for fast page switching; the primary buffer starts at \$FE008040 and ends at \$FE00D5C0, and the alternate buffer starts at \$FE000040 and ends at \$FE0055C0. The physical address of the video buffers simulates the NuBus address of slot \$E on the Macintosh II family.

Developers need to be cautious with this video implementation, since a call to `_SysEnviron` returns true for `hasColorQD` (since Color QuickDraw is implemented in the SE/30 ROM), but the default configuration only includes a single monochrome display.

As with any machine which supports Color QuickDraw, your application should test for the specific functionality which it needs, keeping in mind that different capabilities may be present on devices other than the main display. For example, an application which requires eight or more bits of color

may do the following:

```
gotOne := FALSE;      { Assume we'll fail }
aDevice := GetMainDevice; { Get the first device }
WHILE (aDevice <> NIL) AND (NOT gotOne) DO
  IF (aDevice^.gdPMap^.pixelSize >= 8) AND
    { Do we have >= 8 bits? }
    (BitTest(@aDevice^.gdFlags,15)) THEN
    { And are we color? }
    gotOne := TRUE
    { Yes! We're done }
  ELSE
    aDevice := GetNextDevice(aDevice);
    { Try next device }
IF gotOne THEN
  { We have a screen to use. Maybe put our
  window up within aDevice^.gdRect }
```

### Processor Direct Slot Expansion

The Processor Direct Slot (PDS) in the SE/30 is significantly different from the PDS in the SE. The 68000 PDS in the SE provides a 16-bit bus, whereas the 68030 PDS in the SE/30 provides both a 32-bit data bus and a 32-bit address bus. Access to the full 32-bit data bus allows for higher performance expansion cards than the 16-bit bus of the PDS in the SE. In addition, many of the expansion cards built for the PDS in the SE were hard-wired to the 7.83 MHz clock speed. Since the clock speed in the SE/30 is 15.6672 MHz, there are fundamental incompatibilities in clock speed, and therefore expansion card design.

The PDS in the SE/30 is a 120-pin, 32-bit PDS which provides both "common" and "machine-specific" signals. The common signals will be available across all 68030 PDS implementations, while the machine-specific signals will be available on future 68030 PDS implementations and may have new features added. On the SE/30, the machine-specific signals emulate equivalent signals on the NuBus expansion interface. This emulation means that expansion cards on the SE/30 may take advantage of the Slot Manager in ROM to communicate with the bus via a Declaration ROM on the card.

Connectors for the PDS may be obtained from AMP (part number 535022-1).

Prototyping cards for the PDS may be obtained from:

Creative Solutions  
4701 Randolph, Suite 12  
Rockville, Md 20852  
Attn: Chris Colburn  
(301) 984-0262

**Disclaimer:** This listing for Creative Solutions neither implies nor constitutes an endorsement by Apple Computer, Inc. If your company supplies these cards and you would like to be listed, contact us at the address in Technical Note #0.

The chassis design of the SE/30 simplifies expansion card installation as cards may be mounted vertically instead of horizontally, as in the SE. Because of this orientation, expansion cards can be

installed without removing the logic board. In addition, there is more room for expansion cards in the SE/30 than in the SE.

### System Software Requirements

The SE/30 requires System Software version 6.0.3 or later. Beginning with version 6.0.3, the installer shipped with the System Software includes a specific script for the SE/30.

### Internal Floppy Drive

All configurations of the Macintosh SE/30 ship with an internal FDHD (Floppy Drive, High Density) floppy drive (a.k.a., SuperDrive) controlled by the SWIM controller chip. The SWIM chip is capable of supporting 720K and 1.44 MB Modified Frequency Modulation (MFM) formats (i.e., MS-DOS 3.5" disks), as well as the 400K and 800K Group Coded Recording (GCR) formats (Macintosh and Apple II 3.5" ProDOS disks) and the 1.4 MB MFM format (Macintosh 3.5" high-density disks). Note that special disks are required to take advantage of the 1.44 MB and 1.4 MB MFM formats. These disks have a square cutout in the top left corner to differentiate them from standard floppy disks. These disks may **not** be used in standard floppy drives (i.e., 400K and 800K) in the Macintosh family.

Although the SE is capable of supporting two internal 800K floppy drives, the SE/30 only supports a single internal FDHD drive.

### External Floppy Drive

The SE/30 provides support for an external 800K floppy drive; it does not support the external 400K floppy drive or the external HD20 hard disk.

### SCSI

The SE/30 uses the same 53C80 and interface logic as the Ix. This combination supports pseudo-DMA burst transfers, and SCSI performance matches that of the Ix.

### \_SysEnviron

On the SE/30, \_SysEnviron version 2 returns 7 in the machineType field and 4 in the processor field. For more information about \_SysEnviron, see Macintosh Technical Note #129, \_SysEnviron: System 6.0 and Beyond.

### Sound

The SE/30 uses the Apple Sound Chip, rather than the discrete sound circuitry of the SE. Although the circuitry provides stereo output to the speaker jack, as of System Software 6.0.3, stereo sound is **not** implemented, so true stereo is not yet available. The internal speaker of the SE/30 uses a mixed signal from both channels, whereas a Macintosh II uses a signal from only one channel.

### Clock

The battery is not soldered to the motherboard and is replaceable.

### General

All positive 5.0 volt outputs from the SE/30 (ADB, floppy drive, SCSI) are fuse protected from over-



loads. The maximum current that an external device connected to these ports can draw is 800 mA.

#### Upgrade Kits

Apple will offer several SE-to-SE/30 upgrade kits for current SE owners in the Spring of 1989. However, installation of these upgrade kits will prevent the owner from using any current SE expansion cards.

The first upgrade kit consists of the following:

- Logic board with 1 MB RAM
- Chassis
- EMI shroud
- Ferrite bead for power cable
- SE disk drive slot cover and retainer clip (for second floppy drive, if necessary)
- Owner's Manual

The dealer performing the upgrade is required to return the SE logic board with 1 MB RAM to Apple. A separate upgrade kit is available to upgrade the internal floppy drive to the FDHD. This kit is optional, since the SWIM chip on the SE/30 logic board is capable of controlling the 800K floppy drive of the SE. However, upgraded SEs with two internal floppy drives will **not** be able to access the second drive, since the SE/30 only supports **one** internal floppy drive.

#### Software Compatibility

Apple's Product Quality and Support (PQ&S) department has tested over 100 of the most popular software packages on the SE/30 and has found that with the latest versions of these applications, 95% are completely compatible with the SE/30. Apple notified those developers whose tested packages were determined to be incompatible, and they are expected to announce upgrades in the near future.

Information on which packages were and were not compatible is **not** available, however, most of the incompatibilities were determined to be due to an application making assumptions about the hardware which were not true on the SE/30. In general, applications which call `_SysEnviron`s to determine the current hardware configuration are compatible.

#### For Further Information...

You can get further information about developing for the SE/30 from APDA. They offer the Macintosh SE/30 Developer Notes (part number M0061LL/A) for developers interested in producing hardware expansion cards, as well as a more general reference, *Designing Cards and Drivers for the Macintosh II and Macintosh SE*, (part number M7075).

#### Further Reference:

- *Inside Macintosh*, Volume V-1, Compatibility Guidelines
- Technical Note #129, `_SysEnviron`s: System 6.0 and Beyond
- Technical Note #176, Macintosh Memory Configurations.



# POWER SYSTEMS

**NEW NEW NEW**

**MAC SE-30  
68030-based MAC SE**

**CALL CALL CALL**

#### OCR System

5Mb Mac II, 28ms 100Mb int drive, Mono Monitor; Apple Scanner; OmniPage OCR software; Delivery, installation, commissioning & training

**£7175.00 + Vat**

#### DTP System

8Mb Mac II, 28ms 100Mb int drive, A3 Mono Monitor; Apple Scanner; LaserWriter IINT; Illustrator; Word; PageMaker; Delivery, installation, commissioning & training

**£12595.00 + Vat**

#### Business System

4Mb Mac SE, 40 Mb int drive, Excel, Works; LaserWriter IINT; Delivery, installation, commissioning & training

**£7250.00 + Vat**

#### Low Cost System

1Mb Mac Plus, 20 Mb ext drive, Works, HP DeskJet. (includes delivery. Training extra)

**£2695.00 + Vat**

**Bidmuthin Technologies Ltd.**  
Brent House  
214 Kenton Road  
Harrow  
Middlesex HA3 8BT

Tel: 01-907-8516

Fax: 01-907-0047

**Authorised Apple Dealer  
Level 1 Service Centre**



# Club Business

## Minutes of the Annual General Meeting of B.A.S.U.G. Ltd., April 8th, 1989.

### Minutes of the Annual General Meeting of B.A.S.U.G. Ltd.

Twenty-six members of the club were present, and a further fifteen were represented by proxy.

The meeting was opened at 11.10 a.m.

Ewen Wannop explained that the Chairman, Mick Knapp, was unable to attend so Ewen was chairing the meeting on his behalf.

### 1. Minutes of the Last Annual General Meeting held on April 9th, 1988.

The minutes of the AGM held on April 9th, 1988 were unanimously accepted as a true and accurate record of that meeting.

### 2. Chairman's Report.

Ewen Wannop, on behalf of the Chairman, began by reminding those present that at last year's AGM there had been a change of several members of the Committee. This meant that we started off with quite a challenge because Jim Panks who had put a great deal of hard work into the magazine over the previous months, was no longer with us. This meant that some new people had joined the editorial team and had to learn everything involved in putting the magazine together.

The Committee, and especially Ewen himself, had been very keen that Apple2000 should continue to support the Apple II much more strongly than it had appeared to be doing in the past. This was because a group like Apple2000 was made up of all kinds of Apple users whether their interest is basically Apple II or Macintosh and a large number of us have

interest in both machines in any case. Also a reasonable proportion of the membership do own an Apple II machine. These were all reasons why the group should continue to support Apple II and Ewen had concentrated his interest in that quarter over the year and this was reflected in the ongoing commitment to Apple II in the magazine. Ewen thought that this commitment would probably continue whatever Apple themselves did with the Apple II. There are still going to be a lot of people out there with this machine, who are using it and are going to need help and information.

This renewed commitment to support Apple II had stopped a slide away in the membership from Apple II people who thought that there wasn't enough in it for them.

The magazine is the main focus of attention for the group because it is what everybody sees. It is our flagship which we put our efforts into over the year and the Committee hope that the quality has remained high, but that was for members to judge.

Ewen thanked the Committee for the work they had put in over the previous year. Thanks were also given to Alison Davies for the work she had done, and also to her husband Mike who helped in preparing workshops over the year. Thanks were also expressed to Keith Chamberlain who had looked after the membership and Force databases quietly and efficiently all the year round. Thanks also to Dave Ward who runs the Hotline and to Tony Dart who is our new Macintosh Hotline member.

Thanks were also given to John Lee who was unable to attend the meeting but who distributes the

Apple II library, manages the Force, looks after the local group list and generally makes himself useful as well.

Ewen also thanked all the many reviewers and article writers who contributed to the magazine. There are now quite a lot of them, some stalwarts who contribute regularly and send in excellent work, and one or two who put in just an odd article here and there. All of them are absolutely invaluable and all very welcome.

Ewen thanked all the advertisers who had supported the magazine over the year both on the Apple II side and on the Macintosh side. Our magazine is now the only one supporting the Apple II to any extent in the UK.

Ewen took over the bulletin board about a year ago and he has been running it since then. A great deal of storage had been added by putting another hard disk on which had meant that there had been a great improvement in the libraries on there. The Macintosh library on TABBS had been developed and now looks very impressive and this has resulted in about double the callers in the last few weeks. Downloading facilities are restricted to members of Apple2000.

The Force, which is the service on Telecom Gold that we run, has been hit to some extent by the rising charges and access charges that have been imposed by Telecom and quite a few members have dropped off because it was no longer economical for them to keep a box going. Some new members have joined the Force and this is an area which we are going to look at during the year to try to improve it and get more people to come on as members of the Force.

Members of the Force can now send Fax's through Telecom Gold, but you cannot receive them as yet. The Fax is sent in the form of a text message, and works very well so that it is an alternative to buying a Fax machine if you need to send Fax. You can also send Telex and the Force is a very cheap way of getting onto Telecom Gold.

The Libraries which we run have been developed over the year. The Macintosh Library continues to grow in Norah's able hands. The IIGS Library has been revamped over the year and new



disks put out. There are twelve disks now, and it will continue to expand. The Apple II side is still being looked at and it has been a problem for one or two years. There are getting on for two hundred disks which are getting long in the tooth and the job of going through such a large number of disks of ageing Apple software, and the time to sift through with the knowledge to know what you are doing means that it has been impossible to find somebody to do it up to the moment. We intend in the long run to trim it down but in the meantime we will republish the catalogue for it so that everyone knows what is there.

Ewen made a special mention of the Swedish Apple User's Group who have contributed some articles to recent magazines. Links have developed with them through the bulletin board because they are in isolation because Apple Sweden do not support the Apple II.

There is no recent news of the Apple User Group Council, it seems to be dormant. On the Apple UK front, they of course have now moved from Hemel Hempstead and they seem to have no direct interest in being in touch with us. It appears that the end user is not a high priority with Apple UK.

We had a presence at the MacUser Show last year with tremendous success, far better than we had ever had before. Those who visited the Show will know that we could not move on our stand for three days, it was so busy and we took a record number of members at that Show. If those on the stand had not been so exhausted we could have doubled the number joining.

In the coming year, which is largely up to the new Committee, we want to develop from the position we are at. We are going to be increasingly in isolation in supporting the Apple II but it is an important service to members that we must continue. On the Macintosh side there will be a lot of changes still to come, new machines to come, and it is rumoured that in two year's time the Macintosh itself will be replaced by yet another machine which is further along the development line.

We will try to take all these developments in our stride as we come across them. We want to expand the membership so that we can give an even better service to our members. The more members we have, the more we can draw on their expertise in writing articles for the magazine, and we would like all members to feel that they can contribute in some way.

### 3. Secretary's Report

Members will perhaps recall that at the end of the last AGM the Committee consisted of only four members. This was the result of the previous Chairman choosing to resign on that day without any prior notice of resignation in writing. This may have given rise to doubts in the mind of a few people as to how things would go during the next few months. However, it is now clear that in actual fact the past year has been one of the most settled and productive years for the Committee for some time.

Immediately after the last AGM, the four members of the Committee, of whom only Irene and myself had served before, were given offers of help from Mick Knapp and Ewen Wannop.

Mick Knapp offered his services as Chairman, and at the first Committee meeting after the AGM, Mick was co-opted onto the Committee as Chairman, and he has worked very hard for the club during the year. Sadly, he has now offered his resignation, so he will not be standing for reelection to the Committee. The Secretary will be writing to Mick in the fullness of time to thank him for stepping in at that point and undertaking to be Chairman. It was a very difficult point at which to take over and he undoubtedly helped a great deal at that time. So many thanks to Mick for all his help.

Also immediately after the AGM, Ewen Wannop offered his services and he was also co-opted onto the Committee at the first Committee Meeting after the AGM. Ewen has put in a great deal of work on TABBS and as a member of the editorial team and also as a Committee member.

Tom Wright also expressed a wish to rejoin the Committee after the last AGM and he was co-opted onto the Committee at that same first meeting. Unfortunately, during the year things did not go

as planned for Tom and he tendered his resignation last September. The parting was extremely amicable and we were very sorry to see Tom leave the Committee and he has been missed. We would all like to wish Tom good fortune and health and thank him for all that he has done for Apple2000 over the years.

The other member of the Committee who resigned during the year is Ken Hegarty. It is a very brave thing to do to offer one's services to a Committee like ours when one is in retirement. After a few months on the Committee Ken felt that he was unable to contribute to the running of the group in the way he had envisaged himself doing when he joined the Committee. Regrettably this led to him resigning, but again the parting was very amicable and I would like to thank Ken for offering his services at a time of great need.

During November, John Lee, who had helped the club in various ways for a long time, made it clear to us that he was willing to come on to the Committee. As John is disabled, he knew that he would not be able to attend meetings that were not near his home. This did not mean that John could not make a valuable contribution to the running of the Committee, as we all knew of the quality of his work. John was co-opted onto the Committee at a Committee Meeting on November 27th last year. He has taken more and more work on for the group as the year went by and it only seemed right to us that John had a say in the running of the group.

None of these comings and goings from the Committee had been contentious and the Committee had had a very settled run of meetings this year.

Thanks were given to all those who take time off from work to help at shows. Their hard work had resulted in many new members, and more members again had joined as a result of a mailshot carried out roughly at the same time as the MacUser Show.

A personal thankyou was given from the Secretary to Sak Wathanasin who helps unfailingly throughout the year in supplying public domain software for the group.

#### 4. Treasurer's Report

The accounts had been sent out to all members of the club and the Treasurer hoped that all those present had taken the opportunity to read them.

The overall financial position at the end of the last financial year was that there had been a slight increase in the surplus. We are not a profit making organisation, that is, we do not aim to make a profit but aim to cover our expenditure and try to be self-sufficient. We do not really want to make a profit as it would affect our tax position.

The membership subscriptions actually went up last year over the previous year as the number of members was slightly higher. The position is still that we find only about a two-thirds of our members renew at the end of each year. We do not know why we have this dropping away and we keep on trying to find the reason. We do get some feedback from people who do not rejoin but not a great deal.

The sales to members of disks, public domain software and special release actually went down during the year. The Apple II sales of disks and special release fell particularly and this was probably due to the fact that they had not been replaced for some time or catalogued for some time.

Another major source of income is the advertising which Alison Davies now handles for us. That actually went up during the year in question. Several people have said that the income from the advertisers should cover the cost of the magazine, and it would be very nice if it did, but it would be unrealistic to expect it to do that.

The previous financial year we actually made a slight loss on the Force, but during the last financial year we actually made a small surplus. We will have to consider whether we are justified in keeping on running the Force as the number of members using it is dropping and we do not get very many new members using it. This means that we do subsidise the running of the Force, although it is not the only service to members that we subsidise, and it is a service where we can say that the members who do use it, want it. It will remain an area that we must keep on reviewing because it takes up a great deal of time and

effort in keeping up the database, putting out invoices and chasing debtors. Thanks must be recorded to Keith Chamberlain who looks after the Force Billing and the membership database. I would not be able to manage without his help.

The overall costs for the year we do try to keep as low as possible. Committee expenses are one area which has gone down. The auditors fee goes up every year and every year we question it. This time it apparently increased from £1000 to £1500. This gives a slightly false picture and it should be an increase from £1200 to £1500 as the previous year's fee was reduced.

I have no further comments to make on the accounts but I would like to thank everyone who has helped me out during the year, including Alison, Keith, Norah and Ewen. Thanks to Dave Flaxman who has helped to answer many letters from the P.O. Box during the year.

At this point the Treasurer asked for any questions from members.

Mike Dawson queried the payment to Jim Panks of money concerning his machine and also the payment of an honorarium to him after he had left the committee.

It was pointed out that members of the committee had until recently used their own machines to carry out their committee work and if that workload was heavy then the machines reached a state of disrepair and had to be put right quickly. Norah Arnold said that her own machine had been used almost entirely for Apple2000 work since it was purchased and it was entirely understandable to the committee that Apple2000 should help to keep a person's machine in working order when that machine was used to benefit the group. The Treasurer hoped that members did not object to this being done.

The question of the honorarium was slightly different in that it was a one-off payment to Jim Panks which he had requested. Ewen Wannop said that most committee members were happy as long as they were not out of pocket because of the use of stamps and stationery, etc. and as far as the honorarium was concerned, there were no plans to do it again.

A comment was made by a lapsed member who was present, to the effect that he would think that most members would agree that if a person's own machine was used for club purposes to the point that it needed repair then Apple2000 should bear the cost of that repair.

The Treasurer made it clear that this had been accepted in principle for some time and that the Committee were aware of the problems of people who use their own machines for club purposes.

#### 5. Adoption of Accounts

Seth Proctor proposed that the accounts be adopted and this was seconded by Ron Thompson. The accounts were accepted unanimously.

#### 6. Election of Officers

Before the Committee officially retired Ron Thompson said that he would like to thank the Committee for all that they had done, they had kept the standard of the magazine up and even improved it.

The Secretary said that fifteen members were represented by proxy.

One nomination had been received for Chairman in the name of Ewen Wannop.

One nomination had been received for Secretary in the name of Norah Arnold.

One nomination had been received for Treasurer in the name of Irene Flaxman.

Nominations for Committee Members had been received in the names of John Lee, Roy Wainwright, and Keith Rookledge.

Ron Thompson proposed that all the nominations be accepted and this was seconded by Seth Proctor. The proposal was accepted unanimously.

#### 7. Any Other Business

Seth Proctor asked why the group had not had a stand at the PCW Show.

Ewen replied that there had been some confusion over whether or not we were members of the ACC and there was also confusion within the ACC as they changed to become the BACC. The outcome was that we were too late to get a stand at the PCW Show which we



regretted, but were forced to accept.

Seth Proctor asked why the AGM was held so far away from the end of the financial year, as the accounts now seemed out of date. There was some discussion between the Treasurer and Seth regarding the timing of the accounts, Seth having asked why they were so late. Seth then made the point that the reappointment of the auditors should be made dependent upon timely presentation of the accounts.

Seth also asked that the advertising of the AGM be improved. Ewen said that the Committee were aware of a conflict between their desire to get 'new blood' onto the Committee to ease the workload, and their fear of opening it up to inexperienced people who may be more of a burden than a help. It was something that could be improved.

Tony Christy said that Apple2000 was the life-blood of many members and he thought that we should publicise the fact that we were willing to help beginners on the Apple II.

Bryn Jones said that he had noticed a decline in the bulletin board activity on the Force, and asked whether the Force was mainly used by business users. In reply it was said that many users of the Force were small business.

Bryn pointed out that the many overseas members of Apple2000 could come in better on the Force via PSS than by dialling TABBS. Bryn also asked about putting the Force on MicroLink. Ewen replied giving reasons for not doing this and making the point that having our own PSS node was too expensive.

Bryn then described his experiences with the Matrix database and the Committee promised to look into this.

As there was no further business the meeting closed at 12. 15 p.m.

**The Committee would like to thank all members who attended the AGM, or who participated by sending in their proxy.**

# The Programmer's Online Companion

This very useful programmer's aid is reviewed by John Arnold.

## THE PROGRAMMER'S ONLINE COMPANION

The Programmer's Online Companion Version 2.0 written by Steve Capps is issued by Addison-Wesley in the form of a non copy-protected disk and a 24 page manual. The object is to provide for programmers the essential contents of the Macintosh "Bibles":- Inside Macintosh, Volumes I - V, and also the Apple Numerics Manual, in the form of an online database, which will be available for reference when needed by a programmer within their usual editing environment. On the disk as supplied are the following programs:- (i) Installer, (ii) Online DA, (iii) OnBase, (iv) Textbase (v) Merge.

The disk provides two methods of installing the database. The first is to drag the OnBase icon into the System folder, launch the Installer application, then Quit. The Macintosh will then reboot, and Online Companion is then

available when required simply by Typing Cmd/ ~. A window appears at the foot of the screen containing the OnBase icon. Typing "a", for "aardvark" (what else could you possibly have expected to appear on typing "a"?), gives the online Companion's command list. There are seven command / key options, the one for bringing the Online window up, the others being :- Cmd/Tab ..selects the next word in the entry, Cmd/ Shift Tab ..selects the word to the left, Cmd/Enter ..puts the selection into the cursor position of the application being run, Cmd/. and Cmd/, .. Forward or Backward to next entry in OnBase, Cmd/] and Cmd/[ .. jumps to and back from the selection's entry in OnBase. Alternatives to some of these involve clicking on a word to select it and if the Cmd key is down the chosen word will be typed into your editor. Double clicking on a word will bring the information relating to that word into the

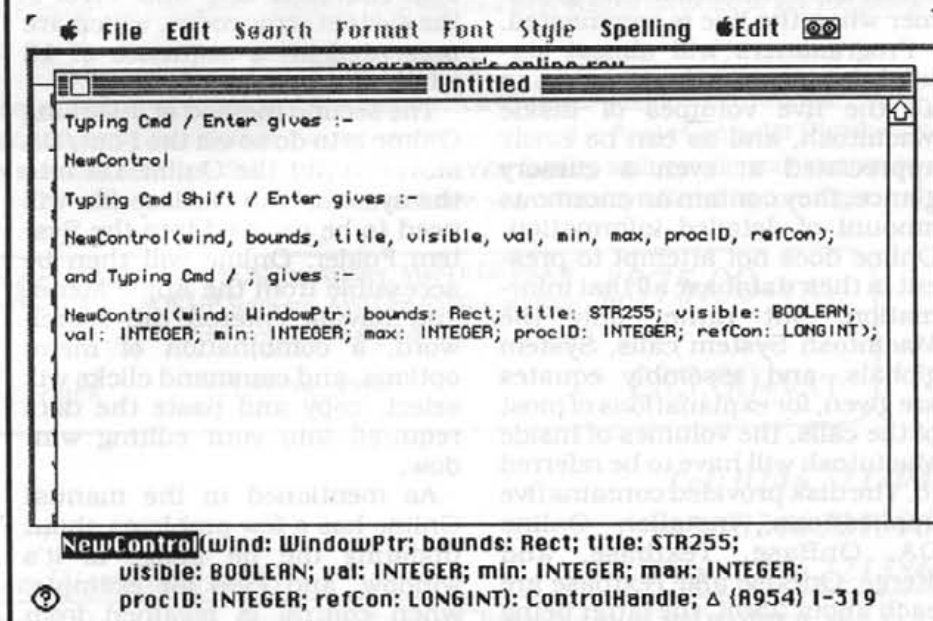

```

ModalDialog(filter: ProcPtr; VAR itemHit: INTEGER); Δ {A991} 1-415
    filter(dlg: DialogPtr; VAR evt: EventRecord;
        VAR itemHit: INTEGER): BOOLEAN;
    Return itemHit/TRUE when you handle event
  
```

The screen shown above is a typical Programmer's Online Companion Screen presentation for a procedure showing parameters. The Δ indicates that the call causes heap movement, the trap number follows, together with the volume and page of Inside Macintosh where more detail can be found. Below is part of the listing of Macintosh system error codes.

#### Error Codes (part 7 of 13)

-300 FED4 smEmptySlot	-301 FED3 smCRCFail
-302 FED2 smFormatErr	-303 FED1 smRevisionErr
-304 FED0 smNoDir	-305 FECF smLWTstBad
-306 FECE smNosInfoArray	-307 FECD smResrvErr
-308 FECC smUnExBusErr	-309 FECB smBLFieldBad
-310 FECA smFHBlockRdErr	-311 FEC9 smFHBlkDispErr
-312 FEC8 smDisposePErr	-313 FEC7 smNoBoardsRsrc
-314 FEC6 smGetPRErr	-315 FEC5 smNoBoardId
-316 FEC4 smIntStatUErr	-317 FEC3 smIntTbIUErr

### Two Programmer's Online Companion screens

Online window, option-click jumps back to the original selected word. Two further continuations of the "aardvark" information give details of the notations and conventions used in the database. In fact not all the Command keys are listed, the manual gives Cmd / ; .. which will copy the selected procedure or function with all the necessary parameters plus their types, the later can then act as a reminder to the programmer when the line is commented.

Programmers will almost certainly possess, or have access to all the five volumes of Inside Macintosh, and as can be easily appreciated at even a cursory glance, they contain an enormous amount of detailed information. Online does not attempt to present in their database all that information, but rather only the Macintosh System calls, System globals, and assembly equates are given, for explanations of most of the calls, the volumes of Inside Macintosh will have to be referred to. The disk provided contains five applications, Installer, Online DA, OnBase, Textbase, and Merge. OnBase and Textbase are each about 250K, the latter being

the text source of the OnBase file. Any information not available in OnBase that the user thinks might usefully be made available, can be entered into the Textbase, which can then be reprocessed to the indexed form, which is in fact OnBase, by clicking on the Process Database button from within the Installer.

Also available from within Online on typing Ascii :- the Macintosh character set, and error :- the system error codes, which are presented on a sequence of 13 windows.

The second method of installing Online is to do so via the Font/DA Mover to put the Online DA into the system. The OnBase file will need to be dragged into the System Folder. Online will then be accessible from the Apple Menu, and having entered the search word, a combination of menu options, and command clicks will select, copy and paste the data required into your editing window.

As mentioned in the manual Online has a few problems about updating the bit image of it's window, and Pyro for example, when control is regained from

that program, will leave the Online window as a black rectangle. Clicking in the menu bar will remove the Online window, and the editor's window will be redrawn as usual.

Online should prove to be a valuable addition to the programmer's armoury, and should save some considerable time, that would otherwise have to be spent in searching the many volumes of Inside Macintosh, in order to obtain the required information. 🍏

info

Product : Programmer's  
Online Companion  
Publisher : Addison-Wesley  
Available from : Apple2000

Price : £51.69 inc. VAT.

Value : 🍏🍏🍏🍏  
Performance : 🍏🍏🍏  
Documentation : 🍏🍏🍏



# MACINTOSH

Removable Hard Disk Storage With All The Extras

## Announcing Microtech's R45 Cartridge Drive

- **RELIABLE** *Unprecedented two year limited warranty on drive mechanism.*
- **POWERFUL** *Unlimited storage capacity.*
- **FAST** *25mS access time.*
- **COMPLETE** *Software, 2 cables, SCSI terminator, cartridge and documentation.*
- **CONVENIENT** *Allows mounting of volume without "restart".*
- **SAFE** *Removable cartridge allows for maximum data security.*
- **VERSATILE** *Provides universal solution for mass storage, data backup or both.*
- **ECONOMICAL** *Unbeatable cost per megabyte.*

### Performance:

The Microtech R45 provides 42.7 Megabytes formatted capacity on a removable hard drive cartridge. Ultimate storage capacity is limited only by the number of cartridges you wish to purchase. The Microtech R45 provides fast 25 milli-second access time and comes with an easy to use utility program that formats cartridges, installs the device driver and allows mounting of a volume without having to hit restart. The removable cartridge can be safely stored for security purposes, easily transported between desk tops and even posted to remote locations.

### Features:

The Microtech R45 comes with dual SCSI ports for daisy chaining up to six additional devices, external fuse protection, easy external push button SCSI address selection and an auto switching power supply allowing use right around the world. Each unit comes with a 25/50 pin SCSI cable, a 50/50 pin SCSI cable and an external SCSI terminator for complete installation in any configuration. Plus one 45 Megabyte cartridge preformatted with system software to get you going.

### Price:

The Microtech R45 is available at little more than a standard non-removable hard disk, the cost of cartridges is competitive with buying endless numbers of floppy diskettes

### Flexibility:

The Microtech R45 can be used as a hard drive solution or a backup alternative. Either way, Microtech provides the software utilities to maximise the drives performance. MacTREE Plus hard disk management software offers efficient tree-structured lay-out, powerful search utilities and customization capabilities. DS BACKUP lets you backup your hard disk file to diskettes, a hard disk volume or another removable drive cartridge by selective, full or incremental backup at transfer speeds faster than many tape drives. A variety of public domain software is also included with each system.

### Warranty:

The Microtech R45 comes with full UK two year mechanism warranty supported in Acme Computer Distribution Co.'s own service facility with on-site maintenance optional, with one year warranty offered on cartridges.

**Microtech R45** SCSI Cables, SCSI Terminator, MacTREE Plus & DS BACKUP Software, And One 45Mb Cartridge Pre-formatted Ready For Use. **£875.00+VAT**

Additional R45 cartridges (£1.99/Megabyte) **£85.00+VAT**

**Tel: 0246 221394**

**0246 221396**

**Fax: 0246 221386**

the **ACME** Computer-Distribution Co.

Acme House • 2A Sheffield Road • Chesterfield • Derbyshire • S41 7LL

# Mac Library

There are four new Update Disks this month.

## 908 Update 8

### HyperCard Intro 1.1

This is a HyperCard stack to be used in teaching introductory HyperCard seminars. It contains an underlying help system describing what each card is for.

### Disinfectant Version 1.1

This is a new release of a program to detect and remove Macintosh viruses. Version 1.1 recognizes the new MEV# virus that was discovered in Belgium a few weeks ago. Version 1.1 also fixes a few bugs and adds several new features. For a detailed list of all the changes see the new section titled "Version History" in the online document.

### BackIt 3.03 - Preselective Backup Utility (was P.S.B.U.)

Some file copying code rewritten. Better error detection. Possible to create folders from inside the application. BackIt is distributed as shareware.

### Gatekeeper 1.1

Simply put, GateKeeper attempts to make it impossible (or as difficult as possible) for viruses to spread or function successfully in its domain. It does so by monitoring and limiting access to certain system operations on which viruses depend. Thus GateKeeper is a general purpose tool in the fight against viruses, as opposed to programs written to stop only a specific virus or set of viruses.

### N-Font

N-Font is a FreeWare application from OLDUVAI Corporation. It allows users to easily convert the older FONT screen fonts to the newer NFNT screen fonts.

### Staircase 1.0.3 INIT

This is version 1.0.3 of the Staircase CDEV/INIT by Eccentric Software. Staircase allows you to select menus and menu items from the keyboard, similar to the "WalkDown Menus(tm)" feature of FullWrite Professional. Place the INIT into your System Folder and restart to activate.

### AnonWare Folder

This contains three HyperCard games from AnonWare: Boggle, Hi-Lo and Dingbats.

## 909 Update 9

### myPageSetup

This is a freeware application by D.G. Gilbert of DogStar Software that allows you to set up default values in Page Setup dialog for your particular printer.

### PictDisplay DA

This is the PictDisplay DA, a shareware DA by Neal Trautman. It lets you paste in up to 10 PICT resources and will display them. This could be useful in doing on-line help, for example.

### Programmer's Key 1.1B3 INIT

This is version 1.1B3 of Paul Mercer's Programmer's Key INIT. For those who use Apple Desktop Bus

keyboards, Programmer's Key lets you interrupt or reset your Mac without using the switch on the side; it works in conjunction with the "Triangle" key, or the power-on key for Mac II users. Pressing Command-Triangle generates an interrupt, while Command-Shift-Triangle resets your computer.

### ShowCInit 1.0b1

This file contains ShowCInit, a resource for displaying colour icons from within INIT and cdev files. This resource is an upwards-compatible replacement for Paul Mercer's "ShowINIT". It supports color icons, multiple (animated) icons, automatic icon-wrapping at the right edge of the screen, support for startup sounds and sysbeeps, and easy modification via a ResEdit template (provided). It is said to be compatible with all Macs except possibly for the 128k and 512k machines with the old 64k ROMs. ShowCInit was written by Joe Sternlicht and Andrew Diaz. They ask a shareware payment of \$1 (\$2 if you're feeling generous). Source code is available from the authors for a modest additional fee.

### Varityper FontWizard 1.0 DA

This is a desk accessory written by Ken Winograd and sponsored by Varityper. From the Read Me file included in the archive: Varityper FontWizard is a desk accessory that approaches the problem of font management from the perspective of the FOND resource.

### Varityper FontMaster 1.1 DA

The FontMaster desk accessory, version 1.1 written by Ken Winograd and sponsored by Varityper. FontMaster can show you statistics on the fonts you have installed (point sizes, styles, size in bytes, FONT ID's, FOND ID's, resource types (FONT or NFNT), and can also display sample text in each font.

### Leprechaun Demo

This is a multi-level action game.

Push the pot of gold to the rainbow while avoiding the nasties! This game supports Color QuickDraw (when available) or classic QuickDraw. Also uses extensive digitized sound effects. The commercial version will have over a hundred levels.

### Montana

A solitaire card game.

## 910 Update 10

### Remember 1.3

New features include color support and buttons to advance calendar month and year.

### McSink 6.5 DA

This is version 6.5 of the shareware McSink text editing DA. This version adds no new features, but fixes some of the problems with the last release (6.2a). Also changed is the price to upgrade to Vantage, the commercial version of McSink, which has a number of other goodies (spelling checker, reads MacWrite/WriteNow files, macros, external Gnome 1.0

Here's a programmable metronome. It does constant rate, of course, but can be told to vary its rate



over time - useful for practicing scales, etc. progressively faster.

#### **Doctor 2.35**

This application will allow you to make a text file, or let you copy text into it, and allow you to save it as either a stand-alone document, or a regular text file. The user is able to take a text file, and save it as an application. You're able to make help files, instructions, or anything, without needing to worry if the person who will be reading the info had macwrite/msword etc.

#### **Technical Notes**

TNs issued February 1989 - some earlier notes updated and numbers 222 to 232.

#### **911 Update 11**

##### **ApplicationMenu 3.4**

This version fixes a bug which could cause a crash if you try to activate ApplicationMenu when there are no menus in the menu bar. If you have version 3.3 of ApplicationMenu you can preserve all your current settings by dragging version 3.4 to your hard disk, and before rebooting, opening the Control Panel and selecting ApplicationMenu. Then reboot so that the new code can install itself.

##### **Carpet 2.0**

A carpet is a kind of two dimensional rectangular fractal. Carpet is a program which allows you to interactively create and manipulate carpets. With some experience, you will be able to create patterns of astonishing complexity and beauty. Simple color is supported. A tutorial help document and a number of samples are included.

##### **DistillPS 3.0b1**

The DistillPS program is an adapted version of the SendPS program that has been available for some time. There are several features for downloading PostScript language programs. The options under the "File" menu are for simple downloading of files, for distilling files, and for timing them.

##### **Ignisound V1.4**

An INIT/cdev combination to play a specified HyperCard/SND format sound at startup. Shareware. Requires System 6.0 or later.

##### **WindowList 1.21**

WindowList is an INIT that allows the user to pop up a menu of open windows by command-clicking in the title of the current window. This allows for easy access to windows that are totally obscured by windows in front of it.

##### **CheapColor 1.0.3**

CheapColor is an application that converts PICT2 and PixelPaint docs into PICT1 docs and prints them in color on an ImageWriter with a color ribbon. I'm told it also works on a HP PaintJet.

##### **ZTerm 0.75**

Here's an update to ZTerm, a shareware communications program that supports ZModem, YModem, and XModem file transfers, and includes VT100 terminal emulation.

##### **FWP Diddler**

FWP Diddler is a small INIT that was created to allow On Cue™ to work normally with FWP. In addition, many other utilities that use or alter standard menus will now also work with FWP. Fortunately, none of the functionality of FWP itself has been altered in any way. 🍏

## A solution for everyone . . .

We offer the full range of Apple II and Macintosh 512K, Plus, SE and II computers, accessories and software from individual items to sophisticated systems for the latest applications in desk top publishing or computer aided design at competitive prices.

Whatever your interests as a newcomer, enthusiast, professional, small business or large public company, we can provide new and used equipment, with excellent service, reliability and after-sales maintenance, training and support.

With such a wide range of Apple Macintosh equipment and applications, why not call us to discuss your requirements.

### **ROGER D'ARCY COMPUTERS**

Tel.: Oxford (0865) 728787

# Chameleon Software

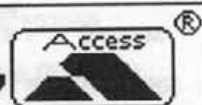

## **Branded SONY Disks**

**3.5" DS/DD (box of 10) £11**

*Buy 80 and get a free 80 capacity disk box*

#### Disk Boxes

80 Capacity 3.5" (lockable w hinged lid) £6

150 Capacity 3.5" Passo Box (grey) £14

#### Mouse Mats

12" x 9" x 5mm, this one is BIG! (red or blue) £4

*We can supply a wide range of Apple II and Macintosh hardware and software at hard to beat prices. We also sell books, paper, labels, 2nd user items, printers, inline buffers, etc, etc.*

Chameleon Software

**FREEPOST**

Pinchbeck

Spalding

Lincs PE11 3BR

Send for our latest list,  
no stamp required.

Prices exclude VAT and  
P & P.

**Tel: 0775 85481**

# User Groups

## London Region

### ESSEX GROUP

CONTACT - Pat Bermingham Tel : (01274) 811111  
VENUE - The Y.M.C.A., Victoria Road, Chelmsford  
MEETS - Third Friday of every month

### CROYDON APPLE USERS GROUP

CONTACT - Graham Attwood Tel : (0181) 811111  
VENUE - 515, Limpfield Road, Warlingham, Surrey  
MEETS - 7.30pm on the third Thursday of every month

### HERTS & BEDS GROUP

CONTACT - Norah Arnold Tel : (0494) 811111  
VENUE - The Old School, 1, Branch Road,  
Park Street Village, St Albans, Herts.  
MEETS - 8.00pm on the first Tuesday of each month

### KENT GROUP

CONTACT - Richard Daniels Tel : (0181) 811111  
VENUE -  
MEETS - Contact Richard

### LONDON APPLE II GROUP

CONTACT - Chris Williams Tel : (011) 811111  
VENUE -  
MEETS - Contact Chris

### LONDON MACINTOSH GROUP

CONTACT - Maureen de Saxe Tel : (011) 811111  
VENUE - Room 683, London University Institute of  
Education, Bedford Way, London, WC1  
MEETS - 6.00pm on the second Tuesday of every  
month.

### M25 BUSINESS MAC GROUP

CONTACT - Jim Panks Tel : (0181) 811111  
VENUE - Sir Mark Collett Pavilion, Heaverham Road,  
Kemsing, Sevenoaks, Kent  
MEETS - Phone Jim for details

### SOUTH EAST ESSEX MAC GROUP

CONTACT - Mick Foy Tel : (01702) 811111  
VENUE - D.P.S. Acorn House, Little Oaks, Basildon,  
Essex  
MEETS - First Monday of each month

## South

### POOLE MACINTOSH USER GROUP

CONTACT - David Huckle Tel : (01202) 811111  
VENUE - Deverill Computers (dealer)  
Itec House, 34-40 West Street, Poole, Dorset  
BH15 1LA  
MEETS - Four times a year

### SOUTHAMPTON

CONTACT - Geoff Parson Tel : (0703) 811111 (Home)  
Tel : (0703) 811111 (Work)  
VENUE - Contact Geoff for details

## Wales and West

### BRISTOL GROUP (B.A.U.D)

CONTACT - Colin Rogers Tel : (0117) 811111 (Home)  
Tel : (0117) 811111 (Work)  
VENUE - Decimal Business Machines  
Three Queens Lane, Redcliffe  
MEETS - 7th day of each month, or the Friday nearest  
to it if the 7th falls on a Saturday or Sunday

### HANTS & BERKS GROUP

CONTACT - Joe Cade Tel : (01256) 811111  
VENUE - Thames Valley Systems (Apple Dealer),  
128 High Street, Maidenhead, Berkshire,  
SL6 1PT Tel 0628-25361  
MEETS - 7.00pm on the second Monday of every month

### MACTAFF - SOUTH WALES MAC GROUP

CONTACT -  
VENUE - Apple Centre South Wales, Longcross Court  
47 Newport Road, Cardiff  
MEETS - Contact Apple Centre

## Midlands

### CAMBRIDGE APPLE USERS GROUP

CONTACT - || Ian Archibald Tel : (01223) 811111  
Mac Richard Boyd Tel : (01223) 811111  
VENUE - Impington Village College, New Rd, Impington,  
Histon.  
MEETS - Fortnightly during term time with both Mac  
and Apple II on deck each night.

### EAST MIDLANDS MAC USER GROUP

CONTACT - Nick Helm Tel : (01530) 811111  
VENUE - Wilford Cricket & Rugby Club, Nottingham  
MEETS - 8.00pm on the first and third Wednesday of  
every month.

### GATEWAY COMPUTER CLUB

CONTACT - Vern Tel : (0115) 811111  
Robin Boyd Tel : (0115) 811111  
VENUE - Bob Hope Recreation Centre, R.A.F Mildenhall  
MEETS - AMS conference room, Mildenhall base.  
Normally at weekends, check with Robin  
NOTE : Although the venue is on a service  
base it is not in a security restricted area so  
the club is open to interested parties.



## LEICESTER GROUP

CONTACT - Bob Bown Tel : (0533) 477515  
VENUE - Shakespeare Pub, Braunstone Lane,  
Leicester  
MEETS - 7.30pm to 10.0pm on the first Wednesday of  
every month

## LIVERPOOL GROUP

CONTACT - Irene Flaxman Tel : (051) 424-0907  
VENUE - Check with Irene  
MEETS - First Tuesday of every month.

## MIDAPPLE

CONTACT - Tom Wright Tel : (0527) 575048  
VENUE - I.T.E.C., Tildasley Street, West Bromwich,  
West Midlands  
MEETS - 7.00pm on the second Friday of every month

## THE MIDLAND MAC GROUP

CONTACT - Ivan Knezovich Tel : (0522) 401414  
VENUE - Spring Grove House, West Midland Safari  
Park, Bewdley, Worcestershire.  
MEETS - 8.00pm on the first Tuesday of every month

## WEST MIDLANDS AMATEUR COMPUTER CLUB

CONTACT - John Tracey Tel : (0522) 780137  
VENUE - Hill Crest School, Simms Lane, Netherton,  
Near Dudley.  
MEETS - 7.00pm on the second and fourth Thursdays  
of each month.

NOTE - - This is not an Apple user club, it is a  
general interest club which welcomes users of  
all machines. There are currently two Apple  
user members.

## North

### BURNLEY APPLE USER GROUP

CONTACT - Rod Turnough Tel : (0762) 741111  
VENUE - Michelin Sports Centre  
MEETS - 2nd Wednesday of each month

### CREW COMPUTER USER CLUB

CONTACT - Paul Edmonds  
VENUE - Christ Church Hall, Crewe  
MEETS - Fortnightly, Fridays, 7.30pm to 10.00pm  
NOTE: this is a general interest group with  
Apple users among its members

### HARROGATE AREA

CONTACT - Peter Sutton Tel : (0438) 817511  
No active organised group in this area but there  
are a number of keen Apple users in contact with  
each other.

### THE NORTH EAST APPLE COMPUTER CLUB

CONTACT - Philip Dixon Tel : (0431) 405111  
VENUE - Apple Centre North East, Ponteland Road,  
Ponteland, Newcastle-on-Tyne  
MEETS - First Wednesday of every month

### THE NORTH WEST APPLE COMPUTER CLUB

CONTACT -  
VENUE - Horse & Jockey Pub., Winwick Road,  
Warrington  
MEETS - First Monday of every month

## THE NORTH WEST APPLE USERS GROUP

CONTACT - Max Parrot  
Tel : (061) 426-3111, (061) 426-3111  
Tel : (061) 426-3111  
VENUE -  
MEETS - Ring Max

## Scotland

### EDINBURGH GROUP

CONTACT - Ricky Pollock Tel : (031) 557-0768  
VENUE -  
MEETS - Meetings monthly, check with Ricky

## Postal

### APPLE II PROGRAMMERS CLUB

CONTACT - Philip Dixon TEL : (0434) 600111  
VENUE - None established yet  
MEETS - No meetings yet, has operated through  
postal newsletter published quarterly

NOTE : Philip started the club some time ago based  
on a membership fee of £1.00 to cover the cost of  
newsletters. Original intention was to concentrate  
on BASIC and Assembler programming.

## New Groups

### DORCHESTER

CONTACT - Ron Hoare Tel : (01274) 301111  
VENUE -  
MEETS - Meeting on March 1st -contact Ron Hoare

### ORPINGTON COMPUTER CLUB

CONTACT - Terry Wheeler Tel : (01892) 311111  
VENUE - G.E.A. Hall, Woodhurst Avenue, Petworth  
MEETS - Contact Terry

### DONCASTER SOUTH YORKSHIRE

CONTACT - Colin Withington Tel : (01924) 311111  
VENUE -  
MEETS - Contact Colin

### LEEDS

CONTACT - Bob Miller Tel : (0532) 575111  
- T Veluppillal Tel : (0532) 754111  
VENUE -  
MEETS - Contact Bob

**If you want to start a group, find out about a  
group that might be near you, please write or  
contact John Lee the Local Group Organiser at  
the PO Box in Liverpool, or phone John Lee on  
0373 84 861.**

**If you are a local group organiser and have not  
been in touch with John Lee, please contact  
John with details of your group, or any  
changes there may be to the above details.**

Members' Small Adverts are FREE. Please help us to help you. Send your advertisements to us on a disk, in Mac or Apple II text format. We will return the disk, of course. This saves us time, and avoids errors.

# Members' Small Ads

Members' Small Adverts are FREE. We reserve the right to edit and or omit them. They are placed in this Magazine in good faith. Apple2000 holds no responsibility over items advertised, and buyers purchase at their own risk.

**WARNING: The sale of copied or pirated software is illegal. Please ensure that items offered for sale are new or are re-registered.**

## FOR SALE

Apple II+ compatible. 64K.  
 Numeric keypad, U/L case, 2 Apple d/drives, green monitor, lots software.  
 Bausch & Lomb graphics tablet, Hitachi 4-col A4/A3 plotter, Polaroid Palette graphics imaging system c/w cameras, Robo-system, drafting system, controller & software.  
 Epson RX-80 printer.  
 Delivery can be arranged ..... The lot **£950** o.v.n.o.  
 'Phone Jack McMichael ..... 0133 013344

## FREE DEMONSTRATION DISK

'@WORK': Computer-Aided-Software-Engineering program (CASE) for the Apple //e, //c and IIGs. For a free demonstration disk please send a disk and SAE to:  
**P McMullin, 5 Lambwood, Huddley Park, Huddersfield, W. Yorks., WF2 4BB**

## FOR SALE

Apple IIGS software:

Wordperfect 2.0 ..... £45.00  
 Shanghai, Marble Madness ..... (each) £12.50  
 Apple II+ onwards (64K unless marked):  
 TimeOut Quickspell (Appleworks add-on) ..... £20.00  
 Bard's Tale II, Under Fire ..... (each) £17.50  
 Sargon III, Computer Ambush (48K) ..... (each) £10.00  
 Wizardry IV - Return of Werdna ..... £17.50  
 Infocom Adventures:  
 Leather Goddesses of Phobos ..... (each) £12.50  
 Stationfall or The Lurking Horror (min 3) ... (each) £10.00  
 Spellbreaker or Witness ..... (all ten) £80.00  
 Sorcerer Bureaucracy (128K) Border Zone (128K)  
 Trinity (128K) Mind Forever Voyaging (128K)  
 I'll pay the postage on any orders over £25.00  
 'Phone Peter Kemp (evenings/weekends) 0133 45512

## FOR SALE

AppleWriter II v.2.0 (ProDOS). Includes master disk, tutor disk, and two manuals - all originals ..... £50 o.n.o.  
**WANTED** - AppleWorks IIGS, preferably with the manuals  
 'Phone Jonathan Shippam (after 4pm) 0133 013312

## FOR SALE

1Mb NEC 41256 -15 high quality RAM. Suitable for Ramworks I, II, III or other applications ..... £140  
 or 512K ..... £75  
 Z80 Softcard ..... £14  
 Epson Printer Card ..... £14  
**Martin Tse, 5 Woodbury Street, Burslem, Stoke 10 0134 011**

## FOR SALE

PageMaker v.2 ..... £149  
 MacWrite v.5 (with spelling checker) ..... £59  
 Mac Plus numeric keypad ..... £39  
 MacSpellRight (use with old version of MacWrite) .... £15  
 Omnis 3 Plus database ..... £99  
 Omnis Express database generator ..... £20  
 Pison Organiser II XP 32K (as new, not 12 mths old) £79  
 (accessories also available please call for details/prices)  
 'Phone Richard Thatcher ..... 0727 30212

## FOR SALE

Numerous items for sale, of which there follows a sample.  
 Apple manuals, including:-  
 ProDOS User's Manual  
 Apple 6502 Assembler/Editor  
 The Applesoft Tutorial  
 Books, including:-  
 Apple II User's Guide by Lon Pool  
 Beneath Apple DOS by Don Wirth & Peter Lechner  
 Software Manuals, including:-  
 Visicorp Personal Software (various)  
 Beagle Bros (various)  
 Microsoft Multiplan for Apple II or III  
 PFS Graph, File, Report User's Manual  
 Original Software with Manuals, including:-  
 dBase II, User's Manual Vol 1 & Vol 2  
 ScreenWriter II Professional WP System  
 Edit-Soft, Applesoft Basic Line Editor  
 'Phone Peter Dyson (any time) ..... 0133 013312

## FOR SALE

Apple IIGS with monochrome monitor, keyboard, mouse, 3.5" drive, 2 x 5.25" drives (one Apple manfr.); 1.25 Meg. memory; 1 Meg Flipper card; Apple Super Serial Card; Olivetti PR430 15" carriage Daisywheel Printer; host of disks, manuals etc.  
 First cash payment of **£800.00** secures, buyer collects.  
**Mike Scott, c/o 3 Silver Walk, St. Martin's Square, Leicester, LE1 6BW**

## FOR SALE OR TRADE

Apple //e 128K. Apple /// green monitor  
 Apple 80-col card. Z80 (CP/M) card.  
 2 Apple II drives with controller card  
 Apple dot matrix printer. Prograppler parallel card.  
 Pascal, Visicalc, AppleWriter, Task, Bag of Tricks, etc.  
 I will trade. **REQUIRED** - colour monitor, etc. for IIGS.  
**Offers to Neil Robinson (any time) ..... 0133 455 1212**

# Advertisers' Index

ACME Computer Service Co.	75	The MacSerious Company	Back cover
Bidmuthin Technologies Ltd	9,69	MacSolutions UK Ltd	53
Celtip Computers	65	MacSoft	59
Chameleon Software	77	MacWise	52
Cirtech (UK) Ltd	Inside front cover	MGA SoftCat	27,31,33,37
Computability	39	Open Apple/A2 Central	17
Comtec	39	Roger D'Arcy Computers	77
Day Computing	52	Spacific Software	35
Holdens Computer Services	Inside back cover	Strategic Plus Software	17
Kingsway Computer Services	39	Supreme Mac Software Ltd	23
MacLine	40,41	T-systems Ltd	31



# Do You Enjoy Flying?

Applied Engineering have done it again! The TransWarp GS accelerator turns the GS into arguably the machine it should have been in the first place. Give your GS the boost it needs and watch it fly!

As one of Europe's major Suppliers of Applied Engineering Products we're very excited about this new development. Like all AE Products the TransWarp GS is a meticulous design and we heartily recommend this Card to all Apple II GS users.

**TransWarp GS (6.5 MHz) £349.00**

One of the most underestimated AE cards is the Serial Pro. This board emulates perfectly the Apple Super Serial Card, and on top of that it's a Clock Card as well! Unlike the Super Serial Card the Serial Pro has 'Soft' DIP Switches, and all the settings can be made without taking the lid off your machine. Software is included to patch ProDOS so that it recognises the on-board Clock. A true value for money Multi Function Card.

**Serial Pro II+, IIe, II GS £89.00**

You can't keep a good product down, and that's certainly the case with the Applied Engineering PC Transporter Card. Reports coming back from users indicate that it certainly is very PC Compatible. The Transporter runs three times faster than an IBM XT and you can even exchange data from ProDOS to MS-DOS and back again. When you're working in native ProDOS the PC Transporter is by no means redundant; it acts as a RAM Card conforming to Apple's Memory Expansion Card Protocol. It seems there's never been a better time to own an Apple II.

**PC Transporter II+, IIe, II GS £399.00**  
(Installation Kits £29.00)

Please add VAT @ 15% to all our Prices

## Applied Engineering Products

### APPLE II+, IIe, II GS

TransWarp GS .....	£349.00
GS RAM 512K (Expandable to 1MB) .....	£229.00
GS RAM Plus 1MB (Expandable to 6MB) ....	£349.00
1MB Upgrade .....	£165.00
PC Transporter with 768K (640K PC) .....	£399.00
Installation kit for Apple II GS .....	£29.00
Installation kit for Apple II e/II+ .....	£29.00
TransDrive 360K Single Drive .....	£139.00
TransDrive 360K Dual Drive .....	£199.00
360K Upgrade Mechanism .....	£79.00
IBM Style Keyboard incl. Cable .....	£79.00
Digital RGB Adaptor cable IIe .....	£15.00
ColorSwitch Analogue RGB Adaptor .....	£25.00
8087-2 Maths Co-processor Chip .....	£149.00
128K Zip Chips for Transporter (Set of 4) .....	£75.00
Buffer Pro 32K .....	£69.00
Parallel Pro .....	£69.00
Serial Pro .....	£89.00
RamFactor 512K .....	£239.00
RamKeeper II GS .....	£119.00
Sonic Blaster II GS .....	£79.00
TimeMaster HO .....	£69.00
Phasor .....	£99.00
A/D + D/A Card .....	£119.00
16 Channel, 12 bit A/D .....	£159.00
I/O 32 Card .....	£49.00
High Output Power Supply (Not GS) .....	£69.00

### APPLE IIe

RamWorks III 256K .....	£139.00
RamWorks III 512K .....	£219.00
RamWorks III 1MB .....	£399.00
RamWorks III 3MB .....	£999.00
TransWarp Accelerator Card .....	£129.00

### APPLE IIC

Z-RAM Ultra III 256K .....	£239.00
Z-RAM Ultra III 512K .....	£319.00
Z-RAM Ultra III 1MB .....	£459.00
Z-RAM Ultra II 256K .....	£169.00
Z-RAM Ultra II 512K .....	£249.00
Z-RAM Ultra II 1MB .....	£429.00
Z-RAM Ultra I 256K .....	£149.00
Z-RAM Ultra I 512K .....	£229.00

## Holdens Computer Services

The Mansions, Chapel Lane,  
Longton, Preston, Lancashire PR4 5EB

FAX (0772) 615919 TEL (0772) 615512



## Think 'n Time

**New**

Think 'n Time is the Macintosh visual organization tool that significantly improves productivity. It's great for developing and organizing ideas, projects, tasks, meetings, schedules, estimates and reports.

### Organize Activities & Projects

Visually organize information using an extended desktop. Think 'n Time, T'nT for short, builds an organized tree of sheets and piles of electronic paper.

You create, open, close, collapse, expand and rearrange sheets and piles, all with point and click ease.

Drag sheets or piles to a new position in the tree to reorganize a subject. T'nT links text information to dates and times and numeric values in a completely integrated manner. It's handy for everything from project management to remembering important appointments and birthdays.

### Organize Your Future!

Integrated date and time management functions provide an easy way to plan your personal and business activities. T'nT allows you to more effectively plan, schedule, organize, arrange, delegate, direct, control, monitor and analyze your work.

No matter how complicated your life, a "What's Next?" view provides a time-line organization, keeping you on track. A powerful search and browse capability gives you instant recall. Here's real help to handle multiple tasks and projects.

A desk accessory, T'nT is always available for taking down information and accessing ideas, dates, notes and data, eliminating slips of paper.

Think 'n Time ..... £84.95



## MacFlow 2.0

*Fast, Clear Charts.*

**New Version**

Simply drag chart objects into place and connect them with flow lines. Draw flowcharts up to ten times faster than with drawing programs or pen and pencil. Enter text into symbols, lines and labels with ease.

Changes are just as easy. Resize symbols and move them around as you like; lines stretch and stay attached. Changes are a snap with automatic grid alignment. Resize symbols and add or delete elements with cut, copy and paste ease. Graphically organize even complex programs, projects and structures fast!

### Symbols, Your Way.

Use ANSI standard flowcharting symbols or custom design your own symbols with MacDraw™ or any "draw" type program. A hierarchical organization links a symbol on a top level chart to an entire lower level chart.

MacFlow 2.0 ..... £175.00

## MacSCHEDULE

**New**

Visually plan how a project will get done. MacSchedule lets you create clear, graphic schedules fast! Schedules that took hours, now take only minutes. Revisions that almost meant starting from scratch now only take a few seconds.

MacSchedule allows the creation and modification of a schedule directly without elaborate flow diagrams or detailed tables of dependencies.

Status tracking is a snap. Work progression, early and late starts and schedule slips are easily handled. Schedules can be yearly, quarterly, monthly, half-monthly, weekly, daily or free-form. Print out clear, attractive presentations on an ImageWriter or LaserWriter.

MacSchedule addresses the real needs of people making real schedules. It's not complicated PERT chart software that almost requires a degree in project management.

MacSchedule is for the practical, top-down thinker who wants to clearly see the entire picture and then make sure that the job gets done.

MacSCHEDULE ..... £175.00

## V.I.P 2.5

**New Version**

Programming of the future, here today! Visualize your logic and program at a speed you never thought possible! Use V.I.P's graphic editor to develop an icon-based, on-screen flow chart which runs.

You program in a top-down, structured manner using objects, automatic logic forms, nested levels of routines and over 180 pre-compiled procedures

### Power for professionals.

Develop and market your software using the run-time package with no extra license fees. V.I.P's also great for prototyping complex routines and models, even for other computers.

Follow-on products make V.I.P the language of choice. These include a series of translators — program visually and then turn a V.I.P program into source code for your favorite C or Pascal. Also available are procedure sets for speech, grid, ISAM, database, matrix, etc...

### HyperCard External Procedures I

Starting with the new 2.5 version, V.I.P will let you write external procedures and functions for HyperCard™ (XCMD's & XFCN's) and V.I.P itself. This will require the new Translators to C.

V.I.P 2.5 ..... £99.95

Grid Manager ..... £54.95

Telecom Manager ..... £99.95

Advanced Manager I ..... £89.95

DataBase Manager ..... £245.00

Matrix Manager ..... £89.95

Translators (Lightspeed C & Pascal, MPW C & Pascal, Turbo Pascal) ..... £89.95

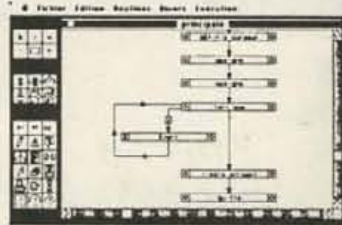

(All prices exclude VAT)

For more information visit the AppleCentre today!  
Distributed in Britain and Ireland by

# MacSerious

## The MacSerious Company

Mainstay Europe  
Rue des Atrebatas, 71  
B-1040 Brussels  
Belgium  
Tel (322) 733.97.91  
Fax (322) 734.89.12  
Telex 62 239 Micro b