



Apple® II

# Apple IIgs™ ProDOS® 16 Reference

Includes System Loader

```
ProDOS 16 System Call Exerciser v1.0
Copyright Apple Computer, Inc. 1987 All Rights Reserved

#01-Create          #08-Clr backup bit  #17-Get Mark      #23-Write Block
#02-Destroy        #09-Open           #18-Get EOF      #24-Format
#04-Change Path   #11-Newline        #19-Get EOF      #27-Get Name
#05-Get File Info #12-Read           #20-Get Level    #28-Get Boot Vol
#06-Get File Info #13-Write          #20-Get Level    #33-Quit
#08-Volume        #14-Close         #20-Get Dev Num  #29-Get Version
#09-Set Prefix    #15-Flush         #21-Get Last Dev #31-Alloc Int
#0A-Get Prefix    #16-Set Mark      #22-Read Block   #32-Dealloc Int

L - List directory      M - Modify memory
X - Exit to monitor    Q - Quit

Select command: #01
```



# Apple® II Apple IIgs ProDOS® 16 Reference

Includes System Loader

```
ProDOS 16 System Call Exerciser v1.0
Copyright Apple Computer, Inc. 1987 All Rights Reserved

#01-Create          #08-Clr backup bit  #17-Get Mark      #23-Write Block
#02-Destroy        #10-Open          #18-Set EOF       #24-Format
#04-Change Path    #11-Newline        #19-Get EOF       #27-Get Name
#05-Get File Info  #12-Read           #1A-Set Level     #28-Get Boot Vol
#06-Get File Info  #13-Write          #1B-Get Level     #29-Quit
#08-Volume         #14-Close         #20-Get Dev Num   #2A-Get Version
#09-Set Prefix     #15-Flush         #21-Get Last Dev  #31-Alloc Int
#0A-Get Prefix     #16-Set Mark      #22-Read Block    #32-Dealloc Int

L - List directory      M - Modify memory
X - Exit to monitor    Q - Quit

Select command: #01
```



**Addison-Wesley Publishing Company, Inc.**

Reading, Massachusetts Menlo Park, California Don Mills, Ontario  
Wokingham, England Amsterdam Bonn Sydney Singapore Tokyo  
Madrid Bogotá Santiago San Juan



Th  
Th  
Ap  
Now  
have  
about  
App  
infor  
from  
a co  
pow  
Whe  
the  
info  
prog  
the  
The  
Con  
tho  
App  
Title  
title  
T  
A  
A  
A  
A  
A  
E  
A  
I

🍏 APPLE COMPUTER, INC.

Copyright © 1987 by Apple Computer, Inc.

All rights reserved. No part of this publication may be reproduced, stored in a retrieval system, or transmitted, in any form or by any means, mechanical, electronic, photocopying, recording, or otherwise, without prior written permission of Apple Computer, Inc. Printed in the United States of America.

Apple, the Apple logo, AppleTalk, Disk II, LaserWriter, Lisa, ProDOS, and UniDisk are registered trademarks of Apple Computer, Inc.

Apple IIGS, Apple DeskTop Bus, AppleWorks, and Macintosh are trademarks of Apple Computer, Inc.

ITC Avant Garde Gothic, ITC Garamond, and ITC Zapf Dingbats are registered trademarks of International Typeface Corporation.

Microsoft is a registered trademark of Microsoft Corporation.

POSTSCRIPT is a trademark of Adobe Systems Incorporated.

Simultaneously published in the United States and Canada.

ISBN 0-201-17754-4  
ABCDEFGHIJ-DO-89877  
First printing, May 1987

#### LICENSING REQUIREMENTS

Apple has a licensing program that allows software developers to incorporate Apple-developed object code files into their products. A license is required for both in-house and external distribution. Before distributing any products that incorporate Apple software, please contact Software Licensing for licensing information.



# Contents

**Figures and tables xi**

**Radio and television interference x**

**Preface xv**

Road map to the Apple IIGS technical manuals xvi

How to use this manual xviii

Other materials you'll need xviii

    Hardware and software xviii

    Publications xix

Notations and conventions xx

    Terminology xx

    Typographic conventions xxi

    Watch for these xxi

## **Part I How ProDOS 16 Works 1**

### **Chapter 1 About ProDOS 16 3**

Background 4

What is ProDOS 16? 5

    Programming levels in the Apple IIGS 5

    Disks, volumes, and files 7

    Memory use 8

    External devices 9

ProDOS 16 and ProDOS 8 9

    Upward compatibility 10

    Downward compatibility 11

    Eliminated ProDOS 8 system calls 11

    New ProDOS 16 system calls 12

    Other features 12

Summary of ProDOS 16 features 13



## **Chapter 2 ProDOS 16 Files 17**

- Using files 18
  - Filenames 18
  - Pathnames 19
  - Creating files 21
  - Opening files 21
  - The EOF and Mark 22
  - Reading and writing files 24
  - Closing and flushing files 24
  - File levels 25
- File format and organization 26
  - Directory files and standard files 26
  - File organization 27
  - Sparse files 30

## **Chapter 3 ProDOS 16 and Apple IIgs Memory 31**

- Apple IIgs memory configurations 32
  - Special memory and shadowing 34
  - ProDOS 16 and System Loader memory map 34
  - Entry points and fixed locations 35
- Memory management 36
  - The Memory Manager 37
  - Pointers and handles 38
  - How an application obtains memory 39

## **Chapter 4 ProDOS 16 and External Devices 41**

- Block devices 42
- Character devices 43
- Accessing devices 43
  - Named devices 44
  - Last device accessed 44
  - Block read and block write 44
  - Formatting a disk 45
- Number of online devices 45
  - Device search at startup 45
  - Volume control blocks 47
- Interrupt handling 47
  - Unclaimed interrupts 49

## Chapter 5 ProDOS 16 and the Operating Environment 51

- Apple IIGS system disks 52
  - Complete system disk 52
    - The SYSTEM.SETUP/ subdirectory 53
  - Application system disks 54
- System startup 55
  - Boot initialization 56
  - Startup program selection 58
- Starting and quitting applications 59
  - PQUIT 60
    - Standard ProDOS 8 QUIT call 60
    - Enhanced ProDOS 8 QUIT call 60
    - ProDOS 16 QUIT call 61
  - QUIT procedure 62
  - Machine configuration at application launch 64
- Pathname prefixes 65
  - Initial ProDOS 16 prefix values 67
  - ProDOS 8 prefix and pathname convention 68
- Tools, firmware, and system software 70
  - The Memory Manager 70
  - The System Loader 70
  - The Scheduler 71
  - The User ID Manager 71
  - The System Failure Manager 72

## Chapter 6 Programming With ProDOS 16 73

- Application requirements 74
- Stack and direct page 75
  - Automatic allocation of stack and direct page 75
    - Definition during program development 76
    - Allocation at run time 77
    - ProDOS 16 default stack and direct page 78
  - Manual allocation of stack and direct page 78
- Managing system resources 79
  - Global variables 79
    - Prefixes 80
  - Native mode and emulation mode 81
  - Setting initial machine configuration 81
  - Allocating memory 82
  - Loading another program 82
  - Using interrupts 83
  - Accessing devices 84
- File creation/modification date and time 84



## **Chapter 6 Programming With ProDOS 16 (continued)**

- Revising a ProDOS 8 application for ProDOS 16 86
  - Memory management 86
  - Hardware configuration 87
  - Converting system calls 88
  - Modifying interrupt handlers 88
  - Converting stack and zero page 88
  - Compilation/assembly 89
- Apple IIGS Programmer's Workshop 89
- Human Interface Guidelines 90

## **Chapter 7 Adding Routines to ProDOS 16 93**

- Interrupt handlers 94
  - Interrupt handler conventions 94
  - Installing interrupt handlers 95
  - Making operating system calls during interrupts 96

## **Part II ProDOS 16 System Call Reference 97**

### **Chapter 8 Making ProDOS 16 Calls 99**

- The call block 100
- The parameter block 101
  - Types of parameters 102
  - Parameter block format 102
  - Setting up a parameter block in memory 103
- Register values 104
- Comparison with the ProDOS 8 call method 105
- The ProDOS 16 Exerciser 106
- Format for system call descriptions 106

### **Chapter 9 File Housekeeping Calls 109**

- CREATE (\$01) 111
- DESTROY (\$02) 115
- CHANGE\_PATH (\$04) 117
- SET\_FILE\_INFO (\$05) 119
- GET\_FILE\_INFO (\$06) 123
- VOLUME (\$08) 128
- SET\_PREFIX (\$09) 131
- GET\_PREFIX (\$0A) 133
- CLEAR\_BACKUP\_BIT (\$0B) 134

**Chapter 10 File Access Calls 135**

OPEN (\$10) 137  
NEWLINE (\$11) 139  
READ (\$12) 141  
WRITE (\$13) 143  
CLOSE (\$14) 145  
FLUSH (\$15) 146  
SET\_MARK (\$16) 147  
GET\_MARK (\$17) 148  
SET\_EOF (\$18) 149  
GET\_EOF (\$19) 150  
SET\_LEVEL (\$1A) 151  
GET\_LEVEL (\$1B) 152

**Chapter 11 Device Calls 153**

GET\_DEV\_NUM (\$20) 155  
GET\_LAST\_DEV (\$21) 156  
READ\_BLOCK (\$22) 157  
WRITE\_BLOCK (\$23) 159  
FORMAT (\$24) 160

**Chapter 12 Environment Calls 163**

GET\_NAME (\$27) 165  
GET\_BOOT\_VOL (\$28) 166  
QUIT (\$29) 167  
GET\_VERSION (\$2A) 171

**Chapter 13 Interrupt Control Calls 173**

ALLOC\_INTERRUPT (\$31) 175  
DEALLOC\_INTERRUPT (\$32) 177

**Part III The System Loader 179**

**Chapter 14 Introduction to the System Loader 181**

What is the System Loader? 182  
Loader terminology 183  
Interface with the Memory Manager 184  
Loading a relocatable segment 187  
    Load-file structure 187  
    Relocation 188



The  
The  
App  
Now A  
have c  
about  
Apple  
inform  
from c  
a com  
power  
Wheth  
the ne  
inform  
progr  
the co  
These  
Comp  
those  
Apple  
Titles  
titles f  
Tec  
App  
App  
App  
App  
App  
Pro  
App  
Imu

<b>Chapter 15</b>	<b>System Loader Data Tables 191</b>
	Memory Segment Table 192
	Jump Table 193
	Creation of a Jump Table entry 195
	Modification at load time 196
	Use during execution 196
	Jump Table diagram 197
	Pathname Table 199
	Mark List 201
<b>Chapter 16</b>	<b>Programming With the System Loader 203</b>
	Static programs 204
	Programming with dynamic segments 204
	Programming with run-time libraries 205
	User control of segment loading 206
	Designing a controlling program 207
	Shutting down and restarting applications 209
	Summary: loader calls categorized 210
<b>Chapter 17</b>	<b>System Loader Calls 211</b>
	Introduction 212
	How calls are made 213
	Parameter types 213
	Format for System Loader call descriptions 214
	Loader Initialization (\$01) 215
	Loader Startup (\$02) 216
	Loader Shutdown (\$03) 217
	Loader Version (\$04) 218
	Loader Reset (\$05) 220
	Loader Status (\$06) 221
	Initial Load (\$09) 222
	Restart (\$0A) 225
	Load Segment by Number (\$0B) 228
	Unload Segment by Number (\$0C) 232
	Load Segment by Name (\$0D) 234
	Unload Segment (\$0E) 236
	Get Load Segment Info (\$0F) 238
	Get User ID (\$10) 240
	Get Pathname (\$11) 242
	User Shutdown (\$12) 244
	Jump Table Load 247
	Cleanup 249



**Appendix A ProDOS 16 File Organization 253**

- Organization of information on a volume 254
- Format and organization of directory files 255
  - Pointer fields 256
  - Volume directory headers 256
  - Subdirectory headers 259
  - File entries 261
  - Reading a directory file 265
- Format and organization of standard files 267
  - Growing a tree file 267
  - Seedling files 270
  - Sapling files 270
  - Tree files 271
  - Using standard files 272
  - Sparse files 273
  - Locating a byte in a file 274
- Header and entry fields 275
  - The storage type attribute 275
  - The creation and last-modification fields 276
  - The access attribute 277
  - The file type attribute 278
  - The auxiliary type attribute 279

**Appendix B Apple II Operating Systems 281**

- History 281
  - DOS 281
  - SOS 282
  - ProDOS 8 282
  - ProDOS 16 283
  - Pascal 283
- File compatibility 283
  - Reading DOS 3.3 and Apple II Pascal disks 284
- Operating system similarity 285
  - Input/Output 285
  - Filing calls 286
  - Memory management 287
  - Interrupts 288



## **Appendix C The ProDOS 16 Exerciser 289**

- Starting the Exerciser 289
- Making system calls 290
- Other commands 291
  - List Directory (L) 291
  - Modify Memory (M) 291
  - Exit to Monitor (X) 293
  - Quit (Q) 294

## **Appendix D System Loader Technical Data 295**

- Object module format 295
  - File types 295
  - Segment kinds 296
  - Record codes 297
  - Load-file numbers 298
  - Load-segment numbers 298
  - Segment headers 299
    - Restrictions on segment header values 299
    - Page-aligned and bank-aligned segments 299
- Entry point and global variables 300
- User ID format 300

## **Appendix E Error Codes 302**

- ProDOS 16 errors 302
  - Nonfatal errors 302
  - Fatal errors 307
  - Bootstrap errors 309
- System Loader errors 310
  - Nonfatal errors 310
  - Fatal errors 311

**Glossary 313**

**Index 327**

---

---

## Figures and tables

### Preface xiv

Figure P-1 Roadmap to the technical manuals xvii

Table P-1 The Apple IIGS technical manuals xvi

### Chapter 1 About ProDOS 16 3

Figure 1-1 Programming levels in the Apple IIGS 6

Figure 1-2 Example of a hierarchical file structure 8

### Chapter 2 ProDOS 16 Files 17

Figure 2-1 Example of a ProDOS 16 file structure 20

Figure 2-2 Automatic movement of EOF and Mark 23

Figure 2-3 Directory file format 27

Figure 2-4 Block organization of a directory file 28

Figure 2-5 Block organization of a standard file 29

### Chapter 3 ProDOS 16 and Apple IIGS Memory 31

Figure 3-1 Apple IIGS memory map 32

Figure 3-2 ProDOS 16 and System Loader memory map 35

Figure 3-3 Pointers and handles 39

Figure 3-4 Memory allocatable through the Memory  
Manager 40

Table 3-1 Apple IIGS memory units 33

Table 3-2 ProDOS 16 fixed locations 36

Table 3-3 Memory block attributes 37

### Chapter 4 ProDOS 16 and External Devices 41

Figure 4-1 Interrupt handling through ProDOS 16 48

Table 4-1 Smartport number, slot number, and device  
number assignments 46

## **Chapter 5 ProDOS 16 and the Operating Environment 51**

Figure 5-1	Boot initialization sequence	57
Figure 5-2	Startup program selection	59
Figure 5-3	Run-time program selection (QUIT call)	63
Table 5-1	Contents of a complete Apple IIGS system disk	53
Table 5-2	Required contents of an Apple IIGS application system disk	55
Table 5-3	Examples of prefix use	66
Table 5-4	Initial ProDOS 16 prefix values	67
Table 5-5	Initial ProDOS 8 prefix and pathname values	69

## **Chapter 6 Programming With ProDOS 16 73**

Figure 6-1	Automatic direct-page/stack allocation	76
Table 6-1	Apple IIGS equivalents to ProDOS 8 global page information	80

## **Chapter 14 Introduction to the System Loader 181**

Figure 14-1	Loading a relocatable segment	188
Table 14-1	Load-segment/memory-block relationships (at load time)	186

## **Chapter 15 System Loader Data Tables 191**

Figure 15-1	Memory Segment Table entry	192
Figure 15-2	Jump Table Directory entry	194
Figure 15-3	Jump Table entry (unloaded state)	195
Figure 15-4	Jump Table entry (loaded state)	197
Figure 15-5A	How the Jump Table works	198
Figure 15-5B	How the Jump Table works	199
Figure 15-6	Pathname Table entry	200
Figure 15-7	Mark List format	202

## **Chapter 16 Programming With the System Loader 203**

Table 16-1	System Loader functions categorized by caller	210
------------	---	-----



## **Appendix A ProDOS 16 File Organization 253**

Figure A-1	Block organization of a volume	254
Figure A-2	Directory file format and organization	255
Figure A-3	The volume directory header	257
Figure A-4	The subdirectory header	259
Figure A-5	The file entry	262
Figure A-6	Format and organization of a seedling file	270
Figure A-7	Format and organization of a sapling file	271
Figure A-8	Format and organization of a tree file	272
Figure A-9	An example of sparse file organization	274
Figure A-10	File Mark format	275
Figure A-11	Date and time format	276
Figure A-12	Access byte format	277
Table A-1	Storage type values	276
Table A-2	ProDOS file types	278

## **Appendix B Apple II Operating Systems 281**

Table B-1	Tracks and sectors to blocks (140K disks)	284
-----------	---	-----

## **Appendix C The ProDOS 16 Exerciser 289**

Table C-1	ASCII character set	292
-----------	---------------------	-----

## **Appendix D System Loader Technical Data 295**

Figure D-1	Segment kind format	296
Figure D-2	User ID format	301



# Preface



The *Apple IIGS ProDOS 16 Reference* is a manual for software developers, advanced programmers, and others who wish to understand the technical aspects of the Apple IIGS™ operating system. In particular, this manual will be useful to you if you want to write

- a stand-alone program that automatically runs when the computer is started up
- a routine that catalogs disks, manipulates sparse files, or otherwise interacts with the Apple IIGS file system at a basic level
- an interrupt handler
- a program that loads and runs other programs
- any program using segmented, dynamic code

The functions and calls in this manual are in assembly language format. If you are programming in assembly language, you may use the same format to access operating system features. If you are programming in a higher-level language (or if your assembler includes a ProDOS® 16 macro library), you will use library interface routines specific to your language. Those library routines are not described here; consult your language manual.

---

---

## Road map to the Apple IIGS technical manuals

The Apple IIGS personal computer has many advanced features, making it more complex than earlier models of the Apple® II. To describe it fully, Apple has produced a suite of technical manuals. Depending on the way you intend to use the Apple IIGS, you may need to refer to a select few of the manuals, or you may need to refer to most of them.

The technical manuals are listed in Table P-1. Figure P-1 is a diagram showing the relationships among the different manuals.

**Table P-1**  
The Apple IIGS technical manuals

Title	Subject
<i>Technical Introduction to the Apple IIGS</i>	What the Apple IIGS is
<i>Apple IIGS Hardware Reference</i>	Machine internals—hardware
<i>Apple IIGS Firmware Reference</i>	Machine internals—firmware
<i>Programmer's Introduction to the Apple IIGS</i>	Concepts and a sample program
<i>Apple IIGS Toolbox Reference: Volumes 1 and 2</i>	How to use the Apple IIGS tools
<i>Apple IIGS Programmer's Workshop Reference</i>	The development environment
<i>Apple IIGS Programmer's Workshop Assembler Reference</i>	using the APW assembler
<i>Apple IIGS Programmer's Workshop C Reference</i>	Using C on the Apple IIGS
<i>ProDOS 8 Technical Reference Manual</i>	Standard Apple II operating system
<i>Apple IIGS ProDOS 16 Reference</i>	Apple IIGS operating system and loader
<i>Human Interface Guidelines</i>	Guidelines for the desktop interface
<i>Apple Numerics Manual</i>	Numerics for all Apple computers



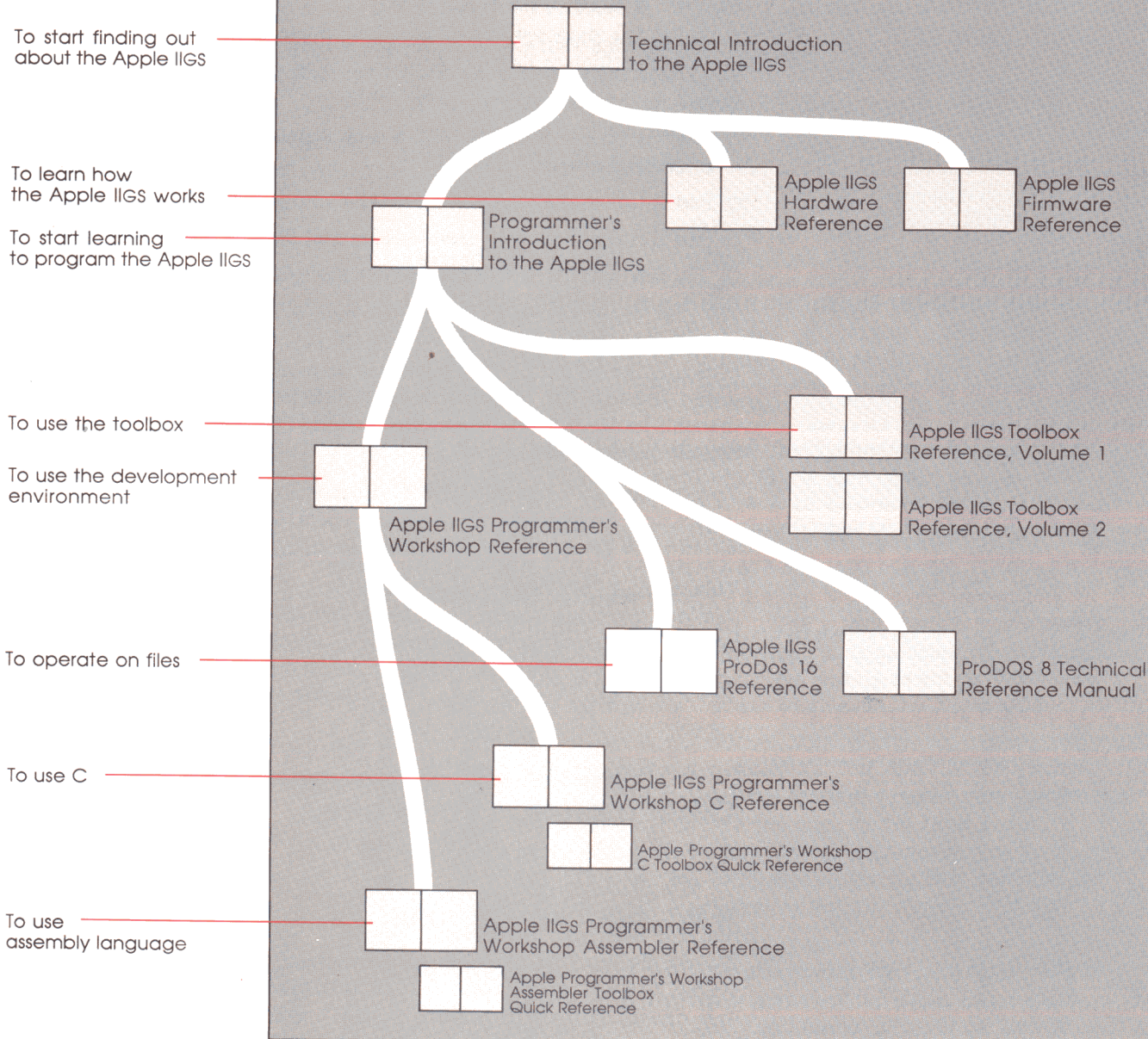

**Figure P-1**  
Roadmap to the technical manuals



---

---

## How to use this manual

The *Apple IIGS ProDOS 16 Reference* is both a reference manual and a learning tool. It is divided into several parts, to help you quickly find what you need.

- Part I describes ProDOS 16, the central part of the Apple IIGS operating system
- Part II lists and explains the ProDOS 16 operating system calls
- Part III describes the System Loader and lists all loader calls
- The final part consists of appendixes, a glossary, and an index

The first chapter in each part is introductory; read it first if you are not already familiar with the subject. The remaining chapters are primarily for reference, and need not be read in any particular order. The *ProDOS 16 Exerciser*, on a diskette included with the manual, provides a way to practice making ProDOS 16 calls before actually coding them.

This manual does not explain 65C816 assembly language. Refer to *Apple IIGS Programmer's Workshop Assembler Reference* for information on Apple IIGS assembly language programming.

This manual does not give a detailed description of ProDOS 8, the Apple II operating system from which ProDOS 16 was derived. For a synopsis of the differences between ProDOS 8 and ProDOS 16, see Chapter 1 of this manual. For more detailed information on ProDOS 8, see *ProDOS 8 Technical Reference Manual*.

---

---

## Other materials you'll need

---

### Hardware and software

To use the products described in this manual, you will need an Apple IIGS with at least one external disk drive (Apple recommends two drives). ProDOS 16 and the System Loader require only the minimum memory configuration (256K RAM), although Apple IIGS Programmer's Workshop and many application programs may require more memory.

You will also need an Apple IIGS system disk. A system disk contains ProDOS 16, ProDOS 8, the System Loader, and other system software necessary for proper functioning of the computer. A system disk may also contain application programs.

If you wish to practice making ProDOS 16 operating system calls you will need the ProDOS 16 *Exerciser*, a program on the diskette included with this manual.

---

## Publications

This manual is the only reference for ProDOS 16 and the System Loader. You may find useful related information in any of the publications listed under “Roadmap to Apple IIGS Technical Manuals” in this preface; in particular, you may wish to refer to the following:

- **The technical introduction:** The *Technical Introduction to the Apple IIGS* is the first book in the suite of technical manuals about the Apple IIGS. It describes all aspects of the Apple IIGS, including its features and general design, the program environments, the toolbox, and the development environment.
- **The programmer's introduction:** When you start writing programs for the Apple IIGS, the *Programmer's Introduction to the Apple IIGS* provides the concepts and guidelines you need. It is a starting point for programmers writing **event-driven** and segmented applications that use routines in the Apple IIGS Toolbox.
- **The firmware reference manual:** The *Apple IIGS Firmware Reference* describes the routines that are stored in the machine's read-only memory (ROM); it includes information about interrupt routines and low-level I/O subroutines for the serial ports and disk port. The *Firmware Reference* also describes the Monitor, a low-level programming and debugging aid for assembly-language programs.
- **The toolbox manuals:** Like the Macintosh™, the Apple IIGS has a built-in toolbox. The two volumes of the *Apple IIGS Toolbox Reference* introduce concepts and terminology, show how to use the tools, and tell how to write and install your own tool set. They also describe the workings of some of the system-level tool sets, such as the Memory manager, that interact closely with proDOS 16 and the System Loader.

- **The Programmer's Workshop manuals:** The development environment on the Apple IIGS is the Apple IIGS Programmer's Workshop (APW). APW is a set of programs that enable you to create and debug application programs on the Apple IIGS. The *Apple IIGS Programmer's Workshop Reference* includes information about the parts of the workshop that are independent of programming language: the shell, the editor, the linker, the debugger, and the utilities. In addition, there is a separate reference manual for each programming language. The manuals for the languages Apple provides are the *Apple IIGS Programmer's Workshop Assembler Reference* and the *Apple IIGS Programmer's Workshop C Reference*.
- **The ProDOS 8 manual:** ProDOS 8 (previously called just *ProDOS*) is compatible with all Apple II computers, including the Apple IIGS. As a developer of Apple IIGS programs, you may need to refer to the *ProDOS 8 Technical Reference Manual* if you are developing programs to run on standard Apple II's as well as on the Apple IIGS, or if you are converting a ProDOS 8-based program to run under ProDOS 16.

---

---

## Notations and conventions

To help make the manual more understandable, the following conventions and definitions apply throughout.

---

## Terminology

This manual may define certain terms, such as Apple II and ProDOS, slightly differently than what you are used to. Please note:

- **Apple II:** A general reference to the Apple II family of computers, especially those that may use ProDOS 8 or ProDOS 16 as an operating system. It includes the 64k Apple II Plus, the Apple IIc, the Apple IIe, and the Apple IIGS.
- **standard Apple II:** Any Apple II computer that is *not* an Apple IIGS. Since previous members of the Apple II family share many characteristics, it is useful to distinguish them as a group from the Apple IIGS. A standard Apple II may also be called an *8-bit Apple II*, because of the 8-bit registers in its 6502 or 65C02 microprocessor.

- **ProDOS:** A general term describing the family of operating systems developed for Apple II computers. It includes both ProDOS 8 and ProDOS 16; it does not include DOS 3.3 or SOS.
- **ProDOS 8:** The 8-bit ProDOS operating system, through version 1.2, originally developed for standard Apple II computers but compatible with the Apple IIGS. In previous Apple II documentation, ProDOS 8 is called simply *ProDOS*.
- **ProDOS 16:** A 16-bit operating system developed for the Apple IIGS computer. It is the system described in this manual.

---

## Typographic conventions

Each new term introduced in this manual is printed first in **bold** type. That lets you know that the term has not been defined earlier, and also indicates that there is an entry for it in the glossary.

Assembly language labels, entry points, routine names, and file names that appear in text passages are printed in a special typeface (for example, `name_length` and `GET_ENTRY`). Function names that are English language terms are printed with initial caps (for example, Load Segment By Number). When the name of a label or variable is used to mean the *value of* that variable rather than its name, the word is printed in italics (for example, “the first *name\_length* bytes of this field contain the volume name...”).

---

## Watch for these

The following words mark special messages to you:

- ❖ *Note:* Text set off in this manner—with a word or phrase such as *Note* or *By the way*—presents sidelights or interesting points of information.

---

**Important** Text set off in this manner—with the word **Important** —presents important information or instructions.

---

**Warning** Text set off in this manner—with the word **Warning** —indicates potential serious problems.

---





## Part I



# How ProDOS 16 Works

This part of the manual gives a general description of ProDOS 16. ProDOS 16 is the **disk operating system** for the Apple IIGS; it provides file management and input/output capabilities, and controls certain other aspects of the Apple IIGS **operating environment**.



# Chapter 1



## About ProDOS 16

This chapter introduces ProDOS 16. It gives background information on the development of ProDOS 16, followed by an overview of ProDOS 16 in relation to the Apple IIGS. A brief comparison of ProDOS 16 with ProDOS 8, its closest relative in the Apple II world, is followed by a reference list of the most pertinent ProDOS 16 features.

The chapter's organization roughly parallels that of Part I as a whole. Each section refers you to the appropriate chapter for more information on each aspect of ProDOS 16.

---

---

## Background

The Apple IIGS is the latest Apple II computer. Its microprocessor, the 65C816, is a successor to the standard Apple IIs' 6502 and functions in both 8-bit (6502 **emulation**) mode and 16-bit (**native**) mode (see *Technical Introduction to the Apple IIGS*). In accordance with the design philosophy governing all Apple II family products, the Apple IIGS is compatible with standard Apple II software—most presently available Apple II, Apple IIc, and Apple IIe applications will run without modification on the Apple IIGS.

To retain this compatibility while adding new features, the Apple IIGS requires two separate operating systems, ProDOS 8 and ProDOS 16:

- ProDOS 8 is the operating system for standard Apple II computers. The Apple IIGS uses ProDOS 8 and puts the processor into emulation mode in order to run standard–Apple II applications.
- ProDOS 16 is a newly developed system; it takes advantage of Apple IIGS features that standard Apple II computers do not have. The Apple IIGS uses ProDOS 16 and puts the processor into native mode in order to run Apple IIGS applications.

The user need not worry about which operating system is active at any one time. Whenever the Apple IIGS loads an application, it automatically loads the proper operating system for it.

ProDOS 8 on the Apple IIGS functions identically to ProDOS 8 on other Apple II computers. For a complete description of ProDOS 8, see *ProDOS 8 Technical Reference Manual*.

---

---

## What Is ProDOS 16?

ProDOS 16 is the central part, or **kernel**, of the Apple IIGS operating system. Although other software components (such as the System Loader described in this manual) may be thought of as parts of the overall operating system, ProDOS 16 is the key component. It manages the creation and modification of files. It accesses the **disk devices** on which the files are stored and retrieved. It dispatches interrupt signals to **interrupt handlers**. It also controls certain aspects of the Apple IIGS operating environment, such as pathname prefixes and procedures for quitting programs and starting new ones.

---

## Programming levels in the Apple IIGS

Figure 1-1 is a simplified logical diagram of the Apple IIGS, from a programmer's point of view. Boxes representing parts of the system form a vertical hierarchy; arrows between the boxes show the flow of control or execution from one level to the next. At the highest level is the programmer or user; he directly manipulates the execution of the application program that runs on the machine. The application, in turn, interacts directly with the next lower level of software—the operating system. The operating system interacts with the very lowest level of software in the machine: the built-in firmware and toolbox routines. Those routines directly manipulate the switches, registers, and input/output devices that constitute the computer's hardware.

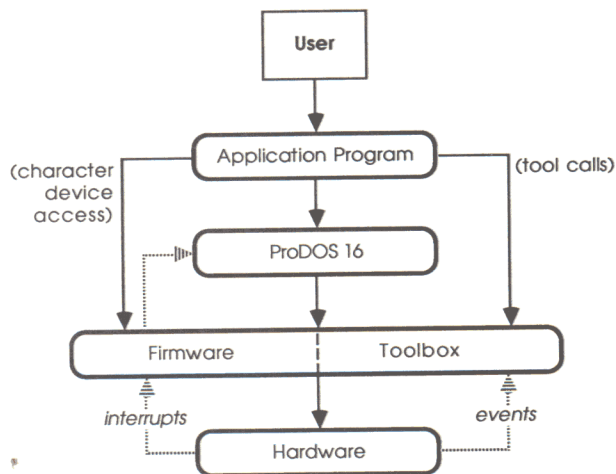

**Figure 1-1**  
Programming levels in the Apple IIGS

This hierarchical view shows that the operating system is an intermediary between the application program and the computer hardware. A program need not know the details of individual hardware devices it accesses; instead, it makes operating system **calls**. The operating system then translates those calls into the proper instructions for whatever devices are connected to the system.

The lowest software level, between the operating system and hardware, is extensively developed in the Apple IIGS. It consists of two parts: the **firmware**, a collection of traditional ROM-based routines for performing such tasks as character I/O, interrupt handling, and memory manipulation; and the **toolbox**, a large set of assembly-language routines and macros useful to all levels of software. As the arrows on Figure 1-1 show, ProDOS 16 accesses the firmware/tools level of the Apple IIGS directly, but so do application programs. In other words, for tool calls and certain types of I/O, applications *bypass* ProDOS 16 and interact directly with low-level system software.



The arrows pointing *upward* along the diagram show a counterflow of information, in which lower levels in the machine notify higher levels of important hardware conditions. **Interrupts** from hardware devices are handled both by firmware and by ProDOS 16; **events** are similar to interrupts but are handled by applications through tool calls.

---

## Disks, volumes, and files

ProDOS 16 communicates with several different types of disk drives, but the type of drive and its physical location (slot or port number) need not be known to a program that wants to access that drive. Instead, a program makes calls to ProDOS 16, identifying the disk it wants to access by its *volume name* or *device name*.

Information on a volume is divided into files. A **file** is an ordered collection of bytes that has several attributes, including a name and a file type. Files are either **standard files** (containing any type of code or data) or **directory files** (containing the names and disk locations of other files). When a disk is initially formatted, its **volume directory** file is created; the volume directory has the same name as the volume itself.

ProDOS 16 supports a **hierarchical file system**, meaning that volume directories can contain the names of either files or other directories, called **subdirectories**; subdirectories in turn can contain the names of files or other subdirectories. In a hierarchical file system, a file is identified by its **pathname**, a sequence of file names starting with the volume directory and ending with the name of the file. Figure 1-2 shows the relationships among files in a hierarchical file system.

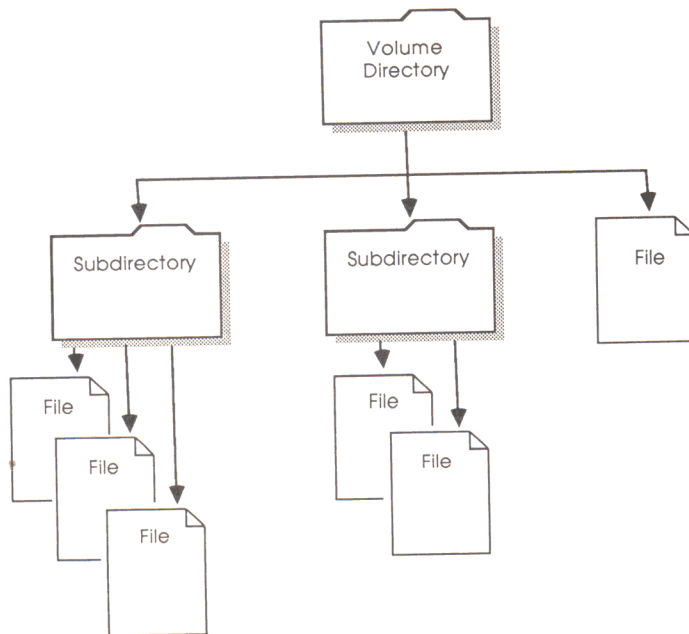

**Figure 1-2**  
Example of a hierarchical file structure

See Chapter 2 and Appendix A for detailed information on ProDOS 16's file structure, organization, and formats.

---

## Memory use

ProDOS 16 and application programs on the Apple IIGS are relieved of most memory management tasks. The Memory Manager, an Apple IIGS tool set, allocates all memory space, keeps track of available memory, and frees memory no longer needed by programs. If a program needs to allocate some memory space, it requests the space through a call to the Memory Manager. If a program makes a ProDOS 16 call that results in memory allocation, ProDOS 16 requests the space from the Memory Manager and allocates it to the program.

The Memory Manager is described further in Chapter 3 of this manual, and in *Apple IIGS Toolbox Reference*.

---

## External devices

ProDOS 16 communicates only with **block devices**, such as disk drives. Programs that wish to access **character devices** such as printers and communication ports must do so directly, either through the device firmware or through Apple IIGS Toolbox routines written for those devices. See *Apple IIGS Firmware Reference* and *Apple IIGS Toolbox Reference*.

Certain devices generate interrupts to tell the computer that the device needs attention. ProDOS 16 is able to handle up to 16 interrupting devices. You may place an interrupt-handling routine into service through a ProDOS 16 call; your routine will then be called each time an interrupt occurs. If you install more than one routine, the routines will be polled in the order in which they were installed.

You may also remove an interrupt routine with a ProDOS 16 call. In writing, installing, and removing interrupt handling routines, be sure to follow the conventions and requirements given in Chapter 7, “Adding Routines to ProDOS 16.”

---

---

## ProDOS 16 and ProDOS 8

ProDOS 16, although derived from ProDOS 8, adds several capabilities to support the new features and operating configurations of the Apple IIGS. For example:

- Because the 65C816 microprocessor functions in both 8-bit (emulation) and 16-bit (native) execution modes, ProDOS 16 is designed to accept system calls from applications running in either 8-bit or 16-bit mode. ProDOS 8 accepts system calls from applications running in 8-bit mode only.
- Because the Apple IIGS has a total addressable memory space of 16Mb, ProDOS 16 has the ability to accept system calls from anywhere in that memory space (addresses up to \$FF FFFF), and those calls can manipulate data anywhere in memory. Under ProDOS 8, system calls can be made from memory addresses below \$FFFF only—the lowest 64K of memory.

- ProDOS 16 relies on a sophisticated memory management system (see Chapter 3), instead of the simple global page bit map used by ProDOS 8.
- Applications under ProDOS 16 must make calls to allocate memory or to access system global variables, such as date and time, system level, and I/O buffer addresses. ProDOS 8 maintains that information in the system global page in memory bank \$00, but under ProDOS 16 the global page is not supported.
- ProDOS 16 also provides several programming conveniences not available under ProDOS 8, including named devices and multiple, user-definable file prefixes.

---

## Upward compatibility

In a strict sense, ProDOS 16 is not upwardly compatible from ProDOS 8. Programs written to function under ProDOS 8 on an Apple II will not run on the Apple IIGS, *under ProDOS 16*, without some modification. Conceptually, however, ProDOS 16 *is* upwardly compatible from ProDOS 8, in at least two ways:

1. The two operating systems are themselves similar in structure:
  - The set of ProDOS 16 system calls is a superset of the ProDOS 8 calls; for (almost) every ProDOS 8 system call, there is a functionally equivalent ProDOS 16 call, usually with the same name.
  - The calls are made in nearly identical ways in both ProDOS systems, and the parameter blocks for passing values to functions are laid out similarly.
  - ProDOS 16 uses exactly the same file system as ProDOS 8. It can read from and write to any disk volume produced by ProDOS 8.
2. Both operating systems are included with the Apple IIGS. Most applications written for ProDOS 8 on standard Apple II computers will run without modification on the Apple IIGS—not under ProDOS 16, but under ProDOS 8.

Thus, even though the individual operating systems are not completely compatible, their *sum* on the Apple IIGs computer is completely upwardly compatible from other Apple II computers. You never need be concerned with which operating system is functioning—if you run an Apple II application, ProDOS 8 is automatically loaded; if you run an Apple IIGS application, ProDOS 16 is automatically loaded. Chapter 5 explains the details of how this is accomplished.

---

## Downward compatibility

ProDOS 16 is not downwardly compatible to ProDOS 8. Applications written for ProDOS 16 will not run on the Apple II, IIc, or IIe. The extra memory needed by Apple IIGS applications and the additional instructions recognized by the 65C816 microprocessor make applications written for ProDOS 16 incompatible with standard Apple II computers.

---

## Eliminated ProDOS 8 system calls

As mentioned under “Upward Compatibility,” most ProDOS 8 calls have functionally exact equivalents in ProDOS 16. However, some ProDOS 8 calls do not appear in ProDOS 16 because they are unnecessary. The eliminated calls are

RENAME	The ProDOS 16 CHANGE_PATH call performs the same function.
GET_TIME	Under ProDOS 16, the time and date are obtained through a call to the Miscellaneous Tool Set (see <i>Apple IIGS Toolbox Reference</i> ).
SET_BUF	Under ProDOS 16, the Memory Manager, rather than the application, allocates file I/O buffers.
GET_BUF	This call is unnecessary under ProDOS 16 because the OPEN call returns a handle to the file's I/O buffer.
ONLINE	This call is replaced in ProDOS 16 by the VOLUME call.



---

## New ProDOS 16 system calls

The following operating system calls, not recognized by ProDOS 8, are part of ProDOS 16:

CLEAR_BACKUP_BIT	(clears one of a file's access bits)
CHANGE_PATH	(changes the pathname of a file within a volume)
SET_LEVEL	(sets the system file level)
GET_LEVEL	(returns the system file level)
GET_DEV_NUM	(returns the device number for a named device)
GET_LAST_DEV	(returns the number of the last device accessed)
FORMAT	(formats a disk volume)
GET_NAME	(returns the filename of the current application)
GET_BOOT_VOL	(returns the name of the volume that contains ProDOS 16)
GET_VERSION	(returns the current ProDOS 16 version)

These and all other ProDOS 16 calls are described in detail in Chapters 9 through 13.

---

## Other features

Like ProDOS 8, ProDOS 16 supports block devices only. It does not support I/O operations for the built-in serial ports, mouse, Apple Desktop Bus™, sound generation system, or any other nonblock device. Applications must access these devices through the device firmware or the Apple IIGS Toolbox.

ProDOS 8 and ProDOS 16 have identical file structures. Each can *read* the other's files, but

- ProDOS 16 load files (types \$B3 - \$BE) cannot be executed under ProDOS 8
- ProDOS 8 system files (type \$FF) or binary files (type \$06) cannot be executed under ProDOS 16

The default operating system on the Apple IIGS (after a cold or warm restart) can be either ProDOS 8 or ProDOS 16, depending on the organization of files on the startup disk. See “System Startup” in Chapter 5.

Running under ProDOS 8 does not disable memory beyond the addresses ProDOS 8 can reach, nor does it disable any other advanced Apple IIGS features. All system resources are always available, even though an application itself may make use of only the “ProDOS 8–standard Apple II” portion.

---

---

## Summary of ProDOS 16 features

The following lists summarize the principal features of ProDOS 16. Refer to the glossary and to appropriate chapters for definitions and explanations of terms that may be unfamiliar to you.

### In general, ProDOS 16...

- is a single-task operating system
- supports a hierarchical, tree-structured file system
- allows device-independent I/O for block devices

### ProDOS 16 system calls...

- use the JSL instruction and a parameter block
- return error status in the A and P registers
- preserve all other CPU registers
- can be made from 65C816 native mode or 6502 emulation mode
- can be made from anywhere in memory
- can access parameter blocks that are anywhere in memory
- can use pointers that point anywhere in memory
- can transfer data anywhere in memory

### **The ProDOS 16 file management system...**

- uses a hierarchical file structure
- supports 9 pathname prefixes
- allows byte-oriented access to both directory files and data files
- allocates files dynamically and noncontiguously on block devices
- supports sparse files
- provides buffers automatically
- supports access attributes that enable/disable
  - reading
  - writing
  - renaming
  - destroying
  - backup
- assigns a system file level to open files
- automatically marks files with date and time
- uses a 512-byte block size
- allows volume sizes up to 32 megabytes
- allows data file sizes up to 16 megabytes
- allows up to 14 volumes on line
- allows up to 8 open files
- allows 64 characters per pathname
- allows 64-character prefixes
- allows 15 characters per volume name
- allows 15 characters per file name

### **The ProDOS 16 device management system...**

- supports the ProDOS block device protocol
- names each block device
- allows 15 characters per device name
- allows 14 devices on line simultaneously
- provides a FORMAT call to initialize disks

### **The ProDOS 16 interrupt management system...**

- receives hardware interrupts not handled by firmware
- dispatches interrupts to user-provided interrupt handlers
- allows installation of up to 16 interrupt handlers

### **For memory management, ProDOS 16...**

- dynamically allocates and releases system buffers (through the Memory Manager)
- can directly access up to  $2^{24}$  bytes (16 megabytes) of memory
- can run with a minimum of 256K memory

### **In addition, ProDOS 16...**

- provides a QUIT call to cleanly exit one program and start another, with the option of returning later to the quitting program



## Chapter 2



### ProDOS 16 Files



The largest part of ProDOS 16 is its file management system. This chapter explains how files are named, how they are created and used, and a little about how they are organized on disks. It discusses ProDOS 16 *file access* and *file housekeeping* calls.

For more details on file format and organization, see Appendix A.

---

---

## Using files

---

### Filenames

Every ProDOS 16 file, whether it is a directory file, data file, or program file, is identified by a **filename**. A ProDOS 16 filename can be up to 15 characters long. It must begin with a letter, and may contain uppercase letters (A-Z), digits (0-9), and periods (.). Lowercase letters are automatically converted to uppercase. A filename must be unique within its directory. Some examples (taken from Figure 2-1) are

```
MEMOS  
CHAP11  
MY.PROGRAM
```

An entire disk is identified by its **volume name**, which is the filename of its volume directory. In Figure 2-1, the disk's volume name is /DISK86.

---

## Pathnames

A ProDOS 16 pathname is a series of filenames, each preceded by a slash (/). The first filename in a pathname is the name of a volume directory. Successive filenames indicate the path, from the volume directory to the file, that ProDOS 16 must follow to find a particular file. The maximum length for a pathname is 64 characters, including slashes. Examples from Figure 2-1 are

```
/DISK86/CHARTS/SALES.JUN  
/DISK86/MY.PROGRAM  
/DISK86/MEMOS/CHAP11
```

All calls that require you to name a file will accept either a full pathname or a **partial pathname**. A partial pathname is a portion of a pathname; you can tell that it is not a full pathname because it doesn't begin with a slash and a volume name. The maximum length for a partial pathname is 64 characters, including slashes.

These partial pathnames are all derived from the sample pathnames above:

```
SALES.JUN  
MY.PROGRAM  
MEMOS/CHAP11  
CHAP11
```

ProDOS 16 automatically adds a **prefix** to the front of partial pathnames to form full pathnames. A prefix is a pathname that indicates a directory; it always begins with a slash and a volume name. Several prefixes are stored internally by ProDOS 16.

For the partial pathnames listed above to indicate the proper files, their prefixes should be set to

```
/DISK86/CHARTS/  
/DISK86/  
/DISK86/  
/DISK86/MEMOS/
```

respectively. The slashes at the end of these prefixes are optional; however, they are convenient reminders that prefixes indicate directory files.

The maximum length for a prefix is 64 characters. The minimum length for a prefix is zero characters, known as a **null prefix**. You set and read prefixes using the calls `SET_PREFIX` and `GET_PREFIX`.

❖ *Note:* Because both a prefix and a partial pathname can be up to 64 characters long, it is possible to have a pathname (prefix plus partial pathname) whose *effective* length is up to 128 characters.

ProDOS 16 allows you to set more than one prefix, and then refer to each prefix by code numbers. When, as in the above examples, no particular prefix number is specified, ProDOS 16 adds the **default prefix** to the partial pathname you provide. See Chapter 5 for a more complete explanation and examples.

Figure 2-1 illustrates a hypothetical directory structure; it contains all the files mentioned above. Note that, even though there are two files named PROFIT.3RD in the volume directory /DISK.86/, they are easily distinguished because they are in different subdirectories (MEMOS/ and CHARTS/). That is why a full pathname is necessary to completely specify a file.

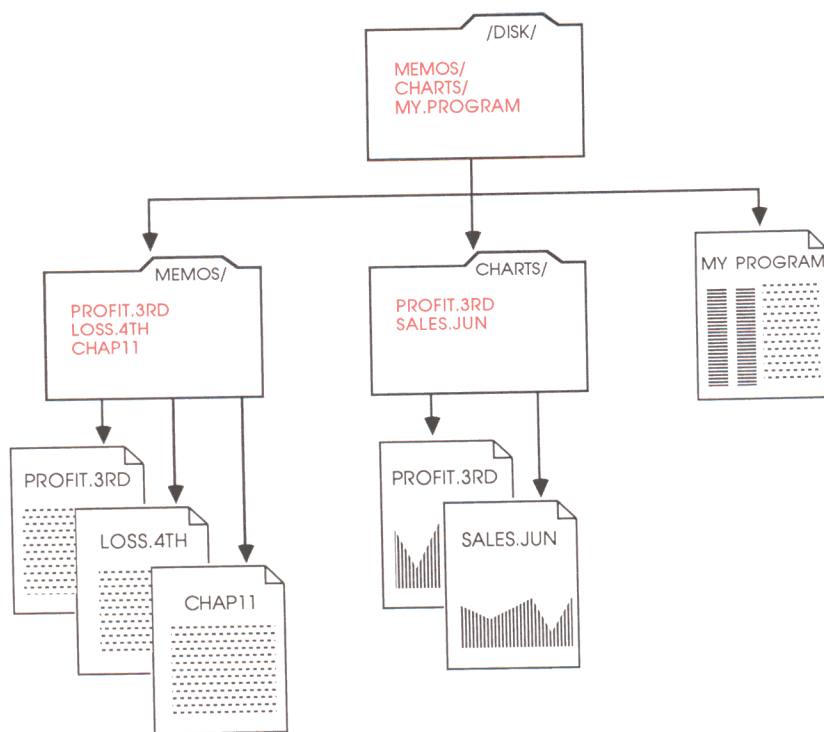

**Figure 2-1**  
Example of a ProDOS 16 file structure

---

## Creating files

A file is placed on a disk by the `CREATE` call. When you create a file, you assign it the following properties:

- A **pathname**. This pathname is a unique path by which the file can be identified and accessed. This pathname must place the file within an existing directory.
- An **access byte**. The value of this byte determines whether or not the file can be written to, read from, destroyed, or renamed.
- A **file type**. This byte indicates to other applications the type of information to be stored in the file. It does not affect, in any way, the contents of the file.
- A **storage type**. This byte determines the physical format of the file on the disk. There are only two different formats: one is used for directory files, the other for non-directory files.

When you create a file, the properties listed above are placed on the disk, along with the current system date and time (called **creation date** and **creation time**), in a format as shown in Appendix A. Once a file has been created, it remains on the disk until it is deleted (using the `DESTROY` call).

To check what the properties for a given file are, use the `GET_FILE_INFO` call. To alter its properties, use the `SET_FILE_INFO` call. To change the file's name, use the `CHANGE_PATH` call.

---

## Opening files

Before you can read information from or write information to a file that has been created, you must use the `OPEN` call to open the file for access. When you open a file you specify it by pathname. The pathname you give must indicate an existing file; the file must be on a disk mounted in a disk drive.

The `OPEN` call returns a reference number (*ref\_num*) and the location of a buffer (*io\_buffer*) to be used for transferring data to and from the file. All subsequent references to the open file must use its reference number. The file remains open until you use the `CLOSE` call.

Each open file's I/O buffer is used by the system the entire time the file is open. Thus, to conserve memory space, it is wise to keep as few files open as possible. ProDOS 16 allows a maximum of 8 open files at a time.

When you open a file, some of the file's characteristics are placed into a region of memory called a **file control block**. Several of these characteristics—the location in memory of the file's buffer, a pointer to the end of the file (the **EOF**), and a pointer to the current position in the file (the **Mark**)—are accessible to applications via ProDOS 16 calls, and may be changed while the file is open.

It is important to be aware of the differences between the file as it exists on the disk and when it is open in memory. Although some of the file's characteristics and some of its data may be in memory at any given time, the file itself still resides on the disk. This allows ProDOS 16 to manipulate files that are much larger than the computer's memory capacity. As an application writes to the file and changes its characteristics, new data and characteristics are written to the disk.

---

## The EOF and Mark

To aid reading from and writing to files, each open file has one pointer indicating the end of the file (the EOF), and another defining the current position in the file (the Mark). ProDOS 16 moves both EOF and Mark automatically when necessary, but an application program can also move them independently of ProDOS 16.

The EOF is the number of readable bytes in the file. Since the first byte in a file has number 0, the EOF, when treated as a pointer, points one position past the last character in the file.

When a file is opened, the Mark is set to indicate the first byte in the file. It is automatically moved forward one byte for each byte written to or read from the file. The Mark, then, always indicates the next byte to be read from the file, or the next byte position in which to write new data. It cannot exceed the EOF.



If during a write operation the Mark meets the EOF, both the Mark and the EOF are moved forward one position for every additional byte written to the file. Thus, adding bytes to the end of the file automatically advances the EOF to accommodate the new information. Figure 2-2 illustrates the relationship between the Mark and the EOF.

(a.) Beginning position

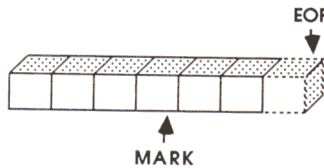

(b.) After writing or reading two bytes:

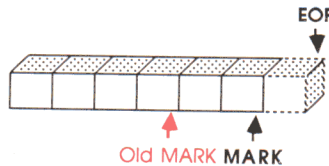

(c.) After writing two more bytes:

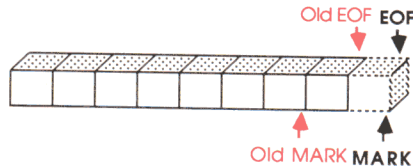

**Figure 2-2**  
Automatic movement of EOF and Mark

An application can place the EOF anywhere, from the current Mark position to the maximum possible byte position. The Mark can be placed anywhere from the first byte in the file to the EOF. These two functions can be accomplished using the SET\_EOF and SET\_MARK calls. The current values of the EOF and the Mark can be determined using the GET\_EOF and GET\_MARK calls.

---

## Reading and writing files

READ and WRITE calls to ProDOS 16 transfer data between memory and a file. For both calls, the application must specify three things:

- The reference number of the file (assigned when the file was opened).
- The location in memory of a buffer (`data_buffer`) that contains, or is to contain, the transferred data. Note that this cannot be the same buffer (`io_buffer`) whose location was returned when the file was opened.
- The number of bytes to be transferred.

When the request has been carried out, ProDOS 16 passes back to the application the number of bytes that it actually transferred.

A read or write request starts at the current Mark, and continues until the requested number of bytes has been transferred (or, on a read, until the end-of-file has been reached). Read requests can also terminate when a specified character is read. To turn on this feature and set the character(s) on which reads terminate, use the NEWLINE call. The newline read mode is typically used for reading lines of text that are terminated by carriage returns.

- ❖ *By the way:* Neither a READ nor a WRITE call necessarily causes a disk access. ProDOS I/O buffer for each open file is 1024 bytes in size, and can hold one block (512 bytes) of data; it is only when a read or write crosses a block boundary that a disk access occurs.

---

## Closing and flushing files

When you finish reading from or writing to a file, you must use the CLOSE call to close the file. When you use this call, you specify only the reference number of the file (assigned when the file was opened).

CLOSE writes any unwritten data from the file's I/O buffer to the file, and it updates the file's size in the directory, if necessary. Then it frees the 1024-byte buffer space for other uses and releases the file's reference number and file control block. To access the file once again, you have to reopen it.

Information in the file's directory, such as the file's size, is normally updated only when the file is closed. If the user were to press Control-Reset (typically halting the current program) while a file is open, data written to the file since it was opened could be lost, and the integrity of the disk could be damaged. This can be prevented by using the FLUSH call.

FLUSH, like CLOSE, writes any unwritten data from the file's I/O buffer to the file, and updates the file's size in the directory. However, it keeps the file's buffer space and reference number active, and allows continued access to the file. In other words, the file stays open. If the user presses Control-Reset while an open but flushed file is in memory, there is no loss of data and no damage to the disk.

Both the CLOSE and FLUSH calls, when used with a reference number of 0, normally cause all open files to be closed or flushed. Specific groups of files can be closed or flushed using the *system file level* (see next).

---

## File levels

When a file is opened, it is assigned a level, according to the value of a specific byte in memory (the **system file level**). If the file level is never changed, the CLOSE and FLUSH calls, when used with a reference number of 0, cause all open files to be closed or flushed. But if the level has been changed since the first file was opened, only those files opened when the file was greater than or equal to the current system file level are closed or flushed.

The system file level feature may be used, for example, by a controlling program such as a BASIC interpreter to implement an EXEC command:

1. The interpreter opens an EXEC program file when the level is \$00.
2. The interpreter then sets the level to, say, \$07.
3. The EXEC program opens whatever files it needs.
4. The EXEC program executes a BASIC CLOSE command, to close all the files it has opened. All files at or above level \$07 are closed, but the EXEC file itself remains open.

You assign a value to the system file level with a SET\_LEVEL call; you obtain the current value by making a GET\_LEVEL call.

---

---

## File format and organization

This portion of the chapter describes in general terms the organization of files on a disk. For more detailed information, see Appendix A.

In general, *structure* refers in this manual to the hierarchical relationships among files—directories, subdirectories, and files. *Format* refers to the arrangement of information (such as headers, pointers and data) within a file. *Organization* refers to the manner in which a single file is stored on disk, in terms of individual 512-byte **blocks**. The three concepts are separate but interrelated. For example, because of ProDOS 16's hierarchical file *structure*, part of the *format* of a directory file includes pointers to the files within that directory. Also, because files are *organized* as noncontiguous blocks on disk, part of the *format* of every file larger than one block includes pointers to other blocks.

---

### Directory files and standard files

Every ProDOS 16 file is a named, ordered sequence of bytes that can be read from, and to which the rules of Mark and EOF apply. However, there are two types of files: **directory files** and **standard files**. Directory files are special files that describe and point to other files on the disk. They may be read from, but not written to (except by ProDOS 16). All nondirectory files are standard files. They may be read from and written to.

A directory file contains a number of similar elements, called *entries*. The first entry in a directory file is the header entry: it holds the name and other properties (such as the number of files stored in that directory) of the directory file. Each subsequent entry in the file describes and points to some other file on the disk. Figure 2-3 shows the format of a directory file.

The files described and pointed to by the entries in a directory file can be standard files or other directory files.

An application does not need to know the details of directory format to access files with known names. Only operations on unknown files (such as listing the files in a directory) require the application to examine a directory's entries. For such tasks, refer to Appendix A.

Standard files have no such predefined internal format: the arrangement of the data depends on the specific file type.

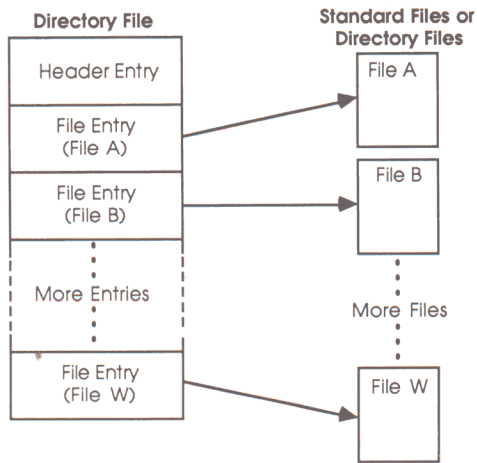

**Figure 2-3**  
Directory file format

---

## File organization

Because directory files are generally smaller than standard files, and because they are sequentially accessed, ProDOS 16 uses a simpler form of storage for directory files than it does for standard files. Both types of files are stored as a set of 512-byte blocks, but the way in which the blocks are arranged on the disk differs.

A directory file is a linked list of blocks: each block in a directory file contains a pointer to the next block in the directory file as well as a pointer to the previous block in the directory. Figure 2-4 illustrates this organization.



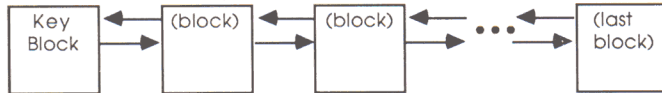

**Figure 2-4**  
Block organization of a directory file

Data files, on the other hand, are often quite large, and their contents may be randomly accessed. It would be very slow to access such large files if they were organized sequentially. Instead, ProDOS 16 stores standard files using a **tree organization**. The largest possible standard file has a **master index block** that points to 128 **index blocks**. Each index block points to 256 **data blocks** and each data block can hold 512 bytes of data. The block organization of the largest possible standard file is shown in Figure 2-5.

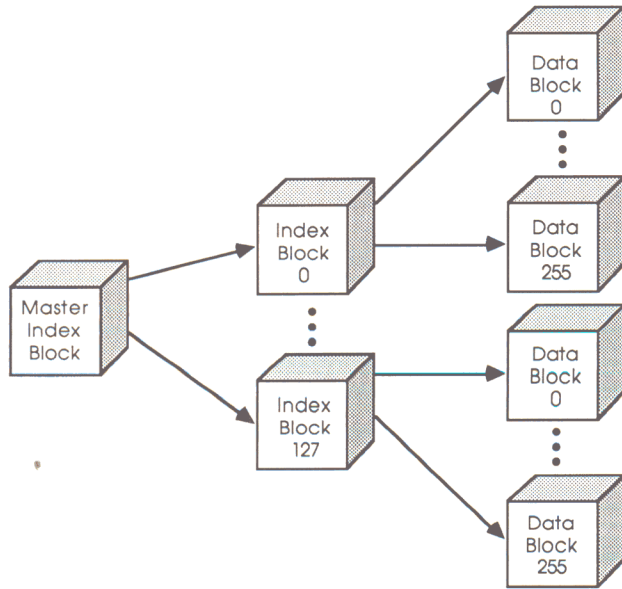

**Figure 2-5**  
Block organization of a standard file

Most standard files do not have this exact organization. ProDOS 16 only writes a subset of this form to the file, depending on the amount of data written. This technique produces three distinct forms of standard file: seedling, sapling, and tree files. All three are explained in Appendix A.

---

## Sparse files

In most instances a program writes data sequentially into a file. But by writing data, moving the EOF and Mark, and then writing more data, a program can also write nonsequential data to a file. For example, a program can open a file, write a few characters of data, and then move the EOF and Mark (thereby making the file bigger) by an arbitrary amount before writing a few more bytes of data. Only those blocks that contain nonzero information are actually allocated for the file, so it may take up as few as three blocks on the disk (a total of 1536 bytes). However, as many bytes as are specified by the value of EOF (up to 16 megabytes) can potentially be read from it. Such files are known as **sparse files**. Sparse files are explained in more detail in Appendix A.

---

### Important

In transferring sparse files, the fact that more data can be read from the file than actually resides on the disk can cause a problem. Suppose that you were trying to copy a sparse file from one disk to another. If you were to read data from one file and write it to another, the new file would be much larger than the original because data that is not actually on the disk can be read from the file. Thus if your application is going to transfer sparse files, you must use the information in Appendix A to determine which blocks should be copied, and which should not.

---

The file utility programs supplied with the Apple IIGS automatically preserve the structure of sparse files on a copy.



## Chapter 3



# ProDOS 16 and Apple IIGs Memory

Strictly speaking, memory management is separate from the operating system in the Apple IIGS. This chapter shows how ProDOS 16 uses memory and how it interacts with the Memory Manager.

## Apple IIGS memory configurations

The Apple IIGS microprocessor is capable of directly addressing 16 megabytes (16Mb) of memory. As shipped, the basic memory configuration for Apple IIGS is 256 kilobytes (256K) of RAM and 128K of ROM, arranged within the 16Mb memory space as shown in Figure 3-1.

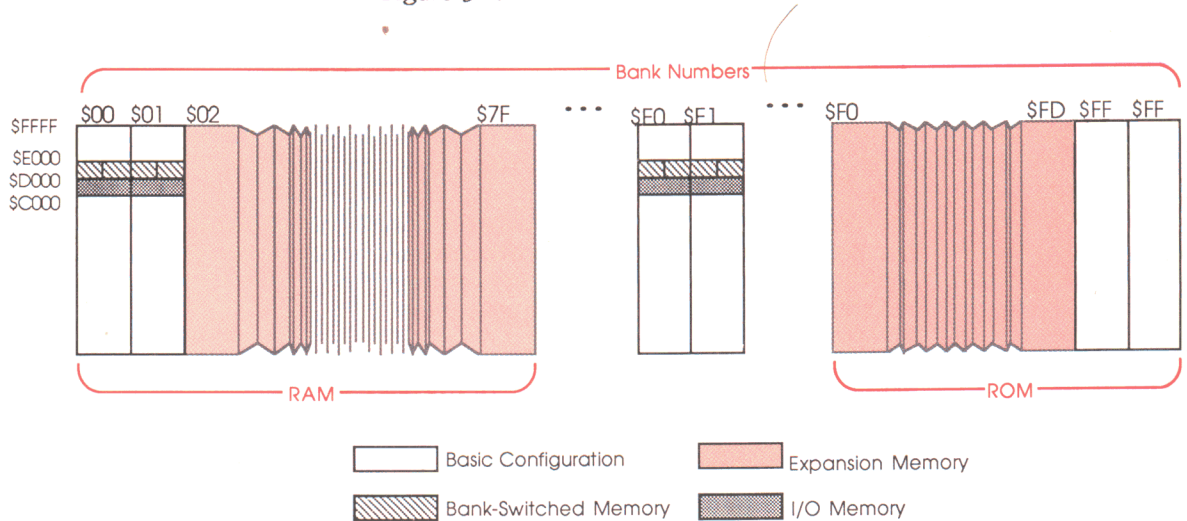

**Figure 3-1**  
Apple IIGS memory map



The total memory space is divided into 256 **banks** of 64K bytes each (see Table 3-1). Banks \$00 and \$01 are used for system software, ProDOS 16 applications, and are the only memory space occupied by standard-Apple II programs running under ProDOS 8. Banks \$E0 and \$E1 are used principally for high-resolution video display, additional system software, and RAM-based tools. Specialized areas of RAM in these banks include I/O space, bank-switched memory, and display buffers in locations consistent with standard Apple II memory configurations (see “Special Memory and Shadowing,” below). Banks \$FF and \$FE are ROM; they contain firmware and ROM-based tools. For more detailed pictures of Apple IIGS Memory, see *Technical Introduction to the Apple IIGS*, *Apple IIGS Hardware Reference* and *Apple IIGS Firmware Reference*.

**Table 3-1**  
Apple IIGS memory units

Unit	Size
nibble	4 bits (one-half byte)
byte	8 bits
word	2 bytes
long word	4 bytes
page	256 bytes
block	512 bytes (for disk storage)
bank	65,536 bytes (256 pages)

With a 1-megabyte Apple IIGS Memory Expansion Card, 16 additional banks of memory are made available; they are numbered sequentially, from \$02 to \$11. Expansion banks have none of the specialized memory areas shown for banks \$00-\$01 and \$E0-\$E1—all 64K bytes in each bank are available for applications.

---

## Special memory and shadowing

For running standard Apple II software, the Apple IIGS memory configuration is set so that banks \$00 and \$01 are identical to the Main and Auxiliary RAM and ROM on an Apple IIc or an Apple IIe with extended 80-column card. See *Apple IIc Technical Reference Manual* or *Apple IIe Technical Reference Manual* for details. Because they are used by standard Apple II programs, both banks \$00 and \$01, as well as the display pages in banks \$E0 and \$E1, are called **special memory**; there are restrictions on the placement of certain types of code in special memory. For example, any system software that must remain active in the standard Apple II configuration cannot be put in special memory. See "Memory Manager" in *Apple IIGS Toolbox Reference* for more details.

**Shadowing** is the term used to describe a process whereby any changes made to one part of the Apple IIGS memory are automatically and simultaneously made in another part. Shadowing is necessary because standard Apple II programs can directly access banks \$00 and \$01 only, but all the fixed locations and data structures needed by those programs are maintained in banks \$E0 and \$E1 (see *Apple IIGS Hardware Reference*). When the proper shadowing is on, an application may, for example, update a display location in bank \$00; that information is automatically shadowed to bank \$E0, from where the video display is actually controlled.

---

## ProDOS 16 and System Loader memory map

ProDOS 16 and the System Loader together occupy nearly all addresses from \$D000 through \$FFFF in both banks \$00 and \$01. This is the same memory space that ProDOS 8 occupies in a standard Apple II: all of the language card area (addresses above \$D000), including most of bank-switched memory.

In addition, ProDOS 16 reserves (through the Memory Manager) approximately 10.7K bytes just below \$C000 in bank \$00 (in the region normally occupied by BASIC.SYSTEM in a standard Apple II), for I/O buffers, ProDOS 8 interface tables, and other code.

The part of ProDOS 16 that controls loading of both ProDOS 16 and ProDOS 8 programs is located in parts of bank-switched memory in banks \$E0 and \$E1. Other system software occupies most of the rest of the language card areas of banks \$E0 and \$E1.

None of these reserved memory areas is available for use by applications.

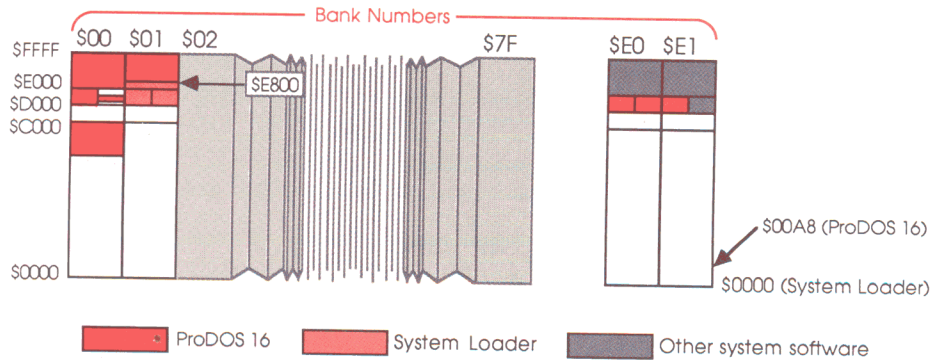

**Figure 3-2**  
ProDOS 16 and System Loader memory map

### Entry points and fixed locations

Because most Apple IIGS memory blocks are movable and under the control of the Memory Manager (see next section), there are very few fixed entry points available to applications programmers. References to fixed entry points in RAM are strongly discouraged, since they are inconsistent with flexible memory management and **are sure to cause compatibility problems in future versions of the Apple IIGS.** Informational system calls and referencing by handles (see “Pointers and Handles” in this chapter) should take the place of access to fixed entry points.

The single supported System Loader entry point is  $\$E1\ 0000$ . That location is the entry point for all Apple IIGS tool calls.

The single supported ProDOS 16 entry point is  $\$E1\ 00A8$ . That location is the entry point for all ProDOS 16 calls. In addition, ProDOS 16 supports a few other fixed locations in its bank  $\$E1$  vector space. Table 3-2 lists them.

**Table 3-2**  
ProDOS 16 fixed locations

Address range	Explanation
\$E1 00A8 – \$E1 00AB	Entry vector for all ProDOS 16 system calls
\$E1 00AC – \$E1 00B9	(reserved)
\$E1 00BA – \$E1 00BB	Two null bytes (guaranteed to be zeros)
\$E1 00BC	OS_KIND byte—indicates the currently running operating system: \$00 = ProDOS 8 \$01 = ProDOS 16
\$E1 00BD	OS_BOOT byte—indicates the operating system that was initially booted: \$00 = ProDOS 8 \$01 = ProDOS 16
\$E1 00BE – \$E1 00BF	Flag word. The bits are defined as follows: bit 15 (ProDOS busy flag): 0 = ProDOS 16 is not busy 1 = ProDOS 16 is busy Bits 14 – 0: (reserved)

The ProDOS busy flag is explained under “Making Operating System Calls During Interrupts,” in Chapter 7.

❖ *Note:* ProDOS 16 does *not* support the ProDOS 8 global page or any other fixed locations used by ProDOS 8.

---



---

## Memory management

ProDOS 16 itself does no memory management. All allocation and deallocation of memory in the Apple IIGS is performed by the **Memory Manager**. The Memory Manager is an Apple IIGS tool set; for a complete description of its functions, see *Apple IIGS Toolbox Reference*.



## The Memory Manager

The Memory Manager is a ROM-resident Apple IIGS tool set that controls the allocation, deallocation, and repositioning of memory blocks in the Apple IIGS. It works closely with ProDOS 16 and the System Loader to provide the needed memory spaces for loading programs and data and for providing buffers for input/output. All Apple IIGS software, including the System Loader and ProDOS 16, must obtain needed memory space by making requests (calls) to the Memory Manager.

The Memory Manager keeps track of how much memory is free and what parts are allocated to whom. Memory is allocated in **blocks** of arbitrary length; each block possesses several attributes that describe how the Memory Manager may modify it (such as moving it or deleting it), and how it must be aligned in memory (for example, on a page boundary). Table 3-3 lists the Memory Manager attributes that a memory block has.

**Table 3-3**  
Memory block attributes

Attribute	Explanation
fixed (yes/no)	Must the block remain at the same location in memory?
fixed address (yes/no)	Must it be at a specific address?
fixed bank (yes/no)	Must it be in a particular memory bank?
bank-boundary limited (yes/no)	It is prohibited from extending across a bank boundary?
special memory not usable (yes/no)	Is it prohibited from residing in special memory (banks \$00, \$01, and parts of banks \$E0, \$E1)?
page-aligned (yes/no)	Must it be aligned to a page boundary?
purge level (0 to 3)	Can it be purged? If so, with what priority?
locked (yes/no)	Is the block locked (temporarily fixed and un purgeable)?

Each block is also defined by its **User ID**, a code number that shows what program owns it.



Besides creating and deleting memory blocks, the Memory Manager moves blocks when necessary to consolidate free memory. When it **compacts** memory in this way, it of course can move only those blocks that needn't be fixed in location. Therefore as many memory blocks as possible should be movable (not fixed), if the Memory Manager is to be efficient in compaction.

When a memory block is no longer needed, the memory Manager either **purges** it (deletes its contents but maintains its existence) or **disposes** it (completely removes it from memory).

---

## Pointers and handles

To access an entry point in a movable block, an application cannot use a simple pointer, since the Memory Manager may move the block and change the entry point's address. Instead, each time the Memory Manager allocates a memory block, it returns to the requesting application a **handle** referencing that block.

A handle is a pointer to a pointer; it is the address of a fixed (nonmovable) location, called the **master pointer**, that contains the address of the block. If the Memory Manager changes the location of the block, it updates the address in the master pointer; the value of the handle itself is not changed. Thus the application can continue to access the block using the handle, no matter how often the block is moved in memory. Figure 3-3 illustrates the difference between a pointer and a handle.

If a block will always be fixed in memory (**locked** or **unmovable**), it can be referenced by a pointer instead of by its handle. To obtain a pointer to a particular block or location, an application can **dereference** the block's handle. The application reads the address stored in the location pointed to by the handle—that address is the pointer to the block. Of course, if the block is ever moved that pointer is no longer valid.

ProDOS 16 and the System Loader use both pointers and handles to reference memory locations. Pointers and handles must be at least three bytes long to access the full range of Apple IIGS memory. However, all pointers and handles used as parameters by ProDOS 16 are four bytes long, for ease of manipulation in the 16-bit registers of the 65C816 microprocessor.

**a. Pointer:**

Value of pointer =  
starting address of memory block



**b. Handle:**

Value of handle =  
address of master pointer



Value of master pointer =  
current starting address of  
memory block

**Figure 3-3**  
Pointers and handles

---

## How an application obtains memory

Normal memory allocation and deallocation is completely automatic, as far as applications are concerned. When an application makes a ProDOS 16 call that requires allocation of memory (such as opening a file or writing from a file to a memory location), ProDOS 16 first obtains any needed memory blocks from the Memory Manager and then performs its tasks. Likewise, the System Loader requests any needed memory either directly or indirectly (through ProDOS 16 calls) from the Memory Manager. Conversely, when an application informs the operating system that it no longer needs memory, that information is passed on to the Memory Manager which in turn frees that application's allocated memory.

Any other memory that an application needs for its own purposes must be requested directly from the Memory Manager. The shaded areas in Figure 3-3 show which parts of the Apple IIGS memory can be allocated through requests to the Memory Manager. Applications for Apple IIGS should avoid requesting absolute (fixed-address) blocks. Chapters 6 and 16 of this manual discuss program memory management further; see also *Programmer's Introduction to the Apple IIGS* and *Apple IIGS Toolbox Reference*.

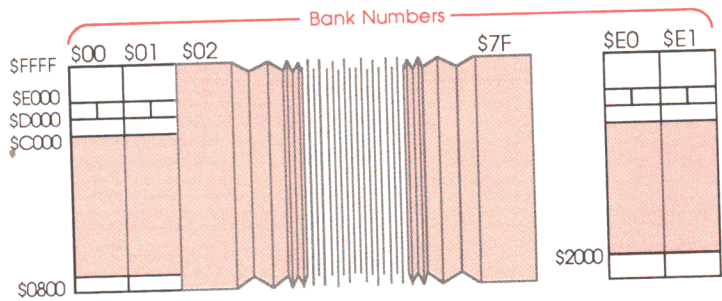

**Figure 3-4**  
Memory allocatable through the Memory Manager



## Chapter 4



# ProDOS 16 and External Devices

An **external device** is a piece of equipment that transfers information to or from the Apple IIGS. Disk drives, printers, mice, and joysticks are external devices. The keyboard and screen are also considered external devices. An *input* device transfers information to the computer, an *output* device transfers information from the computer, and an *input/output* device transfers information both ways.

This chapter discusses how ProDOS 16 provides an interface between applications and certain external devices.

---

---

## Block devices

A **block device** reads and writes information in multiples of one block of characters (512 bytes; see Table 3-1) at a time. Furthermore, it is a *random-access* device—it can access any block on demand, without having to scan through the preceding or succeeding blocks. Block devices are usually used for storage and retrieval of information, and are usually input/output devices. Disk drives are block devices.

ProDOS 16 supports access to block devices. That is, you may read from or write to a block device by making ProDOS 16 calls. In addition to READ, WRITE, and the other file calls described in Chapter 2, ProDOS 16 also provides five “lower-level” device-access calls. These calls allow you to access information on a block device without considering what files the information is in. The calls are

GET_DEV_NUM	returns the device number associated with a particular named device or online volume
GET_LAST_DEV	returns the device number of the last device accessed through ProDOS 16
READ_BLOCK	reads one block (512 bytes) of data from a specified device
WRITE_BLOCK	writes one block (512 bytes) of data to a specified device
FORMAT	formats (initializes) a volume in a device



A block device generally requires a **device driver** to translate ProDOS 16's *logical* block device model into the **tracks** and **sectors** by which information is actually stored on the *physical* device. The device driver may be circuitry within the disk drive itself (UniDisk™ 3.5), it may be included as part of ProDOS 16 (Disk II®), or it may be on a separate card in an expansion slot. This manual does not discuss device drivers.

- ❖ *Note on RAM disks:* RAM disks are internal software constructs that the operating system treats like external devices. Although ProDOS 16 provides no particular support for RAM disks, any RAM disk that behaves like a block device in all respects will be supported just as if it were an external device.

---

---

## Character devices

A **character device** reads or writes a stream of characters in order, one at a time. It is a **sequential-access** device—it cannot access any position in a stream without first accessing all previous positions. It can neither skip ahead nor go back to a previous character. Character devices are usually used to pass information to and from a user or another computer; some are input devices, some are output devices, and some are input/output devices. The keyboard, screen, printer and communications port are character devices.

Current versions of ProDOS 16 do not support character devices; that is, you cannot access character devices through ProDOS 16 calls. Consult the appropriate firmware or tools documentation, such as *Apple IIGS Firmware Reference* or *Apple IIGS Toolbox Reference*, for instructions on how to make calls to the particular device you wish to use.

---

---

## Accessing devices

Under ProDOS 16, you can access block devices through their device numbers, device names, or the volume names of the volumes mounted on them.

---

## Named devices

ProDOS 16 permits block devices to have assigned names. This ability is a convenience for users, because they will no longer have to know the volume name to access a disk.

However, ProDOS 16's support for named devices is limited. Device names may be used only in the VOLUME, GET\_DEV\_NUM, and FORMAT calls. Other calls that access devices require either a volume name or the device number returned by the GET\_DEV\_NUM or GET\_LAST\_DEV call.

Devices are named according to a built-in convention; assigned names may not be changed. The naming convention is as follows:

Device	Name
Any block device	.Dn
where	n= a 1-digit or 2-digit decimal number (assigned consecutively)

---

## Last device accessed

An application may ask ProDOS 16 for the identity of the last block device accessed. The *last device accessed* is defined here as the device to which the most recent call involving a disk read or write (including a block read or write) was directed.

When an application makes the GET\_LAST\_DEV call, ProDOS 16 returns the device number of the last block device accessed. The application can then use that information as input to subsequent device calls.

---

## Block read and block write

ProDOS 16 provides two device-access calls analogous to the file-access calls READ and WRITE. These calls, READ\_BLOCK and WRITE\_BLOCK, allow you to transfer information to and from a volume on a block device regardless of what files the volume contains.

The device number of a device (returned by `GET_DEV_NUM`) is a required input for the block read and write calls. The block read and write calls are powerful, but are not needed by most applications—the filing calls described in Chapter 2 are sufficient for normal disk I/O.

---

## Formatting a disk

Your application can format (initialize) a disk in a device through the ProDOS 16 `FORMAT` call. The call requires both a device name and a volume name as input. The disk in the specified device is formatted and given the specified volume name.

The other required input to the `FORMAT` call is the file system ID. It specifies the class of operating system for which the disk is to be formatted (such as DOS, ProDOS, or Pascal). Under current versions of ProDOS 16, however, the `FORMAT` call can format disks for the ProDOS/SOS file system only (file system ID = 1).

---

---

## Number of online devices

ProDOS 16 supports up to 14 active devices at a time. The Apple IIGS normally accepts up to 4 devices connected to its disk port (Smartport) and two devices per expansion slot (slots 1 through 7). It is possible, however, to have up to 4 devices on (a Smartport card in) slot 5. Nevertheless, the total number of devices on line still cannot exceed 14.

---

## Device search at startup

When ProDOS 16 boots, it performs a device search to identify all built-in pseudo-slot ROMs (internal ROMs) and all real physical slot ROMs (card ROMs). Every block device found is incorporated into ProDOS 16's list of devices, and assigned a device number (*dev\_num*) and device name (*dev\_name*).

- ❖ *Note:* Control Panel settings determine whether internal ROM or card ROM is active for each slot. ProDOS 16 cannot simultaneously support both internal and external devices with the same slot number.

In general, the device search proceeds from highest-numbered slots downward. For example, a disk drive in slot 7 drive 1 will be device number 1; another drive in slot 7 drive 2 will then be device 2, and on downward through all the slots.

SmartPort (slot 5's internal ROM and diskport) is a special case. Up to 4 devices may be connected to SmartPort. However, because ProDOS 16 supports only 2 devices per slot, the third and fourth devices are treated as if they were in slot 2. Despite the mapping of devices 3 and 4 into slot 2, however, all devices connected to SmartPort are given consecutive numbers. Table 4-1 shows the relationships.

**Table 4-1**  
SmartPort number, slot number, and device number assignments

SmartPort no.†	slot and drive	device number
1	slot 5 drive 1	<i>n</i>
2	slot 5 drive 2	<i>n</i> +1
3	slot 2 drive 1	<i>n</i> +2
4	slot 2 drive 2	<i>n</i> +3

† SmartPort device number 1 is connected directly to SmartPort. Subsequent devices are connected in daisy-chain fashion to the preceding ones, so that device number 4 is the farthest from SmartPort.

Apple Disk II and other related 5.25-inch disk drives are another special case. Because of the relatively long time required to access a Disk II drive and to determine whether a disk is present in it, Disk II drives are given the highest device numbers on the system. That way they will be searched last in any scan of online devices.



---

## Volume control blocks

For each device with nonremovable media (such as a hard disk) found at boot time, a **volume control block** (VCB) is created in memory. The VCB keeps track of the characteristics of that online volume. For other devices (such as floppy disk drives) found at boot time, VCB's are created as files are opened on the volumes in those devices. A maximum of eight VCB's may exist at any one time; if you try to open a file on a device whose volume presently has no open files, and if there are already eight VCB entries, error \$55 (VCB table full) is returned. Thus, even though there may be up to 14 devices connected to your system, only eight (at most) can be active (have open files) at any one moment.

---

---

## Interrupt handling

On the Apple IIGS, interrupts may be handled at either the firmware or the software level. The built-in interrupt handlers are in firmware (see *Apple IIGS Firmware Reference*); user-installed interrupt handlers are software and may be installed through ProDOS 16.

When the Apple IIGS detects an interrupt that is to be handled through ProDOS 16, it dispatches execution through the interrupt vector at \$00 03FE (page 3 in bank zero). At this point the microprocessor is running in emulation mode, using the standard clock speed and 8-bit registers. The vector at \$00 03FE has only two address bytes; in order to allow access to all of Apple IIGS memory, it points to another bank zero location. The vector in that location then passes control to the ProDOS 16 interrupt dispatcher. The interrupt dispatcher switches the processor to full native mode (including higher clock speed) and then polls the user-installed interrupt handlers.

Figure 4-1 is a simplified picture of what happens when a device generates an interrupt that is handled through a ProDOS 16 interrupt handler.



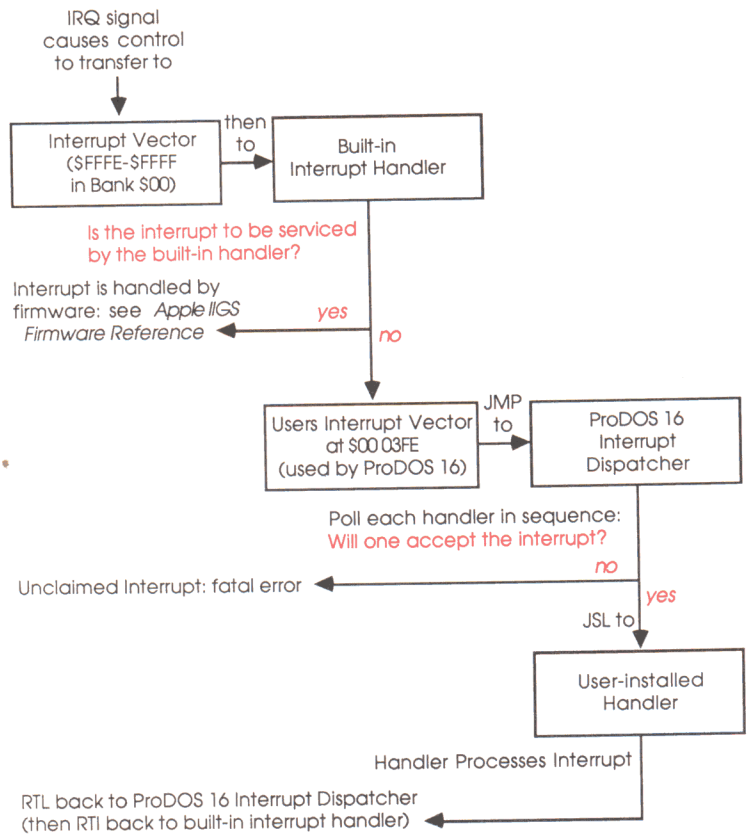

**Figure 4-1**  
Interrupt handling through ProDOS 16

ProDOS 16 supports up to 16 user-installed interrupt handlers. When an interrupt occurs that is not handled by firmware, ProDOS 16 transfers control to each handler successively until one of them claims it. There is no grouping of interrupts into classes; their priority rankings are reflected only by the order in which they are polled.

If you write an interrupt-handling routine, to make it active you must install it with the `ALLOC_INTERRUPT` call; to remove it, you must use the `DEALLOC_INTERRUPT` call. Be sure to enable the hardware generating the interrupt only *after* the routine to handle it is allocated; likewise, disable the hardware *before* the routine is deallocated. See Chapter 7 for further details on writing and installing interrupt handlers.

---

## Unclaimed interrupts

An *unclaimed interrupt* is defined as the condition in which the hardware Interrupt Request Line (IRQ) is active (being pulled low), indicating that an interrupt-producing device needs attention, but none of the installed interrupt handlers claims responsibility for the interrupt. When an interrupt occurs and ProDOS 16 can find no handler to claim it, it assumes that a serious hardware error has occurred. It issues a fatal error message to the System Failure Manager (see *Apple IIGS Toolbox Reference*), and stops processing the current application. Processing cannot resume until the user reboots the system



## Chapter 5



# ProDOS 16 and the Operating Environment

ProDOS 16 is one of the many components that make up the Apple IIGS **operating environment**, the overall hardware and software setting within which Apple IIGS application programs run. This chapter describes how ProDOS 16 functions in that environment and how it relates to the other components.

---

---

## Apple IIGS system disks

An Apple IIGS **system disk** is a disk containing the system software needed to run any application you wish to execute. Most system disks contain one or both operating systems (ProDOS 16 and ProDOS 8), the System Loader, RAM-based tool sets, RAM patches to ROM-based tool sets, fonts, desk accessories, boot-time initialization programs, and possibly one or more applications.

There are two basic types of system disks: *complete* system disks and *application* system disks. A complete system disk has a full set of Apple IIGS system software, as listed in table 5-1. It is a resource pool from which application system disks can be constructed. An application system disk has one or more application programs and only the specific system software it needs to run the application(s). For example, a word processor system disk may include a large selection of fonts, whereas a spreadsheet system disk may have only a few fonts.

Software developers may create application system disks for their programs. Users may also create application system disks, perhaps by combining several individual application disks into a multi-application system disk. Apart from the essential files listed in table 5-2, there is no single set of required contents for application system disks.

---

### Complete system disk

Every Apple IIGS user (and developer) needs at least one complete system disk. It is a pool of system software resources, and may contain files missing from any of the available application system disks. Table 5-1 lists the contents of a complete system disk.

**Table 5-1**  
Contents of a complete Apple IIgs system disk

Directory/File	Description
PRODOS	a routine that loads the proper operating system and selects an application, both at boot time and whenever an application quits
SYSTEM/	a subdirectory containing the following files:
P8	ProDOS 8 operating system
P16	ProDOS 16 operating system and Apple IIGS System Loader
START	typically a program selector
LIBS/	a subdirectory containing the standard system libraries
TOOLS/	a subdirectory containing all RAM-based tools
FONTS/	a subdirectory containing all fonts
DESK.ACCS/	a subdirectory containing all desk accessories
SYSTEM.SETUP/	a subdirectory containing system initialization programs
TOOL.SETUP	a load file containing patches to ROM and a program to install them. This is the only <i>required</i> file in the SYSTEM.SETUP/ subdirectory; it is executed before any others that may be in the subdirectory.
BASIC.SYSTEM	The Applesoft BASIC system interface program

The complete system disk is an 800K byte, double-sided 3.5-inch diskette; the required files will not fit on a 140K, single-sided 5.25-inch diskette.

When you boot a complete system disk, it executes the file SYSTEM/START. From the START file, you may choose to call Applesoft BASIC, the only application program available on the disk.

---

### The SYSTEM.SETUP/ subdirectory

The SYSTEM.SETUP/ subdirectory may contain several different types of files, all of which need to be loaded and initialized at boot time. They include the following:

- **The file TOOL.SETUP:** This file must always be present; it is executed before any others in SYSTEM.SETUP/: TOOL.SETUP installs and initializes any RAM patches to ROM-based tool sets. After TOOL.SETUP is finished, ProDOS 16 loads and executes the remaining files in the SYSTEM.SETUP/ subdirectory, which may belong to any of the categories listed below.



- **Permanent initialization files (filetype \$B6):** These files are loaded and executed just like standard applications (type \$B3), but they are not shut down when finished. They also must have certain characteristics:
  1. They must be loaded in non-special memory.
  2. They cannot permanently allocate any stack/direct-page space.
  3. They must terminate with an RTL (Return from subroutine Long) rather than a QUIT.
- **Temporary initialization files (type \$B7):** These files are loaded and executed just like standard applications (type \$B3), and they are shut down when finished. They must terminate with an RTL rather than a QUIT.
- **New desk accessories (type \$B8):** These files are loaded but not executed. They must be in non-special memory.
- **Classic desk accessories (type \$B9):** These files are loaded but not executed. They must be in non-special memory.

---

## Application system disks

Each application program or group of related programs comes on its own application system disk. The disk has all of the system files needed to run that application, but it may not have all the files present on a complete system disk. Different applications may have different system files on their application system disks.

For example, the *ProDOS 16 Exerciser* disk, included with this manual, is an application system disk. It contains all the system files listed above, plus the file EXERCISER (the exerciser itself).

Table 5-2 shows which files must be present on all application system disks, and which files are needed only for particular applications. In some very restricted instances, it may be possible to fit an application and its required system files onto a 5.25-inch (140K) diskette; most applications, however, require an 800K diskette.

**Table 5-2**

Required contents of an Apple IIgs application system disk

Directory/File	Required/(Required If...)
<b>PRODOS</b>	<b>required</b>
<b>SYSTEM/</b>	<b>required</b>
P8	(required if the application is ProDOS 8-based)
P16	<b>required</b>
START	(required if the program selector is to be used)
LIBS/	(required if system library routines are needed)
TOOLS/	(required if the application needs RAM-based tools)
FONTS/	(required if the application needs fonts)
DESK.ACCS/	(required if desk accessories are to be provided)
<b>SYSTEM.SETUP/</b>	<b>required</b>
<b>TOOL.SETUP</b>	<b>required</b>
BASIC.SYSTEM	(required if the application is written in Applesoft BASIC)

---

**Important** The files PRODOS, P8 and P16 all have version numbers. Whenever it loads an operating system (at startup or when launching an application), PRODOS checks the P8 or P16 version number against its own. If they do not match, it is a fatal error. Be careful not to construct an application system disk using incompatible versions of PRODOS, P8 and P16.

---



---



---

## System startup

Disk blocks 0 and 1 on an Apple IIGS system disk contain the startup (boot) code. They are identical to the boot blocks on standard Apple II system disks (ProDOS 8 system disks). This allows ProDOS 8 system disks to boot on an Apple IIGS, and it also means that the initial part of the ProDOS 16 bootstrap procedure is identical to that for ProDOS 8.

---

## Boot initialization

Figure 5-1 shows the boot initialization procedure. First, the boot firmware in ROM reads the boot code (blocks 0 and 1) into memory and executes it. For a system disk with a volume name /V,

1. The boot code searches the disk's volume directory for the first file named /V/PRODOS with the file type \$FF.
2. If the file is found, it is loaded and executed at location \$2000 of bank \$00.

From this point on, an Apple IIGS system disk behaves differently from a standard Apple II system disk. On a standard Apple II system disk, the file named PRODOS is the ProDOS 8 operating system. On an Apple IIGS system disk, however, this PRODOS file is not the operating system itself; it is an operating system loader and application selector. When it receives control from the boot code, /V/PRODOS performs the following tasks (see also Figure 5-1):

3. It relocates the part of itself named PQUIT to an area in memory where PQUIT will reside permanently. PQUIT contains the code required to terminate one program and start another (either ProDOS 8 or ProDOS 16 application).
4. /V/PRODOS loads the ProDOS 16 operating system and Apple IIGS System Loader (file /V/SYSTEM/P16).
5. /V/PRODOS performs any necessary boot initialization of the system, by executing the files in the subdirectory /V/SYSTEM/SYSTEM.SETUP/. If there is a file named TOOL.SETUP in that subdirectory, it is executed first—it loads RAM-based tools and RAM patches to ROM-based tools.

Every file in the subdirectory /V/SYSTEM/SYSTEM.SETUP/ must be an Apple IIGS load file of type \$B6, \$B7, \$B8, or \$B9. These file types are described under "The SYSTEM.SETUP/ Subdirectory," earlier in this chapter. After executing TOOL.SETUP, /V/PRODOS loads and executes, in turn, every other file that it finds in the subdirectory.

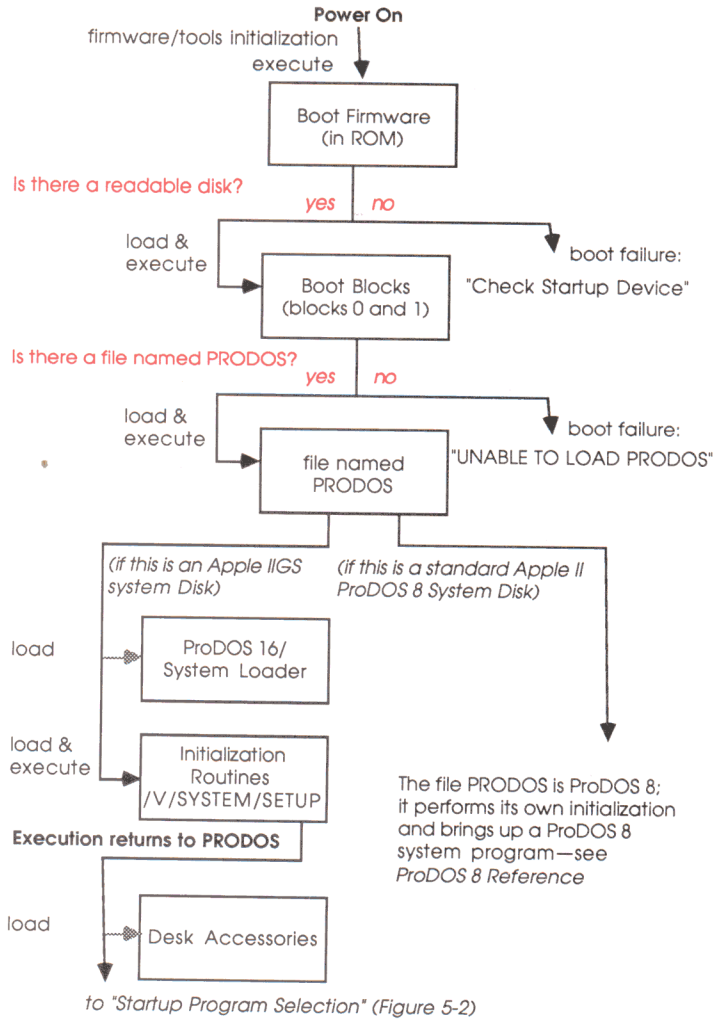

**Figure 5-1**  
Boot initialization sequence

---

## Startup program selection

6. Now /V/PRODOS selects (determines the pathname of) the system program or application to run. Figure 5-2 shows this procedure.
  - a. It first searches for a type \$B3 file named /V/SYSTEM/START. Typically, that file is a program selector, but it could be any Apple IIGS application. If START is found, it is selected.
  - b. If there is no START file, /V/PRODOS searches the boot volume directory for a file that is either one of the following:
    - a ProDOS 8 system program (type \$FF) with the filename extension .SYSTEM
    - a ProDOS 16 application (type \$B3) with the filename extension .SYS16

Whichever is found first is selected.

- ❖ *Note:* If a ProDOS 8 system program is found first, but the ProDOS 8 operating system (file /V/SYSTEM/P8) is not on the system disk, /V/PRODOS will then search for and select the first ProDOS 16 application (ProDOS 16 is *always* on the system disk).
  - c. If /V/PRODOS cannot find a file to execute (for example, if there is no START file and there are no ProDOS 8 or ProDOS 16 applications), it will bring up an interactive routine that prompts the user for the filename of an application to load.
7. Finally, /V/PRODOS passes control to an entry point in PQUIT. It is PQUIT, not /V/PRODOS, that actually loads the selected program. The next section describes that procedure.
- ❖ *Note:* PRODOS will write an error message to the screen if you try to boot it on an Apple II computer other than an Apple IIGS. This is because ProDOS 8 on an Apple IIGS disk is in the file V/SYSTEM/P8, not in the file PRODOS.



from "Boot Initialization" (Figure 5-1)  
(the file named PRODOS is in control)

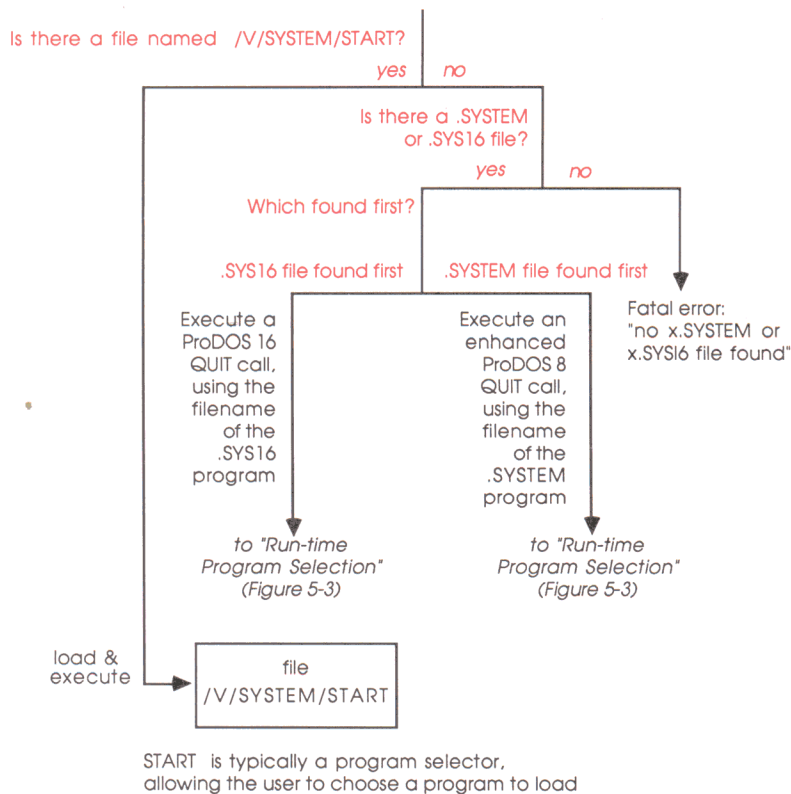

**Figure 5-2**  
Startup program selection

---

---

## Starting and quitting applications

The Apple IIGS startup sequence ends when control is passed to the program selection routine (PQUIT). This routine is entered both at boot time and whenever an application terminates with a ProDOS 16 or ProDOS 8 QUIT call.

---

## PQUIT

PQUIT is the ProDOS program dispatcher for the Apple IIGS. It determines which ProDOS 8 or ProDOS 16 program is to be run next, and runs it. After startup, PQUIT is permanently resident in memory; PQUIT loads ProDOS 16 programs through calls to the System Loader.

PQUIT has two entry points: P8PQUIT and P16PQUIT. Whenever a ProDOS 8 application executes a QUIT call, control passes through the P8PQUIT entry point. Whenever a ProDOS 16 application executes a QUIT call, control passes through the P16PQUIT entry point. To launch the first program at system startup, /V/PRODOS passes control to PQUIT as if executing a ProDOS 8 or ProDOS 16 QUIT call.

PQUIT supports three types of quit call: the standard ProDOS 8 QUIT call, an enhanced ProDOS 8 QUIT call, and the ProDOS 16 QUIT call.

### Standard ProDOS 8 QUIT call

The standard ProDOS 8 QUIT call's parameter block consists of a one-byte parameter count field (which must have the value \$04), followed by four null fields in this order: byte, word, byte, word. As ProDOS 8 is currently defined, all fields must be present and all must be set to zero. There is thus no way for a program to use the standard QUIT call to specify the pathname of the next program to run.

### Enhanced ProDOS 8 QUIT call

The enhanced ProDOS 8 QUIT call differs from the standard call only in the permissible values of the first two parameters (its parameter count field must still have the value \$04). In the enhanced QUIT call, the first (byte) parameter is defined as the *quit type*. If it is zero, the call is identical to a standard QUIT call; if it is \$EE, PQUIT interprets the following (word) parameter as a pointer to a string which is the pathname of the next program to run.

The enhanced ProDOS 8 QUIT call is meaningful only on the Apple II GS, and only when PQUIT is present to interpret it (that is, only when the computer has been booted with an Apple II GS system disk). It behaves like the standard ProDOS 8 QUIT call in any other situation.

- ❖ *Note:* Because of the way ProDOS uses memory, a ProDOS 8 application must not make an enhanced QUIT call (with a quit type of \$EE) from any location in page 2 of bank \$00 (addresses \$00 02 00 – \$00 02 FF).

### ProDOS 16 QUIT call

The ProDOS 16 QUIT call has two parameters: a pointer to the pathname of the next program to execute, and a pair of boolean flags: one (the *return flag*) notifies PQUIT whether or not control should eventually return to the program making the QUIT call; the other one (the *restart-from-memory flag*) lets the System Loader know whether the quitting program can be restarted from memory when it returns.

If the value of the return flag is true, PQUIT pushes the User ID of the calling (quitting) program onto an internal stack. As subsequent programs run and quit, several User ID's may be pushed onto the stack. With this mechanism, multiple levels of shells may execute subprograms and subshells, while ensuring that they eventually regain control when their subprograms quit.

For example, the program selector (START file) might pass control to a software development system shell, using the QUIT call to specify the shell and placing its own ID on the stack. The shell in turn could hand control to a debugger, likewise putting its own ID on the stack. If the debugger quits without specifying a pathname, control would pass automatically back to the shell; when the shell quit, control would pass automatically back to the START file.

This automatic return mechanism is specific to the ProDOS 16 QUIT call, and therefore is not available to ProDOS 8 programs. When a ProDOS 8 application quits, it cannot put its ID on the internal stack.

---

## QUIT procedure

This is a brief description of how PQUIT handles all three types of QUIT call. Refer also to Figure 5-3.

1. If a ProDOS 16 or enhanced ProDOS 8 QUIT call specifies a pathname, PQUIT attempts to execute the specified file. Under certain conditions this may not be possible: the file may not exist, there may be insufficient memory, and so on. In that case the QUIT call executes the interactive routine described below (step 3).
  - ❖ *Note:* PQUIT will load programs of file type \$B3, \$B5, or \$FF only.
2. If the QUIT call specifies no pathname, PQUIT pulls a User ID off its internal ID stack and attempts to execute that program. Typically, programs with User ID's on the stack are in the System Loader's **dormant** state (see "User Shutdown" in Chapter 17), and it may be possible to restart them without reloading them from disk. Under certain conditions it may not be possible to execute the program: the file may not exist, there may be insufficient memory, and so on. In that case the QUIT call executes the interactive routine described next (step 3).
3. If the QUIT call specifies no pathname and the ID stack is empty, PQUIT executes an interactive routine that allows the user to do any of these:
  - reboot the system
  - execute the file /V/SYSTEM/START
  - enter the pathname of a program to execute
4. If the quitting program is a ProDOS 16 program, PQUIT calls the loader's User Shutdown routine to place that program in a dormant state.
5. Once it has determined which program to load, PQUIT knows which operating system is required. If it is not the *current* system,
  - a. PQUIT shuts down the current operating system and loads the required one.
  - b. PQUIT then makes Memory Manager calls to free memory used by the former operating system and allocate memory needed by the new system. If the new operating system is ProDOS 8, PQUIT allocates all special memory for the program.

6. The new program is loaded. PQUIT calls the System Loader to load ProDOS 16 programs; for ProDOS 8 programs, PQUIT passes control to ProDOS 8, which then loads and executes its own program directly.
7. Finally (if it is a ProDOS 16 program), PQUIT sets up various aspects of the program's environment, including the direct-register and stack-pointer values, and passes control to the program.

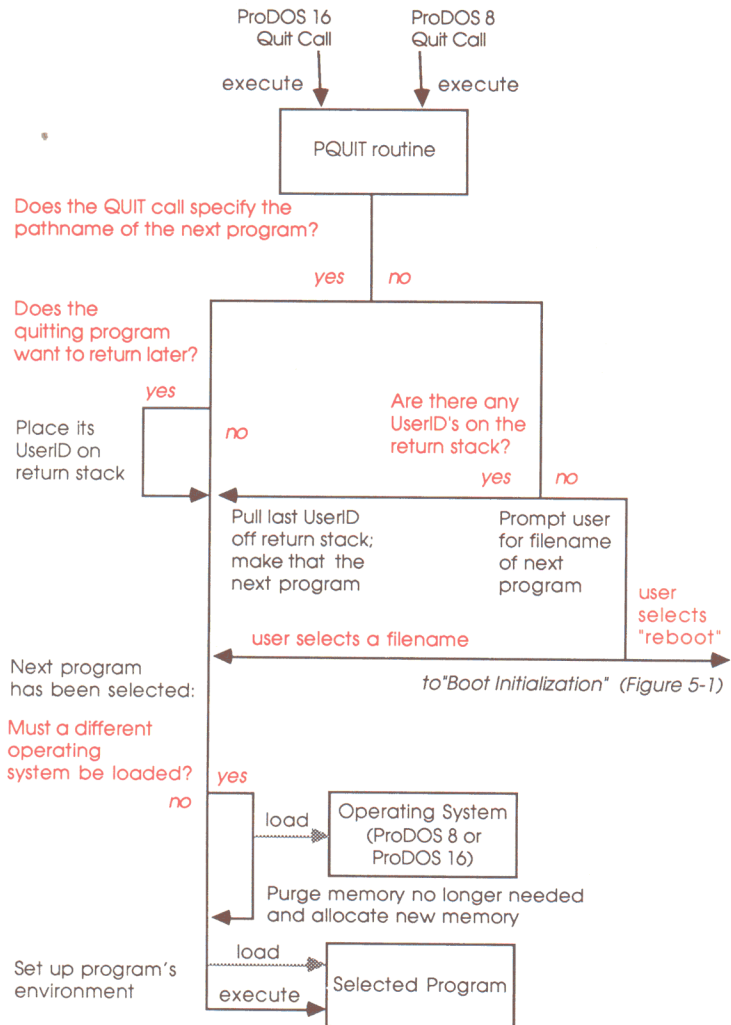

**Figure 5-3**  
Run-time program selection (QUIT call)



---

## Machine configuration at application launch

PQUIT initializes certain hardware and software components of the Apple IIGS before it passes control to a program. There are many other factors the machine's state that are not considered here, such as memory used by other software and the state of the dozens of soft switches and pseudoregisters available on the Apple IIGS. This section summarizes only the aspects of machine state that are explicitly set by ProDOS 16.

### ■ Reserved bank \$00 space:

Addresses above approximately \$9600 in bank zero are reserved for ProDOS 16, and therefore unavailable to the application. A direct-page/stack space, of a size determined either by ProDOS 16 or by the application itself, is reserved for the application (see Chapter 6); it is located in bank \$00 at an address determined by the Memory Manager. ProDOS 16 requires no other space in RAM (other than the language-card areas in banks \$00, \$01, \$E0, and \$E1—see Figure 3-2).

### ■ Hardware registers:

The accumulator contains the User ID assigned to the application.

The X- and Y-registers contain zero (\$0000).

The e-, m-, and x-flags in the processor status register are all set to zero, meaning that the processor is in *full native mode*.

The stack register contains the address of the top of the direct-page/stack space (see Chapter 6).

The direct register contains the address of the bottom of the direct-page/stack space (see Chapter 6).

### ■ Standard input/output:

For both \$B3 and \$B5 files, the standard input, output, and error locations are set to the Pascal 80-column character device vectors. See "Text Tool Set" in *Apple IIGS Toolbox Reference*.

### ■ Shadowing:

The value of the Shadow register is \$1E, which means:

language card and I/O spaces:	shadowing ON
text pages:	shadowing ON
graphics pages:	shadowing OFF

### ■ Vector space values:

Addresses between \$00A8 and \$00BF in bank \$E1 constitute ProDOS 16's *vector space*—so named because it contains the entry point (vector) to all ProDOS 16 calls. It also contains other information useful to system software such as AppleTalk®. The specific values an application finds in the vector space are listed in Table 3-2. These are the only fixed locations supported by ProDOS 16.

### ■ Pathname prefix values:

The nine available pathname prefixes are set as described in the next section.

---

---

## Pathname prefixes

A pathname **prefix** is a part of a pathname that starts with a volume name and ends with the name of a subdirectory. A preassigned prefix is convenient when many files in the same subdirectory are accessed, because it shortens the pathname references. A *set* of prefixes is convenient when files in several different subdirectories must be repeatedly accessed. The System Loader, for example, makes use of multiple prefixes. Once the pathname prefixes are assigned, an application can refer to the prefixes by code instead of keeping track of all the different pathnames.

ProDOS 16 supports 9 prefixes, referred to by the **prefix numbers** 0/, 1/, 2/,...,7/, and \*/. Each prefix number includes a terminating slash to separate it from the rest of the pathname. A prefix number at the beginning of a partial pathname replaces the actual prefix. One of the prefix numbers has a fixed value, and the others have default values assigned by ProDOS 16 (see Table 5-4). The most important predefined prefixes are

- \* / the boot prefix—it is the name of the volume from which the presently running ProDOS 16 was booted.
- 0 / the default prefix (automatically attached to any partial pathname that has no prefix number)—it has a value dependent on how the current program was launched. In some cases it is equal to the boot prefix.

- 1/ the application prefix—it is the pathname of the subdirectory that contains the currently running application.
- 2/ the system library prefix—it is the pathname of the subdirectory (on the boot volume) that contains the library files used by applications.

Your application may assign the rest of the prefixes. In fact, once your application is running, it may also change the values of prefixes 0/, 1/, or 2/ (applications may not change prefix \*/).

Prefix 0/ is similar to the ProDOS 8 *system prefix*, in that ProDOS 16 automatically attaches prefix 0/ to any partial pathname for which you specify no prefix. However, its initial value is not always equivalent to the ProDOS 8 system prefix's initial value. See *ProDOS 8 Technical Reference Manual*.

The prefix numbers are set (assigned to specific pathnames) and retrieved through the SET\_PREFIX and GET\_PREFIX calls. Although a prefix number may be used as an input to the SET\_PREFIX call, prefixes are always stored in memory as full pathnames (that is, they include no prefix numbers themselves).

Table 5-3 shows some examples of prefix use. They assume that prefix 0/ is set to /VOLUME1/ and that prefix 5/ is set to /VOLUME1/TEXT.FILES/. The pathname provided by the caller is compared with the full pathname constructed by ProDOS 16.

**Table 5-3**  
Examples of prefix use

	as supplied	as expanded by ProDos 16
Full pathname provided:	/VOLUME1/TEXT.FILES/CHAP.3	/VOLUME1/TEXT.FILES/CHAP.3
Partial pathname—implicit use of prefix /0:	PRODOS	/VOLUME1/PRODOS
Explicit use of prefix /0:	0/SYSTEM/FINDER	/VOLUME1/SYSTEM/FINDER
Use of prefix 5/:	5/CHAP.12	/VOLUME1/TEXT.FILES/CHAP.12

## Initial ProDOS 16 prefix values

When an application is launched, all nine prefix numbers are assigned to specific pathnames (some are meaningful pathnames, whereas others may be null strings). Remember, an application may change the assignment of any prefix number except the boot prefix (\* /). Furthermore, in some cases certain initial prefix values may be left over from the previous application. Therefore, beware of assuming a value for any particular prefix.

Table 5-4 shows the initial values of the prefix numbers that a ProDOS 16 application receives, under the three different launching conditions possible on the Apple IIGS. At all times during execution, GET\_NAME returns the filename of the current application (regardless of whether prefix 1 / has been changed), and GET\_BOOT\_VOL returns the boot volume name, equal to the value of prefix \* / (regardless of whether prefix 0 / has been changed).

**Table 5-4**  
Initial ProDOS 16 prefix values

	Prefix no.	Initial value
ProDOS 16 application launched at boot time:	0 /	boot volume name
	1 /	full pathname of the directory containing the current application
	2 /	full pathname of the application library directory ( <i>/boot volume name/SYSTEM/LIBS</i> )
	3 /	null string
	4 /	null string
	5 /	null string
	6 /	null string
	7 /	null string
	* /	boot volume name



**Table 5-4 (continued)**  
Initial ProDOS 16 prefix values

	Prefix no.	Initial value
ProDOS 16 application launched after a ProDOS 8 application has quit:	0/	unchanged from the ProDOS 8 <i>system prefix</i> under the previous application
	1/	full pathname of the directory containing the current application
	2/	full pathname of the application library directory ( <i>/boot volume name/SYSTEM/LIBS</i> )
	3/	null string
	4/	null string
	5/	null string
	6/	null string
ProDOS 16 application launched after a ProDOS 16 application has quit:	0/	unchanged from the previous application
	1/	full pathname of the directory containing the current application
	2/	unchanged from the previous application
	3/	unchanged from the previous application
	4/	unchanged from the previous application
	5/	unchanged from the previous application
	6/	unchanged from the previous application
7/	unchanged from the previous application	
	*/	unchanged from the previous application

### ProDOS 8 prefix and pathname convention

ProDOS 8 supports a single prefix, called the *system prefix* (or *current prefix*). It has no prefix number—it is attached automatically to any partial pathname (one that does not begin with a slash and a volume name). Like the ProDOS 16 prefixes, the ProDOS 8 system prefix may be changed by a SET\_PREFIX call. On a standard Apple II, the default value of the system prefix at startup is the boot volume name; however, system programs such as the Applesoft BASIC interpreter commonly reset the system prefix to other values.



An application that is running under ProDOS 8 can always find its own pathname by looking at location \$0280 (in bank \$00 on an Apple IIGS); ProDOS 8 stores the application's full or partial pathname there. For details of this and other ProDOS 8 pathname conventions, see *ProDOS 8 Technical Reference Manual*.

On the Apple IIGS, the PQUIT routine allows a ProDOS 8 application to be launched at boot time, or after another ProDOS 8 application has quit, or after a ProDOS 16 application has quit. The initial values of the system prefix and the pathname at location \$0280 are dependent on which way the application was launched. Table 5-5 lists the possibilities.

**Table 5-5**  
Initial ProDOS 8 prefix and pathname\* values

	system prefix	location \$0280 pathname
ProDOS 8 application launched at boot time:	boot volume name	filename of the just-launched application
ProDOS 8 application launched through an enhanced ProDOS 8 QUIT call:	unchanged from the previous (ProDOS 8) application	the full or partial pathname given in the enhanced ProDOS 8 QUIT call
ProDOS 8 application launched through a ProDOS 16 QUIT call: (If the ProDOS 16 QUIT call specified a <i>full</i> pathname)	the previous (ProDOS 16) application's prefix 0/	the full pathname given in the ProDOS 16 QUIT call
ProDOS 8 application launched through a ProDOS 16 QUIT call: (If the ProDOS 16 QUIT call specified a <i>partial</i> pathname)	the prefix specified in the ProDOS 16 QUIT call	the partial pathname (minus the prefix number) given in the ProDOS 16 QUIT call

❖ *Note:* Conditions (2) through (3b) in Table 5-4 apply only to ProDOS 8 applications launched from an Apple IIGS *booted on an Apple IIGS system disk*. If a ProDOS 8 application on a *standard Apple II system disk* is booted on an Apple IIGS, the Apple IIGS acts like a standard Apple II and condition (1) is the only possibility.

---

---

## Tools, firmware, and system software

Although ProDOS 16 is the principal part of the Apple IIGS operating system, several “operating system-like” functions are actually carried out by other software components. This section briefly describes some of those components; for detailed information see the references listed with each one.

---

### The Memory Manager

As explained in Chapter 3, the Memory Manager takes care of all memory allocation, deallocation, and housekeeping chores. Applications obtain needed memory space either directly, through requests to the Memory Manager, or indirectly through ProDOS 16 or System Loader calls (which in turn obtain the memory through requests to the Memory Manager).

The Memory Manager is a ROM-resident Apple IIGS tool set; for more detailed information on its functions and how to call them, see *Apple IIGS Toolbox Reference*.

---

### The System Loader

The System Loader is an Apple IIGS tool set that works very closely with ProDOS 16 and the Memory Manager. It resides on the system disk, along with ProDOS 16 and other system software (see “Apple IIGS System Disks” in this chapter). All programs and data are loaded into memory by the System Loader.

The System Loader supports both static and dynamic loading of segmented programs and subroutine libraries. It loads files that conform to a specific format (**object module format**); such files are produced by the **APW Linker** and other components of the **Apple IIGS Programmer’s Workshop** (see *Apple IIGS Programmer’s Workshop Reference*).

The System Loader is described in Part III of this manual.

---

## The Scheduler

The **Scheduler** is a tool set that functions in conjunction with the Apple IIGS Heartbeat Interrupt signal (see “Scheduler” in *Apple IIGS Toolbox Reference*). Its purpose is to coordinate the execution of interrupt handlers and other interrupt-based routines such as desk accessories.

The Scheduler is required only when an interrupt routine needs to call a piece of system software, such as ProDOS 16, that is not **reentrant**. If ProDOS 16 is in the middle of a call when an interrupt occurs, the interrupting routine cannot itself call ProDOS 16, because that would disrupt the first (not yet completed) call. The system needs a way of telling an interrupt routine to hold off until the system software it needs is no longer busy.

The Scheduler accomplishes this by periodically checking a word-length flag called the **Busy word** and maintaining a queue of processes that may be activated when the Busy word is cleared. Interrupt routines that make operating system calls must go through the Scheduler (see Chapter 7).

---

## The User ID Manager

The User ID Manager is a Miscellaneous tool set that provides a way for programs to obtain unique identification numbers. Every memory block allocated by the Memory Manager is marked with a User ID that shows what system software, application, or desk accessory it belongs to.

Part of each block's 2-byte User ID is a **TypeID** field, describing the category of load segment that occupies it. All ProDOS 8 and ProDOS 16 blocks are type 3; System Loader blocks are type 7; blocks of controlling programs (such as a shell or switcher) are type 2; and blocks containing application segments are type 1. Appendix D diagrams the format for the User ID word. See “Miscellaneous Tool Sets” in *Apple IIGS Toolbox Reference* for further details.

ProDOS 16 and the System Loader rely on User ID's to help them restart or reload applications. See “Quit Procedure” in this chapter, and “Restart” and “User Shutdown” in Chapter 17.

---

## The System Failure Manager

All fatal errors, including fatal ProDOS 16 errors, are routed through the System Failure Manager, a Miscellaneous Tool Set. It displays a default message on the screen, or, if passed a pointer when it is called, displays an ASCII string with a user-chosen message. Program execution halts when the System Failure Manager is called.

The System Failure Manager is described under "Miscellaneous Tool Sets" in *Apple IIGS Toolbox Reference*.



## Chapter 6



# Programming With ProDOS 16



This chapter presents requirements and suggestions for writing Apple IIGS programs that use ProDOS 16.

Programming suggestions for the System Loader are in Chapter 16 of this manual. More general information on how to program for the Apple IIGS is available in *Programmer's Introduction to the Apple IIGS*. For language-specific programming instructions, consult the appropriate language manual in the Apple IIGS Programmer's Workshop (see "Apple IIGS Programmer's Workshop" in this chapter).

---

---

## Application requirements

As used in this manual, an **application** is a complete program, typically called by a user, that can communicate directly with ProDOS 16 and any other system software or firmware it needs. For example, word processors, spreadsheet programs, and programming-language interpreters are examples of applications. Data files and source-code files, as well as subroutines, libraries, and utilities that must be called from other programs are not applications.

To be an application, an Apple IIGS program must

- consist of executable machine-language code
- be in Apple IIGS object module format (see Appendix D)
- be file type \$B3 (specialized applications may have other file types—see Appendix A)
- have a filename extension of .SYS16 (if you want it to be self-booting at system startup—see Chapter 5)
- make ProDOS 16 calls as described in this manual (see Chapter 8)
- observe the ProDOS 16 QUIT conventions (see Chapter 5)
- observe all other applicable ProDOS 16 conventions, such as the conventions for interrupt handlers (see Chapter 7)
- get all needed memory from the Memory Manager (see Chapter 3)

Most other aspects of the program are up to you. The rest of this chapter presents conventions and suggestions to help you create an efficient and useful application, consistent with Apple IIGS programming concepts and practices.

---

---

## Stack and direct page

In the Apple IIGS, the 65C816 microprocessor's stack-pointer register is 16 bits wide; that means that, in theory, the hardware stack may be located anywhere in bank \$00 of memory, and the stack may be as much as 64K bytes deep.

The **direct page** is the Apple IIGS equivalent to the standard Apple II **zero page**. The difference is that it need not be page zero in memory. Like the stack, the direct page may theoretically be placed in any unused area of bank \$00—the microprocessor's **direct register** is 16 bits wide, and all zero-page (direct-page) addresses are added as offsets to the contents of that register.

In practice, however, there are several restrictions on available space. First, only the lower 48K bytes of bank \$00 can be allocated—the rest is reserved for I/O space and system software. Also, because more than one program can be active at a time, there may be more than one stack and more than one direct page in bank \$00. Furthermore, many applications may want to have parts of their code as well as their stacks and direct pages in bank \$00.

Your program should therefore be as efficient as possible in its use of stack and direct-page space. The total size of both should probably not exceed about 4K bytes in most cases. Still, that gives you the opportunity to write programs that require stacks and direct pages much larger than the 256 bytes available for each on standard Apple II computers.

---

## Automatic allocation of stack and direct page

Only you can decide how much stack and direct-page space your program will need when it is running. The best time to make that decision is during program development, when you create your source file(s). If you specify at that time the total amount of space needed, ProDOS 16 and the System Loader will automatically allocate it and set the stack and direct registers each time your program runs.

## Definition during program development

You define your program's stack and direct-page needs by specifying a "direct-page/stack" object segment (KIND = \$12; see Appendix D) when you assemble or compile your program (Figure 6-1). The size of the segment is the total amount of stack and direct-page space your program needs. It is not *necessary* to create this segment; if you need no such space or if the ProDOS 16 default is sufficient (see "ProDOS 16 default stack and direct page" later in this section), you may leave it out.

When the program is linked, it is important that the direct-page/stack segment not be combined with any other object segments to make a load segment—the linker must create a single load segment corresponding to the direct-page/stack object segment. If there is no direct-page/stack object segment, the linker will not create a corresponding load segment.

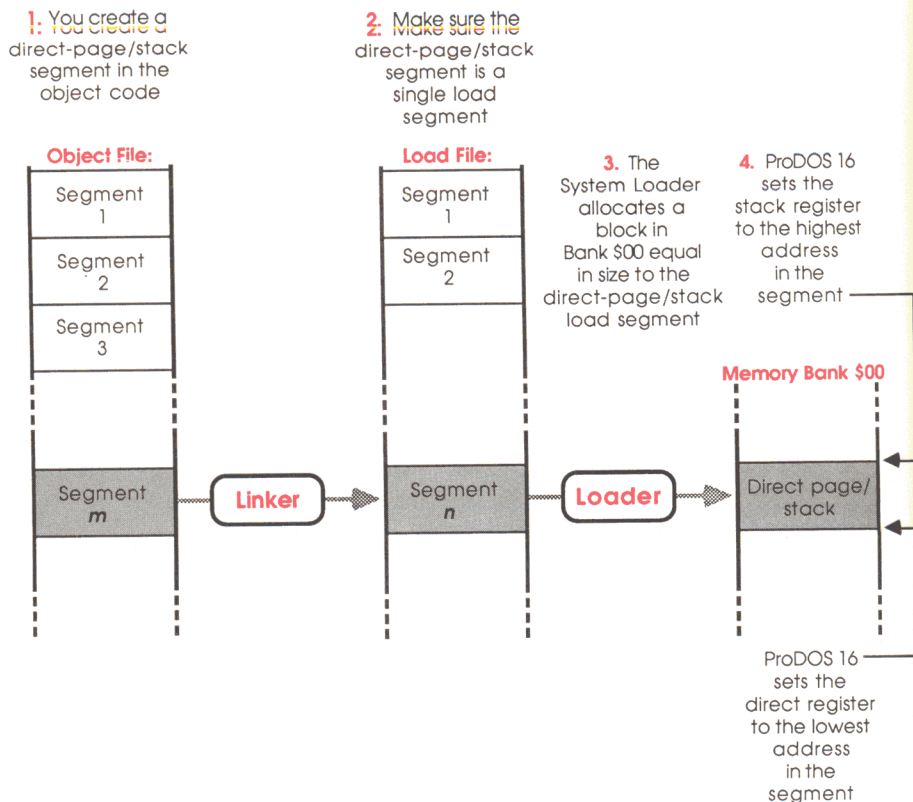

**Figure 6-1**  
Automatic direct-page/stack allocation

## Allocation at run time

Each time the program is started, the System Loader looks for a direct-page/stack load segment. If it finds one, the loader calls the Memory Manager to allocate a page-aligned, locked memory block of that size in bank \$00. The loader loads the segment and passes its base address and size, along with the program's User ID and starting address, to ProDOS 16. ProDOS 16 sets the A (accumulator), D (direct), and S (stack) registers as shown, then passes control to the program:

A = User ID assigned to the program

D = address of the first (lowest-address) byte in the direct-page/stack space

S = address of the last (highest-address) byte in the direct-page/stack space

By this convention, direct-page addresses are offsets from the base of the allocated space, and the stack grows downward from the top of the space.

---

**Important** ProDOS 16 provides no mechanism for detecting stack overflow or underflow, or collision of the stack with the direct page. Your program must be carefully designed and tested to make sure this cannot occur.

---

When your program terminates with a QUIT call, the System Loader's Application Shutdown function makes the direct-page/stack segment purgeable, along with the program's other static segments. As long as that segment is not subsequently purged, its contents are preserved until the program restarts. See "Application Shutdown" and "Restart" in Chapter 17.

❖ *Note:* There is no provision for extending or moving the direct-page/stack space after its initial allocation. Because bank \$00 is so heavily used, any additional space you later request may be unavailable—the memory adjoining your stack is likely to be occupied by a locked memory block. Make sure that the amount of space you specify at link time fills all your program's needs.



## ProDOS 16 default stack and direct page

If the loader finds no direct-page/stack segment in a file at load time, it still returns the program's User ID and starting address to ProDOS 16, but it does not call the Memory Manager to allocate a direct-page/stack space and it returns zeros as the base address and size of the space. ProDOS 16 then calls the Memory Manager itself, and allocates a 1K direct-page/stack segment with the following attributes:

size:	1,024 bytes
owner:	program with the User ID returned by the loader
fixed/movable:	fixed
locked/unlocked:	locked
purge level:	1
may cross bank boundary?	no
may use special memory?	yes
alignment:	page-aligned
absolute starting address?	no
fixed bank?	yes—bank \$00

See *Apple II GS Toolbox Reference* for a general description of memory block attributes assigned by the Memory Manager.

Once allocated, the default direct-page/stack is treated just as it would be if it had been specified by the program: ProDOS 16 sets the A, D, and S registers before handing control to the program, and at shutdown time the System Loader purges the segment.

---

## Manual allocation of stack and direct page

Your program may allocate its own stack and direct-page space at run time, if you prefer. When ProDOS 16 transfers control to your program, be sure the program saves the User ID value left in the accumulator before doing the following:



1. Using the starting or ending address left in the D or S register by ProDOS 16, it should make a `FindHandle` call to the Memory Manager, to get the memory handle of the automatically-provided direct-page/stack space. Then, using that handle, it should get rid of the space with a `DisposeHandle` call.
2. It can now allocate its own direct-page/stack space through the Memory Manager `NewHandle` call. The allocated block must be *purgeable*, *fixed*, and *locked*.
3. Finally, the program must place the appropriate values (beginning and end addresses of the segment) in the D and S registers.

---

---

## Managing system resources

Various hardware and software features of the Apple IIGS can provide an application with useful information, or can otherwise increase its flexibility. This section suggests ways to use those features.

---

### Global variables

Under ProDOS 8, a fixed-address **global page** maintains the values of important variables and addresses for use by applications. The global page is at the same address in any machine or machine configuration that supports ProDOS 8, so an application can always access those variables at the same addresses.

ProDOS 16 does not provide a global page. Such a set of fixed locations is inconsistent with the flexible and dynamic memory management system of the Apple IIGS. Instead, calls to ProDOS 16, tools, or firmware give you the information formerly provided by the global page. Table 6-1 shows the Apple IIGS calls used to obtain information equivalent to ProDOS 8 global page values.

**Table 6-1**

Apple IIGs equivalents to ProDOS 8 global page information

Global page Information	Apple IIGs Equivalent
Global page entry points	(not supported)
Device driver vectors	(not supported)
List of active devices	returned by VOLUME call (ProDOS 16)
Memory Map	(responsibility of the Memory Manager)
Pointers to I/O buffers	returned by OPEN call (ProDOS 16)
Interrupt vectors	returned by ALLOC_INTERRUPT call (ProDOS 16)
Date/Time	returned by ReadTime call (Misc. tool set)
System Level	returned by GET_LEVEL call (ProDOS 16)
MACHID	(not supported)
Application version	(not supported)
ProDOS 16 Version	returned by GET_VERSION call (ProDOS 16)

Of course, the Apple IIGs always supports the ProDOS 8 global page *when a ProDOS 8 application is running.*

---

## Prefixes

The nine available prefixes described in Chapter 5 offer convenience in coding pathnames and flexibility in writing for different system and application disk volumes. For example, any files on the boot disk can always be accessed through the prefix \*/, regardless of the volume name of that particular boot disk. Any library routine in the system library subdirectory will have the prefix 2/, regardless of which system disk is on line (unless your program has changed the value of the prefix). If you put routines specific to your application in the same subdirectory as your application, they can always be called with the prefix 1/, regardless of what subdirectory or disk your program inhabits.

Your application can always change the values of any of the prefixes except \*/. For example, it may change prefix 2/ if it wishes to access libraries (or any other files) on a volume other than the boot volume. But be careful: once you change prefix 1/, for example, you can no longer use it as the application prefix. Be sure to save the value of a prefix number before you change it, if you may want to recover it later.

---

## Native mode and emulation mode

You can make ProDOS 16 calls when the processor is in either emulation mode or native mode. So if part of your program requires the processor to be in emulation mode, you needn't reset it to native mode before calling ProDOS 16. However, emulation-mode calls to ProDOS 16 must be made *from bank \$00*, and they can reference information (such as parameter blocks) in bank \$00 only. Furthermore, interrupts must be *disabled*.

ProDOS 8 programs run entirely in emulation mode. If you wish to modify a ProDOS 8 program to run under ProDOS 16, or if you wish to use Apple IIGS features available only in native mode, see "Revising a ProDOS 8 Application for ProDOS 16" in this chapter. See also *Programmer's Introduction to the Apple IIGS*.

---

## Setting initial machine configuration

When an Apple IIGS application (type \$B3) is first launched, the Apple IIGS is in full native mode with graphics shadowing off (see "Machine Configuration at Application Launch" in Chapter 5). If your program needs a different machine configuration, it must make the proper settings once it gains control.

ProDOS 16 does not initialize soft switches, firmware registers, or any hardware registers other than those listed in Chapter 5. Your program is responsible for initializing any needed switches and registers.

---

## Allocating memory

All memory allocation is done through calls to the Memory Manager, described in *Apple IIGS Toolbox Reference*. Memory space you request may be either movable or unmovable (fixed). If it is movable, you access it through a memory handle; if it is unmovable, you may access it through a handle or through a pointer. Since the Memory Manager does not return a pointer to an allocated block, you obtain the pointer by dereferencing the handle (see Chapter 3).

- ProDOS 16 parameter blocks are referenced by pointers; if you do not code them into your program segments and reference them with labels, you must put them in unmovable memory blocks. See
- “Setting up a Parameter Block in Memory” in Chapter 8.

---

## Loading another program

If you do not want your program to load another program when it finishes, it should use a ProDOS 16 QUIT call with all parameters set to 0. The QUIT routine performs all necessary functions to shut down the current application, and normally brings up a program selector which allows the user to choose the next program to load. Most applications function this way.

However, if you want your application to load and execute another application, there are several ways to do it. If you wish to pass control *permanently* to another application, use the ProDOS 16 QUIT call with only a pathname pointer, as described in Chapter 5. If you wish control to *return* to your application once the next application is finished, use also the return flag parameter in the QUIT call. That way your program can function similarly to a shell—whenever it quits to another specified program, it knows that it will eventually be re-executed.

If you wish to load but not necessarily pass control to another program, or if you want your program to remain in memory after it passes control to another program, use the System Loader's Initial Load function (described in Chapter 17). When your program actively loads other program files, it is called a **controlling program**; the APW Shell (see “Apple IIGS Programmer's Workshop” in this chapter) is a controlling program. Chapter 16 gives suggestions for writing controlling programs.



You can load a ProDOS 8 application (type \$FF) through the ProDOS 16 QUIT call, but you cannot do so with the System Loader's Initial Load call; the System Loader will load only ProDOS 16 load files (types \$B3-\$BE).

- ❖ *Note:* Because ProDOS 8 will not load type \$B3 files, ProDOS 8-based applications that load and run other applications cannot run any ProDOS 16 applications. This restriction is a natural consequence of the lack of downward compatibility. If you wish to modify an older application to be able to use it with ProDOS 16, see “Revising a ProDOS 8 Application for ProDOS 16,” later in this chapter.

---

## Using interrupts

ProDOS 16 provides conventions (see Chapter 7) to ensure that interrupt-handling routines will function correctly. If you are writing a print spooler, game, communications program or other routine that uses interrupts, please follow those conventions.

As explained in Chapter 4, an *unclaimed interrupt* causes a system failure: control is passed to the System Failure Manager and execution halts. Your program may pass a message to the System Failure Manager to display on the screen when that happens. In addition, because the System Failure Manager is a tool, and because all tools may be replaced by user-written routines, you may substitute your own error handler for unclaimed interrupts. See *Apple IIGS Toolbox Reference* for information on the System Failure Manager and for instructions on writing your own tool set.

If ProDOS 16 is called while it is in the midst of another call, it issues a “ProDOS is busy” error. This situation normally arises only when an interrupt handler makes ProDOS 16 calls; a typical application will always find ProDOS 16 free to accept a call. Chapter 7 provides instructions on how to avoid this error when writing interrupt handlers; nevertheless, *all programs* should be able to handle the “ProDOS is busy” error code in case it occurs.



---

## Accessing devices

Under ProDOS 8, block devices on Apple II computers are specified by a *unit number*, related to slot and drive number (such as slot 5, drive 1). ProDOS 16 does not directly support that numbering system; instead, it identifies devices by *device number* and *device name*. As explained in Chapter 4, device numbers are assigned in order of the device search at system startup, and device names are assigned according to a simple ProDOS 16 convention. You must use device numbers or names in ProDOS 16 device calls.

For filing calls and for one device call (`GET_DEV_NUM`), you may also access a device through the name of the volume on the device. In addition, you may use the `GET_LAST_DEV` call to identify the last device accessed, in case you wish to access it again.

---

---

## File creation/modification date and time

The information in this section is important to you if you are writing a file or disk utility program, or any routine that copies files.

All ProDOS 16 files are marked with the date and time of their creation. When a file is first created, ProDOS 16 stamps the file's directory entry with the current date and time from the system clock. If the file is later modified, ProDOS 16 then stamps it with a modification date and time (its creation date and time remain unchanged).

The creation and modification fields in a file entry refer to the *contents* of the file. The values in these fields should be changed only if the contents of the file change. Since data in the file's directory entry itself are not part of the file's contents, the modification field should not be updated when another field in the file entry is changed, *unless* that change is due to an alteration in the file's contents. For example, a change in the file's name is not a modification; on the other hand, a change in the file's EOF always reflects a change in its contents and therefore is a modification.

Remember also that a file's entry is a part of the contents of the directory or subdirectory that contains that *entry*. Thus, whenever a file entry is changed in any way (whether or not its modification field is changed), the modification fields in the entries for all its enclosing subdirectories—including the volume directory—must be updated.

Finally, when a file is *copied*, a utility program must be sure to give the copy the same creation and modification date and time as the original file, and *not* the date and time at which the copy was created.

To implement these concepts, file utility programs should note the following procedures:

**1. To create a new file:**

- a. Set the creation and modification fields of the file's entry to the current system date and time.
- b. Set the modification fields in the entries of all subdirectories in the path containing the file to the current system date and time.

**2. To rename a file:**

- a. Do not change the file's modification field.
- b. Set the modification fields of all subdirectories in the path containing the file to the current system date and time.

**3. To alter the contents of a file:**

- a. ProDOS 16 considers a file's contents to have been modified if any `WRITE` or `SET_EOF` operation has been performed on the file while it is open. If that condition has been met, set the file's modification field to the current system date and time when the file is closed.
- b. Also set the modification fields of all subdirectories in the path containing the file to the current system date and time.

**4. To delete a file:**

- a. Delete the file's entry from the directory or subdirectory that contains it.
- b. Set the modification fields of all subdirectories in the path containing the deleted file to the current system date and time.

**5. To copy a file:**

- a. Make a `GET_FILE_INFO` call on the source file (the file to be copied), to get its creation and modification dates and times.
- b. Make a `CREATE` call to create the destination file (the file to be copied to). Give it the creation date and time values obtained in step (a).
- c. Open both the source and destination files. Use `READS` and `WRITES` to copy the source to the destination. Close both files.

❖ *Note:* The procedure for copying sparse files is more complicated than this. See Chapter 2 and Appendix A.

- d. Make a `SET_FILE_INFO` call on the destination file, using all the information returned from `GET_FILE_INFO` in step (a). This sets the modification date and time values to those of the source file.

ProDOS 16 automatically carries out all steps in procedures (1) through (4). Procedure (5) is the responsibility of the file-copying utility.

---

---

## Revising a ProDOS 8 application for ProDOS 16

If you have written a ProDOS 8-based program for a standard Apple II (64K Apple II Plus, Apple IIe, or Apple IIc), it will run without modification on the Apple IIGS. The only noticeable difference will be its faster execution because of the greater clock speed of the Apple IIGS. However, the program will not be able to take advantage of any advanced Apple IIGS features such as large memory, the toolbox, the mouse-based interface, and new graphics and sound abilities. This section discusses some of the basic alterations necessary to upgrade a ProDOS 8 application for native-mode execution under ProDOS 16 on the Apple IIGS.

Because ProDOS 16 closely parallels ProDOS 8 in function names and calling structure, it is not difficult to change system calls from one ProDOS to the other. But several other aspects of your program also must be redesigned if it is to run in native mode under ProDOS 16. Depending on the program's size and structure and the new features you wish to install, those changes may range from minor to drastic.

---

### Memory management

Because the Apple IIGS supports segmented load files, one of the first decisions to make is whether and how to segment the program (both the original program and any added parts), and where in memory to put the segments.

To help decide where in memory to place pieces of your program, consider that execution speed is related to memory location: banks \$E0 and \$E1 execute at standard clock speed, and all the other banks execute at fast clock speed (see *Apple IIGS Hardware Reference*). Those parts of your program that are executed most often should probably go into fast memory, while less-used parts and data segments may be appropriate in standard-speed memory. On the other hand, because all I/O goes through banks \$E0 or \$E1, program segments that make heavy use of I/O instructions might work best in standard-speed memory. Performance testing of the completed program is the only way to accurately determine where segments should go.

Memory management methods are completely different under ProDOS 16 than under ProDOS 8. If your ProDOS 8 program manages memory by allocating its own memory space and marking it off in the global page bit map, the ProDOS 16 version must be altered so that it requests all needed space from the Memory Manager. Whereas ProDOS 8 does not check to see if you are using only your marked-off space, the Memory Manager under ProDOS 16 will not assign to your program any part of memory that has already been allocated.

---

## Hardware configuration

ProDOS 8 applications run only in 6502 emulation mode on the Apple IIGS. That does not mean that applications converted to run under ProDOS 16 must necessarily run in native mode. There are at least three configurations possible:

- The program may run in emulation mode, but make ProDOS 16 calls.
- The program may run in native mode with the m- and x-bits set. The accumulator and index registers will remain 8 bits wide.
- The program may run in full native mode (m- and x-bits cleared).

Modifying a program for the first configuration probably involves the least effort, but returns the least benefit.

Modifying a program to run in full native mode is the most difficult, but it makes best use of all Apple IIGS features.



---

## Converting system calls

For most ProDOS 8 calls, there is an equivalent ProDOS 16 call with the same name. Each call block must be modified for ProDOS 16: the JSR (Jump to Subroutine) assembly-language instruction replaced with a JSL (Jump to Subroutine *Long*), the call number field made 2 bytes long, and the parameter list pointer made 4 bytes long. The only other conversion required is the reconstruction of the parameter block to the ProDOS 16 format.

For other ProDOS 8 calls, the ProDOS 16 equivalent performs a slightly different task, and the original code will have to be changed to account for that. For example, in ProDOS 8 an ON\_LINE call can be used directly to determine the names of all online volumes; in ProDOS 16 a succession of VOLUME calls is required. Refer to the detailed descriptions in Chapters 9 through 13 to see which ProDOS 16 calls are different from their ProDOS 8 counterparts.

Still other ProDOS 8 calls have no equivalent in ProDOS 16. They are listed and described under “Eliminated ProDOS 8 System Calls,” in Chapter 1. If your program uses any of these calls, they will have to be replaced as shown.

---

## Modifying interrupt handlers

If you have written an interrupt handling routine, it needs to be updated to conform with the ProDOS 16 interrupt handling conventions. There may be very few changes necessary: it must return with an RTL (Return from subroutine *Long*) rather than an RTS (Return from Subroutine), and it must start and end in 65C816 native mode. See Chapter 7.

---

## Converting stack and zero page

The fixed stack and zero-page locations provided for your program by ProDOS 8 are not available under ProDOS 16. You may either let ProDOS 16 assign you a default 1,024-byte space, or you may define a direct-page/stack segment in your object code. In either case, the loader may place the segment anywhere in bank \$00—you cannot depend on any specific address being within the space. See “Stack and Direct Page,” earlier in this chapter.



---

## Compilation/assembly

Once your source code has been modified and augmented as desired, you need to recompile/reassemble it. You must use an assembler or compiler that produces object files in Apple IIGS object module format (OMF); otherwise the program cannot be properly linked and loaded for execution. Using a different compiler or assembler may mean that, in addition to modifying your program code, you might have to change some assembler directives to follow the syntax of the new assembler.

If you have been using the EDASM assembler, you will not be able to use it to write Apple IIGS programs. The Apple IIGS Programmer's Workshop is a set of development programs that allow you to produce and edit source files, assemble/compile object files, and link them into proper OMF load files. See "Apple IIGS Programmer's Workshop" in this chapter.

After your revised program is linked, assign it the proper Apple IIGS application file type (normally \$B3) with the APW File Type utility.

---

---

## Apple IIGS Programmer's Workshop

The Apple IIGS Programmer's Workshop (APW) is a powerful set of development programs designed to facilitate the creation of Apple IIGS applications. If you are planning to write programs for the Apple IIGS, APW will make your job much easier. The Workshop includes the following components:

- Shell
- Editor
- Linker
- Debugger
- Assembler
- C Compiler

All these components work together (under the Shell) to speed the writing, compiling or assembling, and debugging of programs. The Shell acts as a command interpreter and an interface to ProDOS 16, providing several operating system functions and file utilities that can be called by users and by programs running under the Shell.

See the following manuals for more information on the Apple IIGS Programmer's Workshop:

- *Apple IIGS Programmer's Workshop Reference* (describes the Shell, Editor, Linker, and Debugger)
- *Apple IIGS Programmer's Workshop Assembler Reference*
- *Apple IIGS Programmer's Workshop C Reference*

---

---

## Human Interface Guidelines

All people who develop application programs for the Apple IIGS computer are strongly encouraged to follow the principles presented in *Human Interface Guidelines: The Apple Desktop Interface*. That manual describes the **desktop user interface** through which the computer user communicates with his computer and the applications running on it. This section briefly outlines a few of the human interface concepts; please refer to the manual for specific design information.

The Apple Desktop Interface, first introduced with the Macintosh™ computer, is designed to appeal to a nontechnical audience. Whatever the purpose or structure of your application, it will communicate with the user in a consistent, standard, and non-threatening manner if it adheres to the Desktop Interface standards. These are some of the basic principles:

- **Human control:** Users should feel that they are controlling the program, rather than the reverse. Give them clear alternatives to select from, and act on, their selections consistently.
- **Dialog:** There should be a clear and friendly dialog between human and computer. Make messages and requests to the user in plain English.
- **Direct Manipulation and Feedback:** The user's physical actions should produce physical results. When a key is pressed, place the corresponding letter on the screen. Use highlighting, animation, and dialog boxes to show users the possible actions and their consequences.
- **Exploration:** Give the user permission to test out the possibilities of the program without worrying about negative consequences. Keep error messages infrequent. Warn the user when risky situations are approached.

- **Graphic design:** Good graphic design is a key feature of the guidelines. Objects on the screen should be *simple* and *clear*, and they should have *visual fidelity* (that is, they should look like what they represent). *Icons* and *palettes* are common graphic elements that need careful design.
- **Avoiding modes:** a *mode* is a portion of an application that the user has to formally enter and leave, and that restricts the operations that can be performed while it's in effect. By restricting the user's options, modes reinforce the idea that computers are unnatural and unfriendly. Use modes sparingly.
- **Device-independence:** Make your program as hardware-independent as possible. Don't bypass the tools and resources in ROM—your program may become incompatible with future products and features.
- **Consistency:** As much as possible, all applications should use the same interface. Don't confuse the user with a different interface for each program.
- **Evolution:** Consistency does not mean that you are restricted to using existing desktop features. New ideas are essential for the evolution of the Human Interface concept. If your application has a feature that is described in *Human Interface Guidelines*, you should implement it exactly as described; if it is something new, make sure it cannot be confused with an existing feature. It is better to do something completely different than to half agree with the guidelines.



## Chapter 7



# Adding Routines to ProDOS 16

This chapter discusses additional specific routines that may be used with ProDOS 16. Because these routines are directly connected to ProDOS 16 and interact with it at a low level, they are essentially transparent to applications and can be considered “part of” ProDOS 16. Interrupt handlers are the only such extensions to ProDOS 16 presently supported.

---

---

## Interrupt handlers

The Apple IIGS has extensive firmware interrupt support (see *Apple IIGS Firmware Reference*). In addition, ProDOS 16 supports up to 16 user-installed interrupt handlers (see Chapter 4). If you write an interrupt handler, it should follow the conventions described here. Note also the precautions you must take if your handler makes operating system calls.

---

## Interrupt handler conventions

Interrupt handling routines written for the Apple IIGS must follow certain conventions. The interrupt dispatcher will set the following machine state before passing control to an interrupt handler:

e = 0  
m = 0  
x = 0  
i = 1  
c = 1  
speed = high

Before returning to ProDOS 16, the interrupt handler must restore the machine to the following state:

e = 0  
m = 0  
x = 0  
i = 1  
speed = high



In addition the *c* flag must be cleared (= 0) if the handler serviced the interrupt, and set (= 1) if the handler did not service the interrupt. The handler must return with an RTL instruction.

When an interrupt is passed to ProDOS 16, ProDOS 16 first sets the processor to full native mode, then successively polls the installed interrupt handlers. If one of them services the interrupt, ProDOS 16 knows because it checks the value of the *c* flag when the routine returns. If the *c* flag is cleared, ProDOS 16 switches back to a standard Apple II configuration in emulation mode, and performs an RTI to the Apple IIGS firmware interrupt handling system. If *no* handler services the interrupt, it is an unclaimed interrupt and it will result in system failure (see Chapter 4).

---

## Installing interrupt handlers

Interrupt handlers are installed with the `ALLOC_INTERRUPT` call and removed with the `DEALLOC_INTERRUPT` call. The ProDOS 16 interrupt dispatcher maintains an **interrupt vector table**, an array of up to 16 vectors to interrupt handlers. As each successive `ALLOC_INTERRUPT` call is made, the dispatcher adds another entry to the end of the table. Each time a `DEALLOC_INTERRUPT` call is made to delete a vector from the table, the remaining vectors are moved toward the beginning of the array, filling in the gap. Interrupt handling routines are polled by ProDOS 16 in the order in which their vectors occur in the interrupt vector table.

There is no way to reorder interrupt vectors except by allocating and deallocating interrupts. Interrupts that occur often or require fast service should be allocated first, so their vectors will be near the beginning of the interrupt vector table. If you need *extremely* fast interrupt service, install your interrupt handler directly in the Apple IIGS firmware interrupt dispatcher, rather than through ProDOS 16. See *Apple IIGS Firmware Reference* for further information.

Be sure to enable the hardware generating the interrupt only *after* the routine to handle it is allocated; likewise, disable the hardware *before* the routine is deallocated. Otherwise, a fatal unclaimed interrupt error may occur (see “Unclaimed Interrupts” in Chapter 4).

---

## Making operating system calls during interrupts

ProDOS 16 is not reentrant. That is, it does not save its own state when interrupted. It therefore is illegal to make an operating system call while another operating system call is in progress; if a call is attempted, ProDOS 16 will return an error (number \$07, "ProDOS is busy").

For applications this is not a problem; the operating system is always free to accept a call from them. Only routines that are started through interrupts (such as interrupt handlers and desk accessories) need be careful not to call ProDOS 16 while it is busy.

One acceptable procedure is for the interrupt handler to consult the ProDOS busy flag at location \$E100BE-\$E100BF (see Table 3-3), and simply not make the system call unless ProDOS 16 is not busy.

If an interrupt handler really needs to make an operating system call, it must be prepared to deal with a returned "ProDOS is busy" error. If that happens the handler should

1. Defer itself temporarily
2. Return control to the operating system so that the operating system may complete the current call
3. Regain control when the operating system is no longer busy, and make its own system call

The Scheduler, part of a ROM-based tool set, allows interrupt handlers to follow these procedures in a simple, standard way. The Scheduler consults a system **Busy word** that keeps track of non-reentrant system software that is in use. ProDOS 16 executes the Scheduler routine INCBUSYFLAG whenever it is called, and DECBUSYFLAG before it returns from a call. An interrupt handler may use the Scheduler's SCHADDTASK routine to place itself in a queue of tasks waiting for ProDOS 16 to complete any calls in progress. See *Apple IIGS Toolbox Reference* for detailed information.



## Part II



# ProDOS 16 System Call Reference

This part of the manual describes the ProDOS 16 system calls in detail. The calls are grouped into five categories:

- File housekeeping calls (Chapter 9)
- File access calls (Chapter 10)
- Device calls (Chapter 11)
- Environment calls (Chapter 12)
- Interrupt control calls (Chapter 13)

Chapter 8 shows how to make the calls, and explains the format for the call descriptions in Chapters 9 through 13. See Appendix E for a list of all ProDOS 16 errors returned by the calls.



## Chapter 8



# Making ProDOS 16 Calls

Any independent program in the Apple IIGS that makes system calls is known as a ProDOS 16 *calling program* or *caller*. The current application, a desk accessory, and an interrupt handler are examples of potential callers. A ProDOS 16 caller makes a system call by executing a **call block**. The call block contains a pointer to a **parameter block**. The parameter block is used for passing information between the caller and the called function; additional information about the call is reflected in the state of certain hardware registers. This chapter discusses these aspects of system calls and compares them with the calling method used in ProDOS 8.

- ❖ *Note:* The phrase *system call* as used here is synonymous with *operating system call* or *ProDOS 16 call*, and is equivalent to **MLI call** for ProDOS 8. It includes all calls to the operating system for accessing system information and manipulating open or closed files. It is not restricted to what are called “system calls” in the *ProDOS 8 Technical Reference Manual*.

---

---

## The call block

A system call block consists of a JSL (Jump to Subroutine Long) to the ProDOS 16 entry point, followed by a 2-byte system call number and a 4-byte parameter block pointer. ProDOS 16 performs the requested function, if possible, and returns execution to the instruction immediately following the call block.

All applications written for the Apple IIGS under ProDOS 16 must use the system call block format. When making the call, the caller may have the processor in emulation mode or full native mode or any state in between (see *Technical Introduction to the Apple IIGS*).

- ❖ *Note:* To call ProDOS 16 while running in emulation mode, your program must be in bank \$00 and interrupts must be disabled.





---

## Types of parameters

Each field in a parameter block contains a single parameter. There are three types of parameters: values, results, and pointers. Each is either an *input* to ProDOS 16 from the caller, or an *output* from ProDOS 16 to the caller. The minimum field size for a parameter is one **word** (2 bytes; see Table 3-1).

- A **value** is a numerical quantity, 1 or more words long, that the caller passes to ProDOS 16 through the parameter block. It is an *input* parameter.
- A **result** is a numerical quantity, 1 or more words long, that ProDOS 16 places into the parameter block for the caller to use. It is an *output* parameter.
- <sup>a</sup> A **pointer** is the 4-byte (**long word**) address of a location containing data, code, an address, or buffer space in which ProDOS 16 can receive or place data. The pointer itself is an input for all ProDOS 16 calls; the data it points to may be either *input* or *output*.

A parameter may be both a value and a result. Also, a pointer may designate a location that contains a value, a result, or both.

- ❖ *Note:* A handle is a special type of pointer; it is a pointer to a pointer. It is the 4-byte address of a location that *itself* contains the address of a location containing data, code, or buffer space. ProDOS 16 uses a handle parameter only in the OPEN call (Chapter 10); in that call the handle is an *output* (result).

---

## Parameter block format

All parameter fields that contain block numbers, block counts, file offsets, byte counts, and other file or volume dimensions are 4 bytes long. Requiring 4-byte fields ensures that ProDOS 16 will accommodate future large devices using **guest file systems**.

All parameter fields contain an even number of bytes, for ease of manipulation by the 16-bit 65C816 processor. Thus pointers, for example, are 4 bytes long even though 3 bytes are sufficient to address any memory location. Wherever such extra bytes occur they must be set to zero by the caller; if they are not, compatibility with future versions of ProDOS 16 will be jeopardized.

Pointers in the parameter block must be written with the low-order byte of the low-order word at the lowest address.

Comparison of ProDOS 16 parameter blocks with their ProDOS 8 counterparts reveals that in some cases the order of parameters is slightly different. These alterations have been made to facilitate sharing a single parameter block among a number of calls. For example, most file access calls can be made with a single parameter block for each open file; under ProDOS 8 this sharing of parameter blocks is not possible.

---

**Important**

A parameter's field width in a ProDOS 16 parameter block is often very different from the range of permissible values for that parameter. The fact that all fields are an even number of bytes is one reason. Another reason is that certain fields are larger than presently needed in anticipation of the requirements of future guest file systems. For example, the ProDOS 16 CREATE call's parameter block includes a 4-byte `aux_type` field, even though, on disk, the `aux_type` field is only 2 bytes wide (see "Format and Organization of Directory Files" in Appendix A). The two high-order bytes in the field must therefore always be zero.

Ranges of permissible values for all parameters are given as part of the system call descriptions in the following chapters. When coding a parameter block, note carefully the range of permissible values for each parameter, and make sure that the value you assign is within that range.

---

---

## Setting up a parameter block in memory

Each ProDOS 16 call uses a 4-byte pointer to point to its parameter block, which may be anywhere in memory. All applications must obtain needed memory from the Memory Manager, and therefore cannot know in advance where the memory block holding such a parameter block will be.

There are two ways to set up a ProDOS 16 parameter block in memory:

1. Code the block directly into the program, referencing it with a label. This is the simplest and most typical way to do it. The parameter block will always be correctly referenced, no matter where in memory the program code is loaded.

2. Use Memory Manager and System Loader calls to place the block in memory:
  - a. Request a memory block of the proper size from the Memory Manager. Use the procedures described in *Apple IIGS Toolbox Reference*. The block should be either *fixed* or *locked*.
  - b. Obtain a pointer to the block, by dereferencing the memory handle returned by the Memory Manager (that is, read the contents of the location pointed to by the handle, and use that value as a pointer to the block).
  - c. Set up your parameter block, starting at the address pointed to by the pointer obtained in step (b).

---

---

## Register values

There are no register requirements on entry to a ProDOS 16 call. ProDOS 16 saves and restores all registers except the accumulator (A) and the processor status register (P); those two registers store information on the success or failure of the call. On exit, the registers have these values:

A	zero if call successful; if nonzero, number is the error code
X	unchanged
Y	unchanged
S	unchanged
D	unchanged
P	(see below)
DB	unchanged
PB	unchanged
PC	address of location following the parameter block pointer

“Unchanged” means that ProDOS 16 initially saves, and then restores when finished, the value the register had just before the JSR PRODOS 8 instruction.



On exit, the processor status register (P) bits are

n	undefined
v	undefined
m	unchanged
x	unchanged
d	unchanged
i	unchanged
z	undefined
c	zero if call successful, 1 if not
e	unchanged

❖ *Note:* ProDOS 16 treats several flags differently than ProDOS 8. The n and z flags are undefined here; under ProDOS 8, they are set according to the value in the accumulator. Here the caller may check the c flag to see if an error has occurred; under ProDOS 8, both the c and z flags determine error status.

---

---

## Comparison with the ProDOS 8 call method

With the exceptions noted in Chapter 1, ProDOS 16 provides an identical call for each ProDOS 8 system call. The ProDOS 16 call performs exactly the same function as its ProDOS 8 equivalent, but it is in a format that fits the Apple IIGS environment:

- As in ProDOS 8, the system call is issued through a subroutine jump to a fixed system entry point. However, the jump instruction is a JSL rather than a JSR, and it is to a location in bank \$E1, rather than bank \$00.
- The parameter block pointer in the system call is 4 bytes long rather than 2, so the parameter block can be anywhere in memory.
- All memory pointer fields within the parameter block are also 4 bytes long, so they can reference data anywhere in memory.
- All 1-byte parameters are extended to 1 word in length, for efficient manipulation in 16-bit processor mode.
- All file-position (such as EOF) and block-specification (such as block number or block count) fields in the parameter block are 4 bytes long, in anticipation of future **guest file systems** that may support files larger than 16 Mb or volumes larger than 32 Mb.



- ❖ *Note:* Although only 3 bytes are needed for memory pointers and block numbers in the Apple IIGS, 4-byte pointers are used for ease of programming. The high-order byte in each case is reserved and must be zero.

---

---

## The ProDOS 16 Exerciser

To help you learn to make ProDOS 16 calls, there is a small program called the *ProDOS 16 Exerciser*, on a disk included with this manual. It allows you to execute system calls from a menu, and examine the results of your calls. It has a hexadecimal memory editor for reviewing and altering the contents of memory buffers, and it includes a catalog command.

When you use the *Exerciser* to make a ProDOS 16 call, you first request the call by its call number and then specify its parameter list, just as if you were coding the call in a program. The call is executed when you press Return. You may then use the memory editor or catalog command to examine the results of your call.

Instructions for using the ProDOS 16 *Exerciser* program are in Appendix C.

---

---

## Format for system call descriptions

The following five chapters list and describe all ProDOS 16 operating system functions that may be called by an application.

Each description includes these elements:

- the function's name and call number
- a short explanation of its use
- a diagram of its required parameter block
- a detailed description of all parameters in the parameter block
- a list of all possible operating system error messages.

The parameter block diagram accompanying each call's description is a simplified representation of the parameter block in memory. The width of the diagram represents one byte; the numbers down the left side represent byte offsets from the base address of the parameter block. Each parameter field is further identified as containing a value, result, or pointer.

The detailed parameter description that follows the diagram has the following headings:

- **Offset:** The position of the parameter (relative to the block's base address)
- **Label:** The suggested assembly-language label for the parameter
- **Description:** Detailed information on the parameter, including:

**parameter name:** The full name of the parameter.

**size and type:** The size of the parameter (word or long word), and its classification (value, result, or pointer). A word is 2 bytes; a long word is 4 bytes.

**range of values:** The permissible range of values of the parameter. A parameter may have a range much smaller than its size in bytes.

Any additional explanatory information on the parameter follows.

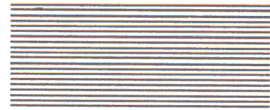

## Chapter 9



# File Housekeeping Calls

These calls might also be called “closed-file” calls; they are made to get and set information about files that need not be open when the calls are made. They do not alter the *contents* of the files they access.

The ProDOS 16 file housekeeping calls are described in this order:

Number	Function	Purpose
\$01	CREATE	creates a new file
\$02	DESTROY	deletes a file
\$04	CHANGE_PATH	changes a file's pathname
\$05	SET_FILE_INFO	assigns attributes to a file
\$06	GET_FILE_INFO	returns a file's attributes
\$08	VOLUME	returns the volume on a device
\$09	SET_PREFIX	assigns a pathname prefix
\$0A	GET_PREFIX	returns a pathname prefix
\$0B	CLEAR_BACKUP_BIT	zeroes a file's backup attribute

---

---

## CREATE (\$01)

Every disk file except the volume directory file (and any Apple II Pascal region on a partitioned disk) must be created with this call. It establishes a new directory entry for an empty file.

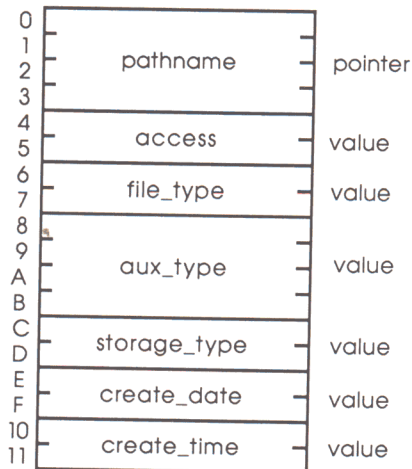

### CREATE (\$01) Parameter block

#### Parameter description

Offset	Label	Description
\$00-\$03	pathname	<b>parameter name:</b> pathname <b>size and type:</b> long word pointer (high-order byte zero) <b>range of values:</b> \$0000 0000-\$00FF FFFF

The long word address of a buffer. The buffer contains a length byte followed by an ASCII string representing the pathname of the file to create.



## Parameter description (continued)

Offset	Label	Description
--------	-------	-------------

\$04-\$05	access	<p><b>parameter name:</b> access</p> <p><b>size and type:</b> word value (high-order byte zero)</p> <p><b>range of values:</b> \$0000-\$00E3 with exceptions</p>
-----------	--------	--

A word whose low-order byte determines how the file may be accessed. The access byte's format is

Bit:	7	6	5	4	3	2	1	0
Value:	D	RN	B	reserved		W	R	

where

- D = destroy-enable bit
- RN = rename-enable bit
- B = backup-needed bit
- W = write-enable bit
- R = read-enable bit

and for each bit, 1 = enabled, 0 = disabled. Bits 2 through 4 are reserved and must always be set to zero (disabled). The most typical setting for the access byte is \$C3 (11000011).

\$06-\$07	file_type	<p><b>parameter name:</b> file type</p> <p><b>size and type:</b> word value (high-order byte zero)</p> <p><b>range of values:</b> \$0000-\$00FF</p>
-----------	-----------	---

A number that categorizes the file by its contents (such as text file, binary file, ProDOS 16 application). Currently defined file types are listed in Appendix A.

\$08-\$0B	aux_type	<p><b>parameter name:</b> auxiliary type</p> <p><b>size and type:</b> long word value (high-order word zero)</p> <p><b>range of values:</b> \$0000 0000-\$0000 FFFF</p>
-----------	----------	---

A number that indicates additional attributes for certain file types. Example uses of the auxiliary type field are given in Appendix A.

Parameter description (continued)

Offset	Label	Description
\$0C-\$0D	storage_type	<p><b>parameter name:</b> storage type  <b>size and type:</b> word value/result (high-order byte zero)  <b>range of values:</b> \$0000-\$000D with exceptions</p> <p>A number that describes the logical organization of the file (see Appendix A):</p> <p>\$00 = inactive entry            \$01 = seedling file            \$02 = sapling file            \$03 = tree file            \$04 = Apple II Pascal region on a partitioned disk            \$0D = directory file</p> <p>\$01 and \$0D are the most typical input values for this field in the CREATE call; any value in the range \$00 through \$03 is automatically converted to an input (and output) of \$01.</p> <p>❖ <i>Note:</i> \$0E and \$0F are not valid storage types; they are subdirectory and volume key block identifiers.</p>

\$0E-\$0F	create_date	<p><b>parameter name:</b> creation date  <b>size and type:</b> word value  <b>range of values:</b> limited range</p> <p>The date on which the file was created. Its format is</p>
-----------	-------------	---

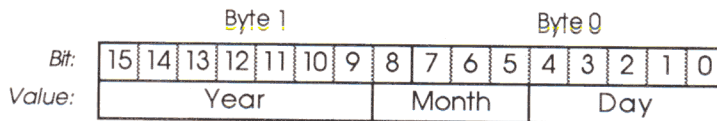

If the value in this field is zero, ProDOS 16 supplies the date obtained from the system clock.

## Parameter description (continued)

Offset	Label	Description
\$10-\$11	create_time	<b>parameter name:</b> creation time <b>size and type:</b> word value <b>range of values:</b> limited range

The time at which the file was created. Its format is

	Byte 1						Byte 0									
Bit:	15	14	13	12	11	10	9	8	7	6	5	4	3	2	1	0
Value:	0	0	0	Hour			0	0	Minute							

If the value in this field is zero, ProDOS 16 supplies the time obtained from the system clock.

## Possible ProDOS 16 errors

\$07	ProDOS is busy
\$10	Device not found
\$27	I/O error
\$2B	Disk write-protected
\$40	Invalid pathname syntax
\$44	Path not found
\$45	Volume not found
\$46	File not found
\$47	Duplicate pathname
\$48	Volume full
\$49	Volume directory full
\$4B	Unsupported storage type
\$52	Unsupported volume type
\$53	Invalid parameter
\$58	Not a block device
\$5A	Block number out of range

---

---

## DESTROY (\$02)

This function deletes the file specified by pathname. It removes the file's entry from the directory that owns it and returns the file's blocks to the volume bit map.

Volume directory files, files with unrecognized storage types (other than \$01, \$02, \$03, or \$0D), and open files cannot be destroyed. Subdirectory files must be empty before they can be destroyed.

❖ *Note:* When a file is destroyed, any index blocks it contains are inverted—that is, the first half of the block and the second half swap positions. That reverses the order of the bytes in all pointers the block contains. Disk scavenging programs can use this information to help recover accidentally deleted files. See Appendix A for a description of index block structure.

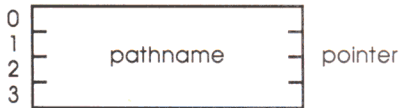

**DESTROY (\$02)**  
Parameter block

### Parameter description

Offset	Label	Description
\$00-\$03	pathname	<b>parameter name:</b> pathname <b>size and type:</b> long word pointer (high-order byte zero) <b>range of values:</b> \$0000 0000-\$00FF FFFF

The long word address of a buffer. The buffer contains a length byte followed by an ASCII string representing the pathname of the file to delete.

---

## Possible ProDOS 16 errors

\$07	ProDOS is busy
\$10	Device not found
\$27	I/O error
\$2B	Disk write-protected
\$40	Invalid pathname syntax
\$44	Path not found
\$45	Volume not found
\$46	File not found
\$4A	Version error
\$4B	Unsupported storage type
\$4E	Access: file not destroy-enabled
\$50	File is open
\$52	Unsupported volume type
\$58	Not a block device
\$5A	Block number out of range



---

---

## CHANGE\_PATH (\$04)

This function performs an intravolume file move. It moves a file's directory entry from one subdirectory to another within the same volume (the file itself is never moved). The specified pathname and new pathname may be either full or partial pathnames in the same volume. See Chapter 5 for an explanation of partial pathnames.

To rename a volume, the specified pathname and new pathname must be volume names only.

If the two pathnames are identical except for the rightmost file name (that is, if both the old and new names are in the same subdirectory), this call produces the same result as the `RENAME` call in ProDOS 8.



### CHANGE\_PATH (\$04)

Parameter block

- ❖ *Note:* In initial releases of ProDOS 16, `CHANGE_PATH` is restricted to a filename change only—that is, it is functionally identical to the `RENAME` call in ProDOS 8.

## Parameter description

Offset	Label	Description
\$00-\$03	pathname	<b>parameter name:</b> pathname <b>size and type:</b> long word pointer (high-order byte zero) <b>range of values:</b> \$0000 0000-\$00FF FFFF  The long word address of a buffer. The buffer contains a length byte followed by an ASCII string representing the file's present pathname.
\$04-\$07	new_pathname	<b>parameter name:</b> new pathname <b>size and type:</b> long word pointer (high-order byte zero) <b>range of values:</b> 0000 0000-\$00FF FFFF  The long word address of a buffer. The buffer contains a length byte followed by an ASCII string representing the file's new pathname.

---

## Possible ProDOS 16 errors

\$07	ProDOS is busy
\$27	I/O error
\$2B	Disk write-protected
\$40	Invalid pathname syntax
\$44	Path not found
\$45	Volume not found
\$46	File not found
\$47	Duplicate pathname
\$4A	Version error
\$4B	Unsupported storage type
\$4E	Access: file not rename-enabled
\$50	File is open
\$52	Unsupported volume type
\$57	Duplicate volume
\$58	Not a block device

---

---

## SET\_FILE\_INFO (\$05)

This function modifies the information in the specified file's directory entry. The call can be made whether the file is open or closed; however, any changed access attributes are not recognized by an open file until the next time the file is opened. In other words, this call does not modify the accessibility of memory-resident information.

❖ *Note:* Current versions of ProDOS 16 ignore input values in the `create_date` and `create_time` fields of this function.

0		
1	pathname	pointer
2		
3		
4	access	value
5	file_type	value
6		
7		
8	aux_type	value
9		
A		
B		
C	(null field)	value
D		
E	create_date	value
F	create_time	value
10		
11		
12	mod_date	value
13	mod_time	value
14		
15		

**SET\_FILE\_INFO (\$05)**  
Parameter block

## Parameter description

Offset	Label	Description																		
\$00-\$03	pathname	<p><b>parameter name:</b> pathname  <b>size and type:</b> long word pointer (high-order byte zero)  <b>range of values:</b> \$0000 0000-\$00FF FFFF</p> <p>The long word address of a buffer. The buffer contains a length byte followed by an ASCII string representing the file's pathname.</p>																		
\$04-\$05	access	<p><b>parameter name:</b> access  <b>size and type:</b> word value (high-order byte zero)  <b>range of values:</b> \$0000-\$00E3 with exceptions</p> <p>A word whose low-order byte determines how the file may be accessed. The access byte's format is</p> <table border="1" style="margin-left: 40px;"> <tr> <td style="padding-right: 5px;">Bit:</td> <td style="border: 1px solid black; padding: 2px;">7</td> <td style="border: 1px solid black; padding: 2px;">6</td> <td style="border: 1px solid black; padding: 2px;">5</td> <td style="border: 1px solid black; padding: 2px;">4</td> <td style="border: 1px solid black; padding: 2px;">3</td> <td style="border: 1px solid black; padding: 2px;">2</td> <td style="border: 1px solid black; padding: 2px;">1</td> <td style="border: 1px solid black; padding: 2px;">0</td> </tr> <tr> <td style="padding-right: 5px;">Value:</td> <td style="border: 1px solid black; padding: 2px;">D</td> <td style="border: 1px solid black; padding: 2px;">RN</td> <td style="border: 1px solid black; padding: 2px;">B</td> <td colspan="3" style="border: 1px solid black; padding: 2px;">reserved</td> <td style="border: 1px solid black; padding: 2px;">W</td> <td style="border: 1px solid black; padding: 2px;">R</td> </tr> </table> <p>where</p> <ul style="list-style-type: none"> <li>D = destroy-enable bit</li> <li>RN = rename-enable bit</li> <li>B = backup-needed bit</li> <li>W = write-enable bit</li> <li>R = read-enable bit</li> </ul> <p>and for each bit, 1 = enabled, 0 = disabled. Bits 2 through 4 are reserved and must always be set to zero (disabled). The most typical setting for the access byte is \$C3 (11000011).</p>	Bit:	7	6	5	4	3	2	1	0	Value:	D	RN	B	reserved			W	R
Bit:	7	6	5	4	3	2	1	0												
Value:	D	RN	B	reserved			W	R												
\$06-\$07	file_type	<p><b>parameter name:</b> file type  <b>size and type:</b> word value (high-order byte zero)  <b>range of values:</b> \$0000-\$00FF</p> <p>A number that categorizes the file by its contents (such as text file, binary file, ProDOS 16 application). Currently defined file types are listed in Appendix A.</p>																		
\$08-\$0B	aux_type	<p><b>parameter name:</b> auxiliary type  <b>size and type:</b> long word value (high-order word zero)  <b>range of values:</b> \$0000 0000-\$0000 FFFF</p> <p>A number that indicates additional attributes for certain file types. Example uses of the auxiliary type field are given in Appendix A.</p>																		

Parameter description (continued)

Offset	Label	Description
--------	-------	-------------

\$0C-\$0D (null field) **parameter name:** (none)  
**size and type:** word value  
**range of values:** (undefined)  
 Values in this field are ignored.

\$0E-\$0F create\_date **parameter name:** creation date  
**size and type:** word value  
**range of values:** limited range  
 The date on which the file was created. Its format is

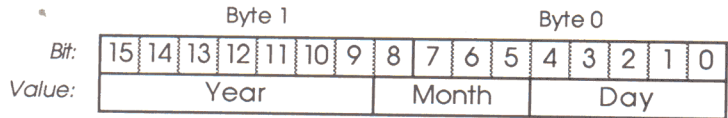

(Values in this field are ignored.)

\$10-\$11 create\_time **parameter name:** creation time  
**size and type:** word value  
**range of values:** limited range

The time at which the file was created. Its format is

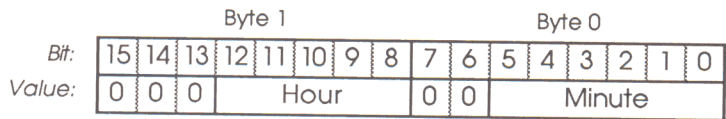

(Values in this field are ignored.)

\$12-\$13 mod\_date **parameter name:** modification date  
**size and type:** word value  
**range of values:** limited range

The date on which the file was last modified. Its format is identical to the create\_date format:

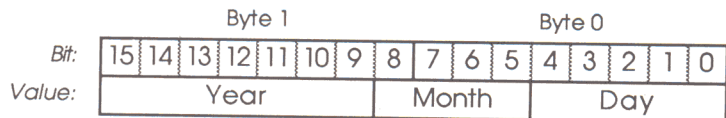

If the value in this field is zero, ProDOS 16 supplies the date obtained from the system clock.



## Parameter description (continued)

Offset	Label	Description
\$14-\$15	mod_time	<b>parameter name:</b> modification time <b>size and type:</b> word value <b>range of values:</b> limited range  The time at which the file was last modified. Its format is identical to the create_time format:

	Byte 1						Byte 0									
Bit:	15	14	13	12	11	10	9	8	7	6	5	4	3	2	1	0
Value:	0	0	0	Hour			0	0	Minute							

If the value in this field is zero, ProDOS 16 supplies the time obtained from the system clock.

### Possible ProDOS 16 errors

\$07	ProDOS is busy
\$27	I/O error
\$2B	Disk write-protected
\$40	Invalid pathname syntax
\$44	Path not found
\$45	Volume not found
\$46	File not found
\$4A	Version error
\$4B	Unsupported storage type
\$4E	Access: file not write-enabled
\$52	Unsupported volume type
\$53	Invalid parameter
\$58	Not a block device

---

---

## GET\_FILE\_INFO (\$06)

This function returns the information that is stored in the specified file's directory entry. The call can be made whether the file is open or closed. However, if you make the SET\_FILE\_INFO call to change the access byte of an open file, the access information returned by GET\_FILE\_INFO may not be accurate until the file is closed.

0	pathname	pointer
1		
2		
3	access	result
4		
5	file_type	result
6		
7	aux_type or total_blocks	result
8		
9		
A	storage_type	result
B		
C	create_date	result
D		
E	create_time	result
F		
10	mod_date	result
11		
12	mod_time	result
13		
14	blocks_used	result
15		
16		
17		
18		
19		

### GET\_FILE\_INFO (\$06)

Parameter block

## Parameter description

Offset	Label	Description																		
\$00-\$03	pathname	<p><b>parameter name:</b> pathname  <b>size and type:</b> long word pointer (high-order byte zero)  <b>range of values:</b> \$0000 0000-\$00FF FFFF</p> <p>The long word address of a buffer. The buffer contains a length byte followed by an ASCII string representing the pathname.</p>																		
\$04-\$05	access	<p><b>parameter name:</b> access  <b>size and type:</b> word result (high-order byte zero)  <b>range of values:</b> \$0000-\$00E3 with exceptions</p> <p>A word whose low-order byte determines how the file may be accessed. The access byte's format is</p> <table border="1" style="margin-left: 40px;"> <tr> <td style="text-align: right;">Bit:</td> <td>7</td> <td>6</td> <td>5</td> <td>4</td> <td>3</td> <td>2</td> <td>1</td> <td>0</td> </tr> <tr> <td style="text-align: right;">Value:</td> <td>D</td> <td>RN</td> <td>B</td> <td colspan="3">reserved</td> <td>W</td> <td>R</td> </tr> </table> <p>where</p> <ul style="list-style-type: none"> <li>D = destroy-enable bit</li> <li>RN = rename-enable bit</li> <li>B = backup-needed bit</li> <li>W = write-enable bit</li> <li>R = read-enable bit</li> </ul> <p>and for each bit, 1 = enabled, 0 = disabled. Bits 2 through 4 are reserved and must always be set to zero (disabled). The most typical setting for the access byte is \$C3 (11000011).</p>	Bit:	7	6	5	4	3	2	1	0	Value:	D	RN	B	reserved			W	R
Bit:	7	6	5	4	3	2	1	0												
Value:	D	RN	B	reserved			W	R												
\$06-\$07	file_type	<p><b>parameter name:</b> file type  <b>size and type:</b> word result (high-order byte zero)  <b>range of values:</b> \$0000-\$00FF</p> <p>A number that categorizes the file by its contents (such as text file, binary file, ProDOS 16 application). Currently defined file types are listed in Appendix A.</p>																		

Parameter description (continued)

Offset	Label	Description
\$08-\$0B	aux_type	<p><b>parameter name:</b> auxiliary type  <b>size and type:</b> long word result (high-order word zero)  <b>range of values:</b> \$0000 0000-\$0000 FFFF</p> <p>A number that indicates additional attributes for certain file types. Example uses of the auxiliary type field are given in Appendix A.</p> <p><i>or</i></p> <p><b>parameter name:</b> total blocks  <b>size and type:</b> long word result (high-order byte zero)  <b>range of values:</b> \$0000 0000-\$00FF FFFF</p> <p>If the call is for a volume directory file, the total number of blocks on the volume is returned in this field.</p>
\$0C-\$0D	storage_type	<p><b>parameter name:</b> storage type  <b>size and type:</b> word result (high-order byte zero)  <b>range of values:</b> \$0000-\$000D with exceptions</p> <p>A number that describes the logical organization of the file (see Appendix A):</p> <p>\$00 = inactive entry            \$01 = seedling file            \$02 = sapling file            \$03 = tree file            \$04 = UCSD Pascal region on a partitioned disk            \$0D = directory file</p> <p>❖ <i>Note:</i> \$0E and \$0F are not valid storage types; they are subdirectory and volume key block identifiers.</p>
\$0E-\$0F	create_date	<p><b>parameter name:</b> creation date  <b>size and type:</b> word result  <b>range of values:</b> limited range</p> <p>The date on which the file was created. Its format is</p>

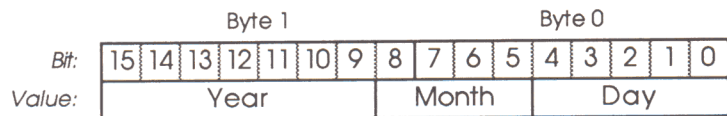

Parameter description (continued)

Offset	Label	Description
--------	-------	-------------

\$10-\$11      create\_time      **parameter name:** creation time  
**size and type:**      word result  
**range of values:**      limited range

The time at which the file was created. Its format is

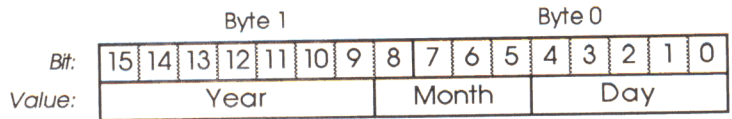

\$12-\$13      mod\_date      **parameter name:** modification date  
**size and type:**      word result  
**range of values:**      limited range

The date on which the file was last modified. Its format is identical to the create\_date format:

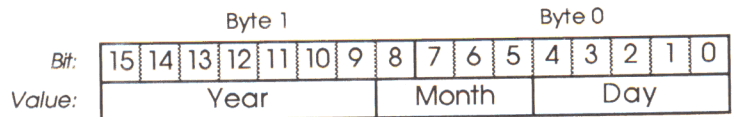

\$14-\$15      mod\_time      **parameter name:** modification time  
**size and type:**      word result  
**range of values:**      limited range

The time at which the file was last modified. Its format is identical to the create\_time format:

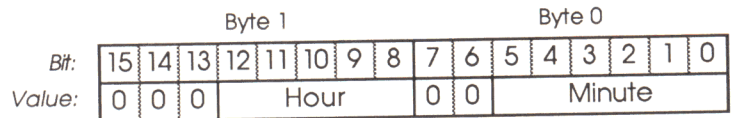



\$16-\$19

blocks\_used

**parameter name:** blocks used  
**size and type:** long word result  
**range of values:** \$0000 0000-\$FFFF FFFF

The total number of blocks used by the file. It equals the value of the blocks\_used parameter in the file's directory entry.

*or*

The total number of blocks used by all files on the volume (if the call is for a volume directory).

---

### Possible ProDOS 16 errors

\$07 <sup>a</sup>	ProDOS is busy
\$27	I/O error
\$40	Invalid pathname syntax
\$44	Path not found
\$45	Volume not found
\$46	File not found
\$4A	Version error
\$4B	Unsupported storage type
\$52	Unsupported volume type
\$53	Invalid parameter
\$58	Not a block device

## VOLUME (\$08)

0		
1		
2	dev_name	pointer
3		
4		
5	vol_name	pointer
6		
7		
8		
9	total_blocks	result
A		
B		
C		
D	free_blocks	result
E		
F		
10	file_sys_id	result
11		

**VOLUME (\$08)**  
Parameter block

When given the name of a device, this function returns:

- the name of the volume that occupies that device
- the total number of blocks on the volume
- the current number of free (unallocated) blocks on the volume
- the file system identification number of the volume

The volume name is returned with a leading slash (/).

To generate a list of all mounted volumes (equivalent to calling ON\_LINE in ProDOS 8 with a unit number of zero), call VOLUME repeatedly with successive device names (.D1, .D2, and so on).

When there are no more online volumes to name, ProDOS 16 returns error \$11 (Invalid device request).

❖ *Note:* In certain cases (for example, when polling Disk II drives) ProDOS 16 cannot detect the difference between an empty device and a nonexistent device. It may therefore assign a device name where there is no device connected, just to make sure it hasn't skipped over an empty device. Because of this, in making VOLUME calls, you may occasionally find that there are more "valid" device names than there are devices on line.

### Parameter description

Offset	Label	Description
\$00-\$03	dev_name	<p><b>parameter name:</b> device name</p> <p><b>size and type:</b> long word pointer (high-order byte zero)</p> <p><b>range of values:</b> \$0000 0000-\$00FF FFFF</p> <p>The long word address of a buffer. The buffer contains a length byte followed by an ASCII string representing the device name.</p>
\$04-\$07	vol_name	<p><b>parameter name:</b> volume name</p> <p><b>size and type:</b> long word pointer (high-order byte zero)</p> <p><b>range of values:</b> \$0000 0000-\$00FF FFFF</p> <p>The long word address of a buffer. The buffer contains a length byte followed by an ASCII string representing the volume name (including a leading slash).</p>

## Parameter description (continued)

Offset	Label	Description
\$08-\$0B	total_blocks	<p><b>parameter name:</b> total blocks  <b>size and type:</b> long word result (high-order byte zero)  <b>range of values:</b> \$0000 0000-\$00FF FFFF</p> <p>The total number of blocks the volume contains.</p>
\$0C-\$0F	free_blocks	<p><b>parameter name:</b> free blocks  <b>size and type:</b> long word result (high-order byte zero)  <b>range of values:</b> \$0000 0000-\$00FF FFFF</p> <p>The number of free (unallocated) blocks in the volume.</p>
\$10-\$11	file_sys_id	<p><b>parameter name:</b> file system ID  <b>size and type:</b> word result (high-order byte zero)  <b>range of values:</b> \$0000-\$00FF</p> <p>A word whose low-order byte identifies the file system to which the specified file or volume belongs. The currently defined file system identification numbers include</p> <ul style="list-style-type: none"> <li>0 = {reserved}</li> <li>1 = ProDOS/SOS</li> <li>2 = DOS 3.3</li> <li>3 = DOS 3.2, 3.1</li> <li>4 = Apple II Pascal</li> <li>5 = Macintosh</li> <li>6 = Macintosh (HFS)</li> <li>7 = LISA®</li> <li>8 = Apple CP/M</li> <li>9-255 = {reserved}</li> </ul>

---

## Possible ProDOS 16 errors

\$07	ProDOS is busy
\$10	Device not found
\$11	Invalid device request
\$27	I/O error
\$28	No device connected
\$2E	Disk switched: files open
\$2F	Device not on line
\$40	Invalid pathname
\$45	Volume not found
\$4A	Version error
\$52	Unsupported volume type
\$55	Volume control block full
\$57	Duplicate volume
\$58	Not a block device

---

---

## SET\_PREFIX (\$09)

This function assigns any of 8 prefix numbers to the pathname indicated by the pointer `prefix`. A prefix number consists of a digit followed by a slash: 0/, 1/, 2/,..., 7/. When an application starts, the prefixes have default values that depend on the manner in which the program was launched. See Chapter 5.

The input pathname to this call may be

- a full pathname.
- a partial pathname with a prefix number. The trailing slash on the prefix number is optional.
- a partial pathname with the special prefix number \*/ (asterisk-slash), which means "boot volume name." The trailing slash is optional.
- a partial pathname without a prefix number. In this case ProDOS 16 does *not* attach the default prefix (number 0/). Instead, it *appends* the input pathname to the prefix specified in the `prefix_num` field.

❖ *Note:* This method can be used to append a partial pathname to an *existing* prefix only. If the specified prefix is presently null, error \$40 (invalid pathname syntax) is returned.

Specifying a pathname whose length byte is zero, or whose syntax is otherwise illegal, sets the designated prefix to null (unassigned).

❖ *Note:* ProDOS 16 does *not* check to make sure that the designated volume is on line when you specify a prefix; it only checks the pathname string for correct syntax.

The boot volume prefix (\*/) cannot be changed through this call.

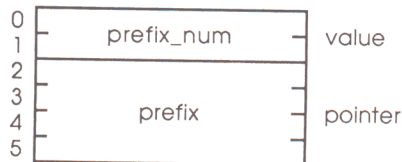

**SET\_PREFIX (\$09)**  
Parameter block



## Parameter description

Offset	Label	Description
\$00-\$01	prefix_num	<b>parameter name:</b> prefix number <b>size and type:</b> word value <b>range of values:</b> \$0000-\$0007  One of the 8 prefix numbers, in binary (without a terminating slash).
\$02-\$05	prefix	<b>parameter name:</b> prefix <b>size and type:</b> long word pointer (high-order byte zero) <b>range of values:</b> \$0000 0000-\$00FF FFFF  The long word address of a buffer. The buffer contains a length byte followed by an ASCII string representing a directory pathname.

---

### Possible ProDOS 16 errors

\$07	ProDOS is busy
\$40	Invalid pathname syntax
\$53	Parameter out of range

## GET\_PREFIX (\$0A)

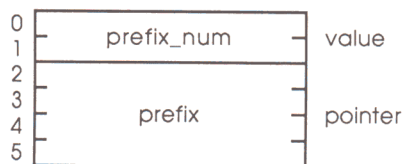

### GET\_PREFIX (\$0A) Parameter block

This function returns any of the current prefixes (specified by number), placing it in the buffer pointed to by *prefix*. The returned prefix is bracketed by slashes (such as /APPLE/ or /APPLE/BYTES/). If the requested prefix has been set to null (see SET\_PREFIX), a count of zero is returned as the length byte in the prefix buffer.

The boot volume prefix (\*/) cannot be returned by this call. Instead, use GET\_BOOT\_VOL to find the boot volume's name.

### Parameter description

Offset	Label	Description
\$00-\$01	prefix_num	<p><b>parameter name:</b> prefix number  <b>size and type:</b> word value  <b>range of values:</b> \$0000-\$0007</p> <p>One of the 8 prefix numbers, in binary (without a terminating slash).</p>
\$02-\$05	prefix	<p><b>parameter name:</b> prefix  <b>size and type:</b> long word pointer (high-order byte zero)  <b>range of values:</b> \$0000 0000-\$00FF FFFF</p> <p>The long word address of a buffer, in which ProDOS 16 places a length byte followed by an ASCII string representing a directory pathname.</p>

### Possible ProDOS 16 errors

\$07	ProDOS is busy
\$53	Parameter out of range

---

---

## CLEAR\_BACKUP\_BIT (\$0B)

This is the only call that will clear the backup bit in a file's access byte. Once cleared, the bit indicates that the file has not been altered since the last backup. ProDOS 16 automatically resets the backup bit every time a file is altered.

---

**Important** Only disk backup programs should use this function!

---



### CLEAR\_BACKUP\_BIT (\$0B)

Parameter block

#### Parameter description

---

Offset	Label	Description
\$00-\$03	pathname	<b>parameter name:</b> pathname <b>size and type:</b> long word pointer (high-order byte zero) <b>range of values:</b> \$0000 0000-\$00FF FFFF

The long word address of a buffer. The buffer contains a length byte followed by an ASCII string representing the file's pathname.

---

#### Possible ProDOS 16 errors

\$07	ProDOS is busy
\$40	Invalid pathname syntax
\$44	Path not found
\$45	Volume not found
\$46	File not found
\$4A	Version error
\$52	Unsupported volume type
\$58	Not a block device



## Chapter 10



### File Access Calls

These might be called "open-file" calls. They are made to access and change the information *within* files, and therefore in most cases the files must be open before the calls can be made.

The ProDOS 16 file access calls are described in the following order:

Number	Function	Purpose
\$10	OPEN	prepares file for access
\$11	NEWLINE	enables newline read mode
\$12	READ	transfers data from file
\$13	WRITE	transfers data to file
\$14	CLOSE	ends access to file
\$15	FLUSH	empties I/O buffer to file
\$16	SET_MARK	sets current position in file
\$17	GET_MARK)	returns current position in file
\$18	SET_EOF	sets size of file
\$19	GET_EOF	returns size of file
\$1A	SET_LEVEL	sets system file level
\$1B	GET_LEVEL	returns system file level



## OPEN (\$10)

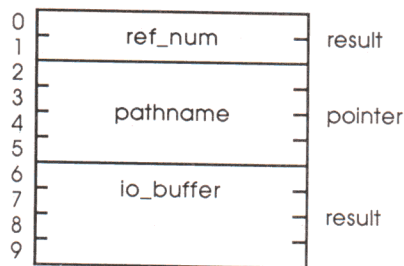

This function prepares a file to be read from or written to. It creates a file control block (FCB) that keeps track of the current characteristics of the file specified by pathname. It sets the current position in the file (Mark) to zero, and returns a reference number (*ref\_num*) for the file; subsequent file access calls must refer to the file by its reference number. It also returns a memory handle to a 1024-byte I/O buffer used by ProDOS 16 for reading from and writing to the file.

Up to 8 files may be open simultaneously.

❖ *Note:* Normally, attempting to open a file that is already open causes an error (\$50). However, if a file is not *write-enabled*, it may be opened more than once.

### OPEN (\$10)

Parameter block

#### Parameter description

Offset	Label	Description
\$00-\$01	ref_num	<p><b>parameter name:</b> reference number  <b>size and type:</b> word result (high-order byte zero)  <b>range of values:</b> \$0001-\$00FF</p> <p>An identifying number assigned to the file by ProDOS 16. It is used in place of the pathname in all subsequent file access calls.</p>
\$02-\$05	pathname	<p><b>parameter name:</b> pathname  <b>size and type:</b> long word pointer (high-order byte zero)  <b>range of values:</b> \$0000 0000-\$00FF FFFF</p> <p>The long word address of a buffer. The buffer contains a length byte followed by an ASCII string representing the pathname of the file to open.</p>
\$06-\$09	io_buffer	<p><b>parameter name:</b> I/O buffer  <b>size and type:</b> long word result (high-order byte zero)  <b>range of values:</b> \$0000 0000-\$00FF FFFF</p> <p>A memory handle. It points to a location where the address of the I/O buffer allocated by ProDOS 16 is stored.</p>

---

## Possible ProDOS 16 errors

\$07	ProDOS is busy
\$27	I/O error
\$40	Invalid pathname syntax
\$42	File control block table full
\$44	Path not found
\$45	Volume not found
\$46	File not found
\$4A	Version error
\$4B	Unsupported storage type
\$50	File is open
\$52	Unsupported volume type

---

---

## NEWLINE (\$11)

This function enables or disables the **newline** read mode for an open file. When newline is disabled, a `READ` call (described next) terminates only when the requested number of characters has been read (unless the end of the file is encountered first). When newline is enabled, the `READ` will also terminate when a newline character (as defined in the parameter block) is read.

When a `READ` call is made and newline mode is enabled,

1. Each character read in is first transferred to the user's data buffer.
2. The character is ANDed with the low-order byte of the newline enable mask (specified in the `NEWLINE` call's parameter block).
3. The result is compared with the low-order byte of the newline character.
4. If there is a match, the read is terminated.

The enable mask is typically used to mask off unwanted bits in the character that is read in. For example, if the mask value is `$7F` (binary `0111 1111`), a newline character will be correctly matched whether or not its high bit is set. If the mask value is `$FF` (`1111 1111`), the character will pass through the AND operation unchanged.

Newline read mode is disabled by setting the enable mask to `$0000`.

0	ref_num	result
1		
2	enable_mask	value
3		
4	newline_char	value
5		

**NEWLINE (\$11)**  
Parameter block

## Parameter description

Offset	Label	Description
\$00-\$01	ref_num	<b>parameter name:</b> reference number <b>size and type:</b> word result (high-order byte zero) <b>range of values:</b> \$0001-\$00FF  The identifying number assigned to the file by the OPEN function.
\$02-\$03	enable_mask	<b>parameter name:</b> enable mask <b>size and type:</b> word value (high-order byte zero) <b>range of values:</b> \$0000-\$00FF  The current character is ANDed with the low order byte of this word.
\$04-\$05	newline_char	<b>parameter name:</b> newline character <b>size and type:</b> word value (high-order byte zero) <b>range of values:</b> \$0000-\$00FF  Whatever character occupies the low-order byte of this field is defined as the newline character.

---

### Possible ProDOS 16 errors

\$07	ProDOS is busy
\$43	Invalid reference number

---

---

## READ (\$12)

When called, this function attempts to transfer the requested number of bytes (starting at the current position of the file specified by *ref\_num*) into the buffer pointed to by *data\_buffer*. When finished, the function returns the number of bytes actually transferred.

If, during a read, the end-of-file is reached before *request\_count* bytes have been read, *transfer\_count* is set to the number of bytes transferred. If newline mode is enabled and a newline character is encountered before *request\_count* bytes have been read, *transfer\_count* is set to the number of bytes transferred (including the newline byte).

No more than 16,777,215 (\$FF FF FF) bytes may be read in a single call.

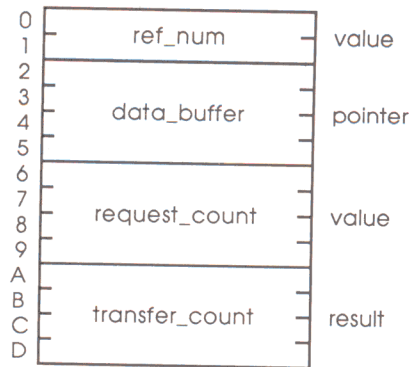

**READ (\$12)**  
Parameter block



## Parameter description

---

Offset	Label	Description
\$00-\$01	ref_num	<b>parameter name:</b> reference number <b>size and type:</b> word value (high-order byte zero) <b>range of values:</b> \$0001-\$00FF  The identifying number assigned to the file by the OPEN function.
\$02-\$05	data_buffer	<b>parameter name:</b> data buffer <b>size and type:</b> long word pointer (high-order byte zero) <b>range of values:</b> \$0000 0000-\$00FF FFFF  The long word address of a buffer. The buffer should be large enough to hold the requested data.
\$06-\$09	request_count	<b>parameter name:</b> request count <b>size and type:</b> long word value (high-order byte zero) <b>range of values:</b> \$0000 0000-\$00FF FFFF  The number of bytes to be transferred.
\$0A-\$0D	transfer_count	<b>parameter name:</b> transfer count <b>size and type:</b> long word result (high-order byte zero) <b>range of values:</b> \$0000 0000-\$00FF FFFF  The actual number of bytes transferred.

---

## Possible ProDOS 16 errors

\$07	ProDOS is busy
\$27	I/O error
\$43	Invalid reference number
\$4C	EOF encountered (Out of data)
\$4E	Access: file not read-enabled

---

---

## WRITE (\$13)

When called, this function attempts to transfer the specified number of bytes from the buffer pointed to by *data\_buffer* to the file specified by *ref\_num* (starting at the current position in the file). When finished, the function returns the number of bytes actually transferred.

After a write, the current file position (Mark) is increased by the transfer count. If necessary, the end-of-file (EOF) is extended to accommodate the new data.

No more than 16,777,216 (\$FF FF FF) bytes may be written in a single call.

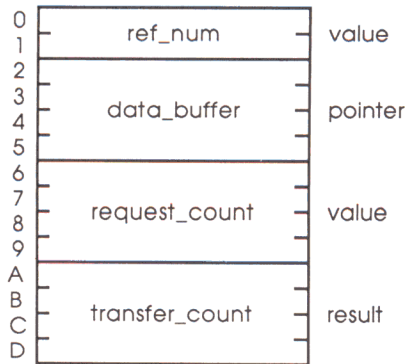

### WRITE (\$13)

Parameter block

## Parameter description

Offset	Label	Description
\$00-\$01	ref_num	<b>parameter name:</b> reference number <b>size and type:</b> word value (high-order byte zero) <b>range of values:</b> \$0001-\$00FF  The identifying number assigned to the file by the OPEN function.
\$02-\$05	data_buffer	<b>parameter name:</b> data buffer <b>size and type:</b> long word pointer (high-order byte zero) <b>range of values:</b> \$0000 0000-\$00FF FFFF  The long word address of a buffer. The buffer should be large enough to hold the requested data.
\$06-\$09	request_count	<b>parameter name:</b> request count <b>size and type:</b> long word value (high-order byte zero) <b>range of values:</b> \$0000 0000-\$00FF FFFF  The number of bytes to be transferred.
\$0A-\$0D	transfer_count	<b>parameter name:</b> transfer count <b>size and type:</b> long word result (high-order byte zero) <b>range of values:</b> \$0000 0000-\$00FF FFFF  The actual number of bytes transferred.

---

## Possible ProDOS 16 errors

\$07	ProDOS is busy
\$27	I/O error
\$2B	Disk write-protected
\$43	Invalid reference number
\$48	Volume full
\$4E	Access: file not write-enabled
\$5A	Block number out of range

---

---

## CLOSE (\$14)

This function is called to release all resources used by an open file and terminate further access to it. The file control block (FCB) is released; if necessary, the file's I/O buffer is emptied (written to disk) and the directory entry for the file is updated. Once a file is closed, any subsequent calls using its `ref_num` will fail (until that number is assigned to another open file).

If the specified `ref_num` is 0, all open files at or above the current file level (see `SET_LEVEL` and `GET_LEVEL` calls) are closed. For example, if files are open at levels 0, 1, and 2 and you have set the current level to 1, a `CLOSE` call with `ref_num` set to 0 will close all files at levels 1 and 2, but leave files at level 0 open.

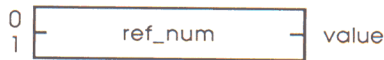

### CLOSE (\$14)

Parameter block

#### Parameter description

Offset	Label	Description
\$00-\$01	<code>ref_num</code>	<b>parameter name:</b> reference number <b>size and type:</b> word value (high-order byte zero) <b>range of values:</b> \$0000-\$00FF

The identifying number assigned to the file by the `OPEN` function.

---

### Possible ProDOS 16 errors

\$07	ProDOS is busy
\$27	I/O error
\$2B	Disk write-protected
\$43	Invalid reference number
\$5A	Block number out of range

---

---

## FLUSH (\$15)

This function is called to empty an open file's buffer and update its directory. If `ref_num` is zero, all open files are flushed.

❖ *Note:* Current versions of ProDOS 16 ignore `ref_num` in this call. The FLUSH call flushes all open files.

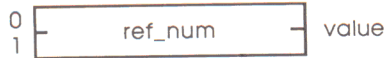

### FLUSH (\$15)

Parameter block

#### Parameter description

Offset	Label	Description
\$00-\$01	ref_num	<b>parameter name:</b> reference number <b>size and type:</b> word value (high-order byte zero) <b>range of values:</b> \$0000-\$00FF

The identifying number assigned to the file by the OPEN function.

---

### Possible ProDOS 16 errors

\$07	ProDOS is busy
\$27	I/O error
\$2B	Disk write-protected
\$43	Invalid reference number
\$48	Volume full
\$5A	Block number out of range



---

---

## SET\_MARK (\$16)

For the specified open file, this function sets the current position (Mark, the position at which subsequent reading and writing will occur) to the point specified by the position parameter. The value of the current position may not exceed EOF (end-of-file; the size of the file in bytes).

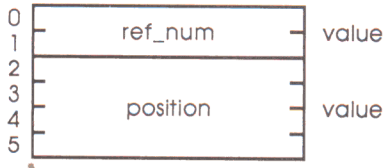

**SET\_MARK (\$16)**  
Parameter block

### Parameter description

Offset	Label	Description
\$00-\$01	ref_num	<b>parameter name:</b> reference number <b>size and type:</b> word value (high-order byte zero) <b>range of values:</b> \$0001-\$00FF  The identifying number assigned to the file by the OPEN function.
\$02-\$05	position	<b>parameter name:</b> position <b>size and type:</b> long word value (high-order byte zero) <b>range of values:</b> \$0000 0000-\$00FF FFFF  The value assigned to Mark. It is the position, in bytes relative to the beginning of the file, at which the next read or write will occur.

---

### Possible ProDOS 16 errors

\$07	ProDOS is busy
\$27	I/O error
\$43	Invalid reference number
\$4D	Position out of range
\$5A	Block number out of range

---

---

## GET\_MARK (\$17)

This function returns the current position (Mark, the position at which subsequent reading and writing will occur) for the specified open file.

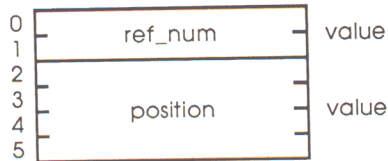

**GET\_MARK (\$17)**  
Parameter block

### Parameter description

Offset	Label	Description
\$00-\$01	ref_num	<b>parameter name:</b> reference number <b>size and type:</b> word value (high-order byte zero) <b>range of values:</b> \$0001-\$00FF  The identifying number assigned to the file by the OPEN function.
\$02-\$05	position	<b>parameter name:</b> position <b>size and type:</b> long word result (high-order byte zero) <b>range of values:</b> \$0000 0000-\$00FF FFFF  The current value of Mark. It is the position, in bytes relative to the beginning of the file, at which the next read or write will occur.

---

### Possible ProDOS 16 errors

\$07	ProDOS is busy
\$43	Invalid reference number

---

---

## SET\_EOF (\$18)

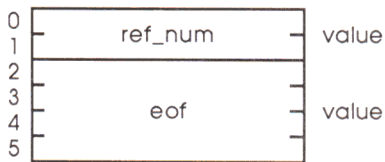

### SET\_EOF (\$18) Parameter block

For the specified file, this function sets its logical size (in bytes) to the value specified by EOF (end-of-file). If the specified EOF is less than the current EOF, then disk blocks past the new EOF are released to the system and index-block pointers to those blocks are zeroed. However, if the specified EOF is equal to or greater than the current EOF, no new blocks are allocated until data are actually written to them.

The value of EOF cannot be changed unless the file is write-enabled.

### Parameter description

Offset	Label	Description
\$00-\$01	ref_num	<b>parameter name:</b> reference number <b>size and type:</b> word value (high-order byte zero) <b>range of values:</b> \$0001-\$00FF
\$04-\$07	eof	<b>parameter name:</b> end-of-file <b>size and type:</b> long word value (high-order byte zero) <b>range of values:</b> \$0000 0000-\$00FF FFFF

The identifying number assigned to the file by the OPEN function.

The specified logical size of the file. It represents the total number of bytes that may be read from the file.

---

## Possible ProDOS 16 errors

\$07	ProDOS is busy
\$27	I/O error
\$43	Invalid reference number
\$4D	Position out of range
\$4E	Access: file not write-enabled
\$5A	Block number out of range

---

---

## GET\_EOF (\$19)

For the specified open file, this function returns its logical size, or EOF (end-of-file; the number of bytes that can be read from it).

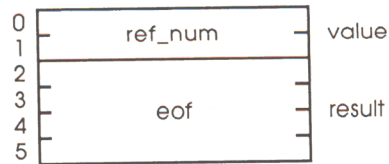

### GET\_EOF (\$19) Parameter block

#### Parameter description

Offset	Label	Description
\$00-\$01	ref_num	<b>parameter name:</b> reference number <b>size and type:</b> word value (high-order byte zero) <b>range of values:</b> \$0001-\$00FF  The identifying number assigned to the file by the OPEN function.
\$04-\$07	eof	<b>parameter name:</b> end-of-file <b>size and type:</b> long word result (high-order byte zero) <b>range of values:</b> \$0000 0000-\$00FF FFFF  The current logical size of the file. It represents the total number of bytes that may be read from the file.

---

#### Possible ProDOS 16 errors

\$07	ProDOS is busy
\$43	Invalid reference number

---

---

## SET\_LEVEL (\$1A)

This function sets the current value of the system file level (see Chapter 2). All subsequent OPEN calls will assign this level to the files opened. All subsequent CLOSE calls for *multiple* files (that is, those calls using a specified ref\_num of 0) will be effective only on those files that were opened when the system level was greater than or equal to the new level.

The range of legal system level values is \$0000-\$00FF. The file level initially defaults to zero.



### SET\_LEVEL (\$1A) Parameter block

#### Parameter description

Offset	Label	Description
\$00-\$01	level	<b>parameter name:</b> system file level <b>size and type:</b> word value (high-order byte zero) <b>range of values:</b> \$0000-\$00FF

The specified value of the system file level.

---

### Possible ProDOS 16 errors

\$07	ProDOS is busy
\$59	Invalid file level



---

---

## GET\_LEVEL (\$1B)

This function returns the current value of the system file level (see Chapter 2). All subsequent OPEN calls will assign this level to the files opened. All subsequent CLOSE calls for *multiple* files (that is, those calls using a specified ref\_num of 0) will be effective only on those files that were opened when the system level was greater than or equal to its current level.



**GET\_LEVEL (\$1B)**  
Parameter block

### Parameter description

Offset	Label	Description
\$00-\$01	level	<b>parameter name:</b> system file level <b>size and type:</b> word result (high-order byte zero) <b>range of values:</b> \$0000-\$00FF  The current value of the system file level.

---

### Possible ProDOS 16 errors

\$07            ProDOS is busy



# Chapter 11



## Device Calls

Device calls access storage devices directly, rather than through the logical structure of the volumes or files on them.

The ProDOS 16 device calls are described in the following order:

Number	Function	Purpose
\$20	GET_DEV_NUM	returns a device's number
\$21	GET_LAST_DEV	returns the last device accessed
\$22	READ_BLOCK	transfers 512 bytes from a device
\$23	WRITE_BLOCK	transfers 512 bytes to a device
\$24	FORMAT	formats a volume in a device

---

---

## GET\_DEV\_NUM (\$20)

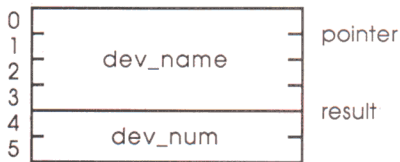

### GET\_DEV\_NUM (\$20)

Parameter block

For the device specified by name or by the name of the volume mounted on it, this function returns its device number. All other device calls (except for `FORMAT`) must refer to the device by its number.

Device numbers are assigned by ProDOS 16 at system startup (boot) time. They are consecutive integers, assigned in the order in which ProDOS 16 polls external devices (see Chapter 4).

❖ *Note:* Because a device may hold different volumes and because volumes may be switched among devices, the device number returned for a particular volume name may change. Likewise, the volume name associated with a particular device number may change.

### Parameter description

Offset	Label	Description
\$00-\$03	dev_name	<b>parameter name:</b> device name/volume name <b>size and type:</b> long word pointer (high-order byte zero) <b>range of values:</b> \$0000 0000-\$00FF FFFF  The long word address of a buffer. The buffer contains a length byte followed by an ASCII string representing the device name or the volume name.
\$04-\$05	dev_num	<b>parameter name:</b> device number <b>size and type:</b> word result (high-order byte zero) <b>range of values:</b> \$0000-\$00FF  The device's reference number, to be used in other device calls.

---

### Possible ProDOS 16 errors

\$07	ProDOS is busy
\$10	Device not found
\$11	Invalid device request
\$40	Invalid device name syntax
\$45	Volume not found

---

---

## GET\_LAST\_DEV (\$21)

This function returns the device number of the last device accessed. The *last device accessed* is the last device to which a command was directed that caused a read or write to occur.

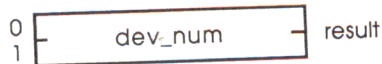

### GET\_LAST\_DEV (\$21)

#### Parameter description

Offset	Label	Description
\$00-\$01	dev_num	<b>parameter name:</b> device number <b>size and type:</b> word result (high-order byte zero) <b>range of values:</b> \$0000-\$00FF The device's reference number, to be used in other device calls.

---

#### Possible ProDOS 16 errors

\$07	ProDOS is busy
\$60	Data unavailable



---

---

## READ\_BLOCK (\$22)

This function reads one block of information from a disk device (specified by *dev\_num*) into memory starting at the address pointed to by *data\_buffer*. The buffer must be at least 512 bytes in length, because existing devices define a block as 512 bytes.

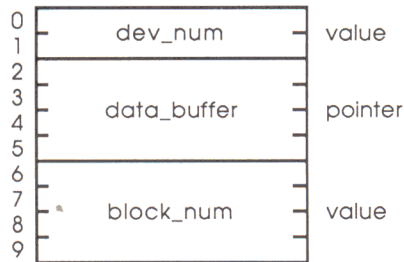

### READ\_BLOCK (\$22) Parameter block

#### Parameter description

Offset	Label	Description
\$00-\$01	dev_num	<b>parameter name:</b> device number <b>size and type:</b> word value (high-order byte zero) <b>range of values:</b> \$0000-\$00FF  The device's reference number, as returned by GET_DEV_NUM.
\$02-\$05	data_buffer	<b>parameter name:</b> data buffer <b>size and type:</b> long word pointer (high-order byte zero) <b>range of values:</b> \$0000 0000-\$00FF FFFF  The long word address of a buffer that will hold the data to be read in.
\$06-\$09	block_num	<b>parameter name:</b> block number <b>size and type:</b> long word value (high-order word zero) <b>range of values:</b> \$0000 0000-\$0000 FFFF  The number of the block to be read in.

---

## Possible ProDOS 16 errors

\$07	ProDOS is busy
\$11	Invalid device request
\$27	I/O error
\$28	No device connected
\$2F	Device not on line
\$53	Parameter out of range

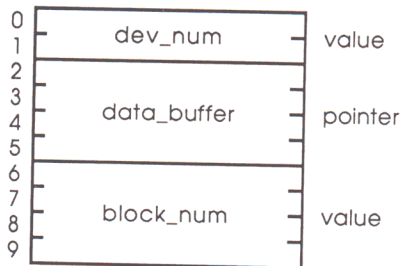

## WRITE\_BLOCK (\$23)

This function transfers one block of data from the memory buffer pointed to by *data\_buffer* to the disk device specified by *dev\_num*. The block is placed in the specified logical block of the volume occupying that device. For currently defined devices, the data buffer must be at least 512 bytes long.

### WRITE\_BLOCK (\$23)

Parameter block

#### Parameter description

Offset	Label	Description
\$00-\$01	dev_num	<p><b>parameter name:</b> device number  <b>size and type:</b> word value (high-order byte zero)  <b>range of values:</b> \$0000-\$00FF</p> <p>The device's reference number, as returned by GET_DEV_NUM.</p>
\$02-\$05	data_buffer	<p><b>parameter name:</b> data buffer  <b>size and type:</b> long word pointer (high-order byte zero)  <b>range of values:</b> \$0000 0000-\$00FF FFFF</p> <p>The long word address of a buffer that holds the data to be written.</p>
\$06-\$09	block_num	<p><b>parameter name:</b> block number  <b>size and type:</b> long word value (high-order word zero)  <b>range of values:</b> \$0000 0000-\$0000 FFFF</p> <p>The number of the block to be written to.</p>

#### Possible ProDOS 16 errors

\$07	ProDOS is busy
\$11	Invalid device request
\$27	I/O error
\$28	No device connected
\$2B	Disk write-protected
\$2F	Device not on line
\$53	Parameter out of range

## FORMAT (\$24)

This function formats the volume (disk) in the specified (by name) device, giving it the specified volume name. The volume is formatted according to the specified file system ID.

- ❖ *Note:* Current versions of ProDOS 16 support formatting for the ProDOS/SOS file system only (file system ID = 1). Specifying any other file system will generate error \$5D.

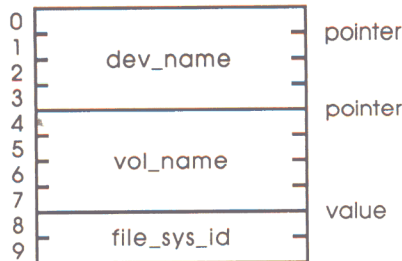

**FORMAT (\$24)**  
Parameter block

### Parameter description

Offset	Label	Description
\$00-\$03	dev_name	<p><b>parameter name:</b> device name  <b>size and type:</b> long word pointer (high-order byte zero)  <b>range of values:</b> \$0000 0000-\$00FF FFFF</p> <p>The long word address of a buffer. The buffer contains a length byte followed by an ASCII string representing the device name.</p>
\$04-\$07	vol_name	<p><b>parameter name:</b> volume name  <b>size and type:</b> long word pointer (high-order byte zero)  <b>range of values:</b> \$0000 0000-\$00FF FFFF</p> <p>The long word address of a buffer. The buffer contains a length byte followed by an ASCII string representing the volume name (including a leading slash).</p>

\$08-\$09

file\_sys\_id

**parameter name:** file system ID  
**size and type:** word result (high-order byte zero)  
**range of values:** \$0000-\$00FF

A word whose low-order byte identifies the file system to which the formatted volume belongs. The currently defined file system identification numbers include

- 0 = {reserved}
- 1 = ProDOS/SOS
- 2 = DOS 3.3
- 3 = DOS 3.2, 3.1
- 4 = Apple II Pascal
- 5 = Macintosh
- 6 = Macintosh (HFS)
- 7 = LISA
- 8 = Apple CP/M

---

### Possible ProDOS 16 errors

\$07	ProDOS is busy
\$10	Device not found
\$11	Invalid device request
\$27	I/O error
\$5D	File system not available





## Chapter 12



### Environment Calls

These calls deal with the Apple IIGS operating environment, the software and hardware configuration within which applications run. They include calls to start and end ProDOS 16 applications, and to determine pathnames and versions of system software.

The ProDOS 16 environment calls are described in the following order:

<b>Number</b>	<b>Function</b>	<b>Purpose</b>
\$27	GET_NAME	returns application filename
\$28	GET_BOOT_VOL	returns ProDOS 16 volume name
\$29	QUIT	terminates present application
\$2A	GET_VERSION	returns ProDOS 16 version

---

---

## GET\_NAME (\$27)

This function returns the filename of the currently running application.

To get the complete pathname of the current application, use `GET_PREFIX` for prefix number 1/, and affix that prefix to the file name returned by this call.

❖ *Note:* If your program uses `SET_PREFIX` to reset prefix 1/ to anything other than its initial value, be sure it first uses `GET_PREFIX` on 1/ and saves the results. Otherwise there may be no way to recover the full pathname of the current application.

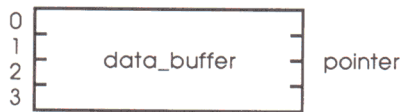

### GET\_NAME (\$27) Parameter block

#### Parameter description

Offset	Label	Description
\$00-\$03	data_buffer	<b>parameter name:</b> data buffer <b>size and type:</b> long word pointer (high-order byte zero) <b>range of values:</b> \$0000 0000-\$00FF FFFF

The long word address of a buffer. The buffer contains a length byte followed by an ASCII string representing the current application's file name.

---

### Possible ProDOS 16 errors

\$07 ProDOS is busy

---

---

## GET\_BOOT\_VOL (\$28)

This function returns the name of the volume from which the file named `PRODOS` was last executed. `PRODOS` is the operating system loader; it loads both `ProDOS 16` and `ProDOS 8` into memory. Execution of `PRODOS` may occur

- at system startup
- from a reboot
- by execution from an Applesoft BASIC dash (`—`) command
- by loading `PRODOS` into memory at `$002000` and executing a `JMP` to that address

The volume name returned by this call is identical to the prefix specified by `*/*`. See Chapter 5.

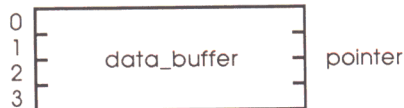

### GET\_BOOT\_VOL (\$28) Parameter block

#### Parameter description

Offset	Label	Description
\$00-\$03	<code>data_buffer</code>	<b>parameter name:</b> <code>data buffer</code> <b>size and type:</b> long word pointer (high-order byte zero) <b>range of values:</b> <code>\$0000 0000-\$00FF FFFF</code>  The long word address of a buffer. The buffer contains a length byte followed by an ASCII string representing the boot volume's name.

---

### Possible ProDOS 16 errors

\$07            ProDOS is busy

---

---

## QUIT (\$29)

Calling this function terminates the present application. It also closes all open files, sets the current system file level to zero, and deallocates any installed interrupt handlers. ProDOS 16 can then do one of three things:

- launch a file specified by the quitting program
- launch a file specified by the user
- automatically launch a program specified in the quit return stack

The **quit return stack** is a table maintained in memory by ProDOS 16. It provides a convenient means for a shell program to pass execution to subsidiary programs (even other shells), while ensuring that control eventually returns to the shell.

For example, a program selector may push its User ID onto the quit return stack whenever it launches an application (by making a `QUIT` call). That program may or may not specify yet another program when it quits, and it may or may not push its own User ID onto the quit return stack. Eventually, however, when no more programs have been specified and no others are waiting for control to return to them, the program selector's User ID will be pulled from the stack and it will be executed once again.

Two `QUIT` call parameters control these options, as follows:

1. Pathname pointer:
  - a. If the pathname pointer in the parameter block points to a pathname of nonzero length, the indicated program is loaded and executed.
  - b. If pathname is null (zero) or if it points to a null pathname (one with a zero length byte), ProDOS 16 pulls a User ID from the quit return stack and executes the program with that ID.
  - c. If pathname is null *and* the quit return stack is empty, ProDOS 16 executes a built-in interactive dispatcher that allows the user to
    - reboot the computer
    - execute the file `SYSTEM/START` on the boot disk
    - enter the name of the next application to launch



## 2. Flag word:

The flag word contains two boolean values: a return flag and a restart-from-memory flag.

- a. If the return flag value is TRUE (bit 15=1), the User ID of the program making the QUIT call is pushed onto the quit return stack. If the return flag is FALSE, no ID is pushed onto the stack.
- b. If the value of the restart-from-memory flag is TRUE (bit 14=1), the program is capable of being restarted from a dormant state in the computer's memory. If the restart-from-memory flag is FALSE, the program must always be reloaded from disk when it is run. Every time a program's User ID is pushed onto the quit return stack, the information from this flag is saved along with it. The System Loader uses this information when it reloads or **restarts** the program later (see Chapter 17).

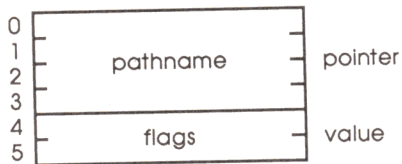

**QUIT (\$29)**  
Parameter block

❖ *Note:* The pathname designated in this call may be a partial pathname with an implied or explicit prefix number. However, the total length of the expanded prefix (the full pathname except for the file name) must not exceed 64 characters. Other ProDOS 16 calls do not restrict pathname length as severely.

Further details of the operation of the QUIT function are explained in Chapter 5.

## Parameter description

Offset	Label	Description								
\$00-\$03	pathname	<p><b>parameter name:</b> pathname  <b>size and type:</b> long word pointer (high-order byte zero)  <b>range of values:</b> \$0000 0000-\$00FF FFFF</p> <p>The long word address of a buffer. The buffer contains a length byte followed by an ASCII string representing the pathname of the next file to execute.</p>								
\$04-\$05	flags	<p><b>parameter name:</b> flag word  <b>size and type:</b> word value  <b>range of values:</b> \$0000-\$C000</p> <p>Two boolean flags in a 16-bit field. The bits are defined as follows:</p> <table border="0"> <thead> <tr> <th>bit</th> <th>significance</th> </tr> </thead> <tbody> <tr> <td>15</td> <td>if = 1, place calling program's User ID on return stack</td> </tr> <tr> <td>14</td> <td>if = 1, calling program may be restarted from memory</td> </tr> <tr> <td>13-0</td> <td>(reserved)</td> </tr> </tbody> </table>	bit	significance	15	if = 1, place calling program's User ID on return stack	14	if = 1, calling program may be restarted from memory	13-0	(reserved)
bit	significance									
15	if = 1, place calling program's User ID on return stack									
14	if = 1, calling program may be restarted from memory									
13-0	(reserved)									

---

## Possible ProDOS 16 errors

QUIT never returns to the caller. Therefore, it cannot return an error. However, other parts of ProDOS 16 may. For example, if an interrupting program (such as a desk accessory) ignores established conventions and uses a QUIT call, error \$07 (ProDOS is busy) may occur. For programming rules covering such specialized applications, see *Programmer's Introduction to the Apple IIGS*.

If a nonfatal error occurs, execution passes to an interactive routine that allows the user to select another program to launch. Errors that may cause this include:

\$07	ProDOS is busy
\$40	Invalid syntax
\$46	File not found
\$5C	Not an executable file
\$5D	Operating system not available
\$5E	Cannot deallocate /RAM
\$5F	Return stack overflow

Fatal errors cause execution to halt. For example, if the QUIT call results in the loading of a ProDOS 8-based application, and if the system disk has been altered with a different version of ProDOS 8 (file P8), it is a fatal error (\$11). Execution halts and the following message is displayed on the screen:

```
Wrong OS version $0011
```

If the QUIT call results in the loading of a ProDOS 16-based application that is too large to fit in the available memory or that for some other reason cannot be loaded, execution halts and the following message is displayed on the screen:

```
Can't run next application. Error=$XXXX
```

where \$XXXX is an error code—typically a Tool Locator, Memory Manager, or System Loader error code.

---

---

## GET\_VERSION (\$2A)

This function returns the version number of the currently running ProDOS 16 operating system.

The returned version number is placed in the version parameter field. Both byte and bit values are significant. It has this format:

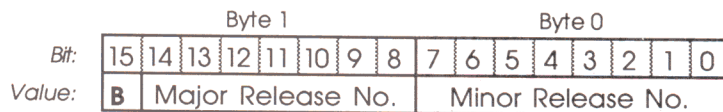

- Byte 0 is the minor release number ( = 0 for ProDOS 16 version 1.0)
- Byte 1 is the major release number ( = 1 for ProDOS 16 version 1.0)
- B (the most significant bit of byte 1) = 0 for final releases  
= 1 for all prototype releases



### GET\_VERSION (\$2A)

Parameter block

#### Parameter description

Offset	Label	Description
\$00-\$01	version	<b>parameter name:</b> version <b>size and type:</b> word result (high-order byte zero) <b>range of values:</b> \$0000-\$FFFF  The version number of ProDOS 16.

---

### Possible ProDOS 16 errors

\$07 ProDOS is busy



## Chapter 13



# Interrupt Control Calls



These calls allocate and deallocate interrupt handling routines.

The ProDOS 16 interrupt control calls are described in the following order:

<b>Number</b>	<b>Function</b>	<b>Purpose</b>
\$31	ALLOC_INTERRUPT	installs an interrupt handler
\$32	DEALLOC_INTERRUPT	removes an interrupt handler

---

---

## ALLOC\_INTERRUPT (\$31)

This function places the address of an interrupt-handling routine into the interrupt vector table. You should make this call before enabling the hardware that can cause the interrupt. It is your responsibility to make sure that the routine is installed at the proper location and that it follows interrupt conventions (see Chapter 7).

The returned `int_num` is a reference number for the handler. Its only use is to identify the handler when deallocating it; you must refer to a routine by its interrupt handler number to remove it from the system (with `DEALLOC_INTERRUPT`).

When ProDOS 16 receives an interrupt, it polls the installed handlers in sequence, according to their order in the interrupt vector table. The first handler installed has the highest priority. Each new handler installed is added to the end of the table; each one deallocated is removed from the list and the table is compacted.

- ❖ *Note:* Under ProDOS 8, the interrupt handler number is equal to the handler's position in the polling sequence. By contrast, the value of `int_num` under ProDOS 16 is unrelated to the order in which handlers are polled.

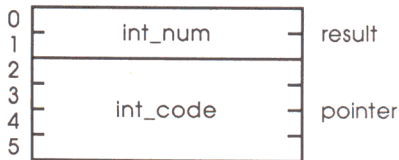

**ALLOC\_INTERRUPT (\$31)**  
Parameter block

## Parameter description

Offset	Label	Description
\$00-\$01	int_num	<b>parameter name:</b> interrupt handler number <b>size and type:</b> word result (high-order byte zero) <b>range of values:</b> \$0000-\$00FF  The identifying number assigned to the interrupt handler by ProDOS 16.
\$02-\$05	int_code	<b>parameter name:</b> interrupt code <b>size and type:</b> long word pointer (high-order byte zero) <b>range of values:</b> \$0000 0000-\$00FF FFFF  The long word address of the interrupt handler routine.

---

### Possible ProDOS 16 errors

\$07	ProDOS is busy
\$25	Interrupt vector table full
\$53	Invalid parameter

---

---

## DEALLOC\_INTERRUPT (\$32)

This function clears the entry (specified by *int\_num*) for an interrupt handler from the interrupt vector table.

**Important** You must disable the associated interrupt hardware before making this call. A fatal error will result if a hardware interrupt occurs after its entry has been cleared from the vector table.

DEALLOC\_INTERRUPT has no effect on the order of the polling sequence for the remaining handlers. Any subsequently allocated handlers will be added to the end of the polling sequence.

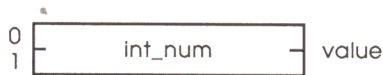

### DEALLOC\_INTERRUPT (\$32)

Parameter block

#### Parameter description

Offset	Label	Description
\$00-\$01	int_num	<b>parameter name:</b> interrupt handler number <b>size and type:</b> word value (high-order byte zero) <b>range of values:</b> \$0000-\$00FF  The identifying number assigned to the interrupt handler by ProDOS 16.

---

#### Possible ProDOS 16 errors

\$07	ProDOS is busy
\$53	Invalid parameter



## Part III



# The System Loader

The System Loader is an Apple IIGS tool set that works closely with ProDOS 16. It is responsible for loading all program code and data into the Apple IIGS memory. It is capable of static and dynamic loading and relocating of code and data segments, subroutines, and libraries.

Chapter 14 explains in general terms how the System Loader works. Chapter 15 details some of its functions and data structures. Chapter 16 gives programming suggestions for using the System Loader. Chapter 17 shows how to make loader calls and describes each call in detail. See Appendix E for a complete list of System Loader error codes.





## Chapter 14



# Introduction to the System Loader

This chapter gives a basic picture of the System Loader, defines some of the important terms needed to explain what the loader does, describes its interactions with the Memory Manager, and presents an outline of the procedures it follows when loading a program into memory. Additional related terms are defined in the Glossary.

---

---

## What is the System Loader?

The System Loader is a set of software routines that manages the loading of program segments into the Apple IIGS. It is an Apple IIGS tool set; as such, it is independent of ProDOS 16. However, it works very closely with ProDOS 16 and with the Memory Manager, another tool set. The System Loader has several improvements over the loading method under ProDOS 8 on other Apple II computers:

- It makes loading easier and more convenient. Under ProDOS 8, the only automatic loading is performed by the boot code, which searches the boot disk for the first .SYSTEM file (type \$FF) and loads it into location \$2000. If a system program needs to call another application it must do all the work itself, either by making ProDOS 8 calls or by providing its own loader. On the Apple IIGS, calls to the System Loader perform the task more simply.
- It is a *relocating loader*: it loads relocatable programs at any available location in memory. Under ProDOS 8, a program must be loaded at a fixed memory address, or at an address specified by the system program that does the loading. The relocating loader relieves the programmer of the burden (and restriction) of deciding where to load programs.
- It is a *segment loader*: it can load different segments of a program independently, to use memory efficiently.
- It is a *dynamic loader*: it can load certain program segments as they are needed during execution, rather than at boot time only.

The System Loader handles files generated by the **APW Linker**; the linker handles files produced by an Apple IIGS **assembler** or **compiler**. The linker, assembler, and compilers are part of the **Apple IIGS Programmer's Workshop** (APW), a powerful and flexible set of development programs designed to help programmers produce Apple IIGS applications efficiently and conveniently. See Chapter 6 of this manual for more information and references on Apple IIGS Programmer's Workshop.

---

---

## Loader terminology

The System Loader is a program that processes **load files**. Load files are ProDOS 16 applications or other types of program files. They contain machine-language code or data and must follow object module format (OMF) specifications, as defined in the *Apple IIGS Programmer's Workshop Reference*. Each load file consists of **load segments** that can be loaded into memory independently.

Load segments can be either **static** or **dynamic**. A program's static segments are loaded into memory at initial load time (when the program is first started up); they must stay in memory until the program is complete. Dynamic load segments, on the other hand, are not placed in memory at initial load time; they are loaded as needed during program execution. Dynamic loading can be automatic (through the **Jump Table**) or manual (at the specific request of the application through System Loader function calls). When a dynamic segment is no longer needed by the program that called it, it can be **purged**, or deleted, by the Memory Manager.

Segments can be **absolute**, **relocatable**, or **position-independent**. An absolute segment must be loaded into a specific location in memory, or it will not function properly. A relocatable segment can execute correctly wherever the System Loader places it. Least restricted of all is a position-independent segment; its functioning is totally unaffected by its location in memory. It can even be moved from one location to another between executions. Most Apple IIGS code is relocatable, but not position-independent.

Load files can contain segments of various kinds. Some segments consist of program code or data; others provide location information to the loader. The **Jump Table segment**, when loaded into memory, provides a mechanism by which segments in memory can trigger the loading of other needed segments. Each load file can have only one Jump Table segment. A load file can also have one segment called the **Pathname segment**, which provides a cross-reference between file numbers (in the Jump Table segment) and pathnames (on disk) of dynamic segments. A third special type of segment is the **initialization segment**. It contains any code that has to be executed first, before the rest of the segments are loaded.

When the System Loader is called to load a program, it loads all static load segments including the Jump Table segment and the Pathname segment. The Jump Table and the **Pathname Table** are constructed from these two segments, respectively. During this process, a **Memory Segment Table** is also constructed in memory. These three tables are discussed in more detail in the next chapter.

A controlling program is a program that requests the System Loader to perform an **initial load** on another major program, usually an application. The **User ID Manager** assigns a unique identification number (User ID) to that application, so the loader may quickly locate all of the application's segments if necessary. A switcher is an example of a controlling program; ProDOS 16 and the APW Shell are also controlling programs. A word processor is an example of an application.

---

---

## Interface with the Memory Manager

The System Loader and the Memory Manager work closely together. The **Memory Manager** is an Apple IIGS tool set (firmware program) that is responsible for allocating memory in the Apple IIGS. It provides space for load segments, tells the System Loader where to place them, and moves segments around within memory when additional space is needed.



When the System Loader loads a program segment, it calls the Memory Manager to allocate a corresponding **memory block**. Memory blocks have attributes that are closely related to the load segments in them. If the program segment is *static*, its memory block is marked as **unpurgeable** (meaning that its contents cannot be erased) and **fixed** (meaning that its position cannot be changed), as long as the program is running. If the program segment is *dynamic*, its memory block is initially marked as **purgeable** but locked (temporarily unpurgeable and fixed; subject to change during execution of the program). If the dynamic segment is *position-independent*, its memory block is marked as **movable**; otherwise, it is fixed.

To **unload** a segment, the System Loader calls the Memory Manager to make the corresponding memory block purgeable. If the controlling program wishes to unload *all* segments associated with a particular application (for example, at shutdown), it calls the System Loader's User Shutdown function, which in turn calls the Memory Manager to purge the application's memory blocks.

To speed up execution of a finder or switcher that may need to rapidly reload shut-down applications, the User Shutdown function can optionally put an application into a dormant state. The loader calls the Memory Manager to purge the application's *dynamic* segments, and make all *static* segments purgeable. This process frees space but keeps the unloaded application's essential segments in memory. However, if for any reason memory runs out and the Memory Manager is forced to purge one of those static segments, that application can no longer be used—the next time it is needed, it must be loaded from its disk file. See "User Shutdown" and "Restart" in Chapter 17.

❖ *Note:* Strictly speaking, load segments are never *purged* or *locked*; those are actions taken on the memory blocks that hold the segments. For simplicity, however, this manual may in certain cases apply terms such as purged or locked to segments.

A typical load segment will be placed in a memory block that is

Locked

Fixed

Purge Level = 0 (if the segment is static)

Purge Level = 3 (if the segment is dynamic)



Depending on other requirements the segment may have, such as alignment in memory, the load segment-memory block relationship may be more complex. Table 14-1 shows all possible relationships between the two that may hold at load time. The direct-page/stack segment has special characteristics described in Chapter 6.

**Table 14-1**  
Load-segment/memory-block relationships (at load time)

Load Segment Attribute	Memory Block Attribute
static	unpurgeable, fixed (unmovable)
dynamic	purgeable, locked
absolute (ORG > 0)	fixed address
relocatable	(no specific relation)
position-independent	not fixed (movable)
not position-independent	fixed (unmovable)
KIND = \$11	fixed-bank
BANKSIZE = 0	may cross bank boundary
BANKSIZE = \$10 000	may not cross bank boundary
ALIGN = 0	not bank- or page-aligned <sup>†</sup>
ALIGN = \$100	page-aligned <sup>†</sup>
ALIGN = \$10 000	bank-aligned <sup>†</sup>
direct-page/stack (KIND = \$12)	purgeable, fixed-bank (\$00), page-aligned

<sup>†</sup>Alignment may also be controlled by the value in the BANKSIZE field—see Appendix D.

❖ *Note:* ORG, KIND, BANKSIZE and ALIGN are segment header fields, described in Appendix D of this manual and under “Object Module Format” in *Apple IIGS Programmer’s Workshop Reference*.

A memory block can be purged through a call to the System Loader, but other attributes can be changed only through Memory Manager calls. Memory block properties useful to an application may include

- Start location
- Size of block
- User ID (identifies the application the block is part of)
- Purge level (0 to 3: 0 = unpurgeable, 3 = most purgeable)

These properties may be accessed either through the Memory Segment Table (see Chapter 15), or through the block's memory handle, which is part of the Memory Segment Table. If the memory handle is NIL (points to a null pointer), the memory block has been purged.

---

---

## Loading a relocatable segment

The following brief description of parts of the operation of the System Loader shows how the linker, loader, and Memory Manager work together to produce and load a relocatable program segment. Figure 14-1 diagrams the process in a simplified form.

---

### Load-file structure

Load files conform to a subset of object module format (OMF). In OMF, each module (file) consists of one or more segments; each segment is further made up of one or more **records**. In a load file specifically, each segment (apart from specialized segments such as the load file tables described in Chapter 15) consists of a header followed by program code or data, in turn followed (if the segment is relocatable) by a **relocation dictionary**. The relocation dictionary is created by the linker as it converts an object segment into a load segment. The program code or data consists of two types of records: LCONST records, which hold all code and data, and DS records, used for filling space with zeros. The relocation dictionary consists of two general types of records: RELOC records, which give the loader the information it needs to resolve local (intra-segment) references, and INTERSEG records, which give the loader the information it needs to resolve external (inter-segment) references. cRELOC, cINTERSEG, and SUPER records are also found in relocation dictionaries—they are compressed versions of RELOC and INTERSEG records. The detailed formats of all OMF records are presented in *Apple IIGS Programmer's Workshop Reference*.

When a relocatable segment is loaded into memory, it is placed at a location determined by the Memory Manager. Furthermore, only the first part of the segment (the program code itself) is loaded into the part of memory reserved by the Memory Manager; the relocation dictionary, if present, is loaded into a buffer or work area used by the loader. After loading the segment, the loader *relocates* it, using the information in the relocation dictionary.

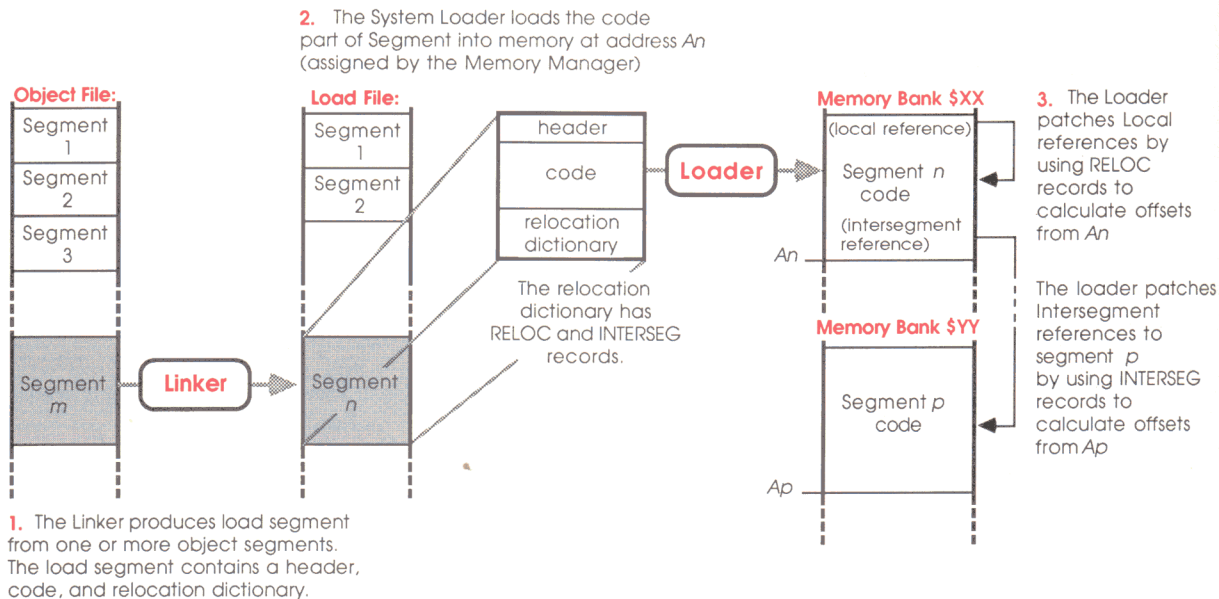

**Figure 14-1**  
Loading a relocatable segment

## Relocation

After the System Loader has placed a load segment in memory, it must (unless the segment consists of absolute code) relocate its address references. **Relocation** describes the processing of a load segment so that it will execute properly at the memory location at which it has been loaded. It consists of **patching** (substituting the proper values for) address operands that refer to locations both within and external to the segment. The relocation dictionary part of the segment contains all the information needed by the loader to do this patching. Relocation is performed as follows:

1. Local references in the load segment (coded in the original object file as offsets from the beginning of the segment) are patched from RELOC records in the relocation dictionary. Using the starting address of the segment (available from the Memory Manager through the Memory Segment Table), the loader adds that address to each offset, so that the correct memory address is referenced.

2. External references (references to other segments) are coded in the original object module as global variables (subroutine names or entry points). The linker and loader handle them as follows:
  - a. If the reference is to a static segment, the *linker* will have calculated the proper file number, segment number, and offset of the referenced (external) segment, and placed that information in an `INTERSEG` record in the relocation dictionary. When the load segment is loaded, the *loader* uses the `INTERSEG` record and the memory location of the external segment (available from the Memory Manager through the Memory Segment Table), and then patches the external reference with the proper memory address of the external segment.
  - b. If the reference is to a dynamic segment, the *linker* will have created a slightly different `INTERSEG` record: instead of referencing the file number, segment, and offset of the referenced external segment itself, the `INTERSEG` record references the file number, segment number, and offset of an entry in the *Jump Table*. Therefore, when the load segment is loaded, the *loader* patches the reference to point to the *Jump Table* entry. That entry, in turn, is what transfers control to the external segment at its proper memory address (if and when the referenced segment is loaded).

The *Jump Table* and the reasons for this indirect referencing are described further in Chapter 15. The main point of interest here is that, when it performs relocation, the loader doesn't care whether an intersegment reference is to a static or to a dynamic segment—it treats both in exactly the same way.

The System Loader performs several other functions when it loads dynamic segments, including searching for the name of the segment in the *Pathname Table* before loading, and patching the appropriate *Jump Table* entry afterward. These and other functions are described in more detail in the next two chapters.



## Chapter 15



# System Loader Data Tables



This chapter describes the data tables set up in memory during a load, to provide cross-reference information to the loader. The Memory Segment Table allows the loader to keep track of which segments have been loaded and where they are in memory. The **Jump Table** allows programs to reference routines in dynamic segments that may not currently be in memory. The Pathname Table provides a cross-reference between file numbers and file pathnames of dynamic segments. The **Mark List** speeds relocation by keeping track of relocation dictionaries.

---



---

## Memory Segment Table

The Memory Segment Table is a linked list, each entry of which describes a memory block known to the System Loader. Memory blocks are allocated by the Memory Manager during loading of segments from a load file, and each block corresponds to a single load segment. Figure 15-1 shows the format of each entry in the Memory Segment Table.

The fields have the following meanings:

**Handle to next entry:** The memory handle of the next entry in the Memory Segment Table. This number is 0 for the last entry.

**Handle to previous entry:** The memory handle of the previous entry in the Memory Segment Table. This number is 0 for the first entry.

**User ID:** The identification number assigned to the memory block this segment inhabits. Normally, the User ID is available directly from the Memory Manager through the memory handle. However, if the block has been purged its handle is NIL and the User ID must be read from this field.

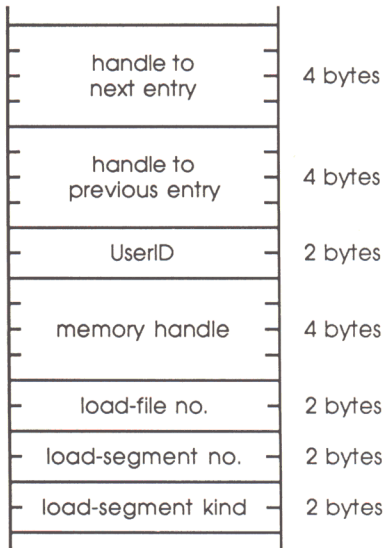

**Figure 15-1**  
Memory Segment Table entry

**Memory handle:** The identifying number of the memory block, obtained from the Memory Manager. Additional memory block information is available through this handle. This handle is NIL if the block has been purged.

**Load-file number:** The number of the load file from which the segment was obtained. If the segment is in the initial load file, the number is 1.

**Load-segment number:** The segment number of the segment in the load file.

**Load-segment kind:** The value of the `KIND` field in the load segment's header. Segment kinds are described in Appendix D.

---

---

## Jump Table

When a program (load file) is initially loaded, only the static load segments are placed in memory; at that point the System Loader has all the information it needs to resolve all symbolic references among them. Until a dynamic segment is loaded, however, the loader cannot resolve references to it because it does not know where in memory it will be. Thus static segments may be directly referenced (by each other and by dynamic segments), but dynamic segments can be referenced only through JSL (Jump to Subroutine Long) calls to the Jump Table. This section describes how that mechanism works.

The Jump Table is a structure that allows a program to reference dynamic segments. It consists of the Jump Table Directory and one or more Jump Table segments.

On disk, Jump Table segments are load segments (of kind `$02`), created by the linker to resolve references to dynamic segments. Any load file or run-time library file may contain a Jump Table segment.

In memory, the Jump Table Directory is created by the loader as it loads Jump Table segments. The Jump Table Directory is a linked list, each entry of which points to a single Jump Table segment encountered by the loader. Figure 15-2 shows the format of an entry in the Jump Table Directory.

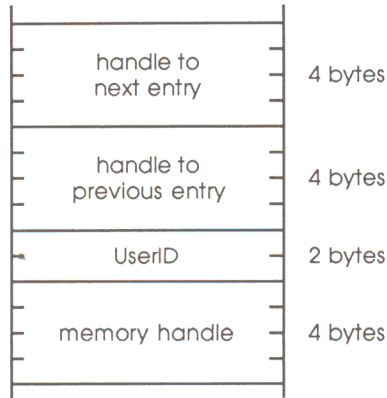

**Figure 15-2**  
Jump Table Directory entry

The fields have the following meanings:

**Handle to next entry:** The memory handle of the next entry in the Jump Table Directory. This number is 0 for the last entry.

**Handle to previous entry:** The memory handle of the previous entry in the Jump Table Directory. This number is 0 for the first entry.

**User ID:** The identification number assigned to the Jump Table segment that this Directory entry refers to.

**Memory handle:** The handle of the memory block containing the Jump Table segment that this Directory entry refers to.

Like the Directory, the individual Jump Table segments consist of a series of entries. The next three subsections describe the creation, loading, and use of a single Jump Table *segment* entry. The entry is used to resolve a single JSL instruction in a program segment.

❖ *Note:* Throughout this manual, the term *Jump Table entry* refers to a Jump Table *segment* entry, not a Jump Table *directory* entry.

## Creation of a Jump Table entry

The Jump Table load segment is created by the linker, as the linker processes an object file. Each time the linker encounters a JSL to a routine in an external dynamic segment, it creates an INTERSEG record in the relocation dictionary of the load segment, and (if it has not done so already) an entry for that routine in the Jump Table segment. The INTERSEG record links the JSL to the Jump Table entry that was just created. Figure 15-3 shows the format of the Jump Table entry that the linker creates. See also section a of Figure 15-5.

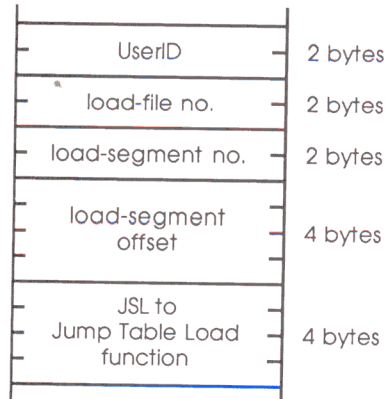

**Figure 15-3**  
Jump Table entry (unloaded state)

The fields have the following meanings:

**User ID:** The User ID of the referenced dynamic segment.

**Load-file number:** The load-file number of the referenced dynamic segment.

**Load-segment number:** The load-segment number of the referenced dynamic segment.

**Load-segment offset:** The location of the referenced address within the referenced dynamic segment.

**JSL to Jump Table Load function:** A long subroutine jump to the Jump Table Load function. The Jump Table Load function is described in Chapter 17.

The final entry in a Jump Table segment has a load-file number of zero, to indicate that there are no more entries in the segment.

---

## Modification at load time

At load time, the loader places the program segment and the Jump Table segment into memory (it does not yet load the referenced dynamic segment). To link the Jump Table segment with any other Jump Table segments it may have loaded, it creates the Jump Table Directory. The Jump Table is now complete.

Using the information in the `INTERSEG` record, the loader patches the `JSL` instruction in the program segment so that it references the proper part of the Jump Table in memory. It also patches the actual address of the Jump Table Load function into the Jump Table entry. The Jump Table entry is now in its *unloaded state*. See section A of Figure 15-5.

---

## Use during execution

During program execution, when the `JSL` instruction in the original load segment is encountered, the following sequence of events takes place:

1. Control transfers to the proper Jump Table entry.
2. The `JSL` in the entry transfers control to the System Loader's Jump Table Load function.
3. The Jump Table Load function gets the load-file number, load-segment number, and load-segment offset of the dynamic segment from the Jump Table entry. Then it gets the file pathname of the dynamic segment from the Pathname Table.
4. The System Loader loads the dynamic segment into memory.
5. The loader changes the dynamic segment's entry in the Jump Table to its *loaded state*. The loaded state is identical to the unloaded state, except that the `JSL` to the Jump Table Load function is replaced by a `JML` (unconditional Jump Long) to the external reference itself. Figure 15-4 shows the format for the loaded state.



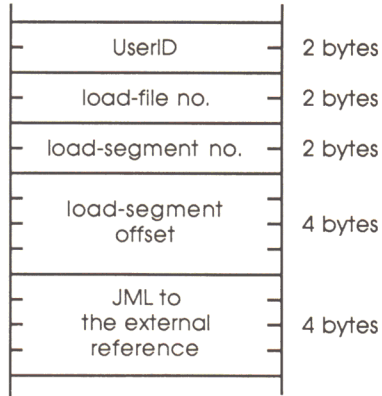

**Figure 15-4**  
Jump Table entry (loaded state)

- The loader transfers control to the dynamic segment. When the new segment has finished its task (typically it is a subroutine and exits with an `RTL`, Return from Subroutine Long), control returns to the statement following the original `JSL` instruction. See section B of Figure 15-5.

---

### Jump Table diagram

Figure 15-5 is a simplified diagram of how the Jump Table works. It follows the creation, loading, and use of a single Jump Table entry, needed to resolve a single instruction in load segment *n*. The instruction is a `JSL` to a subroutine named *routine* in dynamic segment *a*.

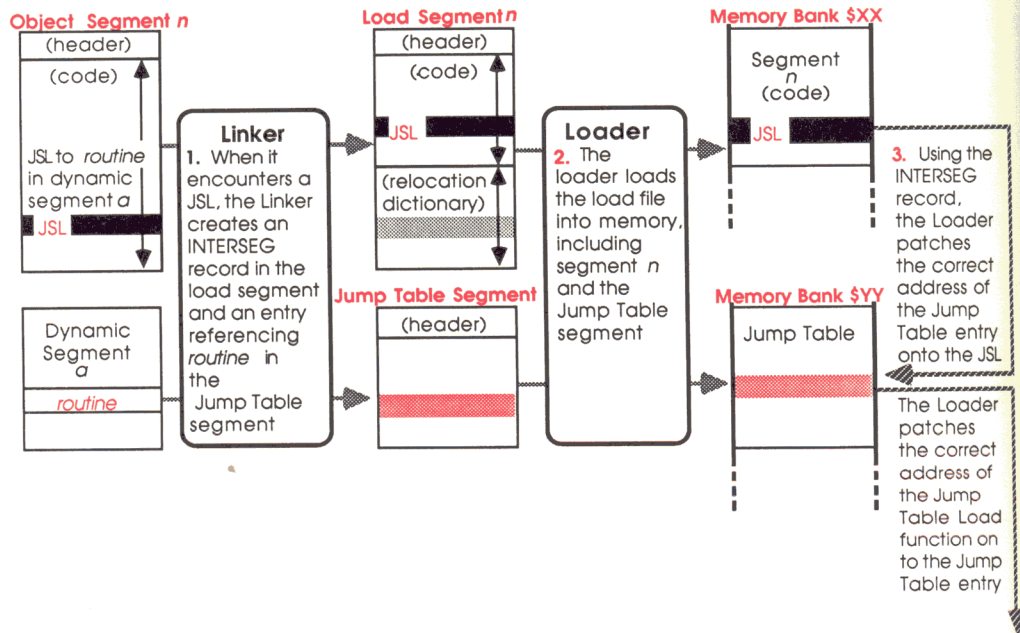

**Figure 15-5A**  
How the Jump Table works

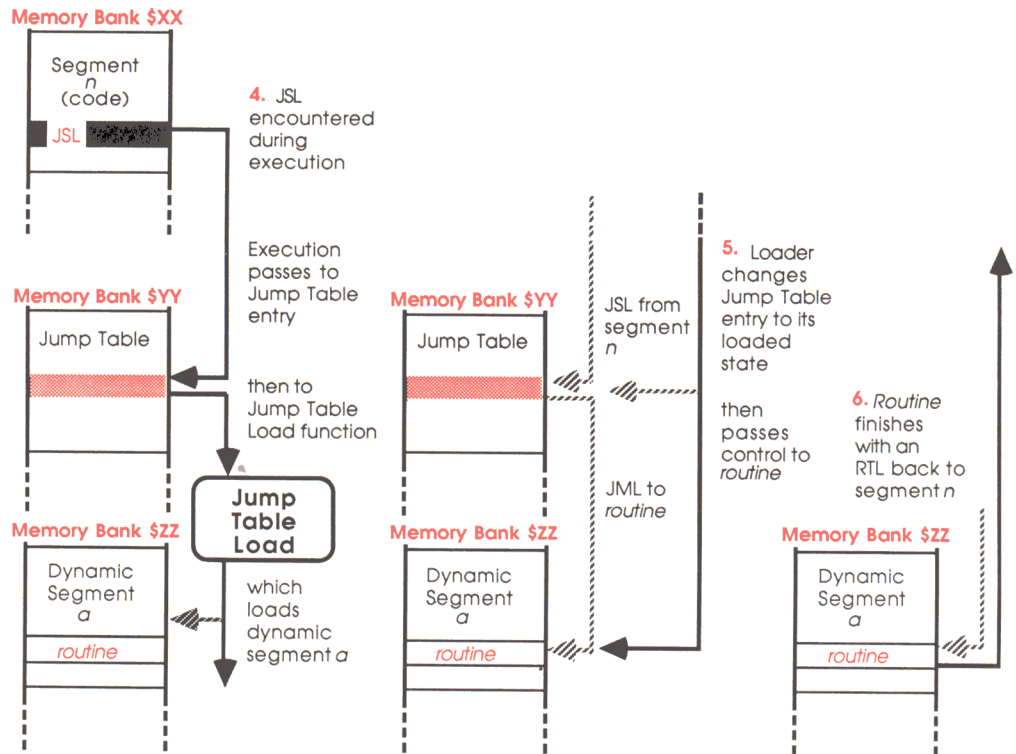

**Figure 15-5B**  
How the Jump Table works (continued)

## Pathname Table

The Pathname Table provides a cross-reference between file numbers and file pathnames, to help the System Loader find the load segments that must be loaded dynamically. The Pathname Table is a linked list of individual pathname entries; it starts with an entry for the pathname of the initial load file, and includes any entries from segments of kind \$04 (Pathname segments) that the loader encounters during the load. Also, if run-time library files are referenced during program execution, their own pathname segments are linked to the original one.

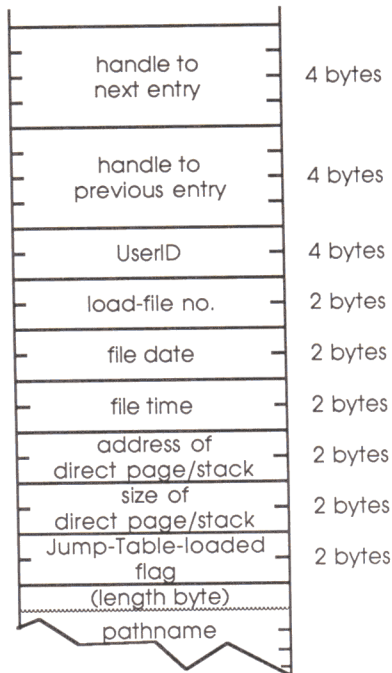

**Figure 15-6**  
Pathname Table entry

A load file's Pathname *segment* (KIND = \$04) is constructed by the linker and contains one entry for each run-time library file referenced by the file. Each entry consists of a load-file number, file date and time, and a pathname. The exact format for Pathname-segment entries is given in *Apple IIGS Programmer's Workshop Reference*.

The Pathname *Table* is constructed in memory by the loader; its entries are identical to Pathname segment entries, except that each also contains two link handles, a User ID field, and direct-page/stack information. Figure 15-6 shows the format of a Pathname Table entry.

The fields have the following meanings:

**Handle to next entry:** the memory handle of the next entry in the Pathname Table. For the last entry, the value of the handle is 0.

**Handle to previous entry:** the memory handle of the previous entry in the Pathname Table. For the first entry, the value of the handle is 0.

**User ID:** the ID associated with this entry. Generally, each load file has a unique User ID, and a single entry in the Pathname Table. Each new run-time library encountered during execution is assigned the application's User ID.

**File number:** the number assigned to a specific load file by the linker. File number 1 is reserved for the initial load file.

**File date:** the date on which the file was last modified.

**File time:** the time at which the file was last modified.

The *file date* and *file time* are ProDOS 16 directory items retrieved by the linker during linking. They are included in the Pathname Table as an identity check on run-time library files (they are ignored for other file types). To ensure that the run-time library file used at program execution is the same one originally linked by the linker, the System Loader compares these values to the directory entries of the run-time library file to be loaded. If they do not match, the System Loader will not load the file.

**Direct-page/stack address:** the starting address of the buffer allocated (at initial load) for the file's direct page (zero page) and stack.

**Direct-page/stack size:** the size (in bytes) of the buffer allocated for the file's direct page and stack.

The direct-page/stack address and size fields are in the Pathname Table to allow the Restart function to more quickly resurrect a dormant application (see “Restart” and “User Shutdown” in Chapter 17). These two fields are ignored for run-time library files.

**Jump-Table-loaded flag:** a flag that indicates whether the load file’s Jump Table segment has been loaded. Its value is always TRUE (1) for initial load files; its initial value is FALSE (0) for runtime libraries.

**File pathname:** the full or partial pathname of this entry. Partial pathnames with the following two prefix numbers are stored in the table unchanged (unexpanded):

1/ = the current application’s subdirectory

2/ = system library subdirectory (initially /V/SYSTEM/LIBS, where /V/ is the boot volume name)

The System Loader expands all other partial pathnames before storing them in the Pathname Table.

The pathname is a *Pascal string*, meaning that it consists of a length byte (of value *n*) followed by an ASCII string (*n* bytes long) that is the pathname itself.

---

---

## Mark List

The Mark List is a table constructed by the System Loader to keep track of where, within a load file, each segment’s relocation dictionary is located. The Mark List speeds relocation because, once a code segment is loaded, the loader needn’t search through it again to find the relocation dictionary—the Mark List allows it to go directly to the location of the segment’s relocation dictionary.

Figure 15-7 shows the format of the Mark List.



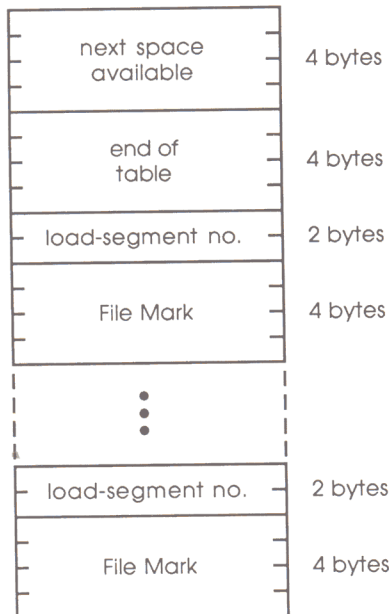

**Figure 15-7**  
Mark List format

**The fields have the following meanings:**

**Next available space:** The relative offset (in bytes from the beginning of the Mark List) to the next wempty space in the Mark List.

**end of table:** The relative offset to the end of the Mark List—in other words, its size in bytes.

**load-segment number:** The number of the load segment whose relocation dictionary is specified in the following field.

**File Mark:** The relative offset (in bytes from the beginning of the load file) to the relocation dictionary of the segment specified in the preceding field. *File Mark* in this table has the same meaning as *Mark*, or *current file position*, in ProDOS 16 (see Chapter 2).



## Chapter 16



# Programming With the System Loader

This chapter discusses how you can use the capabilities of the System Loader at several different levels, depending on the complexity of the programs you wish to write. It also gives requirements for designing controlling programs (shells)—programs that control the loading and execution of other programs.

Programming suggestions for ProDOS 16 are in Chapter 6 of this manual. More general information on how to program for the Apple IIGS is available in *Programmer's Introduction to the Apple IIGS*. For language-specific programming instructions, consult the appropriate language manual in the Apple IIGS Programmer's Workshop (see "Apple IIGS Programmer's Workshop" in Chapter 6).

---

---

## Static programs

The functioning of the System Loader is completely transparent to simple applications. Any program that is loaded into memory in its entirety at the beginning of execution, and which does not call any other programs or routines that must be loaded during run time, need not know anything about the System Loader. If such a static program is in proper object module format, it will be automatically loaded, relocated, and executed whenever it is called.

---

---

## Programming with dynamic segments

You may write Apple IIGS programs that use memory more efficiently than the simple application described above. If your program is divided into static and dynamic segments, only the static segments are loaded when the program is started up. Dynamic segments are loaded only as needed during execution, and the memory they occupy is available again when they are no longer needed.

Dynamic loading also is transparent to the typical application; no System Loader commands are necessary to invoke it. If you segment your program as you write the source code, and if you define the proper segments as dynamic and static when the object code is linked, the loading and execution of dynamic segments will be completely automatic.

Because segments are specified as static or dynamic at link time, you may experiment with several configurations of a single program after it has been assembled. For example, you might first run the program as a single static segment, then run several different static-dynamic combinations to see which gives the best performance for the amount of memory required. In this way the same program could be tailored to different machines with different memory configurations.

In general, the least-used parts of a program are the best candidates for dynamic segments, since loading and executing a dynamic segment takes longer than executing a static segment. Furthermore, making a large, seldom-used segment dynamic might make the *initial* load of a program faster, since the static part of the load file will be smaller.

Dynamic segments can be used as *overlays* (segments with the same fixed starting address that successively occupy the same memory area), but this structure is not recommended for the Apple IIGS. If all segments are instead relocatable, the Memory Manager has more flexibility in finding the best place for each allocated segment, whether or not it happens to be a space formerly occupied by another segment of the same program.

---

---

## Programming with run-time libraries

❖ *Note:* Although the System Loader supports run-time libraries, initial releases of other Apple IIGS system software may not. This section discusses how to program for run-time libraries when full support for them becomes available.

A run-time library is a load file. Like other libraries or subroutine files, it contains general routines that may be referenced by a program. As with other libraries, references to it are resolved by the linker.

Unlike other libraries, however, its segments are not physically *appended* to the program that references it; instead, the linker creates a reference to it in the program's load file. The run-time library remains on disk (or in memory) as an independent load file; when one of its segments is referenced during program execution, the segment is then loaded and executed dynamically.

As with dynamic segments, loading of run-time library segments is transparent to the typical application. No System Loader commands are necessary to invoke it; as far as the loader is concerned, the run-time library is just another load file with dynamic segments.

The most useful difference between run-time library segments and other dynamic segments is that they may be *shared* among programs. Routines for drawing or calculating, dialog boxes or graphic images, or any other segments that might be of use to more than one program can be put into run-time libraries. And, being dynamic, they help keep the initial load file small.

---

**Important**

In using both run-time libraries and other dynamic segments, make sure that the volumes containing all needed segments and libraries are on line at run time. A fatal error occurs if the System Loader cannot find a dynamic segment it needs to load.

---

---

---

## User control of segment loading

To make the greatest use of the System Loader, programs may make loader calls directly. For most applications this is not necessary, but for programs with specialized needs the System Loader offers this capability.

Your application can manually load other segments using the Load Segment By Number and Load Segment By Name calls. Load Segment By Number requires the application to know the load file number and segment number of the segment to load; Load Segment By Name uses the load file pathname and segment name of the desired segment. Both require User ID as an input; the User ID for each segment and each pathname are available from the Memory Segment Table and Pathname Table, respectively. Other segment information available through the Get Load Segment Info call.



One advantage of manually loading a dynamic segment is that it can be referenced in a more direct manner. Automatically-loaded dynamic segments can be referenced only through a JSL to the Jump Table; however, if the segment is data such as a table of values, you may wish to simply access those values rather than pass execution to the segment. By manually loading the segment, locking it, and dereferencing its memory handle (obtaining a pointer to the start of the segment), you may then directly reference any location in the table. Of course, since the loader does not resolve any symbolic references in the manually loaded segment, the application must know its exact structure.

A program is responsible for managing the segments it loads. That is, it must unload them (using Unload Segment By Number) or make them purgeable and unlocked (through Memory Manager calls) when they are no longer needed.

---

---

## Designing a controlling program

A program may cause the loading of another program in one of two ways:

- The program can make a ProDOS 16 QUIT call. ProDOS 16 and the System Loader remove the quitting program from memory, then load and execute the specified new program.
- The program can call the System Loader directly. The loader loads the specified new program without unloading the original program, then hands control back to the original program.

A controlling program is an application that loads and executes other programs using the second method. It uses powerful System Loader calls that are normally reserved for use by ProDOS 16. Certain types of finders, switchers and shells may be controlling programs; if you are writing such a program you should follow the conventions given here.

An application needs to be a controlling program only if it must *remain* in memory after it calls another program. If it is necessary only that control *return* to the original program after the called program quits, the ProDOS 16 QUIT call is sufficient for that. For example, a finder, which always returns after an application that it calls quits, does not have to be a controlling program; it is not in memory while the application is running. On the other hand, the Apple IIGS Programmer's Workshop Shell, which has functions needed by the subprograms that it calls, *is* a controlling program; it remains active in memory while its subprograms execute.

❖ *Note:* Subprograms are file type \$B5, called **shell applications**. They too must follow certain conventions. See "Object Module Format" in *Apple IIGS Programmer's Workshop Reference*, and *Programmer's Introduction to the Apple IIGS*.

If you write a controlling program, please follow these guidelines:

1. The controlling program should request a User ID for the subprogram, either directly from the User ID Manager or indirectly, by calling the System Loader's Initial Load function with an input User ID (MainID) of zero. The controlling program should then pass the returned User ID to the subprogram in the accumulator.
  2. Use the System Loader's Initial Load function to first load any subprogram. The function returns the subprogram's starting address and User ID to your controlling program; the controlling program can then decide when and where to pass control to the subprogram.
  3. When your controlling program passes execution to the subprogram, it may also pass parameters and an identifier string. The pointer to the buffer containing that information should be placed in the X (high-order word) and Y (low-order word) registers. The buffer should contain an 8-character shell identifier string, followed by a null-terminated string consisting of the complete input line or command line through which the subprogram was called.
- ❖ *Note:* ProDOS 16 does not pass an identifier string or command line when it launches a shell application. It places zeros in the X and Y registers.

4. Your controlling program is responsible for establishing the appropriate input and output vectors for its subprograms. For example, when ProDOS 16 launches a \$B5 file, it sets the global I/O hooks to point to the firmware Pascal drivers for 80-column screen and keyboard. The identifier string your controlling program passes to the subprogram allows it to check to make sure it is running in the proper I/O environment (that is, under your controlling program and not another).
5. The controlling program should observe the ProDOS 16 conventions for register initialization and direct-page/stack allocation. See Chapter 6.
6. If you want your controlling program to support shell applications that terminate with a ProDOS 16 QUIT call, the controlling program must intercept all ProDOS 16 calls. That way when a subprogram quits, the controlling program, rather than ProDOS 16, regains control.
7. When the shell application exits back to the controlling program, it leaves an error code in the accumulator. Two values are reserved: \$0000 means no error, and \$FFFF means a non-specific shell-application error. Your controlling program and subprograms may define any other errors as needed.
8. Your controlling program is totally responsible for the subprogram's disposition. When the subprogram is finished, the controlling program must remove it from memory and release all resources associated with its User ID. The best way to do this is to call the System Loader's User Shutdown function.
9. If the subprogram *itself* manually loads other programs, then it is also a controlling program and must observe all the conventions listed here. In particular, it must be certain to dispose of all memory resources associated with the subprogram that *it* loaded, before itself quitting and passing control back to the original controlling program.

The practice of using shell applications as controlling programs is discouraged.

---

## Shutting down and restarting applications

Through alternate use of the User Shutdown and Restart functions, a controlling program can rapidly switch execution among several applications. If none of an application's static segments have been removed from memory since shutdown, Restart brings the application back rapidly because disk access is not required.

However, only software that is **restartable** can be restarted in this way. Restartable software reinitializes its variables every time it gains control; it makes no assumptions about the state of the machine when it starts up. If a subprogram exits with a `QUIT` call, it specifies whether it is restartable or not; otherwise, the controlling program is responsible for deciding whether a program qualifies as restartable.

---



---

## Summary: loader calls categorized

The following table categorizes System Loader calls by the types of programs that make them. Most applications, whether their segments are static or dynamic, and whether or not they use runtime libraries, need make none of these calls. Applications that load dynamic segments manually may call any of the *user-callable* functions. Controlling programs and ProDOS 16 call the *system-wide* functions. Only the System Loader itself may call the *internal* functions. Functions not listed in Table 16-1 either do nothing or are executed only at system startup.

**Table 16-1**  
System Loader functions categorized by caller

User-Callable	System-Wide	Internal
Loader Version	Initial Load	Jump Table Load
Loader Status	Restart	Cleanup
Load Segment By Number	Get User ID	
Unload Segment By Number	Get Pathname	
Load Segment By Name	User Shutdown	
Unload Segment		
Get Load Segment Info		



## Chapter 17



# System Loader Calls



---

---

## Introduction

This chapter explains how System Loader functions are called, and describes the following calls:

Number	Function	Purpose
\$01	Loader Initialization	(executed at system startup)
\$02	Loader Startup	(no function)
\$03	Loader Shutdown	(no function)
\$04	Loader Version	returns System Loader version
\$05	Loader Reset	(no function)
\$06	Loader Status	returns initialization status
\$09	Initial Load	loads an application
\$0A	Restart	restarts a dormant application
\$0B	Load Segment By Number	loads a single segment
\$0C	Unload Segment By Number	unloads a single segment
\$0D	Load Segment By Name	loads a single segment
\$0E	Unload Segment	unloads a single segment
\$0F	Get Load Segment Info	returns a segment's handle
\$10	Get User ID	returns User ID for a pathname
\$11	Get Pathname	returns pathname for a User ID
\$12	User Shutdown	makes an application dormant
--	Jump Table Load	loads a dynamic segment
--	Cleanup	frees memory space

---

## How calls are made

The System Loader is an Apple IIGS tool set (tool number 17, or hexadecimal \$11). You call its functions using either macro calls (not described here) or the standard Apple IIGS tool calling sequence, as follows:

1. Push any required space for returned results onto the stack.
2. Push each input value onto the stack, in the proper order.
3. Execute the following call block:

```
LDX    #$11+FuncNum|8
JSL    Dispatcher
```

where

- \* **#\$11** is the System Loader tool set number
- FuncNum** is the number of the function being called (18 means "shift left by 8 bits".)
- Dispatcher** is the address of the Tool Dispatcher (\$E1 0000).

It is the responsibility of the caller (usually a controlling program) to prepare the stack for each function it calls, and to pull any results off the stack. Error status is returned in the accumulator (A register); furthermore, the carry bit is set (1) if the call is unsuccessful, and cleared (0) if the call is successful.

The Jump Table Load function does not use the above calling sequence, and cannot be called directly by an application. It is called indirectly, through a call to a Jump Table entry. The absolute address of the function is patched into the Jump Table by the System Loader at load time.

---

## Parameter types

There are four types of parameters passed in the stack: values, results, pointers, and handles. Each is either an *input to* or an *output from* the loader function being called.

- A **value** is a numerical quantity, either 2 bytes (word; see Table 3-1) or 4 bytes (long word) in length, that the caller passes to the System Loader. It is an input parameter.
- A **result** is a numerical quantity, either 2 bytes (word) or 4 bytes (long word) in length, that the System Loader passes back to the caller. It is an output parameter.

- A **pointer** is the address of a location containing data, code, or buffer space in which the System Loader can receive or place data. A pointer may be 2 bytes (word) or 4 bytes (long word) in length. The pointer itself, and the data it points to, may be either input or output.
- A **handle** is a special type of pointer: it is a pointer to a pointer. It is the 4-byte address of a location that *itself* contains the address of a location containing data, code, or buffer space. In System Loader calls, a handle is always an output.

---

## Format for System Loader call descriptions

The following sections describe the System Loader calls in detail. Each description contains these elements:

- the full name of the call
- a brief description of what function it performs
- the call's function number
- the call's assembly-language macro name (use it if you make macro calls)
- the call's parameter list (input and output)
- the stack configuration both before and after making the call
- a list of possible error codes
- the sequence of events the call invokes (if the brief description is not complete enough)

**Parameter list note:** In the parameter lists, *input* parameters are listed in the order in which they are pushed *onto* the stack; *output* parameters are listed in the order in which they are pulled *from* the stack. Check the stack diagrams if you are uncertain of the proper order in which to push any of the parameters.

**Stack diagram note:** Unlike other memory tables in this manual, the stack diagrams are organized in units of *words*—that is, each tick mark represents *two bytes* of stack space.

---

---

## Loader Initialization (\$01)

This routine initializes the System Loader; it is called by the system software at boot time. Loader Initialization clears all loader tables and sets the initial state of the system, making no assumptions about the current or previous state of the machine. The System Loader's global variables (see Appendix D) are defined at this time.

The Initialization routine is required for all Apple IIGS tool sets.

**Function Number:** \$01

**Macro Name:** LoaderInit

---

### Parameters

(none)

---

### Possible errors

(none)

---

---

## Loader Startup (\$02)

The Startup routine is required for all Apple IIGS tool sets. For the System Loader, this function does nothing and need never be called.

**Function Number:** \$02

**Macro Name:** LoaderStartup

---

### Parameters

(none)

---

### Possible errors

(none)



---

---

## Loader Shutdown (\$03)

The Shutdown routine is required for all Apple IIGS tool sets. For the System Loader, this function does nothing and need never be called.

**Function Number:** \$03

**Macro Name:** LoaderShutdown

---

### Parameters

(none)

---

### Possible errors

(none)

---

---

## Loader Version (\$04)

The Loader Version function returns the version number of the System Loader currently in use. The version number has this format:

	Byte 1								Byte 0							
Bit:	15	14	13	12	11	10	9	8	7	6	5	4	3	2	1	0
Value:	<b>B</b> Major Release No.								Minor Release No.							

where

- Byte 0 is the minor release number (= 0 for System Loader version 1.0)
- Byte 1 is the major release number (= 1 for System Loader version 1.0)
- B (the most significant bit of byte 1) = 0 for final releases  
= 1 for all prototype releases

The Version routine is required for all Apple IIGS tool sets.

**Function Number:** \$04

**Macro Name:** LoaderVersion

---

## Parameters

	Name	Size and Type
<b>Input</b>	(none)	
<b>Output</b>	Loader version	word result (2 bytes)

### Stack Before Call:

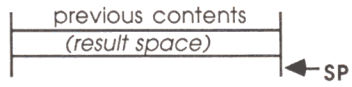

### Stack After Call:

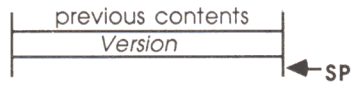

---

### Possible errors

(none)

---

---

## Loader Reset (\$05)

The Reset routine is required for all Apple IIGS tool sets. For the System Loader, this function does nothing and need never be called.

**Function Number:** \$05

**Macro Name:** LoaderReset

---

### Parameters

(none)

---

### Possible errors

(none)

---

---

## Loader Status (\$06)

This routine returns the current status (initialized or uninitialized) of the System Loader. A nonzero result means TRUE (initialized); a zero result means FALSE (uninitialized). A result of TRUE is always returned by this call because the System Loader is always in the initialized state.

The Status routine is required for all Apple IIGS tool sets.

**Function Number:** \$06

**Macro Name:** LoaderStatus

---

### Parameters

	Name	Size and Type
<b>Input</b>	(none)	
<b>Output</b>	status	word result (2 bytes)

#### Stack Before Call:

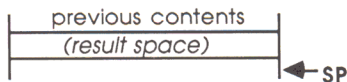

#### Stack After Call:

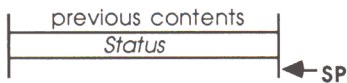

---

### Possible errors

(none)



---

---

## Initial Load (\$09)

This function is called by a controlling program (such as a shell or a switcher) to ask the System Loader to perform an initial load of a program.

**Function Number:** \$09

**Macro Name:** InitialLoad

---

### Parameters

	Name	Size and Type
<b>Input</b>	User ID	word value (2 bytes)
	address of load-file pathname	long word pointer (4 bytes)
	special-memory flag	word value (2 bytes)
<b>Output</b>	User ID	word result (2 bytes)
	starting address	long word pointer (4 bytes)
	address of direct-page/ stack buffer	word pointer (2 bytes)
	size of direct-page/ stack buffer	word result (2 bytes)

#### Stack Before Call:

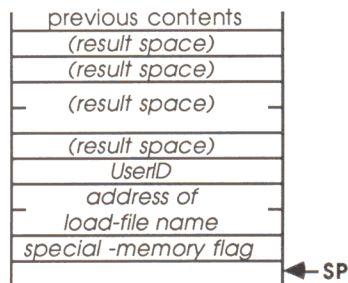

### Stack After Call:

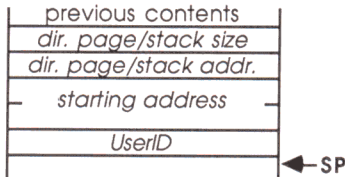

---

### Possible errors

\$1104	File is not a load file
\$1105	System Loader is busy
\$1109	SegNum out of sequence
\$110A	Illegal load record found
\$110B	Load segment is foreign
\$00xx	ProDOS 16 error
\$02xx	Memory Manager error

---

### Sequence of events

When the Initial Load function is called, the following sequence of events occurs.

1. The function checks the `TypeID` and `MainID` fields of the specified User ID.
  - a. If both fields are nonzero, the System Loader uses it to allocate space for the segments to be loaded.
  - b. If the `TypeID` field is zero, the System Loader obtains a new User ID from the User ID Manager, to assign to all segments of that file. The new `TypeID` is given the value 1, meaning that the new file is classified as an application.
  - c. If only the `MainID` field is zero, the System Loader obtains a new User ID from the User ID Manager, using the supplied `TypeID` and `AuxID`.

The User ID Manager (described in *Apple IIGS Toolbox Reference*) guarantees that User ID's are unique to each application, tool, desk accessory, and so forth. See Appendix D of this manual for a brief description of the User ID format and the `TypeID` field.

2. The function checks the value of the special-memory flag. If it is TRUE (nonzero), the System Loader will not load any *static* segments into special memory (banks \$00 and \$01—see Chapter 3). The special-memory flag does not affect the load addresses of dynamic segments.
3. The function calls ProDOS 16 to open the specified (by pathname) load file. If any ProDOS 16 error occurs, or if the file is not a load file (type \$B3-\$BE), the System Loader returns the appropriate error code.
  - ❖ *Note:* If the load file is a ProDOS 8 system file (type \$FF) or a ProDOS 8 binary file (type \$06), the loader will not load it.
4. Once the load file is opened, the System Loader adds the load-file information to the Pathname Table, and calls the Load Segment By Number function for each static segment in the load file.
  - If any static segment loaded is an Initialization Segment (segment kind=\$10), the System Loader immediately transfers control to it. When the System Loader regains control, it loads the rest of the static segments without passing control to them.
  - If a direct-page/stack segment (KIND=\$12) is loaded, the System Loader returns the segment's starting address and size.
  - ❖ *Note:* The System Loader treats a direct-page/stack segment as a locked, un purgeable, static segment. The segment cannot be moved or purged as long as the application is active, but it becomes purgeable at shutdown.
  - If any of the static segments cannot be loaded, the System Loader aborts the load and returns the error from the Load Segment By Number function.
5. Once it has loaded all the static segments, the System Loader returns the starting address of the first segment (other than an initialization segment) of load file 1 to the controlling program. It then transfers execution to the controlling program. The controlling program itself is responsible for setting the stack and direct registers and for transferring control to the just-loaded program.

---

---

## Restart (\$0A)

This function is called by a controlling program (such as a shell or a switcher) to ask the System Loader to resurrect a dormant application—one that has been shut down (by the User Shutdown function), but is still in memory.

Only programs that are restartable can be successfully resurrected through this call. A restartable program always reinitializes its variables and makes no assumptions about machine state each time it executes.

To make it restartable, a program may include a **Reload segment** containing all necessary initialization information. A Reload segment is always loaded from the file at startup, even when a program is restarted.

❖ *Note:* The controlling program that makes the Restart call is responsible for making sure that the program it specifies is indeed restartable. The System Loader makes no such checks.

**Function Number:** \$0A

**Macro Name:** Restart

---

### Parameters

	Name	Size and Type
<b>Input</b>	User ID	word value (2 bytes)
<b>Output</b>	User ID	word result (2 bytes)
	starting address	long word pointer (4 bytes)
	address of direct-page/ stack buffer	word pointer (2 bytes)
	size of direct-page/ stack buffer	word result (2 bytes)

### Stack Before Call:

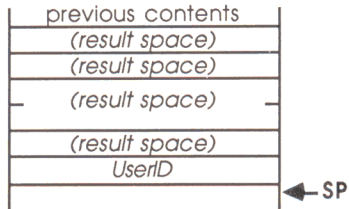

### Stack After Call:

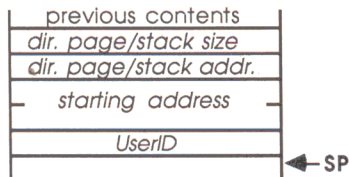

---

### Possible errors

\$1101	Application not found
\$1105	System Loader is busy
\$1108	User ID error
\$00xxx	ProDOS 16 error
\$02xxx	Memory Manager error

---

### Sequence of events

When the Restart function is called, the following sequence of events occurs.

1. An existing, nonzero User ID must be specified (the Aux ID part is ignored). If the User ID is zero, error \$1108 is returned. If the User ID is unknown to the System Loader, error \$1101 is returned.



2. The Restart function can work only if all of the specified program's static segments are still in memory. What that means is that no segments in the Memory Segment Table with the specified User ID can have been purged.
  - a. The System Loader checks the memory handle of each Memory Segment Table entry with that User ID. If none are set to NIL the segments are all in memory.
  - b. The System Loader then resurrects the application by calling the Memory Manager to make each of the application's segments un purgeable and locked.
  - c. The loader reloads any Reload segments it finds, and executes any initialization segments it finds.
  - d. The loader returns the application's complete User ID, the first segment's starting address, and the direct page and stack information (from the Pathname Table) to the caller.
3. If any of the application's static segments are no longer in memory, the function does the following:
  - a. It calls the Cleanup routine to purge all references to that User ID from the System Loader's tables and delete the User ID itself.
  - b. It calls the Initial Load function to load the application. The application receives a new User ID, which is returned to the caller.

---

---

## Load Segment By Number (\$0B)

The Load Segment By Number routine is the workhorse function of the System Loader. Other System Loader functions that load segments do so by calling this function. It loads a specific load segment into memory; the segment is specified by its load-file number, load-segment number, and User ID.

- ❖ *Note:* Applications use this function to manually load dynamic segments. An application may also use Load Segment By Number to manually load a *static* segment. However, in that case the System Loader does not patch the correct address of the newly loaded segment onto any existing references to it. Therefore the segment can be accessed only through its starting address.

**Function Number:** \$0B

**Macro Name:** LoadSegNum

---

### Parameters

	Name	Size and Type
<b>Input</b>	User ID	word value (2 bytes)
	load-file number	word value (2 bytes)
	load-segment number	word value (2 bytes)
<b>Output</b>	address of segment	long word pointer (4 bytes)

### Stack Before Call:

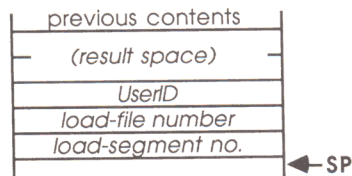

### Stack After Call:

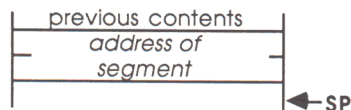

---

### Possible errors

\$1101	Segment not found
\$1102	Incompatible OMF version
\$1104	File is not a load file
\$1105	System Loader is busy
\$1107	File version error
\$1109	SegNum out of sequence
\$110A	Illegal load record found
\$110B	Load segment is foreign
\$00xx	ProDOS 16 error
\$02xx	Memory Manager error

---

### Sequence of events

When the Load Segment By Number function is called, the following sequence of events occurs.

1. First the loader checks to find out if the requested load segment is already in memory: it searches the Memory Segment Table to determine if there is an entry for the segment. If the entry exists, the loader checks the value of the memory handle to find out whether the corresponding memory block is still in memory. If so, the function terminates without returning an error. If an entry exists but the memory block has been purged, the entry is deleted.
2. If the segment is not already in memory, the System Loader looks in the Pathname Table to get the load-file pathname from the load-file number.
3. The System Loader checks the file type of the referenced file. If it is not a load file (type \$B3-\$BE), then error \$1104 is returned.

4. If the file is type \$B4 (run-time library file), the System Loader compares the file's modification date and time values to the file date and file time in the Pathname Table. If they do not match, error \$1107 is returned and the load is not performed.
5. ProDOS 16 is called to open the file. If ProDOS 16 cannot open the file, it returns an appropriate error code.
6. After ProDOS 16 successfully opens the load file, the System Loader searches the file for a load segment corresponding to the specified load-segment number. If none is found, error \$1101 is returned.

If the load segment is found, its header is checked (segment headers are described under "Object Module Format" in *Apple IIGS Programmer's Workshop Reference*). If the segment's OMF version number is incompatible with the current System Loader version, error \$1102 is returned. If the value in the header's `SEGNUM` field does not match the specified load-segment number, error \$1109 is returned. If the values in the `NUMSEX` and `NUMLEN` fields are not 0 and 4, respectively, error \$110B is returned.

7. If the load segment is found and the header is correct, a memory block of the size specified in the `LENGTH` field of the segment header is requested from the Memory Manager. If the `ORG` field in the segment header is not zero, then a memory block starting at the address specified by `ORG` is requested (`ORG` is normally zero for Apple IIGS programming; that is, most segments are relocatable). Other segment attributes are set according to values in other segment header fields—see Chapter 14.
8. If a nonzero User ID is specified, the memory block is given that User ID. If the specified User ID is zero, the memory block is given the current User ID (value of `USERID` global variable).

9. If the requested memory is not available, the Memory Manager and System Loader use these techniques to free space:
  - a. The Memory Manager unloads unneeded segments by purging their corresponding memory blocks. Blocks are purged according to their *purge levels*. For example, all level-3 blocks are purged before the first level-2 block is purged. Any dynamic segment whose memory block's purge level is zero cannot be unloaded.
  - b. If all purgeable segments have been unloaded and the Memory Manager still cannot allocate enough memory, it moves any *movable* blocks to enlarge contiguous memory areas.
  - c. If all eligible memory blocks have been purged or moved, and the Memory Manager still cannot allocate enough memory, the System Loader Cleanup routine is called to free any unused parts of the System Loader's memory. The Memory Manager then tries once more to allocate the requested memory.
  - d. If the Memory Manager is still unsuccessful, the System Loader returns the last Memory Manager error that occurred.
10. Once the Memory Manager has allocated the requested memory, the System Loader puts the load segment into memory, and processes the relocation dictionary (if any).
  - ❖ *Note:* If any records within the segment are not of a proper type (\$E2, \$E3, \$F1, \$F2, or \$00), error \$110A is returned. See Appendix D for an explanation of record types.
11. An entry for the segment is added to the Memory Segment Table.
12. The System Loader returns the starting address of the segment to the controlling program.



---

---

## Unload Segment By Number (\$0C)

This function unloads a specific load segment from memory. The segment is specified by its load-file number and load-segment number, and its User ID.

**Function Number:** \$0C

**Macro Name:** UnLoadSegNum

---

### Parameters

	Name	Size and Type
<b>Input</b>	User ID	word value (2 bytes)
	load-file number	word value (2 bytes)
	load-segment number	word value (2 bytes)
<b>Output</b>	(none)	

#### Stack Before Call:

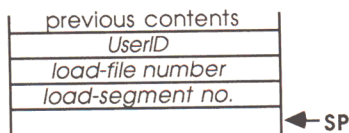

#### Stack After Call:



---

### Possible errors

\$1101	Segment not found
\$1105	System Loader is busy
\$00.xx	ProDOS 16 error
\$02.xx	Memory Manager error

---

## Sequence of events

When the Unload Segment By Number function is called, the following sequence of events occurs.

1. The System Loader searches the Memory Segment Table for the specified load-file number and load-segment number. If there is no such entry, error \$1101 is returned.
2. If the Memory Segment Table entry is found, the loader calls the Memory Manager to make *purgeable* (purge level = 3) the memory block in which the segment resides.
3. The loader changes all entries in the Jump Table that reference the unloaded segment to their unloaded states.

### Special conditions:

- If the specified User ID is zero, the current User ID (value of USERID) is assumed.
- If both the load-file number and load-segment number are nonzero, the specified segment is unloaded regardless of whether it is static or dynamic. If either input is zero, only *dynamic* segments are unloaded, as noted next.
- If the specified load-file number is zero, all dynamic segments for that User ID are unloaded.
- If the specified load-segment number is zero, all dynamic segments for the specified load file are unloaded.
- ❖ *Note:* If a *static* segment is unloaded, the application that it is part of cannot be restarted from a dormant state. See “Restart” and “User Shutdown,” in this chapter.

## Load Segment By Name (\$0D)

This function loads a *named* segment into memory. The segment is named by its load file's pathname, and its segment name (from the `SEGNAME` field in the segment header). A nonzero User ID may be specified if the loaded segment is to have a User ID different from the current User ID.

**Function Number:** \$0D

**Macro Name:** LoadSegName

### Parameters

	Name	Size and Type
<b>Input:</b>	User ID	word value (2 bytes)
	address of load-file name	long word pointer (4 bytes)
	address of load-segment name	long word pointer (4 bytes)
<b>Output:</b>	address of segment	long word pointer (4 bytes)
	User Id	word result (2 bytes)
	load-file number	word result (2 bytes)
	load-segment number	word result (2 bytes)

#### Stack Before Call:

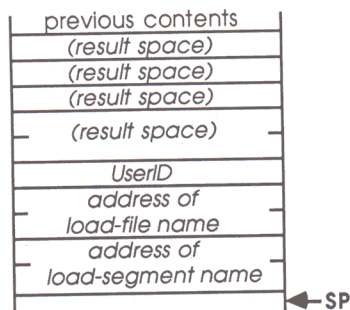

#### Stack After Call:

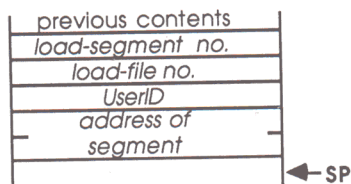

### Possible errors

\$1101	Segment not found
\$1104	File is not a load file
\$1105	System Loader is busy
\$1107	File version error
\$1109	SegNum out of sequence
\$110A	Illegal load record found
\$110B	Load segment is foreign
\$00xx	ProDOS 16 error
\$02xx	Memory Manager error

---

## Sequence of events

When the Load Segment By Name function is called, the following sequence of events occurs.

1. The System Loader gets the load-file pathname from the pointer given in the function call.
2. The System Loader checks the file type of the referenced file, from the file's disk directory entry. If it is not a load file (type \$B3-\$BE), error \$1104 is returned.
3. If it is a load file, the loader calls ProDOS 16 to open the file. If ProDOS 16 cannot open the file, it returns the appropriate error code.
4. After the load file has been successfully opened by ProDOS 16, the System Loader searches the file for a segment with the specified name. If it finds none, error \$1101 is returned.
5. If the load segment is found, the System Loader notes the segment number. It also checks the Pathname Table to see if the load file is listed. If the file is listed, the loader gets the load file number from the table; if not, it adds a new entry to the Pathname Table, assigning an unused file number to the load file. If the Jump-Table-loaded flag in the Pathname Table is FALSE, the loader loads the Jump Table segment (if any) from the load file and sets the Jump-Table-loaded flag to TRUE.
6. Now that it has both the load-file number and the segment number of the requested segment, the System Loader calls the Load Segment By Number function to load the segment. If the Load Segment By Number function returns an error, the Load Segment By Name function returns the same error. If the Load Segment By Number function is successful, the Load Segment By Name function returns the load file number, the load segment number, the User ID, and the starting address of the memory block in which the load segment was placed.

---

---

## Unload Segment (\$OE)

This function unloads the load segment containing the specified address. By using Unload Segment, an application can unload a segment without having to know its load-segment number, load-file number, name or User ID.

**Function Number:** \$OE

**Macro Name:** UnloadSeg

---

### Parameters

	Name	Size and Type
<b>Input</b>	address in segment	long word pointer (4 bytes)
<b>Output</b>	User ID	word result (2 bytes)
	load-file number	word result (2 bytes)
	load-segment number	word result (2 bytes)

#### Stack Before Call:

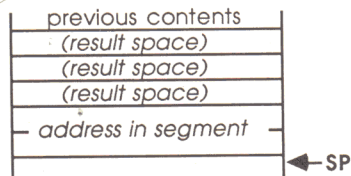

#### Stack After Call:

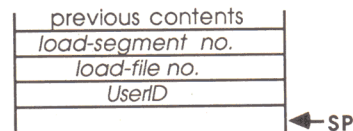



---

## Possible errors

\$1101	Segment not found
\$1105	System Loader is busy
\$00xx	ProDOS 16 error
\$02xx	Memory Manager error

---

## Sequence of events

When the Unload Segment function is called, the following sequence of events occurs.

1. The function calls the Memory Manager to identify the memory block containing the specified address. If the address is not within an allocated memory block, error \$1101 is returned.
2. If the memory block is found, the function uses the memory handle returned by the Memory Manager to find the block's User ID. It then scans the Memory Segment Table for an entry with that User ID and handle. If no such entry is found, error \$1101 is returned.
3. If the Memory Segment Table entry is found, the function does one of two things:
  - a. If the Memory Segment Table entry refers to any segment other than a Jump Table segment, the function extracts the load-file number and load-segment number from the entry.
  - b. If the Memory Segment Table entry refers to a Jump Table segment, the function extracts the load-file number and load-segment number in the *Jump Table entry* at the address specified in the function call.
4. The function then calls the Unload Segment By Number function to unload the segment.

The outputs of this function (load-file number, load-segment number, and User ID) can be used as inputs to other System Loader functions such as Load Segment By Number.

---

---

## Get Load Segment Info (\$0F)

This function returns the Memory Segment Table entry corresponding to the specified (by number) load segment.

**Function Number:** \$0F

**Macro Name:** GetLoadSegInfo

---

### Parameters

	Name	Size and Type
<b>Input</b>	User ID	word value (2 bytes)
	load-file number	word value (2 bytes)
	load-segment number	word value (2 bytes)
	address of user buffer	long word pointer (4 bytes)
<b>Output</b>	(filled user buffer)	

#### Stack Before Call:

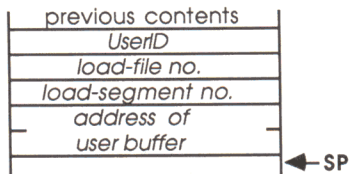

#### Stack After Call:



---

### Possible errors

\$1101	Entry not found
\$1105	System Loader is busy
\$00xx	ProDOS 16 error
\$02xx	Memory Manager error

---

## Sequence of events

When the Get Load Segment Info function is called, the following sequence of events occurs.

1. The Memory Segment Table is searched for the specified entry. If the entry is not found, error \$1101 is returned.
2. If the entry is found, the contents of the entry (except for the link pointers) are copied into the user buffer.

---

---

## Get User ID (\$10)

This function returns the User ID associated with the specified pathname. A controlling program can use this function to determine whether it can restart an application or must perform an initial load.

**Function Number:** \$10

**Macro Name:** GetUserID

---

### Parameters

	Name	Size and Type
<b>Input</b>	address of pathname	long word pointer (4 bytes)
<b>Output</b>	User ID	word result (2 bytes)

#### Stack Before Call:

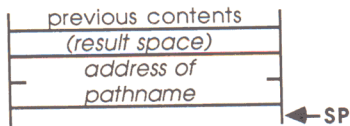

#### Stack After Call:

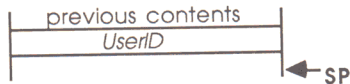

---

## Possible errors

\$1101	Entry not found
\$1105	System Loader is busy
\$00xx	ProDOS 16 error
\$02xx	Memory Manager error

---

## Sequence of events

When the Get User ID function is called, the following sequence of events occurs.

1. The System Loader searches the Pathname Table for the specified pathname. If the input pathname is a partial pathname and starts with a prefix number other than 1/ or 2/, it is expanded to a full pathname before the search.
2. If it finds a match, the loader returns the User ID from that entry in the Pathname Table.



---

---

## Get Pathname (\$11)

This function returns the pathname associated with the specified User ID. ProDOS 16 uses this call to set the application prefix (1/) for a program that is restarted from memory.

**Function Number:** \$11

**Macro Name:** GetPathname

---

### Parameters

	Name	Size and Type
<b>Input</b>	User ID	word value (2 bytes)
	File number	word value (2 bytes)
<b>Output</b>	Address of pathname	long word result (4 bytes)

#### Stack Before Call:

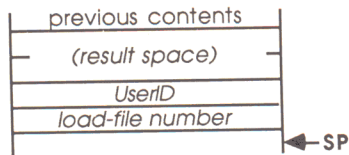

#### Stack After Call:

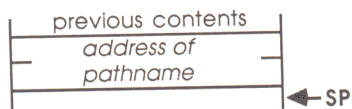

---

## Possible errors

\$1101	Entry not found
\$1105	System Loader is busy
\$00xx	ProDOS 16 error
\$02xx	Memory Manager error

---

## Sequence of events

When the Get Pathname function is called, the following sequence of events occurs.

1. The System Loader searches the Pathname Table for the specified User ID and file number.
2. If it finds a match, the loader returns the address of the pathname from that entry in the Pathname Table.

---

---

## User Shutdown (\$12)

This function is called by the controlling program to close down an application that has just terminated.

**Function Number:** \$12

**Macro Name:** UserShutdown

---

### Parameters

	Name	Size and Type
<b>Input:</b>	User ID	word value (2 bytes)
	quit flag	word value (2 bytes)
<b>Output:</b>	User ID	word result (2 bytes)

#### Stack Before Call:

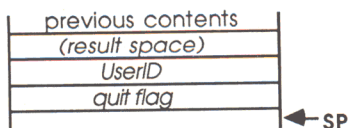

#### Stack After Call:

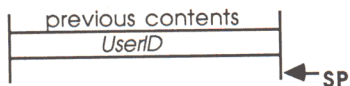

---

### Possible errors

\$1105	System Loader is busy
\$00xx	ProDOS 16 error
\$02xx	Memory Manager error

---

## Sequence of events

❖ *Note:* This function is designed to support the options provided in the ProDOS 16 QUIT function. The quit flag in this call corresponds to the *flag word* parameter in the ProDOS 16 QUIT call. Only bits 14 and 15 of the flag are significant: If bit 15 is set, the quitting program wishes control to return to it eventually; if bit 14 is set, the program is restartable. See the description of the Restart function in this chapter.

When the User Shutdown function is called, the following sequence of events occurs.

1. The System Loader checks the specified User ID. If it is zero, the loader assumes it is the current User ID (= value of USERID global variable). In any case, loader ignores (by setting to zero) all values in the AuxID field of the User ID.
2. The loader checks the value of the quit flag.
  - a. If the quit flag is zero, the Memory Manager *disposes* (permanently deallocates) all memory blocks with the specified User ID. The System Loader then calls its Cleanup routine to purge the loader's internal tables of all references to that User ID. The User ID itself is deleted so that the system no longer recognizes it.

In this case the application is completely gone. It cannot be restarted from memory or quickly reloaded.

- b. If the quit flag is \$8000 (bit 15 set to 1), the Memory Manager *purges* (temporarily deallocates) all memory blocks with the specified User ID. The System Loader's internal tables for that User ID, including the Pathname Table entry, remain intact.

In this case the application can be reloaded quickly but it cannot be restarted from memory.

- c. If the quit flag has any other value, the Memory Manager
      - *disposes* all blocks corresponding to *dynamic* segments with the specified User ID
      - makes *purgeable* all blocks corresponding to *static* segments with that User ID
      - *purges* all other blocks with that User ID

In addition, the System Loader removes all entries for that User ID from the Jump Table Directory.

The application is now in a dormant state—disconnected but not gone. It may be resurrected very quickly by the System Loader because all its static segments are still in memory. Once any of its static segments is purged by the Memory Manager, however, the program is truly lost and must be reloaded from disk if it is needed again.



---

---

## Jump Table Load

This function is called by an *unloaded* Jump Table entry in order to load a dynamic load segment. Besides the function call, the unloaded Jump Table entry includes the load-file number and load-segment number of the dynamic segment to be loaded. The Jump Table is described in Chapter 15.

**Function Number:** none

**Macro Name:** none

---

## Parameters

	Name	Size and Type
<b>Input</b>	User ID	word value (2 bytes)
	load-file number	word value (2 bytes)
	load-segment number	word value (2 bytes)
	load-segment offset	long word value (4 bytes)
<b>Output</b>	(none)	

### Stack Before Call:

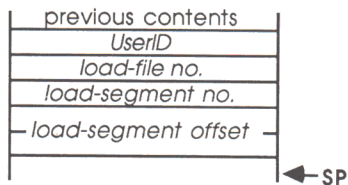

### Stack After Call:



❖ *Note:* Because this function is never called directly by a controlling program, the program need not know what parameters it requires.

---

### Possible errors

\$1101	Segment not found
\$1104	File is not a load file
\$1105	System Loader is busy
\$00xx	ProDOS 16 error
\$02xx	Memory Manager error

---

### Sequence of events

When the Jump Table Load function is called, the following sequence of events occurs.

1. The function calls the Load Segment By Number function, using the load-file number and load-segment number in the Jump Table entry. If the Load Segment By Number function returns any error, the System Loader considers it a fatal error and calls the System Failure Manager.
2. If the Load Segment By Number function successfully loads the segment, the Jump Table Load function changes the Jump Table entry to its *loaded* state: it replaces the JSL to the Jump Table Load function with a JML to the absolute address of the reference in the just-loaded segment.
3. The function transfers control to the address of the reference.

---

---

## Cleanup

This routine is used to free additional memory when needed. It scans the System Loader's internal table and removes all entries that reference purged or disposed segments.

- ❖ *Note:* Because this function is never called directly by a controlling program, the program need not know what parameters it requires.

**Function Number:** none

**Macro Name:** none

---

## Parameters

	Name	Size and Type
<b>Input</b>	User ID	word value (2 bytes)
<b>Output</b>	(none)	

### Stack Before Call:

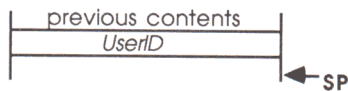

### Stack After Call:



---

## Possible errors

(none)

---

## Sequence of events

When the Cleanup routine is called, the following sequence of events occurs.

1. If the specified User ID is 0:
  - a. The System Loader scans all entries in the Memory Segment Table.
  - b. All dynamic segments for all User ID's are purged.
2. If the specified User ID is nonzero:
  - a. The System Loader scans all entries in the Memory Segment Table with that User ID.
  - b. *All* load segments (both dynamic *and* static) for that User ID are purged.
  - c. All entries in the Memory Segment Table, Jump Table directory, and Pathname Table for that User ID are deleted.



# Appendixes







## Appendix A



# ProDOS 16 File Organization

This appendix describes in detail how ProDOS 16 stores files on disks. For most applications, the operating system insulates you from this level of detail. However, you must use this information if, for example, you want to

- list the files in a directory
- copy a sparse file without increasing the file's size
- compare two sparse files

Keep in mind that ProDOS 8 and ProDOS 16 have identical file structures. The information presented here applies equally to both systems.

This appendix first explains the organization of information on volumes. Next, it shows the format and organization of volume directories, subdirectories, and the various stages of standard files. Finally it presents a set of diagrams showing the formats of individual header and entry fields.

- ❖ *Note:* In this appendix, *format* refers to the arrangement of information (such as headers, pointers and data) within a file. *Organization* refers to the manner in which a single file is stored on disk, in terms of individual 512-byte blocks.

## Organization of information on a volume

When a volume is formatted for use with ProDOS 16, its surface is partitioned into an array of tracks and sectors. In accessing a volume, ProDOS 16 requests not a track and sector, but a logical block from the device corresponding to that volume. That device's driver translates the requested block number into the proper track and sector number; the physical location of information on a volume is unimportant to ProDOS 16 and to an application that uses ProDOS 16. This appendix discusses the organization of information on a volume in terms of logical blocks, not tracks and sectors.

When the volume is formatted, information needed by ProDOS 16 is placed in specific logical blocks, starting with the first block (block 0). A loader program is placed in blocks 0 and 1 of the volume. This program enables ProDOS 16 (or ProDOS 8) to be booted from the volume. Block 2 of the volume is the **key block** (the first block) of the volume directory file; it contains descriptions of (and pointers to) all the files in the volume directory. The *volume directory* occupies a number of consecutive blocks, typically four, and is immediately followed by the **volume bit map**, which records whether each block on the volume is used or unused. The volume bit map occupies consecutive blocks, one for every 4,096 blocks, or fraction thereof, on the volume. The rest of the blocks on the disk contain *subdirectory file* information, *standard file* information, or are empty. The first blocks of a volume look something like Figure A-1.

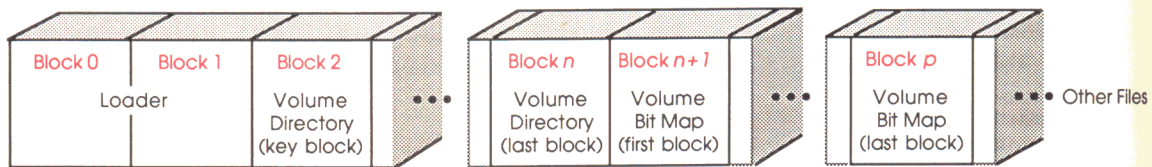

**Figure A-1**  
Block organization of a volume

The precise format of the volume directory, volume bit map, subdirectory files and standard files are explained in the following sections.

## Format and organization of directory files

The format and organization of the information contained in volume directory and subdirectory files is quite similar. Each consists of a key block followed by zero or more blocks of additional directory information. The fields in a directory's key block are:

- a pointer to the next block in the directory
- a header that describes the directory
- a number of file entries describing, and pointing to, the files in that directory
- zero or more unused bytes

The fields in subsequent (nonkey) blocks in a directory are:

- pointers to the preceding and succeeding blocks in the directory
- a number of entries describing, and pointing to, the files in that directory
- zero or more unused bytes

The format of a directory file is represented in Figure A-2.

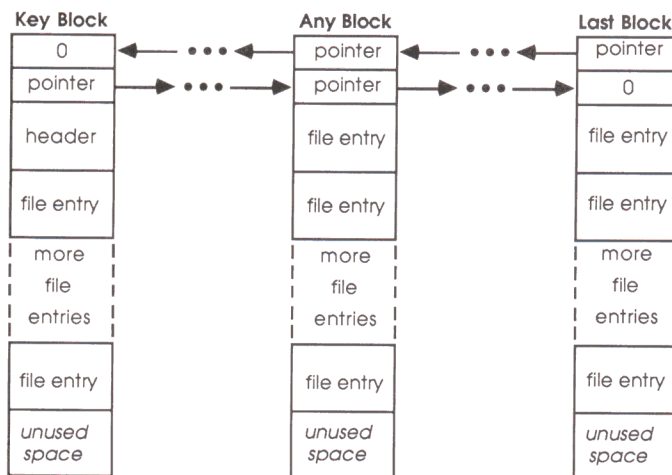

**Figure A-2**  
Directory file format and organization

The header is the same length as all other entries in a directory file. The only difference between a volume directory file and a subdirectory file is in the header format.

---

## Pointer fields

The first four bytes of each block used by a directory file contain pointers to the preceding and succeeding blocks in the directory file, respectively. Each pointer is a two-byte logical block number—low-order byte first, high-order byte second. The key block of a directory file has no preceding block; its first pointer is zero. Likewise, the last block in a directory file has no successor; its second pointer is zero.

- ❖ *Note:* The block pointers described in this appendix, which hold *disk* addresses, are two bytes long. All other ProDOS 16 pointers, which hold *memory* addresses, are four bytes long. In either case, ProDOS 16 pointers are always stored with the low-order byte first and the high-order byte last. See Chapter 3, “ProDOS 16 and Apple IIGS Memory.”

---

## Volume directory headers

Block 2 of a volume is the key block of that volume's directory file. The volume directory header is at byte position \$0004 of the key block, immediately following the block's two pointers. Thirteen fields are currently defined to be in a volume directory header: they contain all the vital information about that volume. Figure A-3 illustrates the format of a volume directory header. Following Figure A-3 is a description of each of its fields.

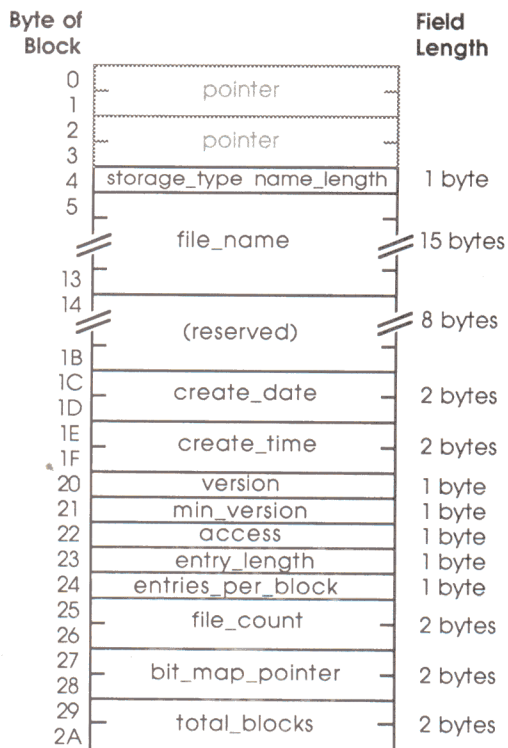

**Figure A-3**  
The volume directory header

**storage\_type and name\_length (1 byte):** Two four-bit (nibble) fields are packed into this byte. A value of \$F in the high-order nibble (*storage\_type*) identifies the current block as the key block of a volume directory file. The low-order nibble contains the length of the volume's name (see the *file\_name* field, below). The value of *name\_length* can be changed by a `CHANGE_PATH` call.

**file\_name (15 bytes):** The first *n* bytes of this field, where *n* is the value of *name\_length*, contain the volume's name. This name must conform to the file name (volume name) syntax explained in Chapter 2. The name does not begin with the slash that usually precedes volume names. This field can be changed by the `CHANGE_PATH` call.

**reserved (8 bytes):** Reserved for future expansion of the file system.



**create\_date** (2 bytes): The date on which this volume was initialized. The format of these bytes is described under "Header and Entry Fields," later in this appendix.

**create\_time** (2 bytes): The time at which this volume was initialized. The format of these bytes is described under "Header and Entry Fields," later in this appendix.

**version** (1 byte): The file system version number of ProDOS 8 or ProDOS 16 under which the file pointed to by this entry was created. This byte allows newer versions of ProDOS 16 to determine the format of the file, and adjust their interpretation processes accordingly. For ProDOS 16, `version = 0`.

❖ *Note:* Version in this sense refers to the *file system* version only. At present, all ProDOS operating systems use the same file system and therefore have the same file system version number (0). In particular, the file system version number is unrelated to the *program* version number returned by the `GET_VERSION` call.

**min\_version:** Reserved for future use. For ProDOS 16, it is 0.

**access** (1 byte): Determines whether this volume directory can be read, written, destroyed, or renamed. The format of this field is described under "Header and Entry Fields," in this appendix.

**entry\_length** (1 byte): The length in bytes of each entry in this directory. The volume directory header itself is of this length. For ProDOS 16, `entry_length = $27`.

**entries\_per\_block** (1 byte): The number of entries that are stored in each block of the directory file. For ProDOS 16, `entries_per_block = $0D`.

**file\_count** (2 bytes): The number of active file entries in this directory file. An active file is one whose `storage_type` is not 0. Figure A-5 shows the format of file entries.

**bit\_map\_pointer** (2 bytes): The block address of the first block of the volume's bit map. The bit map occupies consecutive blocks, one for every 4,096 blocks (or fraction thereof) on the volume. You can calculate the number of blocks in the bit map using the `total_blocks` field, described below.

The bit map has one bit for each block on the volume: a value of 1 means the block is free; 0 means it is in use. If the number of blocks used by all files on the volume is not the same as the number recorded in the bit map, the directory structure of the volume has been damaged.

**total\_blocks** (2 bytes): The total number of blocks on the volume.

## Subdirectory headers

The key block of every subdirectory file is pointed to by an entry in a parent directory; for example, by an entry in a volume directory (Figure A-2). A subdirectory's header begins at byte position \$0004 of the key block of that subdirectory file, immediately following the two pointers.

In format, a subdirectory header is quite similar to a volume directory header (only its last three fields are different). A subdirectory header has fourteen fields; those fields contain all the vital information about that subdirectory. Figure A-4 illustrates the format of a subdirectory header. A description of all the fields in the header follows the figure.

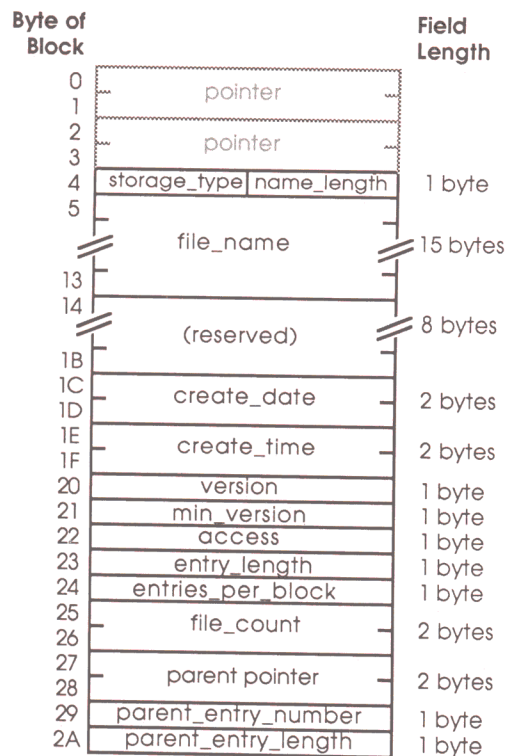

**Figure A-4**  
The subdirectory header

**storage\_type** and **name\_length** (1 byte): Two four-bit (nibble) fields are packed into this byte. A value of \$E in the high-order nibble (**storage\_type**) identifies the current block as the key block of a subdirectory file. The low-order nibble contains the length of the subdirectory's name (see the **file\_name** field, below). The value of **name\_length** can be changed by a **CHANGE\_PATH** call.

**file\_name** (15 bytes): The first *name\_length* bytes of this field contain the subdirectory's name. This name must conform to the file name syntax explained in Chapter 2. This field can be changed by the **CHANGE\_PATH** call.

**reserved** (8 bytes): Reserved for future expansion of the file system.

**create\_date** (2 bytes): The date on which this subdirectory was created. The format of these bytes is described under "Header and Entry Fields," later in this appendix.

**create\_time** (2 bytes): The time at which this subdirectory was created. The format of these bytes is described under "Header and Entry Fields," later in this appendix.

**version** (1 byte): The file system version number of ProDOS 8 or ProDOS 16 under which the file pointed to by this entry was created. This byte allows newer versions of ProDOS 16 to determine the format of the file, and adjust their interpretation processes accordingly. For ProDOS 16, **version** = 0.

❖ *Note:* Version in this sense refers to the *file system* version only. At present, all ProDOS operating systems use the same file system and therefore have the same file system version number (0). In particular, the file system version number is unrelated to the *program* version number returned by the **GET\_VERSION** call.

**min\_version** (1 byte): The minimum version number of ProDOS 8 or ProDOS 16 that can access the information in this file. This byte allows older versions of ProDOS 8 and ProDOS 16 to determine whether they can access newer files. For ProDOS 16, **min\_version** = 0.

**access** (1 byte): Determines whether this subdirectory can be read, written, destroyed, or renamed, and whether the file needs to be backed up. The format of this field is described under "Header and Entry Fields," in this appendix. A subdirectory's access byte can be changed by the **SET\_FILE\_INFO** and **CLEAR\_BACKUP\_BIT** calls.

**entry\_length** (1 byte): The length in bytes of each entry in this subdirectory. The subdirectory header itself is of this length. For ProDOS 16, `entry_length = $27`.

**entries\_per\_block** (1 byte): The number of entries that are stored in each block of the directory file. For ProDOS 16, `entries_per_block = $0D`.

**file\_count** (2 bytes): The number of active file entries in this subdirectory file. An active file is one whose `storage_type` is not 0. See "File Entries" for more information about file entries.

**parent\_pointer** (2 bytes): The block address of the directory file block that contains the entry for this subdirectory. This and all other two-byte pointers are stored low-order byte first, high-order byte second.

**parent\_entry\_number** (1 byte): The entry number for this subdirectory within the block indicated by `parent_pointer`.

**parent\_entry\_length** (1 byte): The `entry_length` for the directory that owns this subdirectory file. Note that with these last three fields you can calculate the precise position on a volume of this subdirectory's file entry. For ProDOS 16, `parent_entry_length = $27`.

---

## File entries

Immediately following the pointers in any block of a directory file are a number of entries. The first entry in the key block of a directory file is a header, all other entries are file entries. Each entry has the length specified by that directory's `entry_length` field, and each file entry contains information that describes, and points to, a single subdirectory file or standard file.

An entry in a directory file may be active or inactive, that is, it may or may not describe a file currently in the directory. If it is inactive, the first byte of the entry (`storage_type` and `name_length`) has the value zero.

The maximum number of entries, including the header, in a block of a directory is recorded in the `entries_per_block` field of that directory's header. The total number of active file entries, not including the header, is recorded in the `file_count` field of that directory's header.

Figure A-5 describes the format of a file entry.



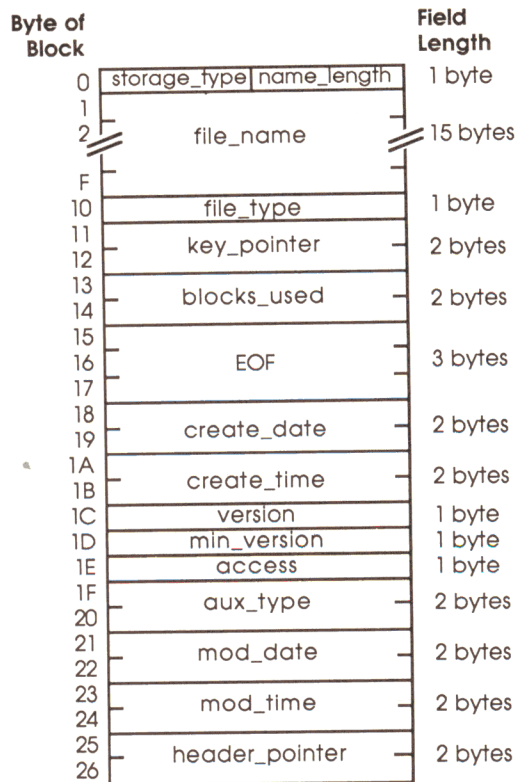

**Figure A-5**  
The file entry

**storage\_type** and **name\_length** (1 byte): Two four-bit (nibble) fields are packed into this byte. The value in the high-order nibble (**storage\_type**) specifies the type of file pointed to by this file entry:

- \$1 = Seedling file
- \$2 = Sapling file
- \$3 = Tree file
- \$4 = Pascal area
- \$D = Subdirectory

Seedling, sapling, and tree files are described under "Format and Organization of Standard Files," in this appendix. The low-order nibble contains the length of the file's name (see the `file_name` field, below). The value of `name_length` can be changed by a `CHANGE_PATH` call.



**file\_name** (15 bytes): The first *name\_length* bytes of this field contain the file's name. This name must conform to the file name syntax explained in Chapter 2. This field can be changed by the `CHANGE_PATH` call.

**file\_type** (1 byte): A descriptor of the internal format of the file. Table A-1 (at the end of this appendix) is a list of the currently defined values of this byte.

**key\_pointer** (2 bytes): The block address of:

- the master index block (if the file is a tree file)
- the index block (if the file is a sapling file)
- the data block (if the file is a seedling file)

**blocks\_used** (2 bytes): The total number of blocks actually used by the file. For a subdirectory file, this includes the blocks containing subdirectory information, but not the blocks in the files pointed to. For a standard file, this includes both informational blocks (index blocks) and data blocks. See "Format and Organization of Standard Files" in this appendix.

**EOF** (3 bytes): A three-byte integer, lowest byte first, that represents the total number of bytes readable from the file. Note that in the case of sparse files, EOF may be greater than the number of bytes actually allocated on the disk.

**create\_date** (2 bytes): The date on which the file pointed to by this entry was created. The format of these bytes is described under "Header and Entry Fields," later in this appendix.

**create\_time** (2 bytes): The time at which the file pointed to by this entry was created. The format of these bytes is described under "Header and Entry Fields," later in this appendix.

**version** (1 byte): The file system version number of ProDOS 8 or ProDOS 16 under which the file pointed to by this entry was created. This byte allows newer versions of ProDOS 16 to determine the format of the file, and adjust their interpretation processes accordingly. For ProDOS 16, `version = 0`.

❖ *Note:* Version in this sense refers to the *file system* version only. At present, all ProDOS operating systems use the same file system and therefore have the same file system version number. The file system version number is unrelated to the *program* version number returned by the `GET_VERSION` call.

**min\_version** (1 byte): The minimum version number of ProDOS 8 or ProDOS 16 that can access the information in this file. This byte allows older versions of ProDOS 8 and ProDOS 16 to determine whether they can access newer files. For ProDOS 16, `min_version = 0`.

**access** (1 byte): Determines whether this file can be read, written, destroyed, or renamed, and whether the file needs to be backed up. The format of this field is described under "Header and Entry Fields," later in this appendix. The value of this field can be changed by the `SET_FILE_INFO` and `CLEAR_BACKUP_BIT` calls. You cannot delete (destroy) a subdirectory that contains any files.

**aux\_type** (2 bytes): A general-purpose field in which an application can store additional information about the internal format of a file. For example, the ProDOS 8 BASIC system program uses this field to record the load address of a BASIC program or binary file, or the record length of a text file.

**mod\_date** (2 bytes): The date on which the last `CLOSE` operation after a `WRITE` was performed on this file. The format of these bytes is described under "Header and Entry Fields," later in this appendix. This field can be changed by the `SET_FILE_INFO` call.

**mod\_time** (2 bytes): The time at which the last `CLOSE` operation after a `WRITE` was performed on this file. The format of these bytes is described under "Header and Entry Fields," later in this appendix. This field can be changed by the `SET_FILE_INFO` call.

**header\_pointer** (2 bytes): This field is the block address of the key block of the directory that owns this file entry. This and all two-byte pointers are stored low-order byte first, high-order byte second.

---

## Reading a directory file

This section deals with the general techniques of reading from directory files, not with the specifics. The ProDOS 16 calls with which these techniques can be implemented are explained in Chapters 9 and 10.

Before you can read from a directory, you must know the directory's pathname. With the directory's pathname, you can open the directory file, and obtain a reference number (*ref\_num*) for that open file. Before you can process the entries in the directory, you must read three values from the directory header:

- length of each entry in the directory (*entry\_length*)
- number of entries in each block of the directory (*entries\_per\_block*)
- total number of files in the directory (*file\_count*).

Using the reference number to identify the file, read the first 512 bytes from the file, and into a buffer (*ThisBlock* in the following example). The buffer contains two two-byte pointers, followed by the entries; the first entry is the directory header. The three values are at positions \$1F through \$22 in the header (positions \$23 through \$26 in the buffer). In this example, these values are assigned to the variables *EntryLength*, *EntriesPerBlock*, and *FileCount*.

```
Open (DirPathname, RefNum);                               {Get reference number}
ThisBlock                                     := Read512Bytes (RefNum);           {Read a block into buffer}
EntryLength                                  := ThisBlock[$23];                 {Get directory info}
EntriesPerBlock                              := ThisBlock[$24];
FileCount                                    := ThisBlock[$25] + (256 * ThisBlock[$26]);
```

Once these values are known, an application can scan through the entries in the buffer, using a pointer (EntryPointer) to the beginning of the current entry, a counter (BlockEntries) that indicates the number of entries that have been examined in the current block, and a second counter (ActiveEntries) that indicates the number of active entries that have been processed.

An entry is active and is processed only if its first byte, the `storage_type` and `name_length`, is nonzero. All entries have been processed when `ActiveEntries` is equal to `FileCount`. If all the entries in the buffer have been processed, and `ActiveEntries` doesn't equal `FileCount`, then the next block of the directory is read into the buffer.

```

EntryPointer           := EntryLength + $04;           {Skip header entry}
BlockEntries           := $02;                       {Prepare to process entry two}
ActiveEntries          := $00;                       {No active entries found yet }

while ActiveEntries < FileCount do begin
  if ThisBlock[EntryPointer] <> $00 then begin          {Active entry}
    ProcessEntry(ThisBlock[EntryPointer]);
    ActiveEntries := ActiveEntries + $01
  end;
  if ActiveEntries < FileCount then                    {More entries to process}
    if BlockEntries = EntriesPerBlock
      then begin                                       {ThisBlock done. Do next one}
        ThisBlock           := Read512Bytes(RefNum);
        BlockEntries        := $01;
        EntryPointer         := $04
      end
    else begin                                         {Do next entry in ThisBlock}
      EntryPointer           := EntryPointer + EntryLength;
      BlockEntries           := BlockEntries + $01
    end
  end;
end;
Close(RefNum);

```

This algorithm processes entries until all expected active entries have been found. If the directory structure is damaged, and the end of the directory file is reached before the proper number of active entries has been found, the algorithm fails.



---

---

## Format and organization of standard files

Each active entry in a directory file points to the key block (the first block) of another file, which itself is either a subdirectory file or a *standard file*. As shown below, the key block of a standard file may have several types of information in it. The `storage_type` field in that file's entry must be used to determine the contents of the key block. This section explains the organization of the three stages of standard file: seedling, sapling, and tree. These are the files in which all programs and data are stored.

Every block in a standard file is either a data block or an index block. Data blocks have no predefined format—they contain whatever information the file was created to hold. Index blocks, on the other hand, have a very specific format—they consist of nothing but 2-byte pointers, giving the (disk) addresses of other blocks that make up the file. Furthermore, the low-order byte of each pointer is in the first half of the block, whereas the high-order byte of the pointer is in the second half of the block. An index block can have up to 256 pointers, so if a pointer's low-order byte is at address  $n$  in the block, its high-order byte is at address  $n+256$ .

- ❖ *Note:* Deleting a file or changing its logical size (EOF) can alter the contents of its index blocks. See “DESTROY” in Chapter 9 and “SET\_EOF” in Chapter 10.

---

## Growing a tree file

The following scenario demonstrates the *growth* of a tree file on a volume. This scenario is based on the block allocation scheme used by ProDOS 16 on a 280-block flexible disk that contains four blocks of volume directory, and one block of volume bit map. Larger capacity volumes might have more blocks in the volume bit map, but the process would be identical.

A formatted, but otherwise empty, ProDOS 16 volume is used like this:

Blocks 0-1	Loader
Blocks 2-5	Volume directory
Block 6	Volume bit map
Blocks 7-279	Unused



If you open a new file of a nondirectory type, one data block is immediately allocated to that file. An entry is placed in the volume directory, and it points to block 7, the new data block, as the key block for the file. The key block is indicated below by an arrow.

The volume now looks like this:

Blocks 0-1	Loader
Blocks 2-5	Volume directory
Block 6	Volume bit map
→ <b>Block 7</b>	<b>Data block 0</b>
Blocks 8-279	Unused

This is a **seedling file**: its key block contains up to 512 bytes of data. If you write more than 512 bytes of data to the file, the file *grows* into a **sapling file**. As soon as a second block of data becomes necessary, an index block is allocated, and it becomes the file's key block: this index block can point to up to 256 data blocks (it uses two-byte pointers). A second data block (for the data that won't fit in the first data block) is also allocated.

The volume now looks like this:

Blocks 0-1	Loader
Blocks 2-5	Volume directory
Block 6	Volume bit map
<b>Block 7</b>	<b>Data block 0</b>
→ <b>Block 8</b>	<b>Index block 0</b>
<b>Block 9</b>	<b>Data block 1</b>
Blocks 10-279	Unused

This sapling file can hold up to 256 data blocks: 128K of data. If the file becomes any bigger than this, the file *grows* again, this time into a **tree file**. A master index block is allocated, and it becomes the file's key block: the master index block can point to up to 128 index blocks, and each of these can point to up to 256 data blocks. Index block 0 becomes the first index block pointed to by the master index block. In addition, a new index block is allocated, and a new data block to which it points.

Here's a new picture of the volume:

Blocks 0-1	Loader
Blocks 2-5	Volume directory
Block 6	Volume bit map
<b>Block 7</b>	<b>Data block 0</b>
<b>Block 8</b>	<b>Index block 0</b>
<b>Blocks 9-263</b>	<b>Data blocks 1-255</b>
→ <b>Block 264</b>	<b>Master index block</b>
<b>Block 265</b>	<b>Index block 1</b>
<b>Block 266</b>	<b>Data block 256</b>
Blocks 267-279	Unused

As data is written to this file, additional data blocks and index blocks are allocated as needed, up to a maximum of 129 index blocks (one a master index block), and 32,768 data blocks, for a maximum capacity of 16,777,215 bytes of data in a file. If you did the multiplication, you probably noticed that a byte was lost somewhere. The last byte of the last block of the largest possible file cannot be used because EOF cannot exceed 16,777,216. If you are wondering how such a large file might fit on a small volume such as a flexible disk, refer to the description of sparse files in this appendix.

This scenario shows the growth of a single file on an otherwise empty volume. The process is a bit more confusing when several files are growing—or being deleted—simultaneously. However, the block allocation scheme is always the same: when a new block is needed, ProDOS 16 always allocates the first unused block in the volume bit map.

---

## Seedling files

A seedling file is a standard file that contains no more than 512 data bytes ( $\$0 \leq \text{EOF} \leq \$200$ ). This file is stored as one block on the volume, and this data block is the file's key block.

The organization of such a seedling file appears in Figure A-6.

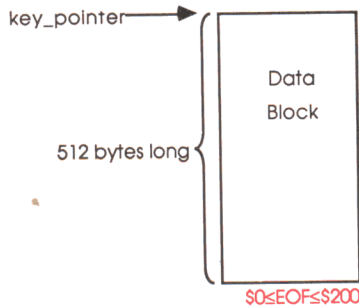

**Figure A-6**  
Format and organization of a seedling file

The file is called a seedling file because it is the smallest possible ProDOS 16 standard file; if more than 512 data bytes are written to it, it grows into a sapling file, and thence into a tree file.

The `storage_type` field of a directory entry that points to a seedling file has the value \$1.

---

## Sapling files

A sapling file is a standard file that contains more than 512 and no more than 128K bytes ( $\$200 < \text{EOF} \leq \$20000$ ). A sapling file comprises an index block and 1 to 256 data blocks. The index block contains the block addresses of the data blocks. Figure A-7 shows the organization.

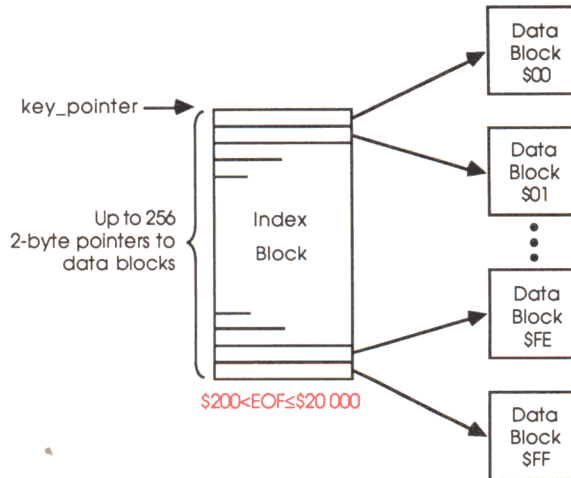

**Figure A-7**  
Format and organization of a sapling file

The key block of a sapling file is its index block. ProDOS 16 retrieves data blocks in the file by first retrieving their addresses in the index block.

The `storage_type` field of a directory entry that points to a sapling file has the value \$2.

---

## Tree files

A tree file contains more than 128K bytes, and less than 16Mb ( $\$20000 < EOF < \$1000000$ ). A tree file consists of a master index block, 1 to 128 index blocks, and 1 to 32,768 data blocks. The master index block contains the addresses of the index blocks, and each index block contains the addresses of up to 256 data blocks. The organization of a tree file is shown in Figure A-8.

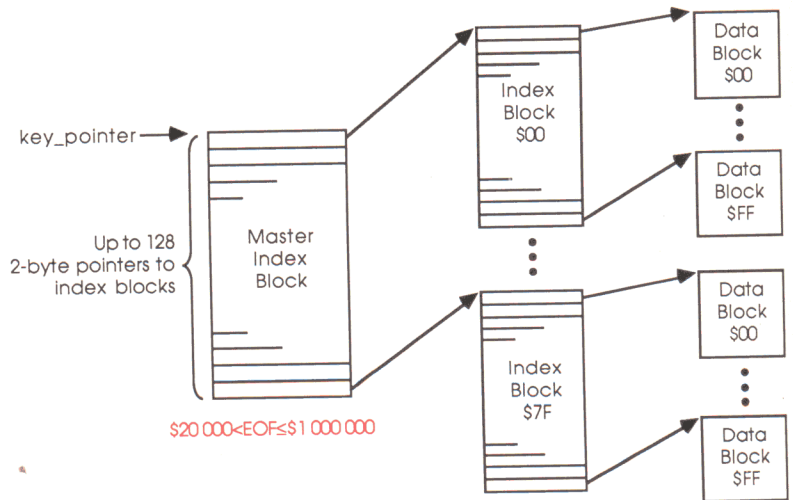

**Figure A-8**  
Format and organization of a tree file

The key block of a tree file is the master index block. By looking at the master index block, ProDOS 16 can find the addresses of all the index blocks; by looking at those blocks, it can find the addresses of all the data blocks.

The `storage_type` field of a directory entry that points to a tree file has the value \$3.

## Using standard files

An application program operates the same on all three types of standard files, although the `storage_type` in the file's entry can be used to distinguish between the three. A program rarely reads index blocks or allocates blocks on a volume: ProDOS 16 does that. The program need only be concerned with the data stored in the file, not with how they are stored.

All types of standard files are read as a sequence of bytes, numbered from 0 to (EOF-1), as explained in Chapter 2.



---

## Sparse files

A sparse file is a sapling or tree file in which the number of data bytes that can be read from the file exceeds the number of bytes physically stored in the data blocks allocated to the file. ProDOS 16 implements sparse files by allocating only those data blocks that have had data written to them, as well as the index blocks needed to point to them.

For example, you can define a file whose EOF is 16K, that uses only three blocks on the volume, and that has only four bytes of data written to it. Refer to figure A-9 during the following explanation.

1. If you create a file with an EOF of \$0, ProDOS 16 allocates only the key block (a data block) for a seedling file, and fills it with null characters (ASCII \$00).
2. If you then set the EOF and Mark to position \$0565, and write four bytes, ProDOS 16 calculates that position \$0565 is byte \$0165 ( $\$0564 - (\$0200 * 2)$ ) of the third block (block \$2) of the file. It then allocates an index block, stores the address of the current data block in position 0 of the index block, allocates another data block, stores the address of that data block in position 2 of the index block, and stores the data in bytes \$0165 through \$0168 of that data block. The EOF is now \$0569.
- 3 If you now set the EOF to \$4000 and close the file, you have a 16K sapling file that takes up three blocks of space on the volume: two data blocks and an index block (shaded in Figure A-9). You can read 16384 bytes of data from the file, but all the bytes before \$0565 and after \$0568 are nulls.

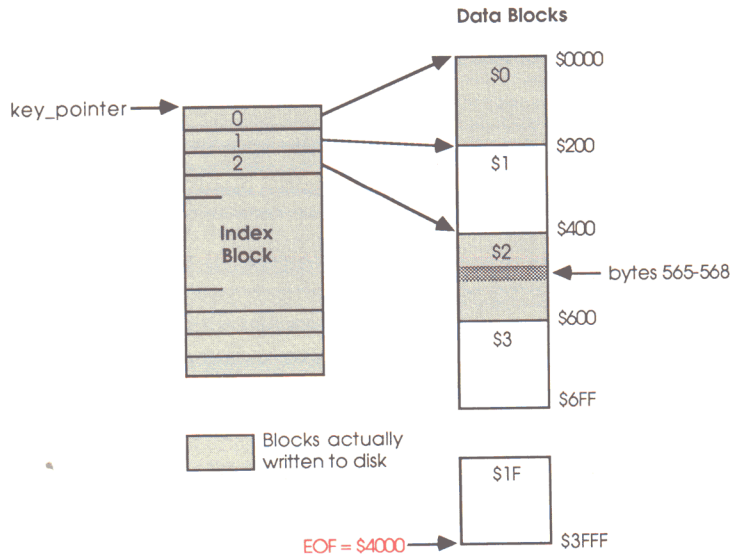

**Figure A-9**  
An example of sparse file organization

Thus ProDOS 16 allocates volume space only for those blocks in a file that actually contain data. For tree files, the situation is similar: if none of the 256 data blocks assigned to an index block in a tree file have been allocated, the index block itself is not allocated.

- ❖ *Note:* The first data block of a standard file, be it a seedling, sapling, or tree file, is always allocated. Thus there is always a data block to be read in when the file is opened.

## Locating a byte in a file

This is how to find a specific byte within a standard file:

The File Mark is a three-byte value that indicates an absolute byte position within a file. If the file is a tree file, then the high-order seven bits of the Mark determine the number (0 to 127) of the index block that points to the byte. That number is also the location of the low byte of the index block address within the master index block. The location of the high byte of the index block address is that number plus 256.

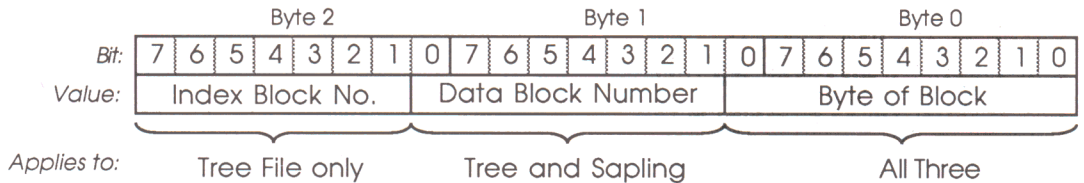

**Figure A-10**  
File Mark format

If the file is a tree file or a sapling file, then the next eight bits of the Mark determine the number (0-255) of the data block pointed to by the indicated index block. That number is also the location of the low byte of the data block address within the index block. The high byte of the index block address is found at that value plus 256.

For tree, sapling, and seedling files, the value of the low nine bits of the Mark is the location of the byte within the selected data block.

---



---

## Header and entry fields

---

### The storage type attribute

The value in the `storage_type` field, the high-order four bits of the first byte of an entry, defines the type of header (if the entry is a header) or the type of file described by the entry. Table A-1 lists the currently defined storage type values.

**Table A-1**  
Storage type values

Storage type	
\$0	indicates an inactive file entry
\$1	indicates a seedling file entry (EOF <= 256 bytes)
\$2	indicates a sapling file entry (256 < EOF <= 128K bytes)
\$3	indicates a tree file entry (128K < EOF < 16M bytes)
\$4	indicates a Pascal operating system area on a partitioned disk
\$D	indicates a subdirectory file entry
\$E	indicates a subdirectory header
\$F	indicates a volume directory header

ProDOS 16 automatically changes a seedling file to a sapling file and a sapling file to a tree file when the file's EOF grows into the range for a larger type. If a file's EOF shrinks into the range for a smaller type, ProDOS 16 changes a tree file to a sapling file and a sapling file to a seedling file.

### The creation and last-modification fields

The date and time of the creation and last modification of each file and directory is stored as two four-byte values, as shown in Figure A-11.

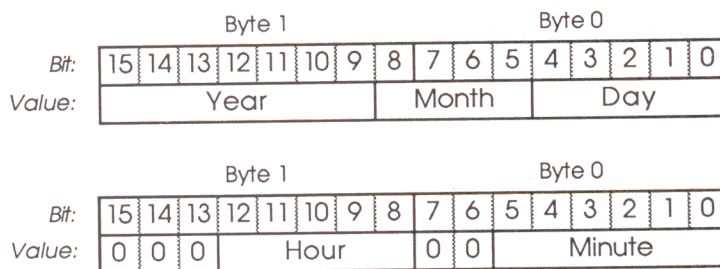

**Figure A-11**  
Date and time format

The values for the year, month, day, hour, and minute are stored as binary integers, and may be unpacked for conversion to normal integer values.

---

## The access attribute

The access attribute field, or access byte (Figure A-12), determines whether the file can be read from, written to, deleted, or renamed. It also contains a bit that can be used to indicate whether a backup copy of the file has been made since the file's last modification.

Bit:	7	6	5	4	3	2	1	0
Value:	D	RN	B	reserved	W	R		

where

D = destroy-enable bit  
RN = rename-enable bit  
B = backup-needed bit  
W = write-enable bit  
R = read-enable bit

**Figure A-12**  
Access byte format

A bit set to 1 indicates that the operation is enabled; a bit cleared to 0 indicates that the operation is disabled. The reserved bits are always 0. The most typical setting for the access byte is \$C3 (11000011).

ProDOS 16 sets bit 5, the **backup bit**, to 1 whenever the file is changed (that is, after a CREATE, RENAME, CLOSE after WRITE, or SET\_FILE\_INFO operation). This bit should be reset to 0 whenever the file is duplicated by a backup program.

❖ *Note:* Only ProDOS 16 may change bits 2-4; only backup programs should clear bit 5 (using CLEAR\_BACKUP\_BIT).



## The file type attribute

The `file_type` field in a directory entry identifies the type of file described by that entry. This field should be used by applications to guarantee file compatibility from one application to the next. The currently defined hexadecimal values of this byte are listed in Table A-2.

Table A-2 also lists the 3-character mnemonic file-type codes that should appear on catalog listings. For any file type without a specified mnemonic code, the catalog program should substitute the hexadecimal file type number.

❖ *Note:* SOS file types are included in Table A-2 because SOS and ProDOS have identical file systems.

**Table A-2**  
ProDOS file types

File type	Mnemonic Code	Description
\$00		Uncategorized file (SOS and ProDOS)
\$01	BAD	Bad block file
\$02 †	PCD	Pascal code file
\$03 †	PTX	Pascal text file
\$04	TXT	ASCII text file (SOS and ProDOS)
\$05 †	PDA	Pascal data file
\$06	BIN	General binary file (SOS and ProDOS 8)
\$07 †	FNT	Font file
\$08	FOT	Graphics screen file
\$09 †	BA3	Business BASIC program file
\$0A †	DA3	Business BASIC data file
\$0B †	WPF	Word Processor file
\$0C †	SOS	SOS system file
\$0D–\$0E †		(SOS reserved)
\$0F	DIR	Directory file (SOS and ProDOS)
\$10 †	RPD	RPS data file
\$11 †	RPI	RPS index file
\$12 †		AppleFile discard file
\$13 †		AppleFile model file
\$14 †		AppleFile report format file
\$15 †		Screen Library file
\$16–\$18 †		(SOS reserved)

**Table A-2 (continued)**  
ProDOS file types

File type	Mnemonic Code	Description
\$19	ADB	AppleWorks Data Base file
\$1A	AWP	AppleWorks Word Proc. file
\$1B	ASP	AppleWorks Spreadsheet file
\$1C-\$AF		(reserved)
\$B0	SRC	APW source file
\$B1	OBJ	APW object file
\$B2	LIB	APW library file
\$B3	S16	ProDOS 16 application program file
\$B4	RTL	APW run-time library file
\$B5	EXE	ProDOS 16 shell application file
\$B6		ProDOS 16 permanent initialization file
\$B7		ProDOS 16 temporary initialization file
\$B8		New desk accessory
\$B9		Classic desk accessory
\$BA		Tool set file
\$BB-\$BE		(reserved for ProDOS 16 load files)
\$BF		ProDOS 16 document file
\$C0-\$EE		(reserved)
\$EF	PAS	Pascal area on a partitioned disk
\$F0	CMD	ProDOS 8 CI added command file
\$F1-\$F8		ProDOS 8 user defined files 1-8
\$F9		(ProDOS 8 reserved)
\$FA	INT	Integer BASIC program file
\$FB	IVR	Integer BASIC variable file
\$FC	BAS	Applesoft program file
\$FD	VAR	Applesoft variables file
\$FE	REL	Relocatable code file (EDASM)
\$FF	SYS	ProDOS 8 system program file

†apply to SOS (Apple III) only

### The auxiliary type attribute

Some applications use an another field in a file's directory entry, the auxiliary type field (`aux_type`), to store additional information not specified by the file type. Catalog listings may display the contents of this field under the heading "Subtype."

For example, APW source files (file type \$B0) include a language-type designation in the aux\_type field. The starting address for ProDOS 8 executable binary files (file type \$06) may be in the aux\_type field. The record size for random-access text files (file type \$04) may be specified in the auxiliary type field.

ProDOS 16 and ProDOS 8 impose no restrictions (other than size) on the contents or format of the auxiliary type field. Individual applications may use those 2 bytes to store any useful information.



## Appendix B



# Apple II Operating Systems

This appendix explains the relationships between ProDOS 16 and three other operating systems developed for the Apple II family of computers (DOS, ProDOS 8, and Apple II Pascal), as well as two developed for the Apple III (SOS and Apple III Pascal).

If you have written programs for one of the other systems or are planning to write programs concurrently for ProDOS 16 and another system, this appendix may help you see what changes will be necessary to transfer your program from one system to another. If you are converting files from one system to another, this appendix may help you understand why some conversions may be more successful than others.

The first section gives a brief history. The next two sections give general comparisons of the other operating systems to ProDOS 16, in terms of file compatibility and operational similarity.

---

---

### History

---

#### DOS

DOS stands for *Disk Operating System*. It is Apple's first operating system; before DOS, the firmware **Monitor program** controlled program execution and input/output.

DOS was developed for the Apple II computer. It provided the first capability for storage and retrieval of various types of files on disk (the Disk II); the System Monitor had allowed input/output (of binary data) to cassette tape only.

The latest version of DOS is DOS 3.3. It uses a 16-sector disk format, like ProDOS 8 and ProDOS 16. Earlier versions use a 13-sector format that cannot be read by ProDOS 8 or ProDOS 16.

---

## SOS

SOS is the operating system developed for the Apple III computer. Its name is an acronym for *Sophisticated Operating System*, reflecting its increased capabilities over DOS. On the other hand, SOS requires far more memory space than either DOS or ProDOS 8 (below), which makes it impractical on computers with less than 256K of RAM.

---

## ProDOS 8

ProDOS 8 (for *Professional Disk Operating System*) was developed for the newer members of the Apple II family of computers. It requires at least 64K of RAM memory, and can run on the Apple IIe, Apple IIc, and 64K Apple II Plus.

ProDOS 8 brings some of the advanced features of SOS to the Apple II family, without requiring as much memory as SOS does. Its commands are essentially a subset of the SOS commands.

The latest version of ProDOS 8 developed specifically for the Apple IIe and IIc is ProDOS 8 (1.1.1). An even more recent version, developed for the Apple IIGS but compatible with the IIe and IIc, is ProDOS 8 (1.2).

❖ *Note:* Prior to development of ProDOS 16, ProDOS 8 was called simply *ProDOS*.



---

## ProDOS 16

ProDOS 16 is an extensive revision of ProDOS 8, developed specifically for the Apple IIGS (it will not run on other Apple II's). The 16 refers to the 16-bit internal registers in the Apple IIGS 65C816 microprocessor.

ProDOS 16 permits access to the entire 16 Mb addressable memory space of the Apple IIGS (ProDOS 8 is restricted to addressing 64K) and it has more “SOS-like” features than ProDOS 8 has. It also has some new features, not present in SOS, that ease program development.

There are two versions of ProDOS 16. Version 1.0 is a first-release system, consisting of a ProDOS 8 core surrounded by a “ProDOS 16-like” user interface. Version 2.0 is the complete implementation of the ProDOS 16 design.

---

## Pascal

The Pascal operating system for the Apple II is modified and extended from UCSD Pascal, developed at the University of California at San Diego. The latest version, written for the Apple IIe/IIc and 64K Apple II Plus, is Pascal 1.3. It also runs on an Apple IIGS.

Pascal for the Apple III is a modified version of Apple II Pascal. It uses SOS for most of its operating system functions.

---

---

## File compatibility

ProDOS 16, ProDOS 8, and SOS all use a hierarchical file system with the same format and organization. Every file on one system's disk can be read by either of the other systems. DOS and Pascal use significantly different formats.

The other systems compare to ProDOS 16 as follows:

**ProDOS 8:** ProDOS 16 and ProDOS 8 have identical file system organizations—therefore, ProDOS 16 can read all ProDOS 8 files. However, the System Loader under ProDOS 16 will not *execute* ProDOS 8 executable binary files (type \$06). Likewise, ProDOS 8 can read but will not execute file types \$B3–\$BE; those file types are specific to ProDOS 16.

**SOS:** ProDOS 16 and SOS have identical file system organizations—therefore, ProDOS 16 can read (but not execute) all SOS files.

**DOS:** DOS does not have a hierarchical file system. ProDOS 16 cannot directly read DOS files (but see “Reading DOS 3.3 and Apple II Pascal Disks,” in the following section).

**Pascal:** Apple II Pascal does not have a hierarchical file system. ProDOS 16 cannot directly read Apple II Pascal files (but see “Reading DOS 3.3 and Apple II Pascal Disks,” below).

Apple III Pascal uses the SOS file system. Therefore ProDOS 16 can read (but not execute) all Apple III Pascal files.

---

## Reading DOS 3.3 and Apple II Pascal disks

Both DOS 3.3 and ProDOS 8 140K flexible disks are formatted using the same 16-sector layout. As a consequence, the ProDOS 16 `READ_BLOCK` and `WRITE_BLOCK` calls are able to access DOS 3.3 disks too. These calls know nothing about the organization of files on either type of disk.

When using `READ_BLOCK` and `WRITE_BLOCK`, you specify a 512-byte block on the disk. When using `RWTS` (the DOS 3.3 counterpart to `READ_BLOCK` and `WRITE_BLOCK`), you specify the track and sector of a 256-byte chunk of data, as explained in the *DOS Programmer's Manual*. To use `READ_BLOCK` and `WRITE_BLOCK` to access DOS 3.3 disks, you must know what 512-byte block corresponds to the track and sector you want.

Table B-1 shows how to determine a block number from a given track and sector. First multiply the track number by 8, then add the sector offset that corresponds to the sector number. The half of the block in which the sector resides is determined by the half-of-block line (1 is the first half; 2 is the second).

**Table B-1**  
Tracks and sectors to blocks (140K disks)

---

Block number = (8*track number) + sector offset																
<b>Sector:</b>	0	1	2	3	4	5	6	7	8	9	A	B	C	D	E	F
<b>Sector offset:</b>	0	7	6	6	5	5	4	4	3	3	2	2	1	1	0	7
<b>Half of block:</b>	1	1	2	1	2	1	2	1	2	1	2	1	2	1	2	2

---

Refer to the *DOS Programmer's Manual* for a description of the file organization of DOS 3.3 disks.

---

---

## Operating system similarity

This section compares the functional similarities among the operating systems. Functional similarity between two systems implies that they perform closely related operations, but it does not mean that they have identical procedures or commands.

---

### Input/Output

ProDOS 16 can perform I/O operations on files in disk drives (block devices) only. Under ProDOS 16, therefore, the current application is responsible for knowing the protocol necessary to communicate with character devices (such as the console, printers, and communication ports).

The other systems compare to ProDOS 16 as follows:

**ProDOS 8:** Like ProDOS 16, ProDOS 8 performs I/O on block devices only.

**SOS:** SOS communicates with all devices, both character devices and block devices, by making appropriate *file* access calls (such as open, read write, close). Under SOS, writing to one device is essentially the same as writing to another.

**DOS:** DOS allows communication with one type of device only—the Disk II drive. DOS 3.3 uses a 16-sector disk format; earlier versions of DOS use a 13-sector format. 13-sector Disk II disks cannot be read directly by DOS 3.3, SOS, ProDOS 8, or ProDOS 16.

**Pascal:** Apple II and Apple III Pascal provide access to both block devices and character devices, through *File I/O*, *Block I/O*, and *Device I/O* calls to the volumes on the devices.

---

## Filing calls

SOS, ProDOS 8, and ProDOS 16 filing calls are all closely related. Most of the calls are shared by all three systems; furthermore, their numbers are identical in ProDOS 8 and SOS (ProDOS 16 calls have a completely different numbering system from either ProDOS 8 or SOS).

The other systems compare to ProDOS 16 as follows:

**ProDOS 8:** The ProDOS 8 `ON_LINE` call corresponds to the ProDOS 16 `VOLUME` call. When given a device name, `VOLUME` returns the volume name for that device. When given a unit number (derived from the slot and drive numbers), `ON_LINE` returns the volume name.

The ProDOS 8 `RENAME` call corresponds to the ProDOS 16 `CHANGE_PATH` call, except that `RENAME` can change only the *last* name in a pathname.

**SOS:** The SOS `GET_FILE_INFO` call returns the size of the file (the value of EOF). With ProDOS 16 you must first open the file and then use the `GET_EOF` call.

The SOS `VOLUME` call corresponds to the ProDOS 16 `VOLUME` call. When given a device name, `VOLUME` returns the volume name for that device.

The SOS calls `SET_MARK` and `SET_EOF` can use a displacement from the current position in the file. ProDOS 16 accepts only absolute positions in the file for these calls.

**DOS:** DOS calls distinguish between *sequential-access* and *random-access* text files. ProDOS 16 makes no such distinction, although the ProDOS 16 `READ` call in `NEWLINE` mode functions as a sequential-access read.

DOS uses `APPEND` and `POSITION` commands, roughly similar to ProDOS 16's `SET_MARK`, to set the current position in the file and to automatically extend the size of the file.

The `CLOSE` command in DOS can be given in immediate (from the keyboard) or deferred (in a program) mode. No ProDOS 16 commands can be given in immediate mode.



**Pascal:** Apple II Pascal distinguishes among *text files*, *data files*, and *code files*, each with different header formats; all ProDOS 16 files have identical header formats. The Pascal procedures REWRITE and RESET correspond to ProDOS 16's CREATE and OPEN calls. Pascal has more procedures for reading from and writing to files and devices than does ProDOS 16.

Because Apple III Pascal uses the SOS file system, its filing calls correspond directly to SOS calls.

---

## Memory management

Under ProDOS 16, neither the operating system nor the application program perform memory management; allocation of memory is the responsibility of the Memory Manager, an Apple IIGS ROM-based tool set. When an application needs space for its own use, it makes a direct request to the Memory Manager. When it makes a ProDOS 16 call that requires the allocation of memory space, ProDOS 16 makes the appropriate request to the Memory Manager. The Apple IIGS Memory Manager is similar to the SOS memory manager, except that it is more sophisticated and is not considered part of the operating system.

The other systems compare to ProDOS 16 as follows:

**ProDOS 8:** A ProDOS 8 application is responsible for its own memory management. It must find free memory, and then allocate it by marking it off in the ProDOS 8 global page's memory bit map. ProDOS 8 protects allocated areas by refusing to write to any pages that are marked on the bit map. Thus it prevents the user from destroying protected memory areas (as long as all allocated memory is properly marked off, and all data is brought into memory using ProDOS 8 calls).

**SOS:** SOS has a fairly sophisticated Memory Manager that is part of the operating system itself. An application requests memory from SOS, either by location or by the amount needed. If the request can be satisfied, SOS grants it. That portion of memory is then the sole responsibility of the requestor until it is released.

**DOS:** DOS performs no memory management. Each application under DOS is completely responsible for its own memory allocation and use.



**Pascal:** Apple II Pascal uses a simple memory management system that controls the loading and unloading of code and data segments and tracks the size of the stack and heap.

Apple III Pascal uses SOS for memory management.

---

## Interrupts

ProDOS 16 does not have any built-in interrupt-generating device drivers. Interrupt handling routines are therefore installed into ProDOS 16 separately, using the `ALLOC_INTERRUPT` call. When an interrupt occurs, ProDOS 16 polls the handling routines in succession until one of them claims the interrupt.

The other systems compare to ProDOS 16 as follows:

**ProDOS 8:** ProDOS 8 handles interrupts identically to ProDOS 16, except that it allows fewer installed handlers (4 vs. 16).

**SOS:** In SOS, any device capable of generating an interrupt must have a device driver capable of handling the interrupt; the device driver and its interrupt handler are inseparable and are considered to be part of SOS. In addition, SOS assigns a distinct interrupt priority to each device in the system.

**DOS:** DOS does not support interrupts.

**Pascal:** Apple II Pascal versions 1.2 and 1.3 support interrupts; earlier versions of Apple II Pascal do not.

Apple III Pascal uses the SOS interrupt system.



## Appendix C



# The ProDOS 16 Exerciser

The *ProDOS 16 Exerciser* is a program that lets you practice making operating system calls without writing an application. All ProDOS 16 functions execute just as they would when called from a program; therefore you can test how the calls work and, if necessary, correct any programming errors before coding your routines.

---

---

### Starting the Exerciser

First, make a copy of the Exerciser disk and put the original away in a safe place. Consult your owner's manual if you need instructions on how to copy a disk.

The Exerciser may be the startup program on the diskette provided with this manual. If so, it should execute automatically when you turn on the machine and insert the diskette. Otherwise, select it from the desktop or program launcher that comes up when you start up the system. The program's filename is EXERCISER.

The first display is the menu screen. It shows all ProDOS 16 calls by number and name, as well as a few other commands you may enter. The menu screen always returns between execution of calls or commands

---

---

## Making system calls

You make system calls from the exerciser by entering their call numbers. The number you enter is displayed at the bottom of the menu screen. You may clear the number at any time by pressing zero twice in succession.

After entering the number, press the Return key. The parameter block for the call you selected is displayed. Enter a value (or select the default provided by pressing the Return key) for each parameter; each time you press Return, the cursor moves downward one position in the parameter block. The cursor does not stop at any parameter that is a result *only* (that has no input value).

❖ *Note:* If, while you are entering parameters, you wish to correct a value, press the Escape key—it positions the cursor back at the top of the parameter block. At any other time, however, the Escape key returns you to the main menu.

Pathnames and other text strings are passed to and from ProDOS 16 in buffers referenced by pointers in the parameter blocks.

Therefore, to enter or read a pathname you must provide a buffer for ProDOS 16 to read from or write to. In most cases, the Exerciser sets up a default buffer, pointed to by a default pointer parameter (see, for example, the `CREATE` call). The contents of the location referenced by that pointer are displayed on the screen, below the parameter block. For convenience, you can directly edit the displayed string on the screen; you needn't access the memory location itself.

After you have entered all the required parameters, press the Return key once more to execute the call. If everything has gone right, the parameter list now contains results returned by ProDOS 16, and the message "\$00 call successful" appears at the bottom of the screen. If a ProDOS 16 error occurs, the proper error number and message are displayed instead. In addition, if an error occurs a small "c" should appear at the lower right corner of the screen, to indicate that the microprocessor's carry bit has been set.

---

### Warning

The Exerciser does not protect you from serious mistakes. With a `WRITE_BLOCK` call you can easily overwrite a critical block on one of your disks, destroying valuable file data or even the disk's directory. With a careless `FORMAT` call, you can destroy all information on your disk. *Be careful how you use this program!*

---

---

---

## Other commands

In addition to practicing system calls, you may issue commands that allow you to list the contents of a directory, modify any part of the Apple IIGS RAM memory, enter the Monitor program, or quit the Exerciser.

---

### List Directory (L)

Press L and you are prompted for the pathname of the volume or subdirectory whose contents you wish to list. For each file in the directory, the listing shows file name, file type (see table A-2), number of blocks used, date and time of last modification, date and time of creation, EOF (logical size in bytes), and subtype (value of the auxiliary type field). Press the Escape key to return to the main menu.

---

### Modify Memory (M)

You use the Modify Memory command to place data in memory for ProDOS 16 to read, or to inspect the contents of a buffer that ProDOS 16 has written to.

Press M and you are prompted for a pointer to the part of memory you wish to access. Enter the proper address and press the Return key. A 256-byte (one-page) portion of memory is displayed, as 16 rows of 16 bytes each, beginning on a page boundary. Each row is preceded by the address of the first byte in that row; to the right of each row are the ASCII representations of the values of the bytes in the row.

Use the arrow keys to move the cursor around on the screen. To change the value of a byte, type the new value right over the old one. You can enter data in hexadecimal format only; the results of your entry are displayed on the screen in both hexadecimal and ASCII. For reference, Table C-1 lists ASCII characters and their decimal, hexadecimal, and binary equivalents.

You may undo up to the last 16 changes you made by typing U successively. To display the preceding or succeeding page in memory, press < or >.



**Table C-1**  
ASCII character set

Char	Dec	Hex	Binary	Char	Dec	Hex	Binary
nul	0	0	00000000	(	40	28	00101000
soh	1	1	00000001	)	41	29	00101001
stx	2	2	00000010	*	42	2A	00101010
etx	3	3	00000011	+	43	2B	00101011
eot	4	4	00000100	,	44	2C	00101100
enq	5	5	00000101	-	45	2D	00101101
ack	6	6	00000110	.	46	2E	00101110
bel	7	7	00000111	/	47	2F	00101111
ht	9	9	00001001	0	48	30	00110000
lf	10	A	00001010	1	49	31	00110001
vt	11	B	00001011	2	50	32	00110010
ff	12	C	00001100	3	51	33	00110011
cr	13	D	00001101	4	52	34	00110100
so	14	E	00001110	5	53	35	00110101
si	15	F	00001111	6	54	36	00110110
dle	16	10	00010000	7	55	37	00110111
dc1	17	11	00010001	8	56	38	00111000
dc2	18	12	00010010	9	57	39	00111001
dc3	19	13	00010011	:	58	3A	00111010
dc4	20	14	00010100	;	59	3B	00111011
nak	21	15	00010101	<	60	3C	00111100
syn	22	16	00010110	=	61	3D	00111101
etb	23	17	00010111	>	62	3E	00111110
can	24	18	00011000	?	63	3F	00111111
em	25	19	00011001	@	64	40	01000000
sub	26	1A	00011010	A	65	41	01000001
esc	27	1B	00011011	B	66	42	01000010
fs	28	1C	00011100	C	67	43	01000011
gs	29	1D	00011101	D	68	44	01000100
rs	30	1E	00011110	E	69	45	01000101
us	31	1F	00011111	F	70	46	01000110
sp	32	20	00100000	G	71	47	01000111
!	33	21	00100001	H	72	48	01001000
"	34	22	00100010	I	73	49	01001001
#	35	23	00100011	J	74	4A	01001010
\$	36	24	00100100	K	75	4B	01001011
%	37	25	00100101	L	76	4C	01001100
&	38	26	00100110	M	77	4D	01001101
'	39	27	00100111	N	78	4E	01001110



**Table C-1** (continued)  
ASCII character set

Char	Dec	Hex	Binary	Char	Dec	Hex	Binary
O	79	4F	01001111	h	104	68	01101000
P	80	50	01010000	i	105	69	01101001
Q	81	51	01010001	j	106	6A	01101010
R	82	52	01010010	k	107	6B	01101011
S	83	53	01010011	l	108	6C	01101100
T	84	54	01010100	m	109	6D	01101101
U	85	55	01010101	n	110	6E	01101110
V	86	56	01010110	o	111	6F	01101111
W	87	57	01010111	p	112	70	01110000
X	88	58	01011000	q	113	71	01110001
Y	89	59	01011001 <sup>a</sup>	r	114	72	01110010
Z	90	5A	01011010	s	115	73	01110011
[	91	5B	01011011	t	116	74	01110100
\	92	5C	01011100	u	117	75	01110101
]	93	5D	01011101	v	118	76	01110110
^	94	5E	01011110	w	119	77	01110111
_	95	5F	01011111	x	120	78	01111000
	96	60	01100000	y	121	79	01111001
a	97	61	01100001	z	122	7A	01111010
b	98	62	01100010	{	123	7B	01111011
	99	63	01100011		124	7C	01111100
d	100	64	01100100	}	125	7D	01111101
e	101	65	01100101	~	126	7E	01111110
f	102	66	01100110	del	127	7F	01111111
g	103	67	01100111				

---

**Warning** Modify Memory does not prevent you from changing values in parts of memory that are already in use. You can conceivably alter the Exerciser itself or other critical code, causing a system crash. Be careful what you modify!

---

### Exit to Monitor (X)

The Monitor is a firmware program (see *Apple IIGS Firmware Reference*) that allows you to inspect and modify the contents of memory, assemble and disassemble code in a limited manner, and execute code in memory. You may enter the Monitor from the ProDOS 16 Exerciser.

To call the Monitor, press M. When the Monitor prompt (\*) appears, you may issue any Monitor command. To leave the Monitor and return to the Exerciser, you must reboot the computer (press Control-C-Reset) and, if necessary, re-execute the Exerciser from the desktop or program launcher.

---

### Quit (Q)

To quit the ProDOS 16 exerciser, simply press Q. Of course, you may also quit by selecting the ProDOS 16 QUIT call (\$27), filling out the parameter block, and executing the call.



## Appendix D



# System Loader Technical Data

This appendix assembles some specific technical details on the System Loader. For more information, see the referenced publications.

---

---

### Object module format

The System Loader can load only code and data segments that conform to Apple IIGS **object module format**. Object module format is described in detail in *Apple IIGS Programmer's Workshop Reference*.

---

### File types

File types for load files and other OMF-related files are listed below. For a complete list of ProDOS file types, see Table A-2 in Appendix A.

File type	Description
\$B0	Source file ( <i>aux_type</i> defines language)
\$B1	Object file
\$B2	Library file
\$B3	Application file
\$B4	Run-time library file
\$B5	Shell application file
<i>\$B6 - \$BE</i>	<i>Reserved for system use. Currently defined types include:</i>
\$B6	Permanent initialization file
\$B7	Temporary initialization file
\$B8	New desk accessory
\$B9	Classic desk accessory

## Segment kinds

Whereas files are classified by type, segments are classified by **kind**. Each segment has a kind designation in the KIND field of its header. The five high-order bits in the KIND field describe specific attributes of the segment; the value in the low-order five-bit field describes the overall type of segment. Different combinations of attributes and type values yield different results for the segment kind.

The KIND field is two bytes long. Figure D-1 shows its format.

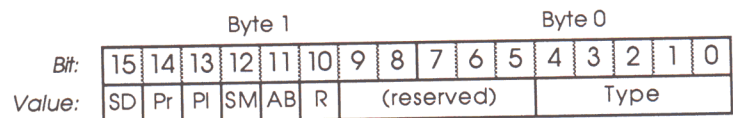

**Figure D-1**

Segment kind format

where the *attribute* bits (11-15) mean the following:

- |                    |                            |                              |
|--------------------|----------------------------|------------------------------|
| <b>SD</b> (bit 15) | = static/dynamic           | (0 = static;<br>1 = dynamic) |
| <b>Pr</b> (bit 14) | = private                  | (0 = no; 1 = yes)            |
| <b>PI</b> (bit 13) | = position-independent     | (0 = no; 1 = yes)            |
| <b>SM</b> (bit 12) | = may be in special memory | (0 = yes; 1 = no)            |

**AB** (bit 11) = absolute-bank (0 = no; 1 = yes)  
**R** (bit 10) = Reload (0 = no, 1 = yes)

and the *type* field (bits 0-4) describes one of the following classifications of the segment:

Value of Type	Description
\$00	code segment
\$01	data segment
\$02	Jump Table segment
\$04	Pathname segment
\$08	library dictionary segment
\$10	initialization segment
\$12	direct-page/stack segment

Segment attributes can be combined with particular types to yield different resultant values for KIND. For example, a *dynamic* Initialization Segment has KIND = \$8010.

- ❖ *Note:* A Reload segment is always loaded from the file when a program starts up, even if the program is restarted from memory. It is used to initialize data for programs that would not otherwise be restartable.

## Record codes

Load segments, like all OMF segments, are made up of records. Each type of record has a code number and a name. For a complete list of record types, see *Apple IIGS Programmer's Workshop Reference*. The only record types recognized by the System Loader are these:

Record Code	Name	Description
\$E2	RELOC	intra-segment relocation record (in relocation dictionary)
\$E3	INTERSEG	inter-segment relocation record (in relocation dictionary)
\$F1	DS	zero-fill record
\$F2	LCONST	long-constant record (the actual code and data for each segment)
\$F5	cRELOC	compressed intra-segment relocation record (in relocation dictionary)



Record Code	Name	Description
\$F6	cINTERSEG	compressed intersegment relocation record (in relocation dictionary)
\$F7	SUPER	super-compressed relocation record (the equivalent of many cRELOC or cINTERSEG records)
\$00	END	the end of the segment

If the loader encounters any other type of record in a load segment, it returns error \$110A.

---

### Load-file numbers

Load files processed by the Apple IIGS Programmer's Workshop Linker at any one time are numbered consecutively from 1. Load file 1 is called the initial load file. All other files are considered to be run-time libraries.

A load-file number of 0 in a Jump Table segment or a Pathname segment indicates the end of the segment.

---

### Load-segment numbers

In each load file created by the linker, segments are numbered consecutively by their position in the load file, starting at 1. The loader determines a segment's number by counting its position from the beginning of the load file. As a check, the loader also looks at the segment number in the segment's header.

The first static segment in a load file, which need not be segment number 1, is called the *main* segment—it is loaded first (except for any preceding initialization segments) and never leaves memory while the program is executing. Because a run-time library need have no static segments at all, it typically has no main segment.

---

## Segment headers

The first part of every object module format segment is a *segment header*; it contains 17 fields that give the name, size, and other important information about the segment.

### Restrictions on segment header values

Because OMF supports capabilities that are more general than the System Loader's needs, the System Loader permits load files to have only a subset of all possible OMF characteristics. The loader does this by restricting the values of several segment header fields:

NUMSEX:        must be 0  
NUMLEN:        must be 4  
BANKSIZE:      must be less than or equal to \$10 000  
ALIGN:         must be less than or equal to \$10 000

If the System Loader finds any other values in any of the above fields, it returns error \$110B ("Segment is Foreign"). The restrictions on BANKSIZE and ALIGN are enforced by the APW Linker also.

### Page-aligned and bank-aligned segments

In OMF, the values of BANKSIZE and ALIGN may be any multiple of 2. But because the Memory Manager and System Loader support only two types of alignment (page- and bank-alignment) and one bank size (64K), the System Loader uses both BANKSIZE and ALIGN values to control segment alignment, as follows.

1. If BANKSIZE is 0 or \$10 000, its value has no effect on segment alignment.
2. If BANKSIZE is any other value, the greater of BANKSIZE and ALIGN is called the *alignment factor*. Alignment in memory is controlled by the alignment factor in this way:
  - a. If the alignment factor is 0, the segment is not aligned to any memory boundary.
  - b. If the alignment factor is greater than 0 and less than or equal to \$100, the segment is page-aligned.
  - c. If the alignment factor is greater than \$100, the segment is bank-aligned.

- ❖ *Note:* The Memory Manager itself does not directly support bank-alignment. The System Loader forces bank alignment where needed by requesting blocks in successive banks until it finds one that starts on a bank boundary.

---

---

## Entry point and global variables

There is only one entry point needed for all System Loader calls (actually, all tool calls). It is to the Apple IIGS tool dispatcher, at the bottom of bank \$E1 (address \$E1 0000). Although the System Loader maintains memory space and a table of loader functions in other parts of memory, locations in those areas are not supported. Please make all System Loader calls with a JSL to \$E1 0000, as explained in Chapter 17 (or with macro calls or other higher-level interface, if appropriate for your language).

The following variables are of global significance. They are defined at the system level, so any application that needs to know their values may access them. However, only USERID is important to most applications, and it should be accessed only through proper calls to the System Loader. The other variables are needed by controlling programs only, and should not be used by applications.

SEGTBL	Absolute address of the Memory Segment Table
JMPTBL	Absolute address of the Jump Table Directory
PATHTBL	Absolute address of the Pathname Table
USERID	User ID of the current application

---

---

## User ID format

The User ID Manager is discussed in Chapter 5, and fully explained in *Apple IIGS Toolbox Reference*. Only the format of the User ID number, needed as a parameter for System Loader calls, is shown here.

There is a 2-byte User ID associated with every allocated memory block. It is divided into three fields: MainID, AuxID, and TypeID. The MainID field contains the unique number assigned to the owner of the block by the User ID Manager; every allocated block has a nonzero value in its MainID field. The AuxID field holds a user-assignable identification; it is ignored by the System Loader, ProDOS 16, and the User ID Manager. The TypeID field gives the general class of software to which the block belongs.



**Figure D-2**  
User ID format

MainID can have any value from \$01 to \$FF (0 is reserved).

AuxID can have any value from \$00 to \$0F.†

TypeID values are defined as follows:

- \$00 Memory Manager
- \$01 application
- \$02 controlling program
- \$03 ProDOS 8 and ProDOS 16
- \$04 tool set†
- \$05 desk accessory
- \$06 run-time library
- \$07 System Loader
- \$08 firmware/system function
- \$09 Tool Locator
- \$0A-F (undefined)

†If type ID = \$04, these values of AuxID are reserved:

- \$01 Miscellaneous Toolset file
- \$02 Scrap Manager file
- \$0A tool setup file



## Appendix E



### Error Codes

This appendix lists and describes all error codes returned by ProDOS 16 and the System Loader. Each error code is followed by the error's suggested name or screen message, and a brief description of its significance.

When an error occurs during a call, ProDOS 16 or the System Loader places the error number in the accumulator (A-register), sets the status register carry bit, and returns control to the calling routine.

If, after a call, the carry bit is clear and the accumulator contains 0, that signifies a successful completion (no error).

---

---

### ProDOS 16 errors

---

#### Nonfatal errors

A nonfatal error signifies that a requested call could not be completed properly, but program execution may continue.



Number	Message and Description
	<i>General Errors:</i>
\$00	(no error)
\$01	<b>Invalid call number:</b> A nonexistent command has been issued.
\$07	<b>ProDOS is busy:</b> The call cannot be made because ProDOS 16 is busy with another call.
	<i>Device call errors:</i>
\$10	<b>Device not found:</b> There is no device on line with the given name ( <code>GET_DEV_NUM</code> call).
\$11 <sup>*</sup>	<b>Invalid device request:</b> The given device name or reference number is not in ProDOS 16's list of active devices ( <code>VOLUME</code> , <code>READ_BLOCK</code> and <code>WRITE_BLOCK</code> calls).
\$25	<b>Interrupt vector table full:</b> The maximum number of user-defined interrupt handlers (16) has already been installed; there is no room for another ( <code>ALLOC_INTERRUPT</code> call).
\$27	<b>I/O error:</b> A hardware failure has prevented proper data transfer to or from a disk device. This is a general code covering many possible error conditions.
\$28	<b>No device connected:</b> There is no device in the slot and drive specified by the given device number ( <code>READ_BLOCK</code> , <code>WRITE_BLOCK</code> , and <code>VOLUME</code> calls).
\$2B	<b>Write-protected:</b> The specified volume is write-protected (the "write-protect" tab or notch on the diskjacket has been enabled). No operation that requires writing to the disk can be performed.
\$2D	<b>Invalid block address:</b> An attempt was made to read data from a RAM disk, at an address beyond its limits.
\$2E	<b>Disk switched:</b> The requested operation cannot be performed because a disk containing an open file has been removed from its drive.

---

**Warning**

Apple II drives have no hardware method for detecting disk switches. This error is therefore returned only when ProDOS 16 checks a volume name during the normal course of a call. Since most disk access calls do not involve a check of the volume name, a disk-switched error can easily go undetected.

---

- \$2F Device not on line:** A device specified in a call is not connected to the system, or has no volume mounted on it. This error may be returned by device drivers that can sense whether or not a specific device is on line.
- \$30 - \$3F Device-specific errors:** (error codes in this range are to be defined and used by individual device drivers.)
- File call errors:*
- \$40 Invalid pathname or device name syntax:** The specified pathname or device name contains illegal characters (other than A-Z, 0-9, .,/,\*).
- \$42 FCB table full:** The table of file control blocks is full; the maximum permitted number of open files (8) has already been reached. You may not open another file (OPEN call).
- \$43 Invalid file reference number:** The specified file reference number does not match that of any currently open file.
- \$44 Path not found:** A subdirectory name in the specified pathname does not exist (the pathname's syntax is otherwise valid).
- \$45 Volume not found:** The volume name in the specified pathname does not exist (the pathname's syntax is otherwise valid).
- \$46 File not found:** The last file name in the specified pathname does not exist (the pathname's syntax is otherwise valid).
- \$47 Duplicate pathname:** An attempt has been made to create or rename a file, using an already existing pathname (CREATE, CHANGE\_PATH calls).

- \$48**      **Volume full:** An attempt to allocate blocks on a disk device has failed, due to lack of space on the volume in the device (`CREATE`, `WRITE` calls). If this error occurs during a write, ProDOS 16 writes data until the disk is full, and still permits you to close the file.
- \$49**      **Volume directory full:** No more space for entries is left on the volume directory (`CREATE` call). In ProDOS 16, a volume directory can hold no more than 51 entries. No more files can be added to this directory until others are destroyed (deleted).
- \$4A**      **Version error (incompatible file format):** The version number in the specified file's directory entry does not match the present ProDOS 8-ProDOS 16 file format version number. This error can only occur in future versions of ProDOS 16, since for all present versions of ProDOS 8 and ProDOS 16 the file format version number is zero.
- ❖ *Note:* The version number referred to by this error code concerns the file format only, not the version number of the operating system as a whole. In particular, it is unrelated to the ProDOS 16 version number returned by the `GET_VERSION` call.
- \$4B**      **Unsupported (or incorrect) storage type:** The organization of the specified file is unknown to ProDOS 16. See Appendix A for a list of valid storage types.
- This error may also be returned if a directory has been tampered with, or if a prefix has been set to a nondirectory file.
- \$4C**      **End-of-file encountered (out of data):** A read has been attempted, but the current file position (`Mark`) is equal to end-of-file (`EOF`), and no further data can be read.
- \$4D**      **Position out of range:** The specified file position parameter (`Mark`) is greater than the size of the file (`EOF`).
- \$4E**      **Access not allowed:** One of the attributes in the specified file's access byte forbids the attempted operation (renaming, destroying, reading, or writing).

- \$50 File is open:** An attempt has been made to perform a disallowed operation on an open file (OPEN, CHANGE\_PATH, DESTROY calls).
- \$51 Directory structure damaged:** The number of entries indicated in the directory header does not match the number of entries the directory actually contains.
- \$52 Unsupported volume type:** The specified volume is not a ProDOS 16, ProDOS 8, or SOS disk. Its directory format is incompatible with ProDOS 16.
- \$53 Parameter out of range:** The value of one or more parameters in the parameter block is out of its range of permissible values.
- \$54 Out of Memory:** A ProDOS 8 program specified by the QUIT call is too large to fit into the memory space available for ProDOS 8 applications.
- \$55 VCB table full:** The table of volume control blocks is full; the maximum permitted number of online volumes/devices (8) has already been reached. You may not add another device to the system. The error occurs when 8 devices are on line and a VOLUME call is made for another device that has no open files.
- \$57 Duplicate volume:** Two or more online volumes have identical volume directory names. This message is a warning; it does not prevent access to either volume. However, ProDOS 16 has no way of knowing which volume is intended if the volume name is specified in a call; it will access the first one it finds.
- \$58 Not a block device:** An attempt has been made to access a device that is not a block device. Current versions of ProDOS 16 support access to block devices only.
- \$59 Invalid level:** The value specified for the system file level is out of range (SET\_LEVEL call).
- \$5A Block number out of range:** The volume bit map indicates that the volume contains blocks beyond the block count for the volume. This error may indicate a damaged disk structure.

- \$5B**      **Illegal pathname change:** The pathnames on a `CHANGE_PATH` call specify two different volumes. `CHANGE_PATH` can move files among directories only on the *same* volume.
- \$5C**      **Not an executable file:** The file specified in a `QUIT` call is not a launchable type. All applications launched by the `QUIT` call must be type `$B3` (ProDOS 16 application), `$B5` (shell application), or `$$$` (ProDOS 8 system file).
- \$5D**      **Operating system/file system not available:** (1) The `QUIT` call has specified a ProDOS 8 application to be launched, but the ProDOS 8 operating system is not on the system disk. (2) The `FORMAT` call is unable to format a disk for the specified file system.
- \$5E:**      **Cannot deallocate /RAM:** In quitting from a ProDOS 8-based program and launching a ProDOS 16-based program, `PQUIT` is not able to remove the ProDOS 8 RAM disk in bank `$01` (`QUIT` call).
- \$5F**      **Return stack overflow:** An attempt was made to add another User ID to the return stack maintained by `PQUIT`, but the stack already has 16 entries, its maximum permitted number (`QUIT` call).
- \$60**      **Data unavailable:** The system has invalid information on which device was last accessed (`GET_LAST_DEV` call).

---

## Fatal errors

A fatal error signifies the occurrence of a malfunction so serious that processing must halt. To resume execution following a fatal error, you must reboot the system.



Number	Message and Description
\$01	<b>Unclaimed interrupt:</b> An interrupt signal has occurred and none of the installed handlers claims responsibility for it. This error may occur if interrupt-producing hardware is installed before its associated interrupt handler is allocated.
\$0A	<b>VCB unusable:</b> The volume control block table has been damaged. The values of certain check bytes are not what they should be, so ProDOS 16 cannot use the VCB table.
\$0B	<b>FCB unusable:</b> The file control block table has been damaged. The values of certain check bytes are not what they should be, so ProDOS 16 cannot use the FCB table.
\$0C	<b>Block zero allocated illegally:</b> Write-access to block zero on a disk volume has been attempted. Block zero on all volumes is reserved for boot code.
\$0D	<b>Interrupt occurred while I/O shadowing off:</b> The Apple IIGS has soft switches that control shadowing from banks \$E0 and \$E1 to banks \$00 and \$01. If an interrupt occurs while those switches are off, the firmware interrupt-handling code will not be enabled. See <i>Apple IIGS Firmware Reference</i> .
\$11	<b>Wrong OS version:</b> The version number of the file P16 or P8 is different from the version number of the file PRODOS. PRODOS, which loads ProDOS 16 (P16) and ProDOS 8 (P8), requires compatible versions of both.

If a QUIT call results in the loading of a ProDOS 16-based application that is too large to fit in the available memory or that for some other reason cannot be loaded, execution halts and the following message is displayed on the screen:

```
Can't run next application. Error=$XXXX
```

where \$XXXX is an error code—typically a Tool Locator, Memory Manager, or System Loader error code.

---

## Bootstrap errors

Bootstrap errors can occur when the Apple IIGS attempts to start up a ProDOS 16 system disk. Errors can occur at several points in this process:

1. If there is no disk in the startup drive, a "sliding apple" symbol (  ) appears on the screen along with the message:

Check startup device!

Place a system disk in the drive and press Control--Reset to restart the boot procedure.

2. If there is a disk in the drive, but it is not a ProDOS 8 or ProDOS 16 system disk (that is, there is no type \$FF file named PRODOS on it), the following message appears:

UNABLE TO LOAD PRODOS

Remove the disk and replace it with another containing the proper files, then press Control--Reset to restart the boot procedure.

3. If the file named PRODOS is found, but another essential file is missing, a message such as

No SYSTEM/P16 file found

or

No x.SYSTEM or x.SYS16 file found

may appear. Remove the disk and replace it with another containing the proper files, then press Control--Reset to restart the boot procedure.

Another type of ProDOS 16 bootstrap error occurs on other Apple II systems. If you try to boot a ProDOS 16 system disk on a standard Apple II computer (one that is *not* an Apple IIGS), the following error message is displayed:

PRODOS 16 REQUIRES APPLE IIGS HARDWARE

When this occurs the disk will not boot. You can boot an Apple IIGS System Disk only on an Apple IIGS computer.

---

---

## System Loader errors

---

### Nonfatal errors

---

Number	Message and Description
\$0000	(no error)
\$1101	<b>Not found:</b> The specified segment (in the load file) or entry (in the Pathname Table or Memory Segment Table) does not exist. If the specified load file itself is not found, a ProDOS 16 error \$46 (file not found) is returned.
\$1102	<b>Incompatible OMF version:</b> The object module format version of a load segment (as specified in its header) is incompatible with the current version of the System Loader. The loader will not load such a segment.
\$1104	<b>File is not a load file:</b> The specified load file is not type \$B3-\$BE. See Appendix A or D for descriptions of these file types.
\$1105	<b>Loader is busy:</b> The call cannot be made because the System Loader is busy with another call.
\$1107	<b>File version error:</b> The specified file cannot be loaded because its creation date and time do not match those on its entry in the Pathname Table.
❖ <i>Note:</i>	This error applies to run-time library files only.
\$1108	<b>User ID error:</b> The specified User ID either doesn't exist (Application Shutdown), or doesn't match the User ID of the specified segment (Unload Segment By Number).
\$1109	<b>SegNum out of sequence:</b> The value of the SEGNUM field in the segment's header doesn't match the number by which the segment was specified (Load Segment By Number, Initial Load).
\$110A	<b>Illegal load record found:</b> A record in the segment is of a type not accepted by the loader.

**\$110B**     **Load segment is foreign:** The values in the NUMSEX and NUMLEN fields in the specified segment's header are not 0 and 4, respectively (Load Segment By Number).

**\$001-\$05F** (ProDOS 16 I/O errors—see “ProDOS 16 Errors” in this appendix.)

**\$201-\$20A** (Memory Manager errors—see *Apple IIGS Toolbox Reference*.)

---

## Fatal errors

If a ProDOS 16 error or Memory Manager error occurs while the System Loader is making an internal call, it is a fatal error. The most common case is when a Jump Table Load is attempted for a dynamic load segment or run-time library segment whose volume is not on line. Control is transferred to the System Failure Manager, and the following message appears on the screen:

```
Error loading Dynamic Segment-XXXX
```

where *XXXX* is the error code of the ProDOS 16 or Memory manager error that occurred.



# Glossary

**absolute:** Characteristic of a load segment or other program code that must be loaded at a specific address in memory, and never moved. Compare **relocatable**.

**access byte:** An attribute of a ProDOS 16 file that determines what types of operations, such as reading or writing, may be performed on the file.

**accumulator:** The register in the microprocessor where most computations are performed.

**address:** A number that specifies the location of a single **byte** of memory. Addresses can be given as decimal or hexadecimal integers. The Apple IIGS has addresses ranging from 0 to 16,777,215 (in decimal) or from \$00 00 00 to \$FF FF FF (in hexadecimal). A complete address consists of a 4-bit **bank** number (\$00 to \$FF) followed by a 16-bit address within that bank (\$00 00 to \$FF FF).

**Apple IIGS Programmer's Workshop:** The development environment for the Apple IIGS computer. It consists of a set of programs that facilitate the writing, compiling, and debugging of Apple IIGS applications.

**application program (or application):** (1) A program that performs a specific task useful to the computer user, such as word processing, data base management, or graphics. Compare **controlling program, shell application, system program**. (2) On the Apple IIGS, a program that accesses ProDOS 16 and the Toolbox directly, and that can be called or exited via the QUIT call. ProDOS 16 applications are **file type** \$B3.

**APW:** See **Apple IIGS Programmer's Workshop**.

**APW Linker:** The linker supplied with APW.

**ASCII:** Acronym for *American Standard Code for Information Interchange*. A code in which the numbers from 0 to 127 stand for text characters. ASCII code is used for representing text inside a computer and for transmitting text between computers or between a computer and a peripheral device.

**assembler:** A program that produces **object files** (programs that contain machine-language code) from **source files** written in assembly language. Compare **compiler**.

**AuxID:** One of three fields in the **User ID**, a number that identifies each application.

**backup bit:** A bit in a file's **access byte** that tells backup programs whether the file has been altered since the last time it was backed up.

**bank:** A 64K (65,536-byte) portion of the Apple IIGS internal memory. An individual bank is specified by the value of one of the 65C816 microprocessor's bank registers.



**bank-switched memory:** On Apple II computers, that part of the **language card** memory in which two 4K-portions of memory share the same address range (\$D000-\$DFFF).

**binary file:** (1) A file whose data is to be interpreted in binary form. Machine-language programs and pictures are stored in binary files. Compare **text file**. (2) A file in **binary file format**.

**binary file format:** The ProDOS 8 loadable file format, consisting of one absolute memory image along with its destination address. A file in binary file format has ProDOS file type \$06 and is referred to as a BIN file. The System Loader cannot load BIN files.

**bit:** A contraction of *binary digit*. The smallest unit of information that a computer can hold. The value of a bit (1 or 0) represents a simple two-way choice, such as yes or no or on or off.

**bit map:** A set of bits that represents the positions and states of a corresponding set of items. *See*, for example, **global page bit map** or **volume bit map**.

**block:** (1) A unit of data storage or transfer, typically 512 bytes. (2) A contiguous, page-aligned region of computer memory of arbitrary size, allocated by the Memory Manager. Also called a *memory block*.

**block device:** A device that transfers data to or from a computer in multiples of one block (512 bytes) of characters at a time. Disk drives are block devices.

**boot:** Another way to say *start up*. A computer boots by loading a program into memory from an external storage medium such as a disk. *Boot* is short for *bootstrap load*: Starting up is often accomplished by first loading a small program, which then reads a larger program into memory. The program is said to "pull itself up by its own bootstraps."

**buffer:** A region of memory where information can be stored by one program or device and then read at a different rate by another; for example, a ProDOS 16 I/O buffer.

**Busy word:** A firmware flag, consulted by the **Scheduler**, that protects system software that is not **reentrant** from being called while processing another call.

**byte:** A unit of information consisting of a sequence of 8 **bits**. A byte can take any value between 0 and 255 (\$0 and \$FF hexadecimal). The value can represent an instruction, number, character, or logical state.

**call:** (v.) To request the execution of a subroutine, function, or procedure. (n.) As in operating system calls, a request from the keyboard or from a program to execute a named function.

**call block:** The sequence of assembly-language instructions used to call ProDOS 16 or System Loader functions.

**carry flag:** A status bit in the microprocessor, used as an additional high-order bit with the accumulator bits in addition, subtraction, rotation, and shift operations.

**character:** Any symbol that has a widely understood meaning and thus can convey information. Most characters are represented in the computer as one-byte values.

**character device:** A device that transfers data to or from a computer as a stream of individual characters. Keyboards and printers are character devices.

**close:** To terminate access to an open file. When a file is closed, its updated version is written to disk and all resources it needed when open (such as its I/O buffer) are released. The file must be opened before it can be accessed again.

**compact:** To rearrange allocated memory blocks in order to increase the amount of contiguous unallocated (free) memory. The Memory Manager compacts memory when needed.

**compiler:** A program that produces **object files** (containing machine-language code) from **source files** written in a high-level language such as C. Compare **assembler**.

**controlling program:** A program that loads and runs other programs, without itself relinquishing control. A controlling program is responsible for shutting down its subprograms and freeing their memory space when they are finished. A shell, for example, is a controlling program.

**creation date:** An attribute of a ProDOS 16 file; it specifies the date on which the file was first created.

**creation time:** An attribute of a ProDOS 16 file; it specifies the time at which the file was first created.

**current application:** The application program currently loaded and running. Every application program is identified by a User ID number; the current application is defined as that application whose User ID is the present value of the `USERID` global variable.

**data block:** A 512-byte portion of a ProDOS 16 **standard file** that consists of whatever kind of information the file may contain.

**default prefix:** The pathname **prefix** attached by ProDOS 16 to a **partial pathname** when no **prefix number** is supplied by the application. The default prefix is equivalent to prefix number 0/.

**dereference:** To substitute a **pointer** for a **memory handle**. When you dereference a memory block's handle, you access the block directly (through its **master pointer**) rather than indirectly (through its handle).

**desk accessories:** Small, special-purpose programs that are available to the user regardless of which application is running—such as the Control Panel, Calculator, Note Pad, and Alarm Clock.

**desktop:** The visual interface between the computer and the user. In computers that support the desktop concept, the desktop consists of a menu bar at the top of the screen, and a gray area in which applications are opened as windows. The desktop interface was first developed for the Macintosh computer.

**device:** A piece of equipment (hardware) used in conjunction with a computer and under the computer's control. Also called a **peripheral device** because such equipment is often physically separate from, but attached to, the computer.

**device driver:** A program that manages the transfer of information between a computer and a peripheral device.

**direct page:** A page (256 bytes) of bank \$00 of Apple IIGS memory, any part of which can be addressed with a short (one byte) address because its high address byte is always \$00 and its middle address byte is the value of the 65C816 **direct register**. Co-resident programs or routines can have their own direct pages at different locations. The direct page corresponds to the 6502 processor's **zero page**. The term *direct page* is often used informally to refer to any part of the lower portion of the **direct-page/stack space**.

**direct-page/stack space:** A portion of bank \$00 of Apple IIGS memory reserved for a program's **direct page** and **stack**. Initially, the 65C816 processor's **direct register** contains the base address of the space, and its **stack register** contains the highest address. In use, the stack grows downward from the top of the direct-page/stack space, and the lower part of the space contains direct-page data.

**direct register:** A hardware register in the 65C816 processor that specifies the start of the direct page.

**directory file:** One of the two principal categories of ProDOS 16 files. Directory files contain specifically formatted entries that contain the names and disk locations of other files. Compare **standard file**. Directory files are either **volume directories** or **subdirectories**.

**disk device:** See **block device**.

**disk operating system:** An operating system whose principal function is to manage files and communication with one or more disk drives.

**DOS** and **ProDOS** are two families of Apple II disk operating systems.

**dispose:** To permanently deallocate a memory block. The Memory Manager disposes of a memory block by removing its master pointer. Any handle to that pointer will then be invalid. Compare **purge**.

**dormant:** Said of a program that is not being executed, but whose essential parts are all in the computer's memory. A dormant program may be quickly **restarted** because it need not be reloaded from disk.

**DOS:** An Apple II disk operating system. *DOS* is an acronym for *Disk Operating System*.

**dynamic segment:** A segment that can be loaded and unloaded during execution as needed. Compare **static segment**.

**e flag:** A flag bit in the 65C816 that determines whether the processor is in **native mode** or **emulation mode**.

**8-bit Apple II:** See **standard Apple II**.

**emulation mode:** The 8-bit configuration of the 65C816 processor, in which it functions like a 6502 processor in all respects except clock speed.

**EOF (end-of-file):** The logical size of a ProDOS 16 file; it is the number of bytes that may be read from or written to the file.

**error (or error condition):** The state of a computer after it has detected a fault in one or more commands sent to it.

**error code:** A number or other symbol representing a type of error.

**event:** A notification to an application of some occurrence (such as an interrupt generated by a keypress) that the application may want to respond to.

**event-driven:** A kind of program that responds to user inputs in real time by repeatedly testing for events posted by interrupt routines. An event-driven program does nothing until it detects an event such as a keypress.

**external device:** See **device**.

**fatal error:** An error serious enough that the computer must halt execution.

**file:** A named, ordered collection of information stored on a disk.

**file control block (FCB):** A data structure set up in memory by ProDOS 16 to keep track of all open files.

**file entry** or **file directory entry:** The part of a ProDOS 16 directory or subdirectory that describes and points to another file. The file so described is considered to be "in" or "under" that directory.

**file level:** See **system file level**.

**filename:** The string of characters that identifies a particular file within its directory. ProDOS 16 filenames may be up to 15 characters long. Compare **pathname**.



**file system ID:** A number describing the general category of operating system to which a file or volume belongs. The file system ID is an input to the ProDOS 16 `FORMAT` call, and a result from the `VOLUME` call.

**file type:** An attribute in a ProDOS 16 file's directory entry that characterizes the contents of the file and indicates how the file may be used. On disk, file types are stored as numbers; in a directory listing, they are often displayed as three-character mnemonic codes.

**filing calls:** Operating system calls that manipulate files. In ProDOS 16, filing calls are subdivided into *file housekeeping calls* and *file access calls*.

**finder:** A program that performs file and disk utilities (formatting, copying, renaming, and so on) and also starts applications at the request of the user.

**firmware:** Programs stored permanently in the computer's read-only memory (ROM). They can be executed at any time but cannot be modified or erased.

**fixed:** Not movable in memory once allocated. Also called *unmovable*. Program segments that must not be moved are placed in fixed memory blocks. Opposite of **movable**.

**flush:** To update an open file (write any updated information to disk) without closing it.

**global page:** Under ProDOS 8, 256 bytes of data at a fixed location in memory, containing useful system information (such as a list of active devices) available to any application.

**global page bit map:** A portion of the ProDOS 8 global page that keeps track of memory use in the computer. Applications under ProDOS 8 are responsible for marking and clearing parts of the bit map that correspond to memory they have allocated or freed.

**guest file system:** A file system, other than ProDOS 16's, whose files can be read by ProDOS 16.

**handle:** See **memory handle**.

**hexadecimal:** The base-16 system of numbers, using the ten digits 0 through 9 and the six letters A through F. Hexadecimal numbers can be converted easily and directly to binary form, because each hexadecimal digit corresponds to a sequence of four bits. In Apple manuals hexadecimal numbers are usually preceded by a dollar sign (\$).

**hierarchical file system:** A method of organization in which disk files are grouped together within **directories** and **subdirectories**. In a hierarchical file system, a file is specified by its **pathname**, rather than by a single filename.

**high-order:** The most significant part of a numerical quantity. In normal representation, the high-order bit of a binary value is in the leftmost position; likewise, the high-order byte of a binary **word** or **long word** quantity consists of the leftmost eight bits.

**Human Interface Guidelines:** A set of software development guidelines developed by Apple Computer to support the **desktop** concept and to promote uniform user interfaces in Apple II and Macintosh applications.

**image:** A representation of the contents of memory. A code image consists of machine-language instructions or data that may be loaded unchanged into memory.

**index block:** A 512-byte part of a ProDOS 16 **standard file** that consists entirely of pointers to other parts (**data blocks**) of the file.

**initial load file:** The first file of a program to be loaded into memory. It contains the program's main segment and the load file tables (Jump Table segment and Pathname segment) needed to load dynamic segments and run-time libraries.

**initialization segment:** A segment in an initial load file that is loaded and executed independently of the rest of the program. It is commonly executed first, to perform any initialization that the program may require.

**input/output:** The transfer of information between a computer's memory and peripheral devices.

**interrupt:** A temporary suspension in the execution of a program that allows the computer to perform some other task, typically in response to a signal from a device or source external to the computer.

**interrupt handler:** A program, associated with a particular external device, that executes whenever that device sends an interrupt signal to the computer. The interrupt handler performs its tasks during the interrupt, then returns control to the computer so it may resume program execution.

**interrupt vector table:** A table maintained in memory by ProDOS 16 that contains the addresses of all currently active (allocated) interrupt handlers.

**INTERSEG record:** A part of a relocation dictionary. It contains relocation information for external (intersegment) references.

**I/O:** See *input/output*.

**JML:** Unconditional Long Jump; a 65C816 assembly-language op code. It takes a 3-byte address operand. A JML can reach any address in the Apple IIGS memory space.

**JMP:** Unconditional Jump; a 6502 and 65C816 assembly-language op code. It takes a 2-byte address operand. A JMP can reach addresses only within a single 64K **bank** of the Apple IIGS memory space.

**JSL:** Long Jump to Subroutine; a 65C816 assembly-language op code. It takes a 3-byte address operand. A JSL can access any address in the Apple IIGS memory space.

**JSR:** Jump to Subroutine; a 6502 and 65C816 assembly-language op code. It takes a 2-byte address operand. A JSR can access addresses only within a single 64K **bank** of the Apple IIGS memory space.

**Jump Table:** A table constructed in memory by the System Loader from all Jump Table segments encountered during a load. The Jump Table contains all references to dynamic segments that may be called during execution of the program.

**Jump Table directory:** A master list in memory, containing pointers to all segments that make up the Jump Table.

**Jump Table segment:** A segment in a load file that contains all references to dynamic segments that may be called during execution of that load file. The Jump Table segment is created by the linker. In memory, the loader combines all Jump Table segments it encounters into the **Jump Table**.

**K:** Kilobyte. 1024 (2<sup>10</sup>) bytes.

**kernel:** The central part of an operating system. ProDOS 16 is the kernel of the Apple IIGS operating system.

**key block:** The first block in any ProDOS 16 file.

**kind:** See *segment kind*.

**language card:** Memory with addresses between \$D000 and \$FFFF on any Apple II-family computer. It includes two RAM banks in the \$Dxxx space, called **bank-switched memory**. The *language card* was originally a peripheral card for the 48K Apple II or Apple II Plus that expanded its memory capacity to 64K and provided space for an additional dialect of BASIC.



**level:** *See* system file level.

**library file:** An object file containing program segments, each of which can be used in any number of programs. The linker can search through the library file for segments that have been referenced in the program source file.

**linker:** A program that combines files generated by compilers and assemblers, resolves all symbolic references, and generates a file that can be loaded into memory and executed.

**load file:** The output of the linker. Load files contain memory images that the system loader can load into memory, together with **relocation dictionaries** that the loader uses to relocate references.

**load segment:** A segment in a load file.

**lock:** To prevent a memory block from being moved or purged. A block may be locked or unlocked by the Memory Manager, or by an application through a call to the System Loader.

**long word:** A double-length word. For the Apple IIGS, a long word is 32 bits (4 bytes) long.

**low-order:** The least significant part of a numerical quantity. In normal representation, the low-order bit of a binary number is in the rightmost position; likewise, the low-order byte of a binary **word** or **long word** quantity consists of the rightmost eight bits.

**m flag:** A flag in the 65C816 processor that determines whether the accumulator is 8 bits wide or 16 bits wide.

**macro:** A single predefined assembly-language pseudo-instruction that an assembler replaces with several actual instructions. Macros are almost like higher-level instructions that can be used inside assembly-language programs, making them easier to write.

**MainID:** One of three fields in the **User ID**, a number that identifies each application.

**main segment:** The first static segment (other than initialization segments) in the initial load file of a program. It is loaded at startup and never removed from memory until the program terminates.

**Mark:** The current position in an open file. It is the point in the file at which the next read or write operation will occur.

**Mark List:** A table maintained in memory by the System Loader to help it perform relocation rapidly.

**master index block:** The key block in a ProDOS 16 **tree file**, the largest organization of a **standard file** that ProDOS 16 can support. The master index block consists solely of pointers to one or more **index blocks**.

**master pointer:** A pointer to a memory block; it is kept by the Memory Manager. Each allocated memory block has a master pointer, but the block is normally accessed through its memory handle (which points to the master pointer), rather than through the master pointer itself.

**Mb:** Megabyte. 1,048,576 ( $2^{20}$ ) bytes.

**memory block:** *See* **block** (2).

**memory handle:** The identifying number of a particular block of memory. It is a pointer to the master pointer to the memory block. A handle rather than a simple pointer is needed to reference a movable memory block; that way the handle will always be the same though the value of the pointer may change as the block is moved around.

**Memory Manager:** A program in the Apple IIGS Toolbox that manages memory use. The Memory Manager keeps track of how much memory is available, and allocates memory **blocks** to hold program segments or data.

**Memory Segment Table:** A linked list in memory, created by the loader, that allows the loader to keep track of the segments that have been loaded into memory.

**MLI:** Machine Language Interface—the part of ProDOS 8 that processes operating system calls.

**modification date:** An attribute of a ProDOS 16 file; it specifies the date on which the content of the file was last changed.

**modification time:** An attribute of a ProDOS 16 file; it specifies the time at which the content of the file was last changed.

**monitor:** *See* **video monitor**.

**Monitor program:** A program built into the firmware of Apple II computers, used for directly inspecting or changing the contents of main memory and for operating the computer at the machine-language level.

**move:** To change the location of a memory block. The Memory Manager may move blocks to consolidate memory space.

**movable:** A memory block attribute, indicating that the Memory Manager is free to move the block. Opposite of **fixed**. Only **position-independent** program segments may be in movable memory blocks. A block is made movable or fixed through Memory Manager calls.

**native mode:** The 16-bit operating configuration of the 65C816 processor.

**newline mode:** A file-reading mode in which each character read from the file is compared to a specified character (called the *newline character*); if there is a match, the read is terminated. Newline mode is typically used to read individual lines of text, with the newline character defined as a carriage return.

**nibble:** A unit of information consisting of one-half of a **byte**, or 4 **bits**. A nibble can take on any value between 0 and 15 (\$0 and \$F hexadecimal).

**NIL:** Pointing to a value of 0. A memory handle is NIL if the address it points to is filled with zeros. Handles to purged memory blocks are NIL.

**null:** Zero.

**null prefix:** A prefix of zero length (and therefore nonexistent).

**object file:** The output from an assembler or compiler, and the input to a linker. It contains machine-language instructions. Also called *object program* or *object code*. Compare **source file**.

**object module format:** The general format used in Apple IIGS object files, library files, and load files.

**OMF file:** Any file in object module format.

**op code:** *See* **operation code**.

**operating system call:** A request to execute a named operating system function; also, the name of the function itself. OPEN, GET\_FILE\_INFO, and QUIT are ProDOS 16 operating system calls

**open:** To allow access to a file. A file may not be read from or written to until it is open.

**operand:** The part of an assembly language instruction that follows the **operation code**. The operand is used as a value or an address, or to calculate a value or an address.

**operating environment:** The overall hardware and software setting within which a program runs. Also called *execution environment*.

**operating system:** A program that organizes the actions of the various parts of the computer and its peripheral devices. *See also* **disk operating system**.

**operation code:** The part of a machine-language instruction that specifies the operation to be performed. Often called *op code*.

**page:** (1) A portion of memory 256 bytes long and beginning at an address that is an even multiple of 256. Memory blocks whose starting addresses are an even multiple of 256 are said to be *page-aligned*. (2) An area of main memory containing text or graphical information being displayed on the screen.

**parameter:** A value passed to or from a function or other routine.

**parameter block:** A set of contiguous memory locations, set up by a calling program to pass parameters to and receive results from an operating system function that it calls. Every call to ProDOS 16 must include a pointer to a properly constructed parameter block.

**partial pathname:** A portion of a **pathname** including the **filename** of the desired file but excluding the volume directory name (and possibly one or more of the subdirectories in the pathname). It is the part of a pathname following a **prefix**—a prefix and a partial pathname together constitute a full pathname. A partial pathname does not begin with a slash because it has no volume directory name.

**patch:** To replace one or more bytes in memory or in a file with other values. The address to which the program must jump to execute a subroutine is *patched* into memory at load time when a file is **relocated**.

**pathname:** The complete name by which a file is specified. It is a sequence of **filenames** separated by slashes, starting with the filename of the volume directory and following the path through any subdirectories that a program must follow to locate the file. A complete pathname always begins with a slash (/), because volume directory names always begin with a slash.

**Pathname segment:** segment in a load file that contains the cross-references between load files referenced by number (in the Jump Table segment) and their pathnames (listed in the file directory). The Pathname segment is created by the linker.

**Pathname Table:** A table constructed in memory from all individual Pathname segments encountered during loads. It contains the cross-references between load files referenced by number (in the Jump Table) and their pathnames (listed in the file directory).

**pointer:** An item of information consisting of the memory address of some other item. For example, the 65C816 stack register contains a pointer to the top of the stack.

**position-independent:** Code that is written specifically so that its execution is unaffected by its position in memory. It can be moved without needing to be relocated.

**prefix:** A portion of a **pathname** starting with a volume name and ending with a subdirectory name. It is the part of a pathname before the **partial pathname**—a prefix and a partial pathname together constitute a full pathname. A prefix always starts with a slash (/) because a volume directory name always starts with a slash.

**prefix number:** A code used to represent a particular prefix. Under ProDOS 16, there are nine prefix numbers, each consisting of a number (or asterisk) followed by a slash: 0/, 1/, ..., 8/, and \*/.

**ProDOS:** A family of disk operating systems developed for the Apple II family of computers. *ProDOS* stands for *Professional Disk Operating System*, and includes both ProDOS 8 and ProDOS 16.



**ProDOS 8:** A disk operating system developed for standard Apple II computers. It runs on 6502-series microprocessors. It also runs on the Apple IIGS when the 65C816 processor is in 6502 **emulation mode**.

**ProDOS 16:** A **disk operating system** developed for 65C816 **native mode** operation on the Apple IIGS. It is functionally similar to **ProDOS 8** but more powerful.

**pull:** To remove the top entry from a **stack**, moving the stack pointer to the entry below it. Synonymous with *pop*. Compare **push**.

**purge:** To temporarily deallocate a memory block. The Memory Manager purges a block by setting its master pointer to NIL (0). All handles to the pointer are still valid, so the block can be reconstructed quickly. Compare **dispose**.

**purge level:** An attribute of a memory block that sets its priority for purging. A purge level of 0 means that the block is unpurgeable.

**purgeable:** A memory block attribute, indicating that the Memory Manager may purge the block if it needs additional memory space. Purgeable blocks have different **purge levels**, or priorities for purging; these levels are set by Memory Manager calls.

**push:** To add an item to the top of a **stack**, moving the stack pointer to the next entry above the top. Compare **push**.

**queue:** A list in which entries are added at one end and removed at the other, causing entries to be removed in first-in, first-out (FIFO) order. Compare **stack**.

**quit return stack:** A stack maintained in memory by ProDOS 16. It contains a list of programs that have terminated but are scheduled to return when the presently executing program is finished.

**random-access device:** See **block device**.

**record:** A component of an load segment. All OMF file segments are composed of records, some of which are program code and some of which contain cross-reference or relocation information.

**reentrant:** Said of a routine that is able to accept a call while one or more previous calls to it are pending, without invalidating the previous calls. Under certain conditions, the **Scheduler** manages execution of programs that are not reentrant.

**reference:** (n) The name of a segment or entry point to a segment; same as *symbolic reference*. (v) To refer to a symbolic reference or to use one in an expression or as an address.

**Reload segment:** a load-file segment that is always loaded from the file at program startup, regardless of whether the rest of the program is loaded from file or restarted from memory. Reload segments contain initialization information, without which certain types of programs would not be restartable.

**RELOC record:** A part of a relocation dictionary that contains relocation information for local (within-segment) references.

**relocate:** To modify a file or segment at load time so that it will execute correctly at its current memory location. Relocation consists of **patching** the proper values onto address operands. The loader relocates load segments when it loads them into memory. See also **relocatable**.

**relocatable:** Characteristic of a load segment or other program code that includes no absolute addresses, and so can be relocated at load time. A relocatable segment can be static, dynamic, or position independent. It consists of a code **image** followed by a **relocation dictionary**. Compare **absolute**.

**relocation dictionary:** A portion of a load segment that contains relocation information necessary to modify the memory image portion of the segment. *See* **relocate**.

**restart:** To reactivate a **dormant** program in the computer's memory. The System Loader can restart dormant programs if all their static segments are still in memory. If any critical part of a dormant program has been purged by the Memory Manager, the program must be reloaded from disk instead of restarted.

**restartable:** Said of a program that reinitializes its variables and makes no assumptions about machine state each time it gains control. Only restartable programs can be executed from a **dormant** state in memory.

**result:** An item of information returned to a calling program from a function. Compare **value**.

**RTL:** Return from subroutine Long; a 65C816 assembly-language instruction. It is used in conjunction with a JSL instruction.

**RTS:** Return from Subroutine; a 6502 and 65C816 assembly-language instruction. It is used in conjunction with a JSR instruction.

**run-time library file:** A load file containing program segments—each of which can be used in any number of programs—that the System Loader loads dynamically when they are needed.

**sapling file:** An organizational form of a ProDOS 16 **standard file**. A sapling file consists of a single **index block** and up to 256 **data blocks**.

**Scheduler:** A firmware program that manages requests to execute **interrupted** software that is not **reentrant**. If, for example, an interrupt handler needs to make ProDOS 16 calls, it must do so through the Scheduler because ProDOS 16 is not reentrant. Applications need not use the Scheduler because ProDOS 16 is not in an interrupted state when it processes applications' system calls.

**sector:** A division of a **track** on a disk. When a disk is formatted, its surface is divided into tracks and sectors.

**seedling file:** An organizational form of a ProDOS 16 **standard file**. A seedling file consists of a single **data block**.

**segment:** A component of an OMF file, consisting of a header and a body. In load files, each segment incorporates one or more subroutines.

**segment kind:** A numerical designation used to classify a segment in object module format. It is the value of the **KIND** field in the segment's header.

**sequential-access device:** *See* **character device**.

**shadowing:** The process whereby any changes made to one part of the Apple IIGS memory are automatically and simultaneously copied into another part. When shadowing is on, information written to bank \$00 or \$01 is automatically copied into equivalent locations in bank \$E0 or \$E1. Likewise, any changes to bank \$E0 or \$E1 are immediately reflected in bank \$00 or \$01.

**shell application:** A type of program that is launched from a **controlling program** and runs under its control. Shell applications are ProDOS 16 file type \$B5.

**soft switch:** A location in memory that produces some specific effect whenever its contents are read or written.

**source file:** An ASCII file consisting of instructions written in a particular language, such as Pascal or assembly language. An assembler or compiler converts source files into **object files**.



**sparse file:** A variation of the organizational forms of ProDOS 16 **standard files**. A sparse file may be either a **sapling file** or a **tree file**; what makes it sparse is the fact that its logical size (defined by its **EOF**) is greater than its actual size on disk. This occurs when one or more **data blocks** contain nothing but zeros. Those data blocks are considered to be part of the file, but they are not actually allocated on disk until nonzero data is written to them.

**special memory:** On an Apple IIGS, all of banks \$00 and \$01, and all display memory in banks \$E0 and \$E1. So called because it is the memory directly accessed by **standard Apple II** programs running on the Apple IIGS.

**stack:** A list in which entries are added (pushed) and removed (pulled) at one end only (the top of the stack), causing them to be removed in last-in, first-out (LIFO) order. The term *the stack* usually refers to the particular stack pointed to by the 65C816's **stack register**. Compare **queue**.

**stack register:** A hardware register in the 65C816 processor that contains the address of the top of the processor's **stack**.

**standard Apple II:** Any computer in the Apple II family except the Apple IIGS. That includes the Apple II, the Apple II Plus, the Apple IIe, and the Apple IIc.

**standard file:** One of the two principal categories of ProDOS 16 files. Standard files contain whatever data they were created to hold; they have no predefined internal format. Compare **directory file**.

**start up:** To get the system running. It involves loading system software from disk, and then loading and running an application. Also called *boot*.

**static segment:** A segment that is loaded only at program boot time, and is not unloaded during execution. Compare **dynamic segment**.

**storage type:** An attribute of a ProDOS 16 file that describes the file's organizational form (such as directory file, seedling file, or sapling file).

**subdirectory:** A ProDOS 16 directory file that is not the volume directory.

**switcher:** A controlling program that rapidly transfers execution among several applications.

**system:** A coordinated collection of interrelated and interacting parts organized to perform some function or achieve some purpose—for example, a computer system comprising a processor, keyboard, monitor, disk drive, and software.

**system call:** See **operating system call**.

**system disk:** A disk that contains the operating system and other system software needed to run applications.

**System Failure Manager:** A firmware program that processes fatal errors by displaying a message on the screen and halting execution.

**system file:** See **system program**.

**system file level:** A number between \$00 and \$FF associated with each open ProDOS 16 file. Every time a file is opened, the current value of the system file level is assigned to it. If the system file level is changed (by a `SET_LEVEL` call), all subsequently opened files will have the new level assigned to them. By manipulating the system file level, a controlling program can easily close or flush files opened by its subprograms.

**System Loader:** The program that manages the loading and relocation of load segments (programs) into the Apple IIGS memory. The System Loader works closely with ProDOS 16 and the Memory Manager.

**system program:** (1) A software component of a computer system that supports **application programs** by managing system resources such as memory and I/O devices. Also called *system software*. (2) Under ProDOS 8, a stand-alone and potentially self-booting application. A ProDOS 8 system program is of file type \$FF; if it is self-booting, its filename has the extension `.SYSTEM`.

**system software:** The components of a computer system that support **application programs** by managing system resources such as memory and I/O devices.

**tool:** See **tool set**.

**tool set:** A group of related routines (usually in firmware), available to applications and system software, that perform necessary functions or provide programming convenience. The Memory Manager, the System Loader, and QuickDraw II are tool sets.

**toolbox:** A collection of built-in routines on the Apple IIGS that programs can call to perform many commonly-needed functions. Functions within the toolbox are grouped into **tool sets**.

**track:** One of a series of concentric circles on a disk. When a disk is formatted, its surface is divided into tracks and **sectors**.

**tree file:** An organizational form of a ProDOS 16 **standard file**. A tree file consists of a single **master index block**, up to 127 **index blocks**, and up to 32,512 **data blocks**.

**TypeID:** One of three fields in the **User ID**, a number that identifies each application.

**unload:** To remove a load segment from memory. To unload a segment, the System Loader does not actually "unload" anything; it calls the Memory Manager to either **purge** or **dispose** of the memory block in which the code segment resides. The loader then modifies the Memory Segment Table to reflect the fact that the segment is no longer in memory.

**unmovable:** See **fixed**.

**unpurgeable:** Having a **purge level** of zero, the Memory Manager is not permitted to purge memory blocks whose purge level is zero.

**User ID:** An identification number that specifies the owner of every memory block allocated by the Memory Manager. User ID's are assigned by the User ID Manager.

**User ID Manager:** A tool set that is responsible for assigning User ID's to every block of memory allocated by the Memory Manager.

**value:** An item of information passed from a calling routine to a function. Compare **result**.

**video monitor:** A display device that receives video signals by direct connection only.

**version:** A number indicating the release edition of a particular piece of software. Version numbers for most system software (such as ProDOS 16 and the System Loader) are available through function calls.

**volume:** An object that stores data; the source or destination of information. A volume has a name and a volume directory with the same name; information on a volume is stored in **files**. Volumes typically reside in **devices**; a device such as a floppy disk drive may contain one of any number of volumes (disks).

**volume bit map:** A portion of every ProDOS 16-formatted disk that keeps track of free disk space.

**volume control block (VCB):** A data structure set up in memory by ProDOS 16 to keep track of all volumes/devices connected to the computer.

**volume directory:** A ProDOS 16 directory file that is the principal directory of a volume. It has the same name as the volume. The pathname of every file on the volume starts with the volume directory name.

**volume name:** The name by which a particular volume is identified. It is the same as the filename of the **volume directory** file.

**word:** A group of bits that is treated as a unit. For the Apple IIGS, a word is 16 bits (2 bytes) long.

**zero page:** The first page (256 bytes) of memory in a standard Apple II computer (or in the Apple IIGS computer when running a standard Apple II program). Because the high-order byte of any address in this part of memory is zero, only a single byte is needed to specify a zero-page address. Compare **direct page**.



# Index

- A**
- absolute code 188
  - absolute segment. *See* segment(s)
  - access attribute 14, 21, 258, 260, 264, 277
    - backup bit 134, 277
    - write-enable bit 137
  - accessing. *See* device(s); disks
  - accumulator 77–78, 104, 209, 213
  - addresses. *See* memory; direct page and stack
  - alignment factor 299. *See also* segment(s)
  - ALIGN segment header field 186, 299. *See also* headers; segment(s)
  - ALLOC\_INTERRUPT call 48, 80, 94, 288
    - description of 175–176
  - Apple computers xx, 4. *See also specific computer*
  - Apple Desktop Interface 90–91
  - AppleTalk Personal Network 65
  - Apple II *See also* Apple II, standard
    - definition of xx
    - operating systems 281–288
    - zero page 75, 88
  - Apple II, standard 182
    - definition of xx
    - software for 34
  - Apple IIc 34
  - Apple IIe 34
  - Apple IIGS. *See also* ProDOS 8; ProDOS 16; manuals *or specific topic*
    - default operating system 13
    - description of 4
    - logical diagram of 6
    - memory 9, 32–40. *See also* memory
    - programming levels in 5–7
    - system disks 52–55. *See also* system disks
  - Apple IIGS Programmer's Workshop xx, xviii, 70, 89–90. *See also* programming
    - File Type utility 89
    - Linker 70, 89
    - Shell 82, 89, 208
  - Apple IIGS Toolbox xix, 6, 9
  - Apple II operating systems 281–288. *See also* operating system(s) *or specific operating system*
  - application(s) 58, 74–75
    - Apple IIGS Programmer's Workshop and 89
  - as controlling programs 184, 208. *See also* controlling programs
  - definition of 74
  - dormant 185, 225, 233, 246. *See also* System Loader
  - event-driven and segmented xix
  - loading 5, 71, 82–83, 89. *See also* System Loader
  - memory and 33, 39–40. *See also* memory
  - prefixes. *See* pathname prefixes
  - programming requirements for 74–75
  - quitting 59–65. *See also* PQUIT; QUIT call
  - reloading 71, 168
  - restarting 62, 71, 77, 168, 209–210, 233, 240, 245
    - See also* Restart call; System Loader
  - revising ProDOS 8 for ProDOS 16 86–89
  - shell 208
  - shutting down 209–210
  - starting 62, 64, 58–65, 167, 222
    - machine configuration at launch 64, 81
  - Application Shutdown call (System Loader) 77
  - application system disks. *See* system disks
  - APW. *See* Apple IIGS Programmer's Workshop
  - A register. *See* accumulator
  - ASCII character set 292–293
  - Assembler (APW) 89
  - assemblers, macro libraries and xv
  - assembling 89
  - assembly language xv, xviii
    - labels, typographic convention for xxi
  - AuxID. *See* User ID
  - auxiliary type 279–280
- B**
- backup bit 134, 277
  - banks, memory. *See* memory banks



BANKSIZE segment header field  
186, 299. *See also* headers;  
segment(s)  
bank-switched memory. *See*  
memory  
BASIC interpreter (BASIC.  
SYSTEM) 25, 34  
binary file (ProDOS 8) 12, 224,  
283  
bit map, volume. *See* volume bit  
map  
block devices 9, 14, 42-43, 84.  
*See also* device(s)  
blocks. *See* call blocks; file blocks;  
file control block; memory  
blocks; parameter blocks;  
volume control blocks  
boot initialization. *See* system  
startup  
boot prefix 65, 67, 167  
bootstrap errors. *See* errors  
buffers  
display 33  
I/O 14, 21-22, 24-25, 137.  
*See also* input/output  
busy error. *See* errors  
busy flag 36, 96  
Busy word (Scheduler) 71, 96  
byte(s)  
locating in files 274-275  
size of 33

## C

call blocks 89, 100-101, 213  
calling program (caller) 100, 213  
calls. *See* Exerciser; Memory  
Manager; parameter(s); ProDOS  
8; registers; system calls; tool  
calls *or* specific call  
capitalization 18  
cards. *See* 80-column card;  
language card  
cataloging disks xv, 26, 278-279  
C Compiler (APW) 89  
CHANGE\_PATH call 11-12, 21,  
257, 260, 262, 286  
description of 117-118  
character devices 9, 43. *See also*  
device(s)

character I/O 6. *See also*  
input/output  
cINTERSEG records 187, 298  
Cleanup call (System Loader) 227,  
231, 245  
description of 249-250  
CLEAR\_BACKUP\_BIT call 12, 260,  
264, 277  
description of 134  
CLOSE call 21, 24-25, 151-152,  
264, 277  
description of 145  
closing files. *See* file(s)  
communication ports 9, 43  
communications programs 83  
compaction 38  
compatibility, software 4, 10-11.  
*See also* ProDOS 8 and ProDOS  
16  
compiler. *See* C Compiler  
compiling 89  
configuration  
hardware, ProDOS 8 and ProDOS  
16 87  
setting initial 64, 81. *See also*  
programming  
control blocks. *See* file control  
blocks; volume control blocks  
controlling programs 71, 82, 184,  
204, 207-210, 213, 222,  
224-225, 240, 244, 249. *See*  
*also* application(s); System  
Loader  
designing 207-209  
Control Panel settings 46  
Control-Reset 25  
converting programs. *See* ProDOS  
8 and ProDOS 16  
copying  
files 84-85  
sparse files 30, 86  
CPUs. *See* 6502; 65C816  
CREATE call 21, 85, 103, 277, 287  
description of 111-114  
creating files. *See* file(s)  
creation date and time 14, 21,  
84-86, 119, 258, 260, 263,  
276. *See also* modification  
date and time; programming  
creation field 276

CRELOC records 187, 297

## D

data bank register 104  
data blocks. *See* file blocks  
dates. *See* creation date and time;  
modification date and time  
DB register. *See* data bank register  
DEALLOC\_INTERRUPT call 48, 95,  
177  
description of 175  
debuggers 61, 89  
deleting files. *See* file(s)  
dereferencing. *See* memory  
handles  
desk accessories 52-54, 170  
files 53-54  
User ID and 71  
DESTROY call 21, 115-116  
development environment. *See*  
Apple IIGs Programmer's  
Workshop  
device(s) 8, 42-46. *See also*  
interrupt(s); system calls *or*  
specific device  
accessing 43-45, 84. *See also*  
programming  
block 9, 14, 42-43, 84  
block read and block write 44-45  
character 9, 43  
definition of 42  
formatting disks. *See* disks  
input 42-43  
input/output 42  
interrupt-handling and 47-49.  
*See also* interrupt handlers  
last-accessed 44  
named 7, 10, 43-46, 84, 128  
numbers 45, 155  
online, number supported 45  
output 42-43  
sequential-access 43  
volume control blocks and 47.  
*See also* volume(s)  
device calls. *See* system calls  
device drivers 43, 254  
device-independence 91



- device search at system startup 45-46. *See also* system startup
  - dictionaries. *See* relocation dictionaries
  - directories. *See* directory files; file directory entry; subdirectories; volume(s)
  - directory files 26-27, 255-266
    - format and organization of 26-27, 255-266
    - file entries 261-264
    - pointer fields 256
    - subdirectory headers 259-261
    - volume directory headers 256
  - reading 265-266
  - directory headers, volume 256-259. *See also* volume(s)
  - direct page, definition of 75. *See also* zero page
  - direct page and stack 64, 75-79, 200-201. *See also* stack(s)
    - addresses 75, 77, 200-201
    - allocation at run time 77-78
    - automatic allocation of 75-76
    - default allocation 78
    - definition during program development 76
  - direct-page/stack segments 76, 78, 186, 224. *See also* segment(s)
  - direct register 70, 77-79, 104
    - hardware stack 75
    - introduction to 75-79
    - manual allocation of 78-79
    - ProDOS 16 default 78
  - direct register 70, 77-79, 194. *See also* registers
  - disk drives 43, 46, 56. *See also* device(s)
    - recommended number of xviii
    - type and location of 7
  - disk port xix, 45
  - disks 7-8, 52-55. *See also* system disks
    - accessing 5
    - cataloging xv, 26, 278-279
    - DOS 3.3, reading 284
    - formatting 14, 45. *See also* FORMAT call
    - integrity, damaging 25
    - partitioned 111
    - RAM 43
  - disk-switched errors. *See* errors
  - Disk II 43, 46
  - dispatcher. *See* interrupt dispatcher
  - display, high-resolution. *See* high-resolution display
  - display buffers 33. *See also* buffers
  - DisposeHandle call (Memory Manager) 79
  - disposing. *See* memory blocks
  - dormant state. *See* application(s); System Loader
  - DO\$. *See also* operating system(s)
    - file system 284
    - filing calls 286
    - history of 281-282
    - I/O 285
    - interrupt support 288
    - memory management 287
  - DOS 3.3 disks, reading 284
  - D register. *See* direct register
  - drivers, device. *See* device drivers
  - DS records 187, 297
  - dynamic segments. *See* segment(s)
- E**
- Editor (APW) 89
  - e-flag 64
  - 8-bit mode. *See* emulation mode
  - 80-column card 34
  - emulation mode 4, 9, 47, 100. *See also* programming
  - end of file. *See* EOF
  - END record 298
  - enhanced QUIT call (ProDOS 8) 60-61
  - entry, file. *See* file directory entry
  - entry points xxi, 35, 100, 213, 300
  - environment calls. *See* system calls
  - EOF (end of file) 21-24, 26, 30, 143, 147-150, 263, 269, 272-273. *See also* file(s)
    - maximum value 269
    - sparse files 273
- F**
- errors 302-311
    - bootstrap (ProDOS 16) 309
    - disk-switched 304
    - fatal 307-308; 311
    - nonfatal 302-307; 310
    - "ProDOS is busy" 83, 96
  - event-driven programming xix
  - events, handling 7
  - Exerciser, ProDOS 16 xviii, 54, 106, 289-294
    - calls and 106
    - commands 291-294. *See also specific command*
    - starting 289
    - system calls and 290
  - Exit to Monitor command (Exerciser) 293-294
  - expansion card ROM. *See* ROM
  - expansion memory. *See* memory
  - expansion slots 45-46
  - extended 80-column card. *See* 80-column card
  - external devices. *See* device(s)

- creation date and time 14, 21, 84-86, 119, 258, 260, 263
  - definition of 7
  - deleting 21, 85
  - desk accessory 53-54
  - directory. *See* directory files
  - directory entry. *See* file directory entry
  - end of (EOF) 21-24, 26, 30, 143, 147-150, 263, 269, 272-273
    - introduction to 22-23
  - flushing 24-25, 146
  - format of 21, 26-30, 253
  - hierarchical relationships among 26
  - I/O buffer 21-22, 24, 137, 145.
    - See also* input/output
  - initialization 53-54
  - introduction to 18-30
  - levels. *See* system file level
  - load. *See* load files
  - locating bytes in 274-275
  - Mark 21-24, 26, 30, 143, 201-202, 273-274
    - introduction to 22-23
  - modification date and time 84-86, 264
  - names. *See* filenames
  - object 89
  - open, maximum number of 22, 137
  - opening 21-22, 133-138
  - organization 26-30, 253-280.
    - See also* fields; headers
  - pathnames. *See* pathname(s)
  - PRODOS 53, 55, 56-58
  - reading 21-22, 24, 272
    - directory files 256-266
  - reference numbers 21, 24-25, 137, 265
    - of zero 145, 152
  - relationship among (hierarchical) 8
  - renaming 21, 85
  - run-time library 193, 199, 200, 230
  - sapling 29, 262, 268, 270-271
  - seedling 29, 262, 268, 270
  - size of 14, 24, 269
  - source 75, 89
  - sparse xv, 14, 30, 86, 253, 273-274
  - standard 26-27, 254, 267, 270
    - format and organization of 267
    - locating a byte in a file 274-275
    - reading 141-142, 272
  - START 58, 61-62
  - structure of 20, 26
  - subdirectory. *See* subdirectories
  - system 10, 12, 14, 18
  - TOOL.SETUP 53, 56
  - transferring data to and from 21
  - tree 29, 262, 271-272
    - .growing 267-269
  - types. *See* file types
  - using 18-25
    - volume directory. *See* volume(s)
    - writing 24, 143-144
  - file access calls 136-152. *See also specific call*
  - file blocks 26-29
    - block read and block write 44
    - data 28, 267, 270-271, 274
    - index 28, 267, 270, 271
    - key 254-255, 270, 272
    - master index 28, 260, 271
    - organization of directory files 28
    - size of 33
    - sparse files and 30
  - file control block 22, 24, 145
  - file directory entry 7, 25-26, 84, 261-264, 266
  - file entry field. *See* fields
  - file housekeeping calls 110-134.
    - See also specific call*
  - File Mark. *See* Mark
  - filenames
    - extensions 58, 74
    - number of characters in 14
    - requirements of 18
    - typographic convention for xxi
  - file system(s). *See also specific operating system*
  - guest 102
  - ID 45
  - version number 263, 305
  - file type attribute field 263, 278-279
  - file types 263, 278-279
    - \$06 12, 224
    - \$B3 58, 64, 74, 81, 89
    - \$B3-\$BE 12, 83, 224, 229
    - \$B4 230
    - \$B5 64, 209
    - \$B6 54, 56
    - \$B7 54, 56
    - \$B8 54, 56
    - \$B9 54, 56
    - \$FF 12, 56, 58, 83, 224
    - listing of 278-279
  - File Type utility (APW) 89
  - filing calls
    - Apple II operating systems 286-287
    - ProDOS 16. *See* system calls or *specific call*
  - finder 207-208
  - FindHandle call (Memory Manager) 79
  - firmware 6, 70-72
  - 5.25-inch disk drives 46
  - flag word 168, 245
  - flags
    - busy 36, 96
    - e-, m-, and x-flags 64
    - Jump-Table-Loaded 201, 235
    - quit 245
    - return 61, 82, 168
  - FLUSH call 24-25, 146
  - flushing files 24-25, 146
  - fonts 52
  - FORMAT call 12, 14, 42, 44-45, 155, 290
    - description of 160-161
  - formatting. *See* disks; FORMAT call; volume(s)
  - function names, typographic convention for xxi
- G**
- games 83
  - GET\_BOOT\_VOL call 12, 67, 133
    - description of 166
  - GET\_DEV\_NUM call 12, 42, 44-45
    - description of 155
  - GET\_EOF call 23, 286
    - description of 150

GET\_FILE\_INFO call 21, 85–86, 123–127  
GET\_LAST\_DEV call 12, 42, 44  
description of 156  
GET\_LEVEL call 12, 25, 80, 145  
description of 152  
Get Load Segment Info call  
(System Loader) 206, 238–239  
GET\_MARK call 23, 148  
GET\_NAME call 12, 23, 67, 148  
description of 165  
Get Pathname call (System Loader)  
242–243  
GET\_PREFIX call 20, 66, 165  
description of 133  
Get User ID call (System Loader)  
240–241  
GET\_VERSION call 12, 80, 258, 260, 264, 258  
description of 171  
global page (ProDOS 8) 10, 36  
Apple IIGs equivalents to 80  
global variables 79, 300. *See also*  
programming; System Loader  
graphic design 91

## H

halting current program (Control-Reset) 25  
handlers, interrupt. *See* interrupt handlers  
handles. *See* memory handles  
hardware  
configuration 87  
interrupts. *See* interrupt(s)  
registers 64  
requirements for ProDOS 16  
xviii–xix  
stack 75  
header fields. *See* fields; headers; segment(s)  
headers  
directory 256–259. *See also*  
volume(s)  
segment 186, 299. *See also*  
segment(s)  
subdirectory 259–261. *See also*  
subdirectories

hierarchical file system 7, 283  
high-resolution display, memory  
banks for 33  
Human Interface Guidelines  
90–91. *See also* programming

## I

ID  
file system. *See* file system(s)  
User. *See* User ID  
index blocks. *See* file blocks  
initialization. *See* system startup;  
register(s)  
initialization files 53–54. *See also*  
file(s)  
initialization segments 224, 184  
initializing. *See* disks; registers;  
volume(s)  
Initial Load call (System Loader)  
222–224, 227, 240  
input devices, definition of 42.  
*See also* device(s)  
input/output  
buffers 14, 21–22, 24–25, 34, 137. *See also* buffers; file(s)  
character 6  
memory 33, 64. *See also*  
memory  
similarity among operating  
systems 285  
space in RAM 33  
standard 64, 209  
subroutines xix, 70  
input/output devices, definition of  
42. *See also* device(s)  
interface, human 90–91  
interpreter. *See* BASIC interpreter  
interrupt(s)  
allocating and deallocating 95  
disabling 81, 100  
handling. *See* interrupt handlers  
number of interrupting devices  
handled 9  
priority rankings 48  
support of, similarity among  
operating systems 288  
system calls during 96  
table. *See* interrupt vector table  
unclaimed 49, 83, 95

using 83. *See also* programming  
interrupt control calls. *See* system  
calls *or specific call*  
interrupt dispatcher 95  
interrupt handlers xv, 5–6, 9, 15,  
47–49, 74, 83, 94–96, 167,  
175, 177  
conventions 94  
converting ProDOS 8 to  
ProDOS 16 88  
deallocating 167  
installing 95  
introduction to 94–96  
modifying 88  
number supported (user-installed)  
48  
Scheduler and 71  
system calls during 96  
Interrupt Request Line 49  
interrupt routines. *See* interrupt  
handlers  
interrupt vector table 95, 175, 177  
INTERSEG records 187, 189,  
195–196, 297  
I/O. *See* input/output  
IRQ. *See* Interrupt Request Line

## J

joysticks 42  
Jump Table. *See* System Loader  
data tables  
Jump Table Load call (System  
Loader) 195–196, 213  
description of 247–248  
Jump-Table-Loaded flag 201, 235

## K

kernel 5  
key block. *See* file blocks  
keyboard 42–43  
key combinations. *See* Control-Reset  
KIND segment header field 186,  
193, 224, 296. *See also*  
headers; segment(s)



**L**

language-card area in memory 34, 64  
 launching. *See* application(s)  
 LCONST records 187, 297  
 libraries  
   run-time 193, 199–200, 205–206  
   subroutine 70, 80  
 library prefixes. *See* pathname prefixes  
 Linker (APW) 89  
 linkers 76, 89, 189  
 List Directory command (Exerciser) 291  
 listings, catalog. *See* cataloging disks  
 load, initial 183–194, 205, 222–224, 240. *See also* System Loader  
 Loader Initialization call (System Loader) 215  
 Loader Reset call (System Loader) 220  
 Loader Shutdown call (System Loader) 217  
 Loader Startup call (System Loader) 216  
 Loader Status call (System Loader) 221  
 Loader Version call (System Loader) 218–219  
 load files 183, 193, 205, 229, 298. *See also* file(s)  
 Load Segment By Name call (System Loader) 206, 234–236  
 Load Segment By Number call (System Loader) 206, 224, 235  
   description of 228–229  
 load segments. *See* segment(s); System Loader  
 loading. *See* application(s); System Loader  
 locked blocks. *See* memory blocks  
 long word, size of 33, 102  
 lowercase letters 18

**M**

machine configuration. *See* configuration  
 Macintosh computer 90  
 macros xv, 6  
   calls 213  
 Main ID. *See* User ID  
 manuals xv–xvii, xix–xx  
   *Apple Numerics Manual* xvi–xvii  
   *Apple IIc Technical Reference Manual* 34  
   *Apple IIgs Firmware Reference* xvi–xvii, xix, 9, 43, 47, 95  
   *Apple IIgs Hardware Reference* xvi–xvii, 33–34  
   *Apple IIgs ProDOS 16 Reference* xvi–xvii  
   *Apple IIgs Programmer's Workshop Assembler Reference* xvi–xviii, xx, 90  
   *Apple IIgs Programmer's Workshop C Reference* xvi–xvii, xx, 90  
   *Apple IIgs Programmer's Workshop Reference* xvi–xvii, xx, 9, 70  
   *Apple IIgs Toolbox Reference* xvi–xvii, xix, 8–9, 34, 36, 40, 43, 49, 70–72, 78, 82–83, 96, 300  
   *Human Interface Guidelines* xvi–xvii, 90–91  
   *ProDOS 8 Technical Reference Manual* xvi–xviii, xx, 5, 66  
   *Programmer's Introduction to the Apple IIgs* xvi–xvii, xix, 40, 81  
   *Technical Introduction to the Apple IIgs* xvii–xvii, xix, 4, 33, 100  
 Mark 21–24, 26, 30, 143, 201–202, 273–274. *See also* file(s)  
 master index blocks. *See* file blocks  
 master pointers. *See* pointer(s)  
 memory 6, 8, 32–40. *See also* RAM; ROM  
   addressable, total 9, 32

addresses 34, 36–37, 82, 124.  
   *See also* addresses; pointer(s)  
 allocation of 82. *See also* programming  
 banks. *See* memory banks  
 bank-switched 33–34  
 blocks. *See* memory blocks  
 compaction 38  
 configurations 32–36  
 conserving space 22  
 entry points and fixed locations 35–36  
 expansion 33  
 handles. *See* memory handles  
 I/O. *See* input/output  
 language-card areas 34, 64  
 management. *See* memory management; Memory Manager  
 map 32, 35  
 movable 82. *See also* memory blocks  
   non-special 54  
   obtaining (applications) 39–40  
   requesting 39–40  
   requirements of ProDOS 16 xviii  
   reserved 64  
   shadowing 34, 64  
   special 34, 37, 62, 78, 224  
   units, size of 33  
   video 33–34  
 memory banks 33–36  
   \$00 33–34, 47, 56, 61, 64, 68, 75, 81, 88, 100, 105, 224  
   \$01 33–34, 64, 224  
   \$01–\$E1 64  
   \$E0 34  
   \$E1 34–36, 65, 105  
 memory blocks 26–29, 185. *See also* block devices; Memory Manager  
   absolute 40  
   addresses of 38  
   applications and 39  
   attributes of 37  
   disposing 38, 245  
   fixed (unmovable) 37, 40, 78–79, 82, 185–186  
   handles to. *See* memory handles  
   load-segment relationships (load time) 186

locked 37-38, 77-79, 184, 227  
manipulation of 37-38  
movable 185, 231  
pointers to 38-39, 82  
purgeable 37-38, 78-79,  
185-186, 277, 233  
size of 37  
unpurgeable 185-186, 277  
memory handles 38-40, 82, 102,  
194, 200, 214  
definition of 214  
dereferencing 39, 82, 104, 207  
introduction to 38-39  
length of (parameter fields) 106  
NIL 187, 192-193, 277  
memory management 10, 15,  
32-40, 38-39. *See also*  
Memory Manager  
how applications obtain memory  
39  
revising ProDOS 8 applications for  
ProDOS 16 86  
similarity among operating  
systems 287-288  
Memory Manager xix, 8, 32,  
36-37, 64, 74, 79, 82, 182,  
187, 205, 227, 231, 245, 287.  
*See also* memory mangement  
calls 207  
description of 36-37, 70  
interface with System Loader  
184-187  
memory blocks and 104, 185  
support for bank-alignment 300  
Memory Segment Table 184,  
187-189, 192-193, 206, 227,  
231, 238  
messages. *See* error messages  
m-flag 64  
microprocessors. *See* 6502;  
65C816  
Miscellaneous Tool Set. *See*  
System Failure Manager; User  
ID Manager  
modes, emulation and native 4, 9,  
47, 100  
modification date and time 84-86,  
264, 276. *See also* creation  
date and time; programming  
modification field 276

Modify Memory command  
(Exerciser) 291  
Monitor program xix, 281, 293

## N

named devices. *See* device(s)  
names. *See* device(s);  
pathname(s); filenames;  
volume(s)  
native mode 4, 9, 47, 100. *See*  
*also* programming  
NewHandle call (Memory Manager)  
79  
NEWLINE call (\$11) 137-140  
nibble, size of 33  
NIL handles. *See* memory handles  
numbers  
device. *See* device(s)  
pathname prefix. *See* pathname  
prefixes

## O

object files. *See* file(s)  
object module format 70, 74, 89,  
187, 230, 295  
object segments. *See* segment(s);  
direct page and stack  
OMF. *See* object module format  
ON\_LINE call (ProDOS 8) 88  
online devices. *See* device(s)  
OPEN call 21, 80, 151-152, 287  
description of 137-138  
operating environment 5, 52-72,  
164. *See also specific topic*  
operating system(s), Apple II,  
comparison of 281-288. *See*  
*also specific operating system*  
*or specific topic*  
calls. *See* system calls  
default at startup 13  
file compatibility 283-284  
reading DOS 3.3 and Apple II  
Pascal disks 284  
filing calls 286-287  
history of 281-282  
input/output 285  
interrupt support 288  
memory management 287

similarity of 285-288  
organization (files)  
block and tree 28  
definition of 253  
ORG segment header field 186.  
*See also* headers; segment(s)  
output devices, definition of 42.  
*See also* device(s)  
overflow, stack. *See* stack(s)  
overlays 205

## P

page, size of 33, 291. *See also*  
memory  
parameter(s) 102-104  
blocks. *See* parameter blocks  
fields 105  
format 102-103  
length of pointers and handles  
106  
order of bytes in a field 103  
order on stack 214  
permissible range of values 103,  
107  
pointers and 102-103, 106  
setting up in memory 103-104  
System Loader 213  
types of 102, 213  
parameter blocks 10, 81-82, 88,  
100-104  
Pascal operating system  
file system 284  
filing calls 287  
history of 283  
interrupt support 288  
I/O 285  
memory management 287  
reading Pascal disks 284  
Pascal strings 201  
patches. *See* RAM, Apple IIGs  
patching 188, 196  
pathname(s) 7, 19-21, 65-69,  
117, 199  
assigning 21  
full 19, 69, 201  
length of 20  
number of characters in 14  
partial 19, 65, 69, 168, 201, 241  
pointers 61, 82



- prefixes. *See* pathname prefixes
- requirements of 19
- segment 184, 199, 200, 298.
  - See also* segment(s)
- pathname prefixes 5, 14, 19–20, 65–69, 131
  - application 66–67, 165, 201
  - boot 65, 67, 166
  - code numbers of 20
  - default 65, 131
  - initial ProDOS 16 values 66
  - introduction to 65–69
  - library 66–67, 201
  - multiple 20
  - null 20
  - number of characters in 14
  - numbers 66–67, 81, 131, 168
  - partial pathnames 19
  - predefined 65
  - ProDOS 8 prefix and pathname conventions 68–69
  - samples of 66
  - storage of 66
  - system (ProDOS 8) 66, 69
  - values of 67–68
- Pathname Table 189, 196, 200–201, 206, 227, 245
- peripheral devices. *See* device(s)
- pointer(s) 26, 38–39. *See also* EOF; Mark; memory handles
  - definition of 102, 214
  - fields. *See* fields
  - length of (parameter fields) 106
  - master 38
  - order of bytes 256
  - parameter block 38–39, 82
  - pathname 61, 83
- port numbers 7
- ports
  - communication 9, 43
  - disk xix, 45
  - serial xix
- PQUIT 56, 59–62. *See also* QUIT call
  - ProDOS 8 QUIT calls, standard and enhanced 60
  - ProDOS 16 QUIT call 61
- prefixes, pathname. *See* pathname prefixes
- printers 9, 43
- print spoolers 83
- processor status register 64, 105
- ProDOS xxi, 282. *See also* operating system(s); ProDOS 8; ProDOS 16
  - ProDOS busy flag. *See* busy flag
  - PRODOS file 53, 55, 56–58
  - ProDOS 8 xviii, 5, 9–13, 52, 60–61, 170. *See also* manuals; operating system(s)
    - applications, memory banks for 33
    - binary files 12, 224, 283
    - description of xxi, 4
    - enhanced QUIT call 60–61
    - file system 283
    - filing calls 286
    - global page 10, 36, 79–80
    - history of 282
    - interrupt support 288
    - I/O 285
    - loading 166
    - memory and 34, 86–87
    - on an Apple IIGs vs. other Apple II computers 5
    - pathname of current application 69
    - prefix 68–69
    - quit type 60
    - standard QUIT call 60–61
    - system calls 9–11, 105
    - system disk 56
    - system file 12, 58, 182, 224
    - system prefix 66, 68
    - system program 12, 58, 182, 224
    - unit (device) number 84
  - ProDOS 8 and ProDOS16 9–10, 86–89, 105–106
    - call methods compared 105–106
    - calls, converting 88
    - compilation/assembly 89
    - downward compatibility 11
    - eliminated ProDOS 8 system calls 11
    - hardware configuration 87
    - interrupt handlers, modifying 88
    - memory management 86
    - new ProDOS 16 system calls 11
    - revising applications 86–89
  - stack and zero page, converting 88
  - upward compatibility 10–11
- “ProDOS is busy” error. *See* errors
- ProDOS 16 xxi, 4–15. *See also* manuals; operating system(s) or *specific topic*
  - adding routines to 94–97
  - bypassing 6
  - description of xxi, 4–15
  - errors 302–309. *See also* errors
  - external devices and 42–49
  - fixed locations 65
  - history of 283
  - interface to 89
  - introduction to 4–15
  - memory and xviii, 32–40
  - memory map 35
  - new system calls 12
  - ProDOS 8 and. *See* ProDOS 8 and ProDOS 16
  - summary of features 13–15
  - system calls. *See* system calls
  - version number 171
- ProDOS 16 Exerciser. *See* Exerciser
- program bank register. *See* registers
- program counter register. *See* registers
- Programmer’s Workshop. *See* Apple IIGs Programmer’s Workshop
- programming xix, 74–91. *See also* *specific topic*
  - application requirements 74
  - direct page and stack. *See* direct page and stack
  - event-driven xix
  - levels in Apple IIGs 5–7
  - segmented xix
  - suggestions for 74–91
    - System Loader 203–210
  - system resource management 79–84
- programs. *See* application(s); controlling programs; static programs
- publications. *See* manuals

purge levels 37, 77-78, 185-186, 231  
purgeable segments. *See* segment(s)

## Q

QUIT call (ProDOS 8), standard and enhanced 60-61  
QUIT call (ProDOS 16) 15, 59-61, 69, 74, 77, 82, 207, 209-210, 245. *See also* PQUIT  
description of 167-170  
return flag parameter 61, 82  
Quit command (Exerciser) 294  
quit flag 245  
QUIT procedure 62. *See also* QUIT call  
quit return stack 167. *See also* stack(s)  
quitting applications. *See* application(s)  
quit type (ProDOS 8) 60

## R

RAM (Apple IIc or IIe) 34  
RAM (Apple IIgs) 32. *See also* memory  
fixed entry points in 35  
I/O space in 33  
patches to ROM-based tool sets 52-53  
specialized areas in 33  
tool sets 33, 52  
RAM disks 43  
READ\_BLOCK call 42, 44, 284  
description of 157-158  
READ call 24, 42, 44, 85, 139  
description of 141-142  
reading  
directory files 265-266  
disks, DOS 3.3 and Pascal 284  
files 24, 272  
ReadTime call (Miscellaneous Tool Set) 80  
records 187, 231, 297  
CINTERSEG 187, 298  
CRELOC 187, 297  
DS 187, 297

END 298  
INTERSEG 187, 189, 195-196, 297  
LCONST 187, 297  
RELOC 187-188, 297  
SUPER 187, 298  
reference number (*ref\_num*). *See* file reference number  
registers 64, 224  
accumulator 77-78, 104, 209, 213  
data bank 104  
direct 70, 77-79, 104  
hardware 64  
initializing 81, 209  
processor status 64, 105  
program bank 104  
program counter 104  
stack pointer 75, 77-79, 104  
values on entry and exit from call 104, 213  
X register 64, 104, 208  
Y register 64, 104, 208  
reloading applications. *See* application(s)  
Reload segments. *See* segment(s)  
relocatable segments. *See* segment(s)  
relocation dictionaries 187-188, 195, 201  
RELOC records 187-188, 297  
RENAME call 277  
renaming files. *See* file(s)  
requests. *See* calls; system calls  
Restart call (System Loader) 201, 209  
description of 225-227  
restart-from-memory flag 168  
restarting. *See* application(s)  
result, definition of 102, 213  
return flag (QUIT call) 61, 82, 168  
revising ProDOS 8 applications for ProDOS 16 86-89. *See also* application(s); ProDOS 8 and ProDOS 16; programming  
ROM (Apple IIc or IIe) 34  
ROM (Apple IIgs) 32, 45-46. *See also* memory  
expansion card 45-46  
routines in xix, 6

tool sets 33, 52-53  
routines. *See also* interrupt handlers; libraries  
adding to ProDOS 16 93-97  
Apple IIgs Toolbox 9  
file-copying 84  
interrupt. *See* interrupt handlers  
library xv, 70, 80  
names of, typographic convention for xxi  
program selection (PQUIT) 59  
ROM xix, 6  
run-time libraries. *See* libraries

## S

sapling files 29, 262, 268, 270-271  
Scheduler 71, 96  
sectors 43, 254, 282, 284  
seedling files 29, 268, 270  
segment(s)  
absolute 182-183, 186  
alignment factor 299  
bank-aligned 299  
direct-page/stack 76, 78, 186, 224  
dynamic 182-183, 185-186, 193, 196, 204-205, 224, 228, 245  
header fields 186, 299  
initialization 184, 224, 227  
Jump Table. *See* System Loader  
KIND field 186, 193, 224, 296  
libraries 70, 79  
load 71, 76, 183, 185-186, 195, 230  
load numbers 298  
locking 207  
main 298  
Memory Segment Table. *See* System Loader data tables  
object 76  
page-aligned 299  
pathname 184, 199, 200, 298  
position-independent 183, 185, 186  
purgeable 77-78, 183, 185-186, 207, 231  
Reload 225, 227, 297

relocatable 182-183, 186-189  
run-time libraries 206  
static 15, 77, 183, 193, 204,  
224, 298  
unloading 207  
unlocked 207  
segmented programming xix  
sequential-access devices. *See*  
device(s)  
serial ports, routines for xix  
SET\_EOF call 23, 85  
description of 149  
SET\_FILE\_INFO call 21, 86, 124,  
260, 264, 277  
description of 119-122  
SET\_LEVEL call 12, 25, 145  
description of 151  
SET\_MARK call 23, 286  
description of 147  
SET\_PREFIX call 20, 66, 68, 165  
description of 131-133  
shadowing 34, 64. *See also*  
memory  
shadow register 64  
Shell (APW) 82, 89, 208  
shell applications 208  
shells 207, 222, 225. *See also*  
controlling programs  
shutting down. *See* application(s)  
65C816 assembly language. *See*  
assembly language  
6502 microprocessor 4, 9, 75  
16-bit mode. *See* native mode  
slashes, prefixes and 19  
slot numbers 7, 46. *See also*  
expansion slots  
slots. *See* expansion slots  
SmartPort 45-46  
soft switches, initializing 64, 81  
software. *See also* operating  
system(s); RAM disks; system  
disks; system software  
compatibility 4, 10-11. *See also*  
ProDOS 8 and ProDOS 16  
requirements xviii-xix  
standard Apple II 34  
SOS operating system  
file system 278, 284, 287  
filing calls 286  
history of 282

interrupt support 288  
I/O 285  
memory management 287  
source files 75. *See also* file(s)  
sparse files. *See* file(s)  
special memory. *See* memory  
S register (stack pointer). *See*  
registers  
stack(s). *See also* direct page and  
stack  
diagram format (System Loader  
calls) 214  
hardware 75  
locations, converting ProDOS 8 to  
ProDOS 16 88  
overflow 77  
pointer 75, 77-79, 104  
quit return stack 167  
standard Apple II. *See* Apple II,  
standard  
standard file 26-27, 270. *See*  
*also* file(s)  
format and organization of 267  
reading 272  
standard I/O. *See* input/output  
standard QUIT call (ProDOS 8)  
60-61  
START file 58, 61-62  
startup. *See* application(s); system  
startup  
static programs 77, 204. *See also*  
System Loader  
static segments. *See* segment(s)  
status register 105  
storage devices. *See* device(s)  
storage type field 275  
subdirectories 7, 26, 53-54, 56.  
*See also* directories  
file entry and 84  
files 254  
headers 259-261  
library 80  
subroutines. *See* routines  
SUPER records 187, 298  
switchers 207, 222, 225  
system calls xix, 9-13, 94,  
98-177. *See also* calls or  
*specific call*  
call block 100

converting ProDOS 8 to  
ProDOS 16 88  
definition of 100  
description format 106-107  
device calls 154-162  
environment calls 164-171  
Exerciser disk and 290  
file access calls 136-152  
file housekeeping calls 110-134  
filing calls. *See* file access calls;  
file housekeeping calls  
interrupt control calls 174-177  
interrupt handlers and 96  
parameter blocks 100-103. *See*  
*also* parameter(s)  
practicing with Exerciser 290  
ProDOS 8 11, 105  
ProDOS 16 (new) 12  
register values on entry and exit  
from 104  
system call reference 98-177  
system disks xix, 52-55. *See also*  
disks; system startup  
application 52, 54-55  
complete 52-53  
standard Apple II 55-56, 69  
System Failure Manager 49, 72, 83  
system file (ProDOS 8) 12, 58,  
182, 224  
system file level 25, 80, 145,  
151-152, 167  
System Loader 33-35, 37, 52, 56,  
63, 77-78, 181-301. *See also*  
records  
calls. *See* System Loader calls or  
*specific call*  
controlling program design and  
207-209. *See also* controlling  
programs  
data tables. *See* System Loader  
data tables  
description of 70, 182-183  
dormant state 62, 168, 185,  
225, 233, 246  
dynamic segments and 204-205.  
*See also* segment(s)  
entry point 35, 300  
errors 310-311  
functions (categorized by caller)  
210



global variables 300  
 interface with Memory Manager 184–187  
 introduction to 70, 182–189  
 load-file structure 187  
 loading relocatable segments 187–189  
 memory map of 34–35  
 memory requirements of xviii  
 parameters 213–214  
 programming with 203–210  
 reference for xix  
 relocation 188–189  
 restarting and shutting down applications 209–210  
 run-time libraries and 205–206  
 segment loading, user control of 206–207. *See also* segment(s)  
 static programs and 204  
 technical data 295–301  
 terminology 183–184  
 version number 218–219

System Loader calls 210–250. *See also specific call*  
 call block 213  
 categories of 210  
 description format 214  
 how calls are made 213  
 parameter types 213–214. *See also* memory blocks; parameter(s)

System Loader data tables 192–202

Jump Table 189, 193–198, 233  
 Jump Table Directory 193–194, 196  
 diagram of 198  
 directory entry 194  
 modification at load time 196  
 Jump Table Load call 195–196, 213, 247–248  
 Jump-Table-Loaded flag 201, 235  
 segment entry 194–197, 237  
 segments 201, 298, 193–195. *See also* segment(s)  
 use during execution 196–197

Mark List 201–202

**memory segment table**  
 192–193. *See also* segment(s)

Pathname Table 199–201  
 system prefix (ProDOS 8) 66, 68–69  
 system program (ProDOS 8) 12, 58, 182, 224  
 system resources, managing 79–84  
 system software 70–72. *See also* system disks; software memory banks and 33 User ID and 71

system startup 55–59, 210  
 boot initialization 52, 56–57  
 default operating system 13  
 device search 45–46  
 • introduction to 55–59  
 Loader initialization 215  
 program selection 58–59  
 rebooting 49

**T**

tables. *See* interrupt vector table; System Loader data tables

time. *See* creation date and time; modification date and time

toolbox. *See* Apple IIGs Toolbox

tool calls 6–7. *See also specific tool*

tools xix, 70–72, 182. *See also* RAM-based tools; ROM-based tools *or specific tool*

TOOL.SETUP file 53, 56

tracks 43, 254, 282, 284

transferring  
 data to and from files 21  
 sparse files 30

tree files 28, 29, 262, 271–272  
 growing 267–269

TypeID. *See* User ID

**U**

unclaimed interrupts. *See* interrupt(s)

UniDisk 3.5 43

Unload Segment By Number call (System Loader) 207, 237  
 description of 232–233

uppercase letters 18

User ID 37, 61, 71, 77, 167–168, 186, 192, 194–195, 200, 206, 208, 209, 223, 226–227, 230, 233, 240, 245. *See also* Memory Manager; User ID Manager

AuxID 301  
 format 300–301  
 MainID 208, 223, 301  
 TypeID 71, 223, 301

User ID Manager 71, 184, 300–301

User Shutdown call (System Loader) 185, 209, 225  
 description of 244–246

**V**

value, definition of 102, 213

variables, global. *See* global variables

VCB. *See* volume control blocks

vectors. *See* interrupt vector table

vector space values 64

version numbers  
 file system 258, 260, 263, 305  
 object module format 230  
 ProDOS 16 171  
 System Loader 218–219

video memory. *See* memory

volume(s) 7–8. *See also* file(s)  
 boot 81  
 directories 7, 18, 254  
 directory headers 256–259  
 formatting 254  
 names 7, 14, 18, 43, 117  
 organization of information on 254–255  
 sizes of 14  
 volume bit map 254, 258

VOLUME call 11, 44, 80  
 description of 128–130

volume control blocks 47

**W**

word, size of 33, 102. *See also* long word

WRITE\_BLOCK call 42, 44, 284, 290  
 description of 159

WRITE call 24, 42, 44, 85, 264, 277  
description of 143-144  
write-enable bit 137  
writing  
applications 89  
files 24

### **X-Y-Z**

x flag 64  
X register 64, 104, 208  
Y register 64, 104, 208  
zero page 75, 88. *See also* direct  
page



# ProDOS 16 Calls

Call Block:  
 JSL PRODOS  
 DC 12 'CALLNUM'  
 DC 14 'PARMBLOCK'  
 BCS ERROR

PRODOS entry point  
 = \$E1 00A8

*Each minor division in a parameter block diagram represents one byte*

## \$01 CREATE

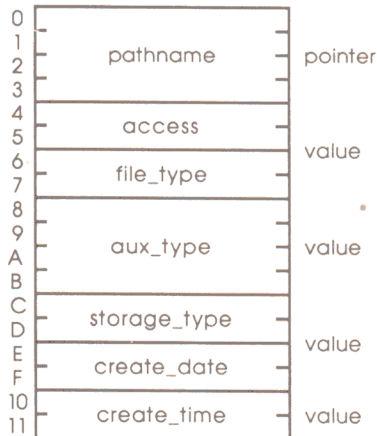

## \$02 DESTROY



## \$04 CHANGE\_PATH

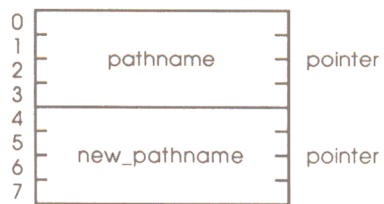

## \$05 SET\_FILE\_INFO

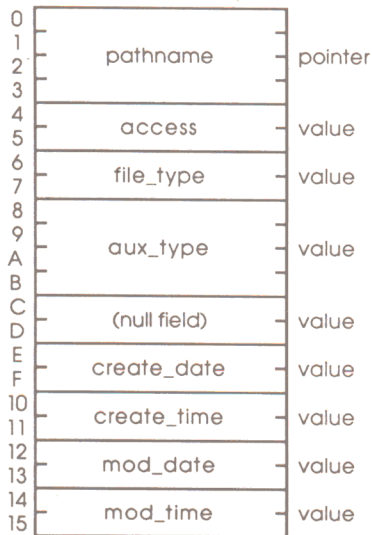

## \$06 GET\_FILE\_INFO

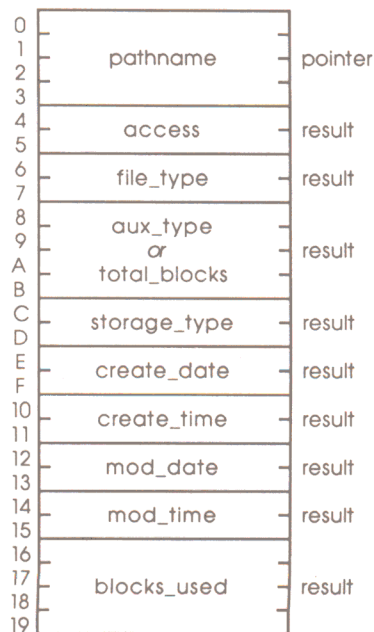

## \$08 VOLUME

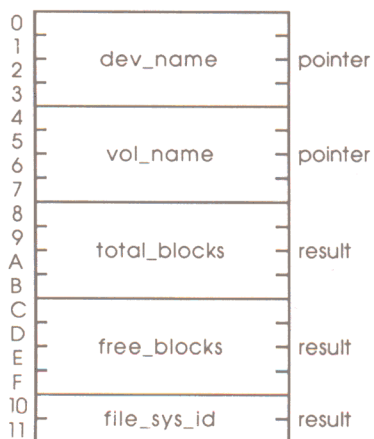

**\$09**  
**SET\_PREFIX**

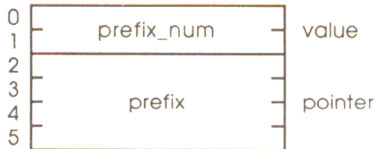

**\$0A**  
**GET\_PREFIX**

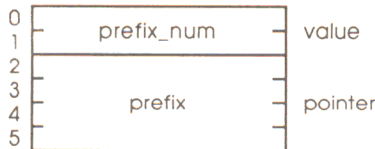

**\$0B**  
**CLEAR\_BACKUP\_BIT**



**\$10**  
**OPEN**

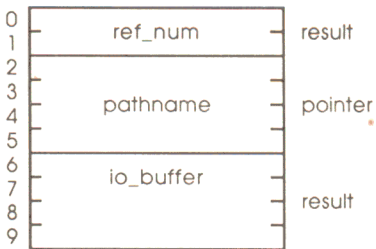

**\$11**  
**NEWLINE**

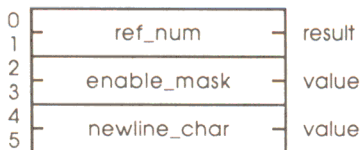

**\$12**  
**READ**

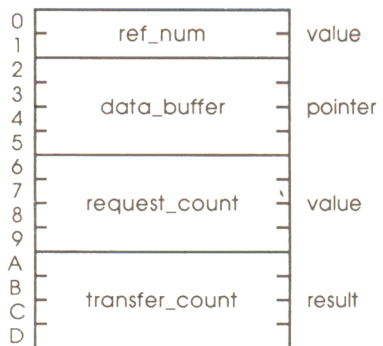

**\$13**  
**WRITE**

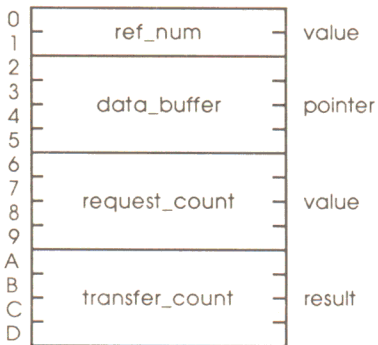

**\$14**  
**CLOSE**

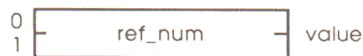

**\$15**  
**FLUSH**



**\$16**  
**SET\_MARK**

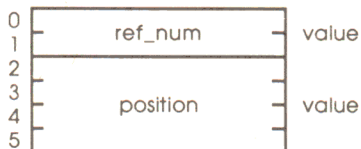

**\$17**  
**GET\_MARK**

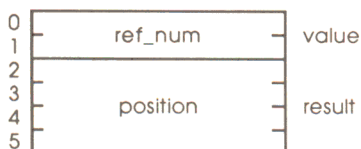

**\$18**  
**SET\_EOF**

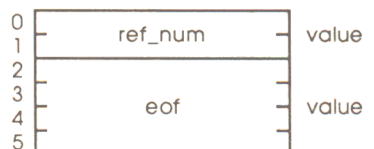

P\_BIT



**\$19**  
**GET\_EOF**

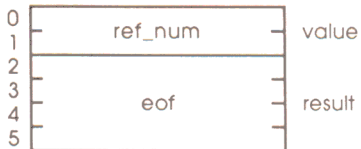

**\$1A**  
**SET\_LEVEL**



**\$1B**  
**GET\_LEVEL**



**\$20**  
**GET\_DEV\_NUM**

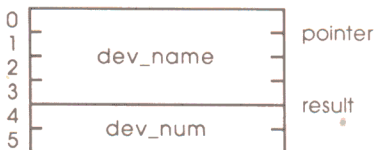

**\$21**  
**GET\_LAST\_DEV**



**\$22**  
**READ\_BLOCK**

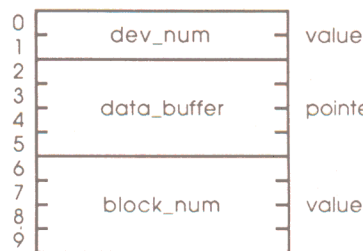

**\$23**  
**WRITE\_BLOCK**

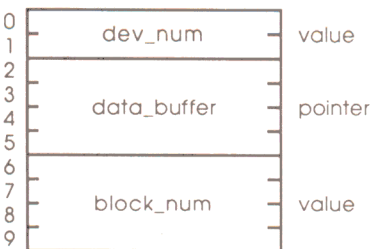

**\$24**  
**FORMAT**

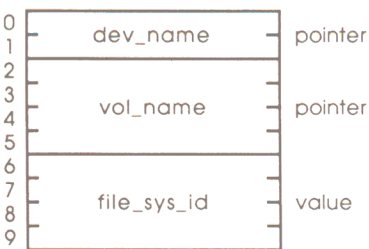

**\$27**  
**GET\_NAME**

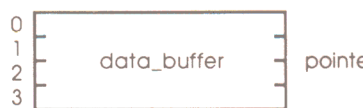

**\$28**  
**GET\_BOOT\_VOL**



**\$29**  
**QUIT**



**\$2A**  
**GET\_VERSION**



**\$31**  
**ALLOC\_INTERRUPT**

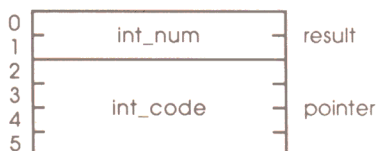

**\$32**  
**DEALLOC\_INTERRUPT**



# Fields

## Access Byte

Bit:	7	6	5	4	3	2	1	0
Value:	D	RN	B	reserved	W	R		

D = destroy-enable bit  
 RN = rename-enable bit  
 B = backup-needed bit  
 W = write-enable bit  
 R = read-enable bit

## Creation/Modification Date

	Byte 1						Byte 0									
Bit:	15	14	13	12	11	10	9	8	7	6	5	4	3	2	1	0
Value:	Year						Month			Day						

## Creation/Modification Time

	Byte 1						Byte 0									
Bit:	15	14	13	12	11	10	9	8	7	6	5	4	3	2	1	0
Value:	0	0	0	Hour			0	0	Minute							

## Version Word

	Byte 1						Byte 0									
Bit:	15	14	13	12	11	10	9	8	7	6	5	4	3	2	1	0
Value:	B	Major Release No.						Minor Release No.								

B = 0 for final releases  
 B = 1 for prototype releases

## File Mark

	Byte 2						Byte 1						Byte 0											
Bit:	7	6	5	4	3	2	1	0	7	6	5	4	3	2	1	0	7	6	5	4	3	2	1	0
Value:	Index Block No.						Data Block Number						Byte of Block											

Applies to: Tree File only      Tree and Sapling      All Three

## Segment KIND

	Byte 1								Byte 0							
Bit:	15	14	13	12	11	10	9	8	7	6	5	4	3	2	1	0
Value:	SD	Pr	PI	SM	AB	R	(reserved)				Type					

**SD** = 1: segment is dynamic  
**Pr** = 1: segment is private  
**PI** = 1: segment is position-independent  
**SM** = 1: segment may not be in special memory  
**AB** = 1: segment is absolute-bank  
**R** = 1: segment is a Reload segment

Type	Description
\$00	code segment
\$01	data segment
\$02	Jump Table segment
\$04	Pathname segment
\$08	library dictionary segment
\$10	initialization segment
\$12	direct-page/stack segment

## User ID Word

	Byte 1						Byte 0									
Bit:	15	14	13	12	11	10	9	8	7	6	5	4	3	2	1	0
Value:	Type ID			Aux ID			Main ID									

TypeID	Description
\$0	Memory Manager
\$1	application
\$2	controlling program
\$3	ProDOS 8 and ProDOS 16
\$4	tool set <sup>†</sup>
\$5	desk accessory
\$6	run-time library
\$7	System Loader
\$8	firmware/system function
\$9	Tool Locator
\$A-\$F	(undefined)

<sup>†</sup> if TypeID = \$04, these values of AuxID are reserved:

\$1	Miscellaneous toolset file
\$2	Scrap Manager file
\$A	tool setup file

# Error Codes, Files, and Records

## ProDOS 16 Error Codes

### Nonfatal:

\$01	Invalid call number
\$07	ProDOS is busy
\$10	Device not found
\$11	Invalid device request
\$25	Interrupt vector table full
\$27	I/O error
\$28	No device connected
\$2B	Write-protected
\$2D	Invalid block address
\$2E	Disk switched
\$2F	Device not on line
\$30 - \$3F	Device-specific errors
\$40	Invalid pathname/device name syntax
\$42	FCB table full
\$43	Invalid file reference number
\$44	Path not found
\$45	Volume not found
\$46	File not found
\$47	Duplicate pathname
\$48	Volume full
\$49	Volume directory full
\$4A	Version error (incompatible file format)
\$4B	Unsupported (or incorrect) storage type
\$4C	End-of-file encountered (out of data)
\$4D	Position out of range
\$4E	Access not allowed
\$50	File is open
\$51	Directory structure damaged
\$52	Unsupported volume type
\$53	Parameter out of range
\$54	Out of memory
\$55	VCB table full
\$57	Duplicate volume
\$58	Not a block device
\$59	Invalid level
\$5A	Block number out of range
\$5B	Illegal pathname change
\$5C	Not an executable file
\$5D	Operating system/file system not available
\$5E	Cannot deallocate /RAM
\$5F	Return stack overflow
\$60	Data unavailable

### Fatal:

\$01	Unclaimed interrupt
\$0A	VCB unusable
\$0B	FCB unusable
\$0C	Block zero allocated illegally
\$0D	Interrupt occurred while I/O shadowing off
\$11	Wrong OS version

## System Loader Error Codes

\$1101	Not found
\$1102	Incompatible OMF version
\$1104	File is not a load file
\$1105	Loader is busy
\$1107	File version error
\$1108	User ID error
\$1109	SegNum out of sequence
\$110A	Illegal load record found
\$110B	Load segment is foreign

## ProDOS 16 Filenames

A filename may contain any combination of

- capital letters A through Z
- numbers 0 through 9
- periods (.)

It must begin with a letter.

It may be up to 15 characters long.

A *volume name* follows the same rules, but also must have a preceding slash (/).

## ProDOS 16 Pathnames

A pathname is a sequence of filenames separated by slashes

A full pathname begins with a slash (and a volume name)

A partial pathname begins with a filename or a prefix number

A full or partial pathname may be up to 64 characters long (including slashes)

## ProDOS 16 Prefixes

0/	default prefix
1/	application subdirectory prefix
2/	system library prefix
3/ - 7/	(user-assigned)
*/	boot prefix

An application can change the pathname assigned to any prefix (except \*/)



## ProDOS File Types

Type	Code	Description
\$00		Uncategorized file (SOS/ProDOS)
\$01	BAD	Bad block file
\$02 †	PCD	Pascal code file
\$03 †	PTX	Pascal text file
\$04	TXT	ASCII text file (SOS/ProDOS)
\$05 †	PDA	Pascal data file
\$06	BIN	Gen. binary file (SOS/ProDOS 8)
\$07 †	FNT	Font file
\$08	FOT	Graphics screen file
\$09 †	BA3	Business BASIC program file
\$0A †	DA3	Business BASIC data file
\$0B †	WPF	Word Processor file
\$0C †	SOS	SOS system file (SOS reserved)
\$0D-\$0E †		
\$0F	DIR	Directory file (SOS/ProDOS)
\$10 †	RPD	RPS data file
\$11 †	RPI	RPS index file
\$12 †		AppleFile discard file
\$13 †		AppleFile model file
\$14 †		AppleFile report format file
\$15 †		Screen Library file (SOS reserved)
\$16-\$18 †		
\$19	ADB	AppleWorks Data Base file
\$1A	AWP	AppleWorks Word Proc. file
\$1B	ASP	AppleWorks Spreadsheet file (reserved)
\$1C-\$AF		
\$B0	SRC	APW source file
\$B1	OBJ	APW object file
\$B2	LIB	APW library file
\$B3	S16	ProDOS 16 application prog. file
\$B4	RTL	APW run-time library file
\$B5	EXE	ProDOS 16 shell application file
\$B6		ProDOS 16 permanent init. file
\$B7		ProDOS 16 temporary init. file
\$B8		New desk accessory
\$B9		Classic desk accessory
\$BA		Tool set file
\$BB-\$BE		(reserved for ProDOS 16 load files)
\$BF		ProDOS 16 document file (reserved)
\$C0-\$EE		
\$EF	PAS	Pascal area on a partitioned disk
\$F0	CMD	ProDOS 8 CI added command file
\$F1-\$F8		ProDOS 8 user defined files 1-8 (ProDOS 8 reserved)
\$F9		
\$FA	INT	Integer BASIC program file
\$FB	IVR	Integer BASIC variable file
\$FC	BAS	Applesoft program file

†SOS (Apple III) only

## ProDOS File Types (continued)

Type	Code	Description
\$FD	VAR	Applesoft variables file
\$FE	REL	Relocatable code file (EDASM)
\$FF	SYS	ProDOS 8 system program file

## Storage Type

\$0	inactive file entry
\$1	seedling file entry (EOF <= 256 bytes)
\$2	sapling file entry (256 < EOF <= 128K bytes)
\$3	tree file entry (128K < EOF < 16M bytes)
\$4	Pascal operating system area on a partitioned disk
\$D	subdirectory file entry
\$E	subdirectory header
\$F	volume directory header

## File System ID

0	(reserved)
1	ProDOS/SOS
2	DOS 3.3
3	DOS 3.2, 3.1
4	Apple II Pascal
5	Macintosh
6	Macintosh (HFS)
7	LISA
8	Apple CP/M
9-255	(reserved)

## Load File Records

Code	Name	Description
\$E2	RELOC	intra-segment relocation record
\$E3	INTERSEG	inter-segment relocation record
\$F1	DS	zero-fill record
\$F2	LCONST	long-constant record (includes all code and data)
\$F5	cRELOC	compressed intra-segment relocation record
\$F6	cINTERSEG	compressed inter-segment relocation record
\$F7	SUPER	super-compressed relocation record
\$00	END	end of the segment

# System Loader Calls

1. Push result space (as shown on *Stack Before Call*) onto the stack
2. Push input parameters (in order shown on *Stack Before Call*) onto the stack
3. Execute call block:
 

```
LDX    # $11+FuncNum | 8
JSL    Dispatcher
```

FuncNum = number of function being called  
 Dispatcher = Tool dispatcher (address = \$E1 0000)
4. On completion, results will be in order shown on *Stack After Call*

Each minor division in a stack diagram represents 1 word (2 bytes)

## \$04 Loader Version

*Stack Before Call:*

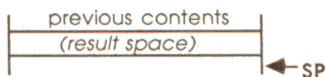

*Stack After Call:*

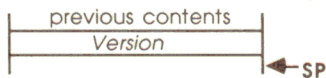

## \$06 Loader Status

*Stack Before Call:*

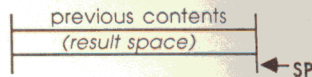

*Stack After Call:*

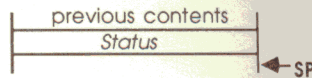

## \$09 Initial Load

*Stack Before Call:*

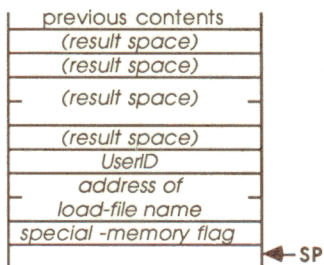

*Stack After Call:*

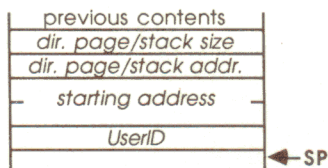

## \$0A Restart

*Stack Before Call:*

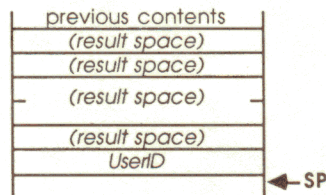

*Stack After Call:*

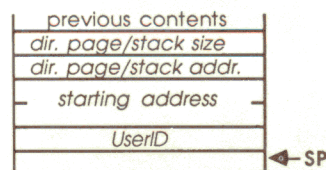

## \$0B Load Segment By No.

*Stack Before Call:*

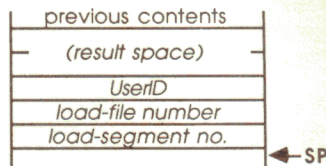

*Stack After Call:*

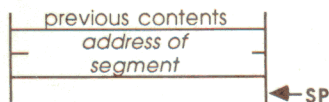

## \$0C Unload

*Stack Before Call:*

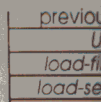

*Stack After Call:*

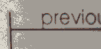

## \$0F Get Load

*Stack Before Call:*

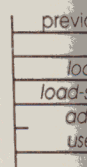

*Stack After Call:*



## \$12 User

*Stack Before Call:*

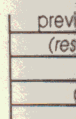

*Stack After Call:*



### \$0C

#### Unload Seg. By No.

Stack Before Call:

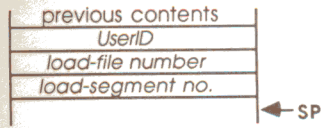

Stack After Call:



### \$0D

#### Load Seg. By Name

Stack Before Call:

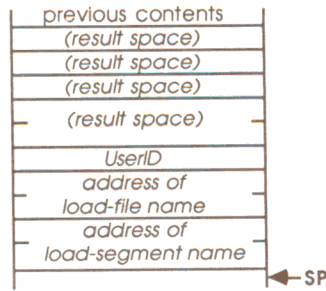

Stack After Call:

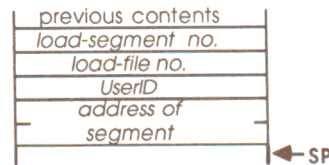

### \$0E

#### Unload Segment

Stack Before Call:

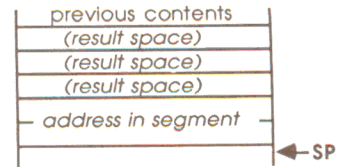

Stack After Call:

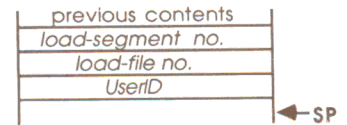

### \$0F

#### Get Load Segment Info

Stack Before Call:

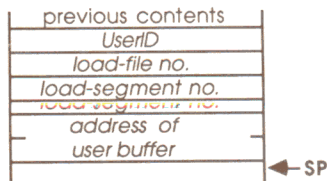

Stack After Call:



### \$10

#### Get User ID

Stack Before Call:

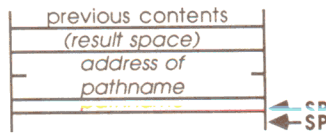

Stack After Call:

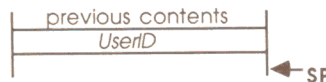

### \$11

#### Get Pathname

Stack Before Call:

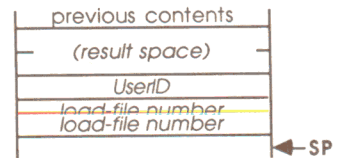

Stack After Call:

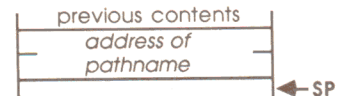

### \$12

#### User Shutdown

Stack Before Call:

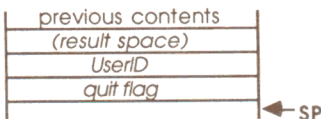

Stack After Call:

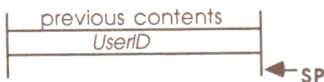





## The Official Publication from Apple Computer, Inc.

Written by the people at Apple Computer, Inc., this is the authoritative guide to the new Apple IIgs™ operating system. ProDOS® 16 is an advanced ProDOS with extended file-management, device-management, and interrupt-handling capabilities. It can launch both standard Apple® II programs and new Apple IIgs programs.

This manual gives an overview of the operating system and a detailed documentation of its programming features. Specialized topics include:

- Using the QUIT call to pass execution from one application program to another.
- Switching rapidly among applications by making them dormant and restarting them.
- Writing controlling programs such as shells and switchers.
- Writing interrupt handlers.
- Working with multiple pathname prefixes.
- Converting applications based on ProDOS 8 to work with ProDOS 16.

The *Apple IIgs ProDOS 16 Reference* is organized into four parts:

- Part I shows how ProDOS 16 works and explains how it differs from its predecessor, ProDOS 8.
- Part II describes all ProDOS 16 commands (system calls) in detail.
- Part III documents the System Loader, a flexible programming tool that loads, unloads, and manipulates program segments in memory.
- Part IV consists of appendixes, a glossary, and an index. The appendixes describe the ProDOS 16 file structure, outline the history of Apple II operating systems, explain the ProDOS 16 Exerciser disk, list all ProDOS 16 and System Loader error codes, and provide additional System Loader technical information.

A quick-reference card bound into the manual tabulates ProDOS 16 and System Loader calls, errors, and data structures. The Exerciser disk in the back pocket allows you to practice making ProDOS 16 calls before actually writing an application program.

Written for assembly-language programmers and advanced users, the *Apple IIgs ProDOS 16 Reference* is indispensable for understanding and designing Apple IIgs application programs.

**Apple Computer, Inc.**  
20525 Mariani Avenue  
Cupertino, California 95014  
(408) 996-1010  
TLX 171-576

030-3126-A  
Printed in U.S.A.

Addison-Wesley Publishing Company, Inc.

ISBN 0-201-17754-4